

Knik Arm Crossing

Engineering Feasibility and Cost Estimate Update

State Project No. 56047

Volume 2 Technology Update

Prepared for:
Alaska Department of Transportation
and Public Facilities

Prepared by:
Parsons Brinckerhoff
HDR Alaska, Inc.

In affiliation with:
Fugro West, Inc.
ASCG, Inc.
Black-Smith & Richards
Shannon & Wilson, Inc.
TY Lin International
EKM Engineering, Inc. (sub to TY Lin International)
Word Wrangling, Inc.

January 31, 2003

Knik Arm Crossing Engineering Feasibility and Cost Estimate Update

State Project No. 56047

Volume 2 Technology Update

Prepared for:

**Alaska Department of Transportation
and Public Facilities**

Prepared by:

Parsons Brinckerhoff/HDR Alaska, Inc.

In affiliation with:

**Fugro West, Inc.
ASCG, Inc.
Black-Smith & Richards
Shannon & Wilson, Inc.
TY Lin International
EKM Engineering, Inc. (sub to TY Lin International)
Word Wrangling**

January 31, 2003

1.0	INTRODUCTION.....	1-1
1.1	SOUTH APPROACH.....	1-1
1.2	KNIK ARM CROSSING.....	1-2
1.3	NORTH APPROACH.....	1-2
2.0	GEOTECHNICAL AND FOUNDATION UPDATE.....	2-1
2.1	SUMMARY.....	2-1
2.2	GEOTECHNICAL AND FOUNDATION ANALYSIS.....	2-2
2.2.1	Bridge Crossing.....	2-2
2.2.2	Ship Creek Crossing Soils.....	2-3
2.2.3	Government Hill Soils.....	2-4
2.3	SEISMIC DESIGN UPDATE.....	2-4
2.3.1	Previous Seismic Analyses.....	2-4
2.3.2	Recent Regional Seismicity.....	2-5
2.4	BRIDGE FOUNDATION CONSIDERATIONS.....	2-5
2.4.1	Piers Description.....	2-5
2.4.1.1	Subsurface Conditions.....	2-6
2.4.2	Pile Size and Hammers Considered.....	2-8
2.4.3	Methodology.....	2-8
2.5	CONCLUSIONS.....	2-9
2.5.1	Design Development Considerations.....	2-14
2.6	CONSTRUCTION CONSIDERATIONS.....	2-14
2.7	ABUTMENT AND HIGHWAY EMBANKMENT CONSIDERATIONS.....	2-15
2.7.1	Bridge Over Ship Creek.....	2-15
2.7.2	Government Hill Landslide.....	2-16
2.7.3	Cut-and Cover Tunnel through Government Hill.....	2-16
2.7.4	Port of Anchorage.....	2-17
2.7.5	Shoreline Embankment.....	2-17
2.7.6	Abutment Bluffs.....	2-18
2.7.7	Pavement Section.....	2-19
2.8	CLOSURE.....	2-20
2.8.1	Use of Design Information.....	2-20
2.8.2	Potential Variation in Subsurface Conditions.....	2-20
3.0	STRUCTURE TYPE UPDATE.....	3-1
3.1	SUMMARY.....	3-1
3.2	ANALYSIS.....	3-1
3.2.1	Hybrid Alignment.....	3-1
3.2.2	Superstructure.....	3-1
3.2.2.1	Material.....	3-3
3.2.2.2	Railroad Options.....	3-3
3.2.2.3	Road-Only Option.....	3-6
3.2.2.4	Construction.....	3-8
3.2.3	Piers.....	3-12
3.2.4	Pile Caps.....	3-13
3.2.5	Piles.....	3-17
3.2.6	Loads.....	3-18
3.2.6.1	Live Load.....	3-18
3.2.6.2	Earthquake.....	3-19

3.2.6.3	Ice.....	3-23
3.2.7	Knik Arm Oceanographic Conditions.....	3-24
3.2.7.1	Tides.....	3-24
3.2.7.2	Currents.....	3-24
3.2.7.3	Scour.....	3-25
3.2.7.4	Waves.....	3-26
3.2.8	Feasibility and Cost.....	3-26
3.2.8.1	Comparable Projects.....	3-26
3.2.8.2	Cost Breakdown.....	3-28
3.2.9	Conclusion.....	3-30
4.0	TUNNEL TECHNOLOGY AND ALTERNATIVES.....	4-1
4.1	SUMMARY.....	4-1
4.2	TUNNEL TECHNOLOGY UPDATE AND ASSUMPTION.....	4-1
4.2.1	Immersed Tube Tunnels.....	4-1
4.2.2	Soft-Ground Bored Tunnels.....	4-3
4.2.3	Tunnel Bores in Coarse-Grained Soils.....	4-6
4.2.4	Tunneling Bores in Fine- and Coarse-Grained Soils.....	4-7
4.3	TUNNEL BORING MACHINES.....	4-7
4.3.1	Slurry-Pressure Balance Machines.....	4-7
4.3.2	Earth-Pressure Balance Machine.....	4-8
4.3.3	Cutter Head Wear.....	4-9
4.3.4	Tunnel Support.....	4-9
4.3.5	Tunnel Tour.....	4-10
4.3.5.1	Tunnel Tour Findings.....	4-10
4.4	ANALYSIS.....	4-11
4.4.1	Crossing Location and Geologic Setting.....	4-11
4.4.2	Design Criteria.....	4-13
4.4.2.1	Fire and Life Safety Standards and Codes.....	4-13
4.4.2.2	Lighting Standards and Codes.....	4-13
4.4.2.3	Ventilation and Emergency Egress Standards and Codes.....	4-14
4.4.3	Tunnel Operations Assumptions.....	4-14
4.4.3.1	Operational Concept.....	4-14
4.4.3.2	Incident Impacts on Freeways.....	4-14
4.4.3.3	Incident Impacts in Tunnels.....	4-15
4.4.3.4	The Incident Management Process.....	4-15
4.4.4	Tunnel Section.....	4-19
4.4.5	Alignment and Profile.....	4-22
4.5	TUNNEL CROSSING CONSTRUCTION.....	4-23
4.5.1	Tunneling.....	4-23
4.5.1.1	Bore.....	4-24
4.5.1.2	Tunnel Support.....	4-27
4.5.2	Cross Passages.....	4-28
4.6	COST CONSIDERATIONS.....	4-28
4.6.1	Concept Designs—Based on Bored Tunnels.....	4-28
4.6.1.1	Approaches.....	4-28
4.6.1.2	Cross Passages.....	4-29
4.6.2	Primary Systems for Tunnel Ventilation.....	4-29
4.6.2.1	Conceptual Ventilation Design.....	4-29
4.6.2.2	Additional Requirements.....	4-31
4.6.2.3	Ventilation Design Parameters.....	4-32

4.6.2.4	Ventilation Equipment Parameters	4-34
4.6.2.5	Portal and Tunnel Crossing Structures.....	4-35
4.6.2.6	Ventilation Instrumentation and Control	4-35
4.6.2.7	Operations and Maintenance Centers.....	4-36
4.6.3	Fire and Life Safety Systems	4-36
4.6.3.1	Fire Detection.....	4-36
4.6.3.2	Fire Suppression and Apparatus	4-37
4.6.3.3	Closed Circuit Television.....	4-38
4.6.4	Tunnel Traffic Management Systems	4-38
4.6.4.1	General.....	4-38
4.6.4.2	Vehicle Detection.....	4-39
4.6.4.3	Variable Message Signs.....	4-39
4.6.4.4	Traffic Signals.....	4-39
4.6.4.5	Tunnel Communications	4-39
4.6.4.6	Hydrocarbon Detection	4-40
4.6.4.7	Tunnel Security.....	4-40
4.6.4.8	Tunnel Hardware and Software Systems	4-41
4.6.5	Tunnel Lighting	4-41
4.6.5.1	General.....	4-41
4.6.5.2	Lighting Levels	4-41
4.6.5.3	Light Sources	4-44
4.6.5.4	Tunnel Luminaires	4-44
4.6.5.5	Lighting Controls	4-45
4.6.5.6	Emergency Lighting.....	4-45
4.6.6	Tunnel Electrical.....	4-45
4.6.6.1	General.....	4-45
4.6.6.2	Electrical Loads.....	4-45
4.6.6.3	Electrical Supply	4-46
4.6.6.4	Electrical Supply Reliability	4-46
4.6.6.5	Electrical Power Distribution.....	4-46
4.6.6.6	Electrical Materials and Equipment.....	4-46
4.6.6.7	Emergency Power	4-47
4.7	CONCLUSIONS	4-47
5.0	REFERENCES	5-1

List of Tables

Table 2-1	Geotechnical Design Parameters: Profile 1	2-6
Table 2-2	Geotechnical Design Parameters: Profile 2	2-7
Table 2-3	Geotechnical Design Parameters: Profile 3	2-7
Table 2-4	Pile Size and Hammers Considered.....	2-8
Table 2-5	Preliminary Pile Drivability and Axial Pile Capacity Evaluations: Profile 1	2-10
Table 2-6	Preliminary Pile Drivability and Axial Pile Capacity Evaluations: Profile 2	2-11
Table 2-7	Preliminary Pile Drivability and Axial Pile Capacity Evaluations: Profile 3A ...	2-12
Table 2-8	Profile 3B (Boring B-5).....	2-13
Table 4-1	Incident Management Process System Equipment.....	4-17
Table 4-2	Tunnel Design Components	4-21
Table 4-3	Ventilation Design Parameters	4-32
Table 4-4	Tunnel Lighting Design Criteria.....	4-42
Table 4-5	Approach Zone Lighting Design Criteria	4-42
Table 4-6	Threshold Zone Lighting Design Criteria.....	4-42
Table 4-7	Transition Zone Lighting Design Criteria	4-43
Table 4-8	Interior Zone Lighting Design Criteria	4-43
Table 4-9	Nighttime Luminance Lighting Design Criteria	4-43
Table 4-10	Uniform Ratio Lighting Design Criteria.....	4-44

List of Figures

(on or following page)

Figure 1.1	Hybrid Alignment Location Map	1-1
Figure 2.1	Elmendorf Crossing.....	2-2
Figure 2.2	Hybrid Alignment Section.....	2-2
Figure 2.3	Hybrid Alignment Section.....	2-2
Figure 2.4	Hybrid Alignment Section.....	2-2
Figure 2.5	Hybrid Alignment Section.....	2-3
Figure 2.6	Epicenters of Mw = 3.0 to 5.5 Earthquakes Recorded within 120 km of Anch	2-5
Figure 2.7	Epicenters of Mw >5.5 Earthquakes Recorded within 120 km of Anchorage	2-5
Figure 2.8	Ship Creek Overpass Pile Recommendations.....	2-15
Figure 2.9	Hybrid Alignment Section.....	2-17
Figure 2.10	Suggested Buttress Configuration	2-18
Figure 2.11	East Side Abutment Treatment.....	2-19
Figure 3.1	Hybrid Alignment.....	3-1
Figure 3.2	Water Depth.....	3-2
Figure 3.3	Extradosed Structure.....	3-2
Figure 3.4	Railroad Inside Box Girder.....	3-4
Figure 3.5	Railroad Inside Bridge Elevation.....	3-4
Figure 3.6	Railroad on Top Bridge Elevation.....	3-4
Figure 3.7	Railroad on Top of Box Girder.....	3-5
Figure 3.8	Separate Structure for Railroad	3-6
Figure 3.9	Road Only Bridge Elevation.....	3-6
Figure 3.10	Road-Only Box Girder	3-7
Figure 3.11	Heavy-Lift Construction (Jamestown-Verrazanno Bridge).....	3-8
Figure 3.12	Cross Section for Heavy Lift	3-9
Figure 3.13	Post Tensioning with Heavy-Lift Construction.....	3-9
Figure 3.14	The Balanced Cantilever Method of Construction	3-10

Figure 3.15	The Balanced Cantilever Method of Construction (Sun Yat-Sen Freeway).....	3-10
Figure 3.16	Arrangement of Cantilever Tendons	3-11
Figure 3.17	Casting of Closure Segment (Kramer-Rosecrans Bridge).....	3-11
Figure 3.18	Pier Section.....	3-12
Figure 3.19	Reinforcement of Pier (San Francisco-Oakland Bay Bridge Section).....	3-13
Figure 3.20	Pile Cap Elevation	3-14
Figure 3.21	Pile Cap Plan	3-15
Figure 3.22	Pile Cap Section.....	3-16
Figure 3.23	Alternative Pile Cap.....	3-16
Figure 3.24	Precast Pile Cap Shells (Jamuna River Bridge).....	3-17
Figure 3.25	Large-Diameter CISS Pile (San Francisco-Oakland Bay Bridge).....	3-18
Figure 3.26	Cooper E80 Live Load	3-19
Figure 3.27	Response Spectrum for 2,500-Year Event.....	3-20
Figure 3.28	San Francisco-Oakland Bay Bridge Design Spectra ($g=9.8 \text{ m/s}^2$)	3-20
Figure 3.29	Response Spectrum for 100-Year Event.....	3-22
Figure 3.30	Location of Plastic Hinges in Piers.....	3-22
Figure 3.31	Confederation Bridge	3-26
Figure 3.32	Benicia-Martinez Bridge	3-27
Figure 3.33	San Francisco-Oakland Bay Bridge.....	3-27
Figure 3.34	Jamuna River Bridge	3-28
Figure 3.35	Typical Cost Breakdown (from Schlaich and Scheef, 1982).....	3-29
Figure 3.36	Cost Ratios for Major Water Crossings.....	3-29
Figure 4.1	Increased Size of Bored Tunnels	4-4
Figure 4.2	Tunnel Support Systems.....	4-6
Figure 4.3	Crossing Foundation Conditions	4-12
Figure 4.4	Tunnel Incident Management Process.....	4-16
Figure 4.5	Twin Tunnel Cross Section	4-20
Figure 4.6	Stacked Tunnel Cross Section with Reduced Shoulders	4-21
Figure 4.7	Tunnel Profile	4-22
Figure 4.8	Tunnel Profile Through Geology	4-23
Figure 4.9	Tunnel Boring Machine—Slurry Shield Cut Away	4-25
Figure 4.10	Slurry Pressure Boring Method	4-26
Figure 4.11	Tunnel Systems Schematic	4-28
Figure 4.12	Tunnel Control Center Concepts	4-28
Figure 4.13	Standard Cross Sections	4-28
Figure 4.14	Reduced Cross Section	4-28
Figure 4.15	Schematic of Tunnel Alternatives, Ventilation Design	4-29
Figure 4.16	Mid-Tunnel Ventilation Shaft	4-30
Figure 4.17	Tunnel Lighting Zones	4-41

1.0 INTRODUCTION

As outlined in Volume 1, the Alaska Department of Transportation and Public Facilities (ADOT&PF) is conducting this Knik Arm Crossing Engineering Feasibility and Cost Estimate Update Project (Update Project) to provide a preliminary examination of historical and current planning, engineering, and cost factors for the purpose of updating the engineering feasibility and cost estimate components of the project. A literature search update was conducted for the Knik Arm Crossing project to determine a Knik Arm Crossing alignment that best meets the project objective of transportation improvements, and can be used as a basis for developing an opinion of cost that represents the probable range of costs for the project. This project update did not attempt to identify a preferred alternative. From the review of historical Knik Arm Crossing documents and research of physical changes, land uses, new technologies, and issues and concerns, a general alignment was identified that will be used as a basis for developing planning-level cost estimates to represent approximated funding needs for future project budgeting and work-programming purposes. The alignment is identified as the Hybrid Alignment and is shown in **Figure 1.1**.

The Hybrid Alignment includes four basic segments: the south approach (Anchorage Connector), the Knik Arm crossing, and the north approach divided into two segments (Matanuska-Susitna [Mat-Su] Borough Connector). The total length of the Hybrid Alignment is approximately 36.5 miles.

1.1 South Approach

The south approach extends from the vicinity of 3rd Avenue and Ingra-Gambell streets in downtown Anchorage northward to the Port of Anchorage (POA) and is approximately 1.8 miles in length. This segment consists of a combination alignment of the 1984 Bluff Project from the Draft Environmental Impact Statement (DEIS) (ADOT&PF and U.S. Federal Highway Administration [FHWA]) and the 1999-2000 Municipality of Anchorage (MOA) POA and Ship Creek transportation alignment studies.

This alignment begins with an extension of the Ingra-Gambell one-way pair couplet at 3rd Avenue northward across the former Alaska Native Hospital property to the vicinity of the south bluff of the Ship Creek Railyard. The extension transitions into a merged section at this point and connects to a pier-supported viaduct section, spanning the Ship Creek Railyard with a minimum 50-foot vertical clearance. The viaduct section is approximately 0.48 mile in length. Ramp connections may be added within this viaduct section during future engineering evaluations to provide access to the Railyard to support Ship Creek development plans. Proceeding north, the viaduct section transitions to a two-level, cut-and-cover tunnel under Government Hill that aligns approximately with Degan Street. The tunnel is approximately 0.13 mile or 700 feet in length. The south approach then extends from the north end of the tunnel at Government Hill and aligns with Terminal Road, following the east boundary of the POA and west boundary of Elmendorf Air Force Base (AFB) to the northern vicinity of the POA.

Knik Arm Crossing Engineering Feasibility and Cost Estimate Update

Figure 1.1

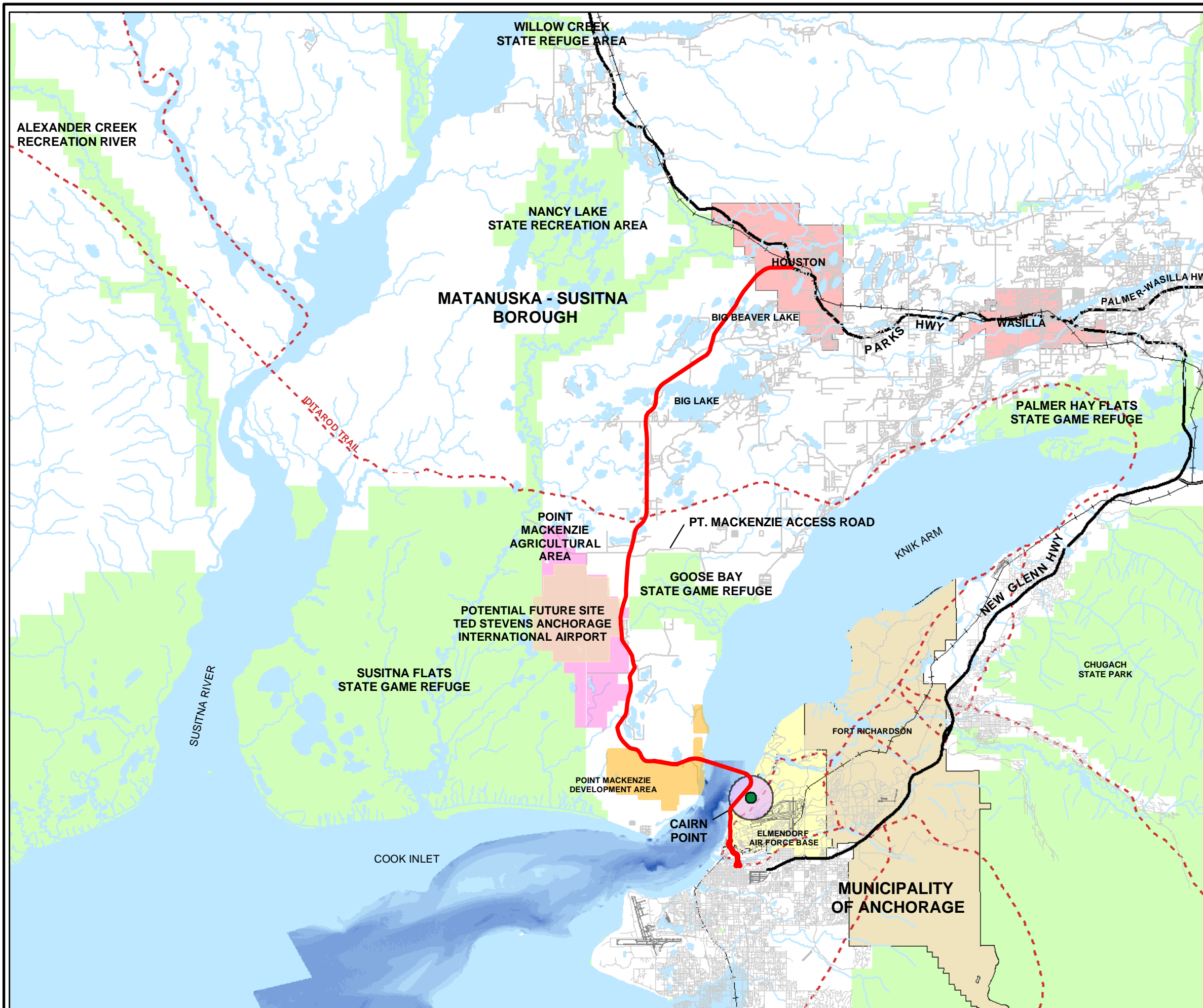

Legend

- Hybrid Alignment
- Elmendorf Antenna Location
- - - Trails
- Roads
- +— Railroad
- City Limits
- Refuges

Depth (meters)

0
1 - 5
5 - 10
10 - 15
15 - 20
20 - 25
25 - 30
30 - 35
35 - 40
40 - 45
45 - 50
50 - 55
55 - 60

Data compiled by HDR Alaska, Inc. September 2002

Source of data from:
Municipality of Anchorage,
Matanuska-Susitna Borough,
Department of Natural Resources,
USGS

Map is projected to Alaska Stateplane Zone 4, NAD 27.



1.2 Knik Arm Crossing

The Hybrid Alignment crossing of the Knik Arm segment extends from the POA on the east side of Knik Arm to the existing Point MacKenzie Access Road in the Mat-Su Borough on the west side of Knik Arm, a distance of approximately 5.9 miles. The roadway aligns along the east bluff of Knik Arm from the POA to approximately 1.7 miles north of Cairn Point. This section is approximately 2.5 miles in length. From this point, the alignment crosses Knik Arm in a general east-west direction. The crossing of Knik Arm includes the evaluation of both a bridge structure and a tunnel alternative. The actual crossing of Knik Arm is approximately 2.6 miles in length.

1.3 North Approach

The Hybrid Alignment for the north approach in the Mat-Su Borough includes the preferred alternative from the 1984 DEIS, identified as the Houston Connector. Both the Downtown Anchorage/Houston (Downtown) Alternative and the Elmendorf AFB/Houston (Elmendorf) Alternative, which were recommended alignment alternatives from the 1984 DEIS, included the Houston Connector as a common alignment connector in the Mat-Su Borough. The Houston Connector, approximately 28.7 miles in length, includes the following:

- Ayshire: an 11.7-mile, limited-access roadway from the west end of the Knik Arm Crossing to the east-west segment of the Point MacKenzie Access Road, basically following the existing alignment of the Point MacKenzie Access Road
- North: a 17-mile, limited-access roadway from the east-west segment of Point MacKenzie Access Road north to the Parks Highway at the City of Houston

The Houston Connector includes a 400-foot-wide, limited-access right-of-way (R/W) throughout this segment to provide adequate width for future inclusion of additional travel lanes, a path for non-motorized vehicles or pedestrians, future utilities, frontage roads, future upgrading to full-grade separated interchanges, and buffer space to protect adjacent land uses from roadway noise and visual impact.

In this study, geotechnical and foundation issues, structure and tunnel technology, types, and alternatives are discussed for a crossing of the Knik Arm along the Hybrid Alignment.

2.0 GEOTECHNICAL AND FOUNDATION UPDATE

2.1 Summary

This chapter presents the results of a review and evaluation of available geotechnical data in support of an engineering feasibility and cost estimate update for the Knik Arm Crossing project. The purpose of this review is to provide baseline foundation recommendations along a hybrid corridor to aid in determining the approximate cost to construct the main over-water bridge, the adjoining highways, and other support structures. The Hybrid Alignment starts at Ingra Street and Fourth Avenue in Anchorage and travels north across the Ship Creek drainage, through Government Hill, along the east edge of the POA, and up the Knik Arm shoreline about two miles to the bridge crossing location. The bridge crosses Knik Arm through average water depths of 60 to 70 feet and elevates gradually to the 125-foot-high west bank and extends west and north to merge with the existing road system.

The geotechnical review consisted of two major components: (1) the bridge and (2) the onshore roads and railway and other support structures needed to connect the bridge to the existing road system. The over-water bridge crossing will be one of the more challenging parts of a Crossing project. Analysis indicates that eight- to ten-foot-diameter, high-capacity pipe piles driven into the hard or dense glacial deposits would be a preferred means of developing deep foundations for the 25 to 30 piers. Although very large derrick barges and hydraulic hammers would be needed to handle and drive these piles, the number of piles per pier would be three to four times fewer than the number of medium-size piles (four foot diameter) that would need to be installed. Additionally, the field construction time to install the fewer piles would be greatly compressed. The pier foundation pile cap for the fewer piles would also be much smaller, resulting in smaller lateral forces on the piers in the intertidal zone.

To achieve ultimate pile capacities in the range of 15,000 to 20,000 kips per pile, 8-foot-diameter piles approaching 200 to 300 feet in length would be needed with a wall thickness in the 2.5-inch range. In addition to the specialty driving equipment, splicing the long piles and thick walls, achieving suitable penetration (hard driving) in the glacial soils, penetrating possible boulders, and drilling out soil in the piles are all construction challenges associated with the over-water bridge foundation work. Regardless of the diameter size selected for piles, further construction challenges include the harsh environment of large tides and currents, strong winds, sea ice, cold winters, and water with poor visibility. A test pile program would be recommended as part of the design process to give contractors confidence concerning the labor and difficulties associated with installing these piles.

A weak link encountered in the current geotechnical review of the bridge crossing site was the lack of deep-boring data beneath the east half of the channel. The existing borings were not deep enough to determine whether the soils at depth are sands and gravels (till-like soils) or clays (Bootlegger Cove clays). This data gap significantly affects a reliable determination of pile lengths in this area. The pile lengths in this east segment could be 50 or 100 feet shorter if the granular till soils that dominate this region

are present and the clays are thin or absent. As described in this report, additional geotechnical studies will be needed both in the over-water areas and onshore for final design.

To connect the bridge to the existing road and rail systems, a significant component of the project is the on-land and shoreline construction work, which involves an overpass bridge across Ship Creek, a cut-and-cover tunnel through Government Hill, four-lane roads through several old landslides, and shoreline embankments with toe buttresses, riprap faces, and special features for slope drainage control. Additionally, the bridge abutments will penetrate or merge with high, steep bluffs at the ends and must be treated to stop the natural erosion process in each area. The locations of the various features and recommended soil parameters for sizing each structure are presented in the subsequent text and figures.

2.2 GEOTECHNICAL AND FOUNDATION ANALYSIS

The anticipated soil conditions and design challenges along the main bridge crossing are briefly presented below, followed by similar discussions of expected conditions for most of the onshore alignment.

2.2.1 Bridge Crossing

The subsurface conditions in the vicinity of the water crossing have been characterized by the profile in **Figure 2.1**. This section, defined as the Elmendorf Crossing, was taken from Plate 5 of a 1984 report on geologic and geotechnical considerations of a Crossing Project (Harding Lawson Associates [HLA], 1984) and was modified to include recent subsurface information from the nearby Port MacKenzie Dock Project and reconnaissance mapping and exploration of the bluffs and off-shore conditions in 1970 and 1971. Soil units were also extrapolated into areas where conditions are not well defined on this profile and represent assumed conditions that were needed to develop construction costs in these areas. Although this longitudinal section is not the exact hybrid alignment longitudinal section as shown in **Figures 2.2** through **2.4**, it crosses the hybrid section and falls to the south on the west bank and to the north on the east bank. Therefore, except possibly for minor length differences, the **Figure 2.1** profile is assumed to reasonably represent subsurface conditions at the hybrid longitudinal section, and furthermore is the best over-water subsurface information available in this vicinity.

In summary, the **Figure 2.1** profile shows a surficial marine deposit of 20 to 35 feet of loose to medium-dense sands overlying very dense granular tills or glacio-fluvial deposits or hard clays and silts. Previous studies indicate that the looseness of marine-deposited sands in the upper 35 feet will cause them to liquefy under strong earthquake shaking; therefore, the sands should not be relied on for foundation support. The deeper soils are likely not prone to strength losses under seismic loading and are suitable for support of piers with the use of deep foundations. The thick clay or sand and gravel unit below the east half of the crossing (or the red zone in **Figure 2.1**) is based on geologic and geophysical interpretations and has not been confirmed by borings. What is actually present can have a large impact on the feasibility and cost of a bridge foundation

MAT-SU BOROUGH

ELMENDORF AFB

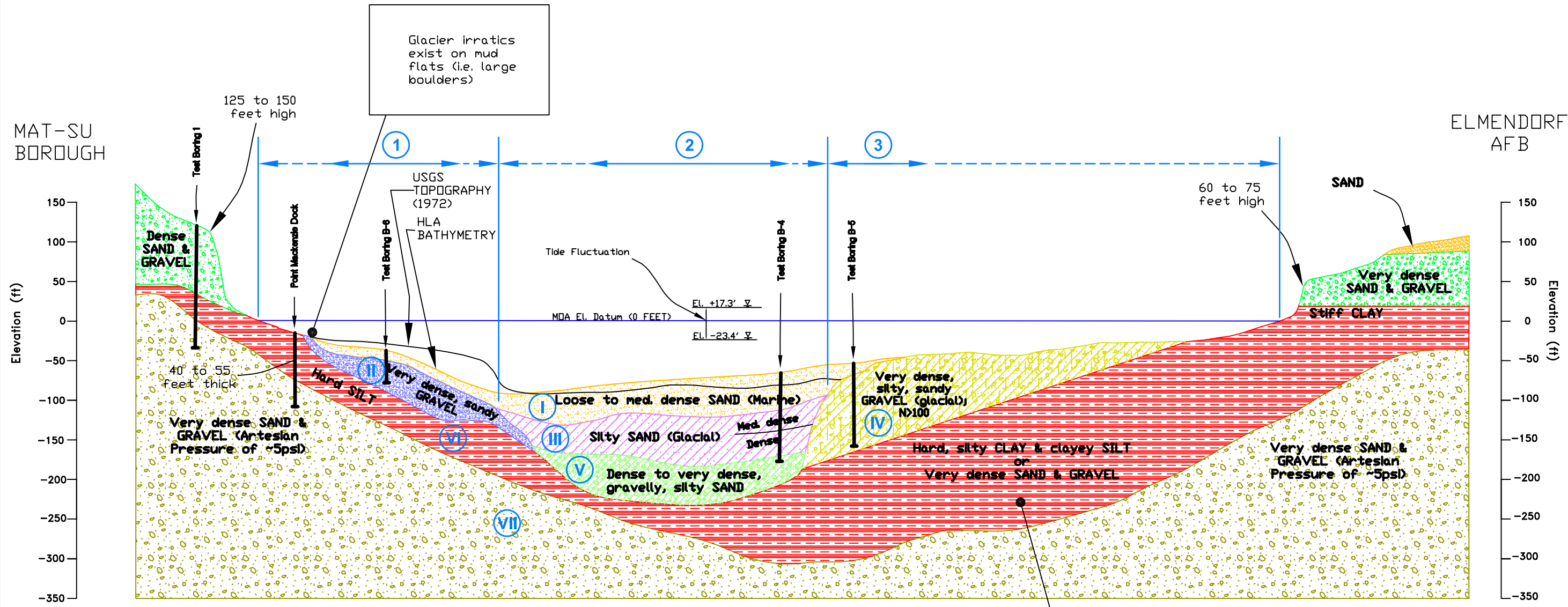

KEY TO FUGRO ANNOTATIONS

- ① Representative Soil Profile
- I Soil Strata

Note:
Unit determined based on geology and geophysics and not actually confirmed with borings in this part of the section

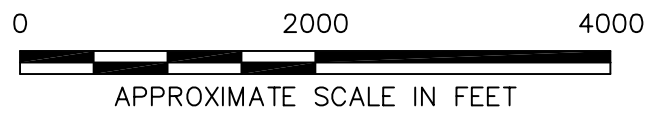

Knik Arm Bridge Project
Anchorage, Alaska

ELMENDORF CROSSING

October 2002 32-1-01536

SHANNON & WILSON, INC.
Geotechnical & Environmental Consultants

FIG. 2.1

Modified cross section from HLA, 1984

2002\1180.007\1536profile.dwg(1.2),1536profile.ctb



STATE OF ALASKA
DEPARTMENT OF TRANSPORTATION
AND
PUBLIC FACILITIES
KNIK ARM CROSSING
ENGINEERING FEASIBILITY AND
COST ESTIMATE UPDATE

FIGURE 2.2

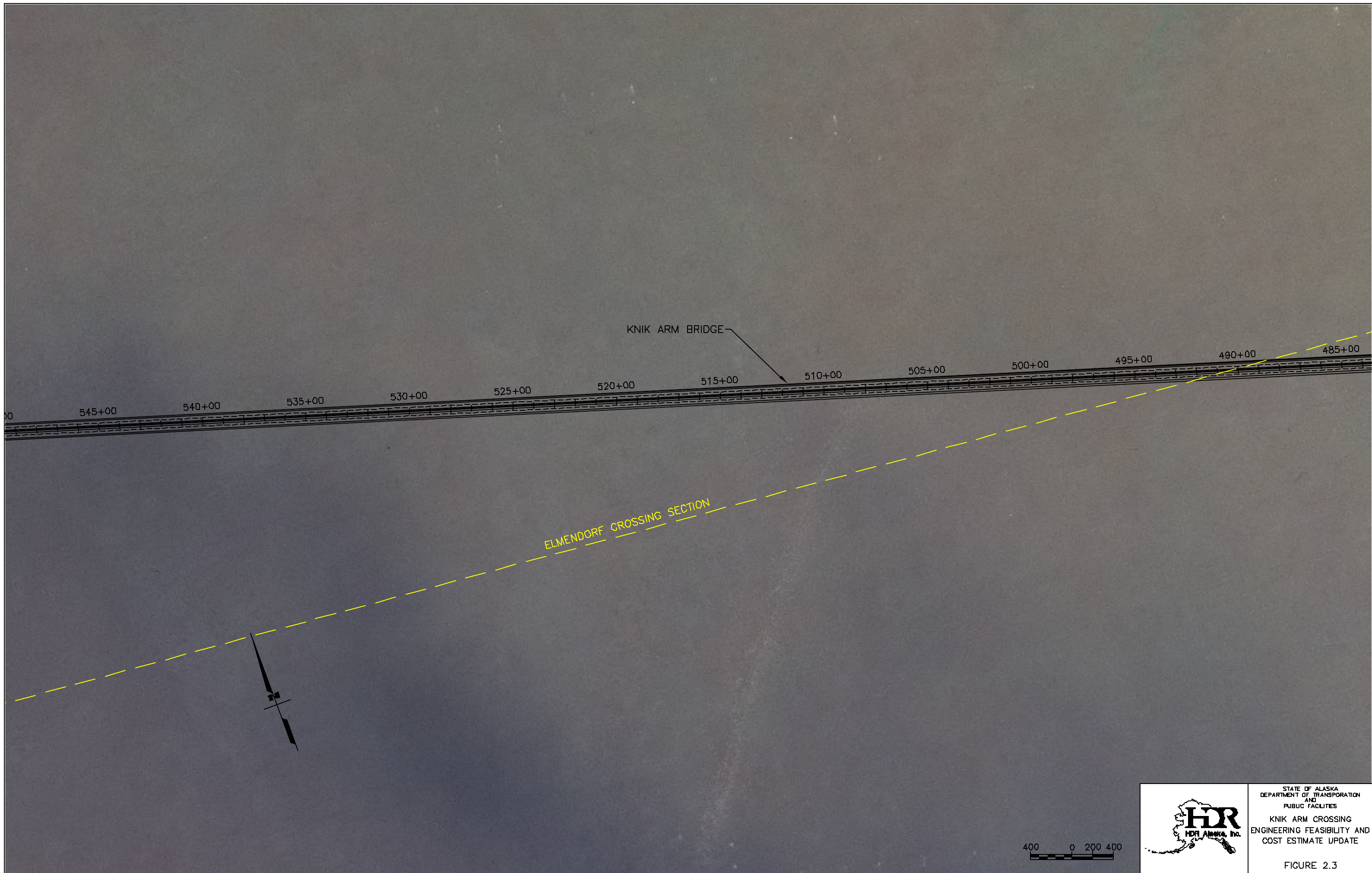

KNIK ARM BRIDGE

545+00 540+00 535+00 530+00 525+00 520+00 515+00 510+00 505+00 500+00 495+00 490+00 485+00

ELMENDORF CROSSING SECTION

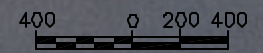

STATE OF ALASKA
DEPARTMENT OF TRANSPORTATION
AND
PUBLIC FACILITIES
KNIK ARM CROSSING
ENGINEERING FEASIBILITY AND
COST ESTIMATE UPDATE

FIGURE 2.3

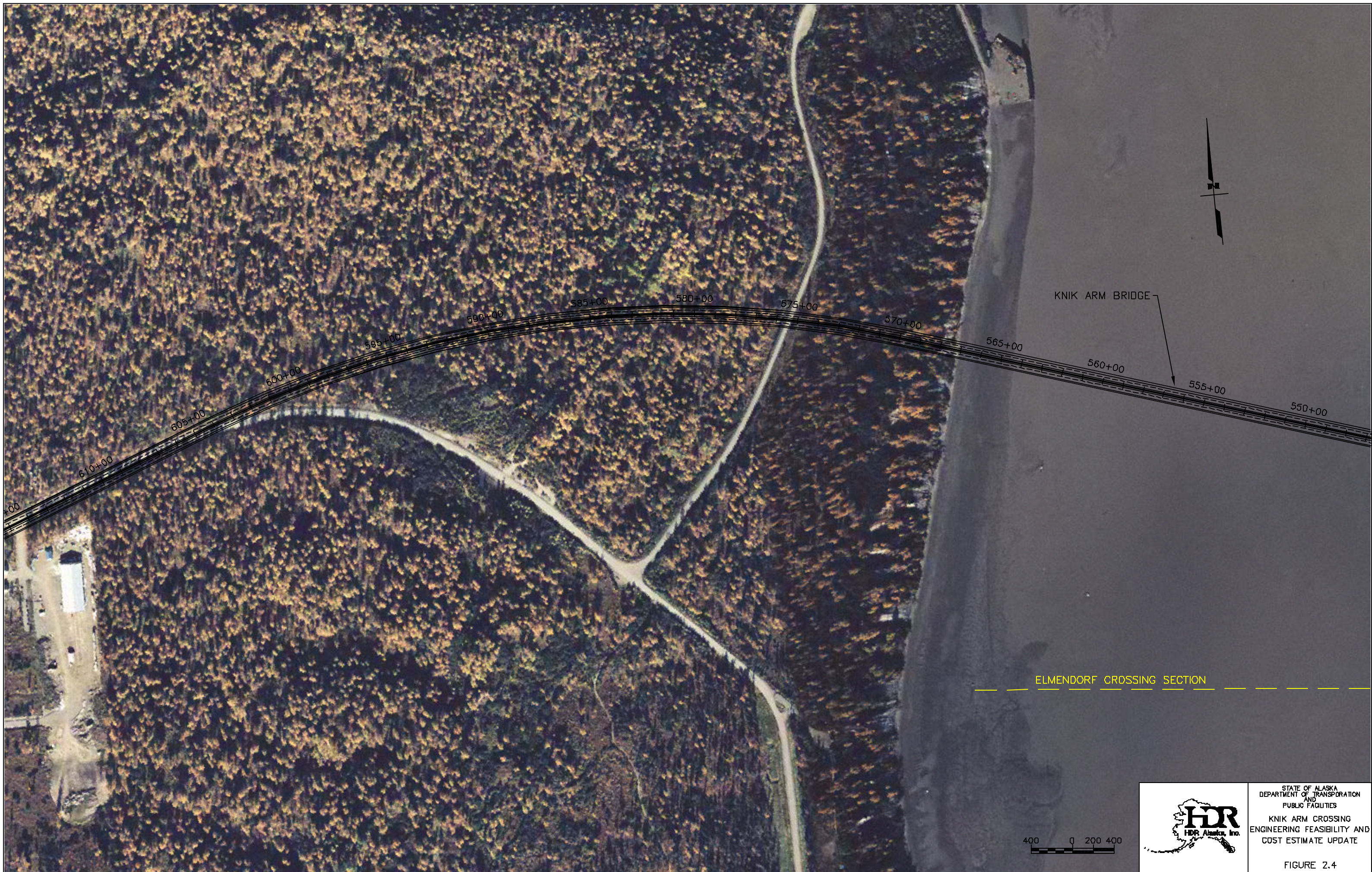

KNIK ARM BRIDGE

ELMENDORF CROSSING SECTION

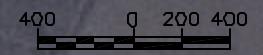

STATE OF ALASKA
DEPARTMENT OF TRANSPORTATION
AND
PUBLIC FACILITIES
KNIK ARM CROSSING
ENGINEERING FEASIBILITY AND
COST ESTIMATE UPDATE

FIGURE 2.4

construction at this location. If clay is present, it can affect the length of the high-capacity piles needed to support a bridge (the piles will be much longer than if it were glacial sands and gravels).

A second note on the profile indicates that glacial erratics (large boulders) are visible on the mudflats at low tide near the Port MacKenzie Dock and in photographs in the Dames & Moore seismic survey report (1970). This indicates that large boulders are present within the glacial tills and moraine deposits as well as potentially, but infrequently, in the clays. Their presence could affect pile-driving operations, primarily the ability to obtain adequate pile-embedment depths.

The tides in Cook Inlet (shown on the profile in **Figure 2.1**) are large (40.7 feet maximum); the currents approach or exceed seven knots; and during winter, cold temperatures, winds, and sea ice make over-water construction difficult. The strong currents, water temperatures, and poor visibility also limit the use of divers for underwater work.

2.2.2 Ship Creek Crossing Soils

As summarized above and presented on the site plan, **Figure 2.5**, the highway corridor traverses north from the Ingra-Gambell couplet several blocks to the south bluff of the Ship Creek drainage. At this bluff, the roadway passes through the old First Avenue Slide, a portion of the slope that failed during the 1964 Alaska Earthquake. This slope and road segment, which has been studied by MOA-funded designs developed by Lounsbury & Associates, entails lowering the crest of the failed bluff at the former Alaska Native Hospital site to improve the stability of the slope and using the excavated clean granular soils in the upper part of the slope as embankment fill elsewhere. The soil conditions in this bluff area are contained in Shannon & Wilson reports (1964, 1994, and 2001b).

To reflect conditions in the large drainage, deep borings were drilled by the ADOT&PF in 1966 for the adjacent A Street Bridge over Ship Creek, shown in **Figure 2.5**. The soils encountered in these borings largely consisted of about 15 to 25 feet of loose to dense gravelly sands overlying medium to very stiff, silty clay (mostly stiff) with very dense sands and gravels roughly 160 feet (about Elevation -145 feet) below the valley bottom. At the north and south bank of the drainage way, the deeper bearing stratum occurs at about Elevations -80 and -60 feet, respectively (Shannon & Wilson, 1964), and the clays appear to range from soft to stiff (Shannon & Wilson, 2001b). Similar to the A Street Bridge, support of this new overpass structure will likely require mostly pile-supported piers that derive pile support in skin friction in the clays or end bearing in the deep granular unit.

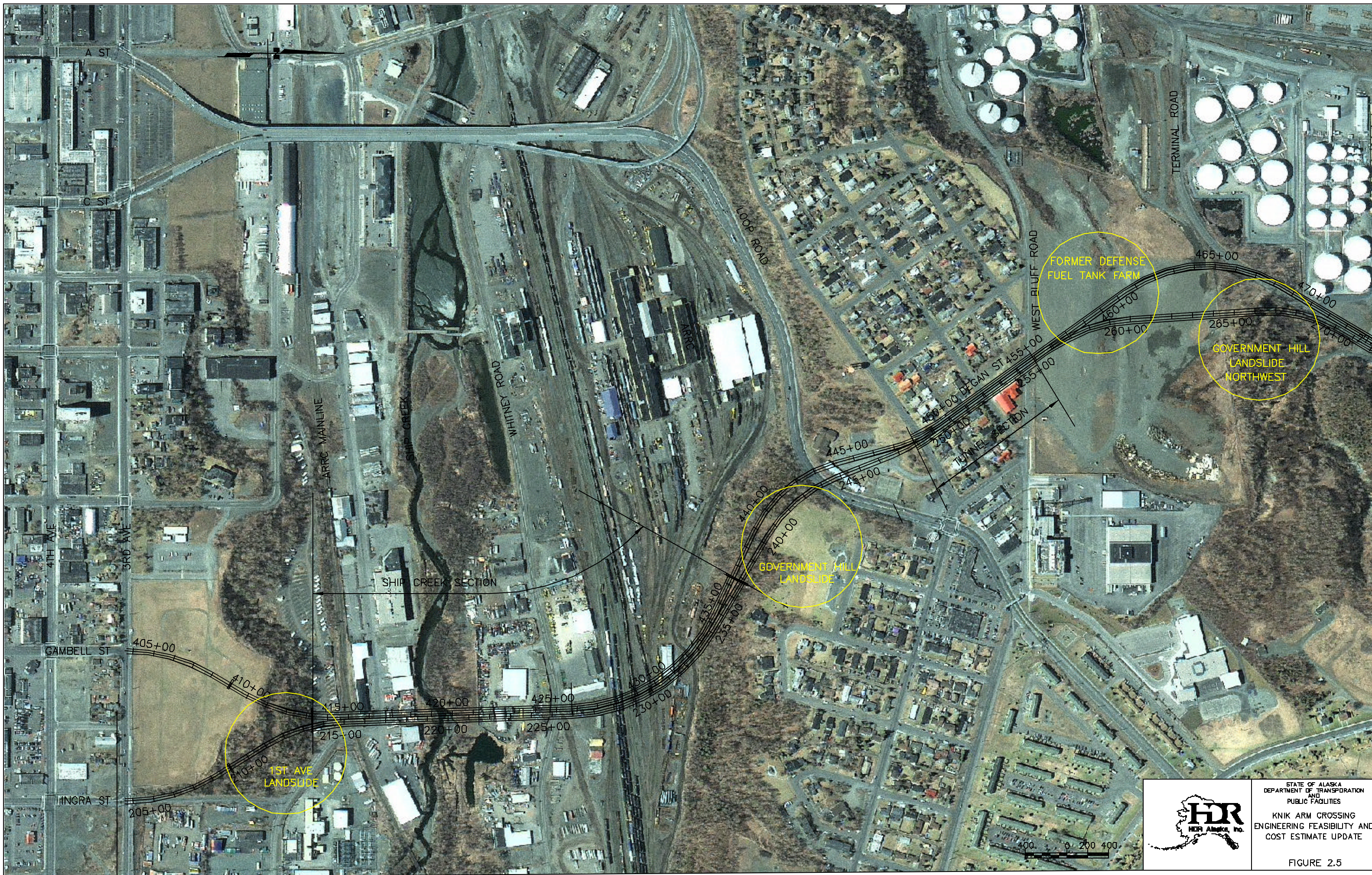

	STATE OF ALASKA DEPARTMENT OF TRANSPORTATION AND PUBLIC FACILITIES
	KNIK ARM CROSSING ENGINEERING FEASIBILITY AND COST ESTIMATE UPDATE
FIGURE 2.5	

2.2.3 Government Hill Soils

As the alignment approaches the north bluff of Ship Creek and Government Hill, it bends west along the 60-foot bluff and aligns through the site of the old Government Hill Landslide (Shannon & Wilson, 1964), a segment of slope that failed in the 1964 Alaska Earthquake. This landslide area is shown in **Figure 2.5**. Slope failure occurred through the upper 40 feet of sands and gravels and toed in the weaker and locally sensitive clay soils found in the lower parts of the slope. The multilanes that traverse this slide will require both slope flattening and terracing, and possibly a toe buttress in this area.

The soils forming Government Hill consist of 25 to 60 feet of medium to dense clean outwash gravels and sands to roughly Elevation +60 feet overlying medium to stiff clays with varying depths of groundwater perched on the clays and in the clean granular soils. The granular soils are from the Naptowne Outwash Formation, and the clays are part of the Bootlegger Cove Formation. For the above conditions and the tunnel section shown in plan in **Figure 2.5**, the anticipated elevation of the tunnel crown would fall mostly in the granular outwash materials where running ground and piping conditions have been experienced when tunneling in similar outwash soils in Anchorage. Given those conditions, a tunnel constructed in a braced or tied back anchor trench will work well for penetrating this hill.

At the south portal area or the tunnel entrance, the slope is locally steep and was generally stable during the 1964 Alaska Earthquake. In this region, the overlying granular soils are similar to those characterizing most of Government Hill and are underlain by the previously described clays.

Beyond the northwest portal or egress, the alignment passes through the 17-acre former Defense Fuel tank farm area where the slopes are relatively gentle and where stability is not expected to present a concern. Depending on the road location, some petroleum-contaminated soils from spills and leaks in this former tank site may be encountered in this region and may have to be dealt with during construction as the ground is regraded to accommodate the four traffic lanes that will traverse this property. Because this site, shown in **Figure 2.5**, has been well studied (Shannon & Wilson, 1997), areas of contamination and the soil and groundwater conditions are well defined from more than 100 borings at the site.

2.3 SEISMIC DESIGN UPDATE

The seismic conditions associated with the Knik Arm Crossing were reviewed in an updated seismic analysis by HLA that considered the seismic analysis on the nearby Anchorage courthouse addition performed by Woodward-Clyde Consultants (WCC).

2.3.1 Previous Seismic Analyses

The thorough, regional seismicity analysis of the Knik Arm Crossing area performed in 1984 (HLA) was particularly useful for its description of subsurface conditions for seismic analysis and its framing of the particular faults and their relative activity. The

spectral-response curves recommended provided insight and guidance for the current recommendations.

In 1987, WCC covered in detail some of the objective seismic hazards associated with ground shaking in the area. Of note is the residual strength analysis on the Bootlegger Formation, which may be as pertinent to this project as it was to the courthouse. Along with appropriate consideration of the static and residual strengths of weak soils that also may exist at the Knik Arm Crossing, WCC carried out a seismic stability analysis and an assessment of permanent ground deformations. That information may be useful in considering slope stability and ground deformations at or near the Crossing that may influence any future structure located there.

2.3.2 Recent Regional Seismicity

The HLA 1984 report considered regional seismicity from 1898 to 1984 over a geographic reach within 75 miles (120 km) of Anchorage. Epicentral plots were shown for various moment magnitude bins. Updated plots, **Figures 2.6** and **2.7**, show the recent seismicity in the same region for 1984 to the present. **Figure 2.6** has epicentral locations for earthquakes with moment magnitudes of 3.0 to 5.5. As the figure shows, there have been numerous (1,727) small-magnitude events in the intervening 18 years. **Figure 2.7** shows the epicentral locations of earthquakes with moment magnitudes greater than 5.5. The epicenters on this figure correspond to 11 earthquakes of moment magnitudes less than 6.0 and one event of a moment magnitude 6.4. All events in **Figure 2.7** have relatively shallow focal depths. This shallow focal depth does not correspond to the depth of the 1964 intraplate event.

2.4 BRIDGE FOUNDATION CONSIDERATIONS

The key components of this project include the foundations for the main bridge crossing Knik Arm and the approach roads with smaller structures to tie the project into the existing road system. This section summarizes pile-capacity evaluations and installation considerations for large-diameter pile foundations for the over-water portion of the bridge. The discussion focuses on determining the most likely foundation system and developing preliminary recommendations to aid the team in developing a rational construction cost estimate for the project.

2.4.1 Piers Description

The bridge concept currently under consideration is a precast-concrete box-girder bridge that will be designed as structural frames with approximately four to six piers per frame. The bridge pier spacing is anticipated to be on the order of 500 feet with footings that act as pile caps within the intertidal zone. The structural design has used foundation concepts that include relatively few large-diameter steel pipe piles in each of the 25 or more piers.

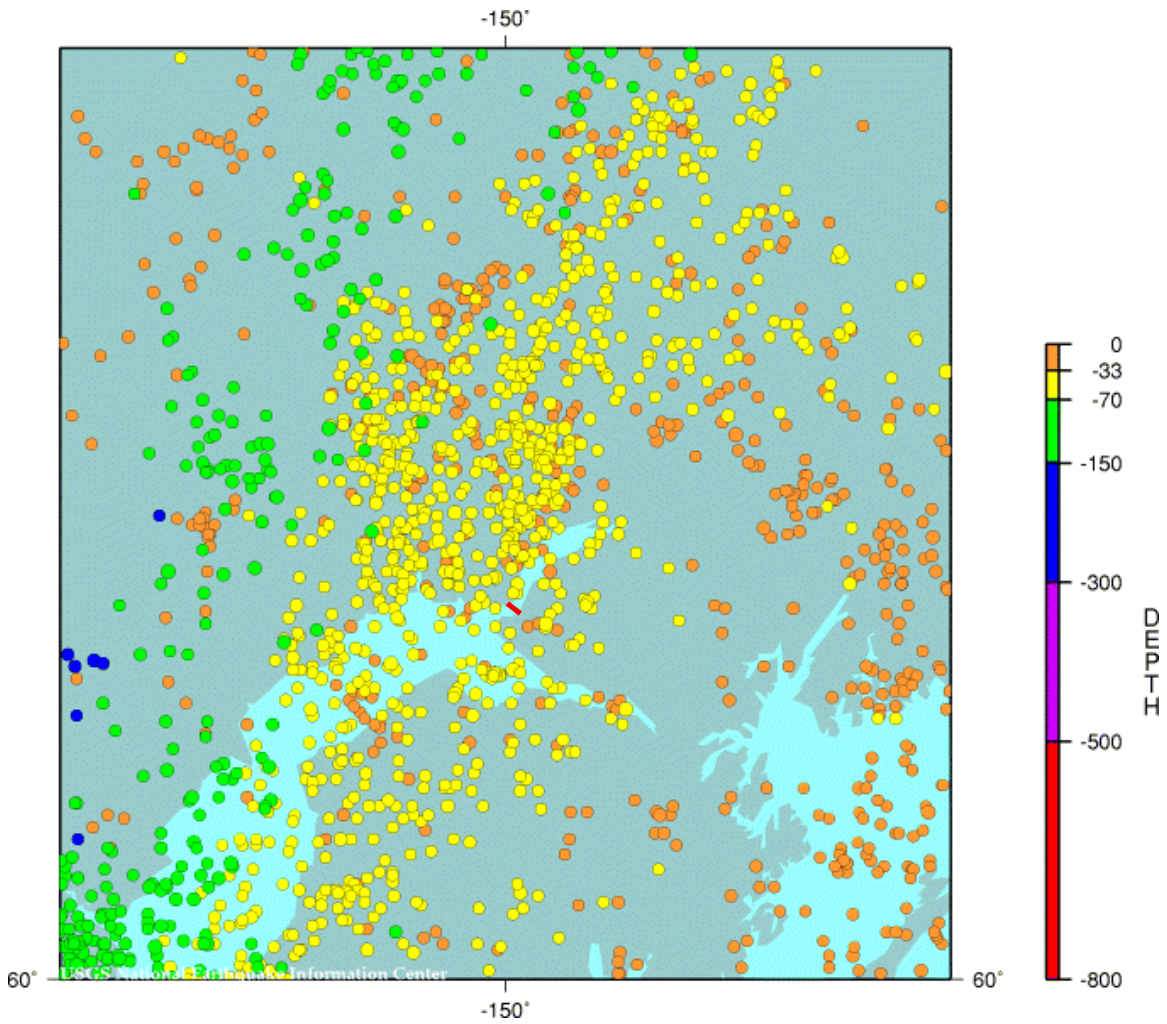

◆ = Approximate location of Knik Arm Crossing.

**EPICENTERS OF $M_w = 3.0$ TO 5.5 EARTHQUAKES RECORDED WITHIN
120 KILOMETERS OF ANCHORAGE (1984-PRESENT)**
Knik Arm Crossing

FIGURE 2.6

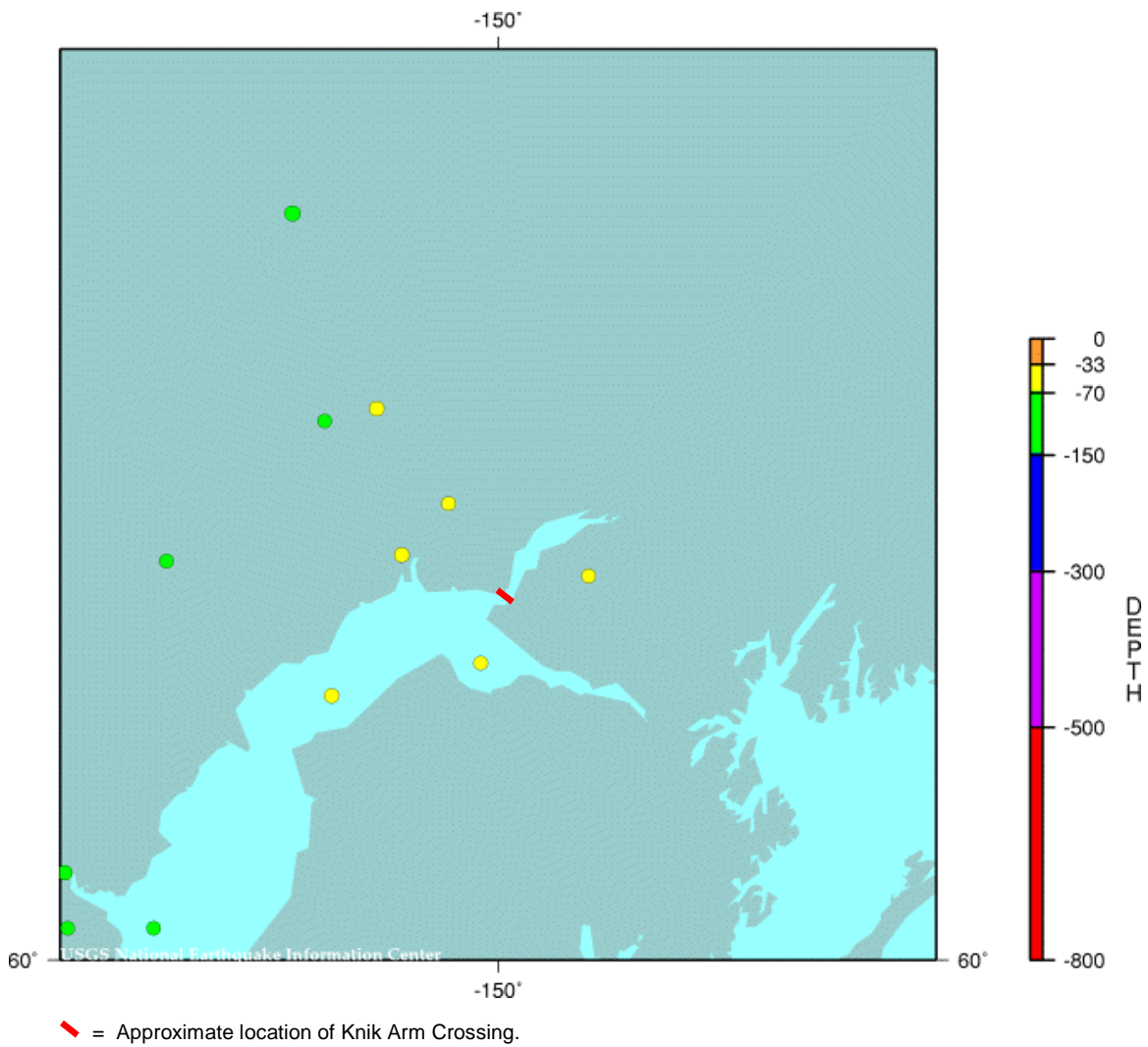

**EPICENTERS OF $M_w > 5.5$ EARTHQUAKES RECORDED WITHIN
120 KILOMETERS OF ANCHORAGE (1984-PRESENT)**
Knik Arm Crossing

FIGURE 2.7

2.4.1.1 Subsurface Conditions

As discussed above, relatively little subsurface geotechnical data are available at the location of the proposed crossing. The subsurface conditions illustrated in **Figure 2.1** are largely based on (1) three borings and a geophysical survey conducted by HLA in 1984, (2) a bluff reconnaissance by Shannon & Wilson (1971), (3) a geophysical survey by Dames & Moore (1970), (4) limited offshore explorations by the ADOT&PF (1970), and (5) additional explorations conducted by three investigators at the Port MacKenzie dock.

As shown in **Figure 2.1**, seven stratigraphic soil units are designated along the alignment. For the purpose of this preliminary study, data developed from the seven stratigraphic units were used to develop three idealized profiles that generally bound the range of (known) subsurface conditions expected (based on the limited data available) along the over-water portion of the bridge. The approximate sections of the alignment where each of the profiles can preliminarily be considered applicable are also shown in **Figure 2.1**. The stratigraphy, material properties, and geotechnical design parameters adopted for each of the idealized profiles are summarized in Tables 2-1 through 2-3. Two alternative models were considered along the eastern portion of the alignment: (1) Profile 3a with hard clay between 107 and 240 feet, and (2) Profile 3b with very dense sand and gravel between 107 and 240 feet penetration.

**Table 2-1. Geotechnical Design Parameters: Profile 1
(Based on Boring B-6 and Cross Section)**

[Note: Elevation = approximately -40 feet]

Unit	Description	Depth (feet)	Submerged Unit Weight, γ' (pcf)	Undrained Shear Strength, S_u (ksf)	Angle of Internal Friction, ϕ' (degrees)	Soil-Pile Friction Angle, δ (degrees)	Limiting Skin Friction, F_{max} (kips/ft ²)	Bearing Capacity Factor, N_q	Limiting Unit End Bearing, Q_{max} (kips/ft ²)
I	Loose to Medium Dense Sand	0 - 13	55	-	25	20	1.4	12	60
II	Very Dense Sandy Gravel	13 - 37	65	-	40	35	2.4	50	250
VI	Hard Silt	37 - 82	60	4.0	-	-	-	-	-
VII	Very Dense Sand and Gravel	82 - 300	65	-	40	35	2.4	50	250

**Table 2-2. Geotechnical Design Parameters: Profile 2
(Based on Boring B-4 and Cross Section)**

[Note: Elevation = approximately -65 feet]

Unit	Description	Depth (feet)	Submerged Unit Weight, γ' (pcf)	Undrained Shear Strength, S_u (ksf)	Angle of Internal Friction, ϕ' (degrees)	Soil-Pile Friction Angle, δ (degrees)	Limiting Skin Friction, F_{max} (kips/ft ²)	Bearing Capacity Factor, N_q	Limiting Unit End Bearing, Q_{max} (kips/ft ²)
I	Loose to Medium Dense Sand	0 - 26	55	-	25	20	1.4	12	60
IIIA	Medium Dense Silty Sand	26 - 70	60	-	25	20	1.4	12	60
IIIB	Dense Silty Sand	70 - 87	60	-	30	25	1.7	20	100
V	Dense to Very Dense Gravelly Silty Sand	87 - 137	65	-	35	30	2.0	40	200
VII	Very Dense Sand and Gravel	137 - 300	65	-	40	35	2.4	50	250

**Table 2-3. Geotechnical Design Parameters: Profile 3
(Based on Boring B-5 and Cross Section)**

[Note: Elevation = approximately -50 feet]

Unit	Description	Depth (feet)	Submerged Unit Weight, γ' (pcf)	Undrained Shear Strength, S_u (ksf)	Angle of Internal Friction, ϕ' (degrees)	Soil-Pile Friction Angle, δ (degrees)	Limiting Skin Friction, F_{max} (kips/ft ²)	Bearing Capacity Factor, N_q	Limiting Unit End Bearing, Q_{max} (kips/ft ²)
I	Loose to Medium Dense Sand	0 - 10	55	-	25	20	1.4	12	60
IV	Very Dense Silty Sandy Gravel	10 - 107	65	-	35	30	2.0	40	200
VI	Profile 3A Hard Silty Clay and Clayey Silt	107 - 240	60	4.0	-	-	-	-	-
	Profile 3B Very Dense Sand and Gravel	107 - 240	65	-	40	35	2.4	40	250
VII	Very Dense Sand and Gravel	240 - 300	65	-	40	35	2.4	50	250

2.4.2 Pile Size and Hammers Considered

The desired ultimate capacities of the axial piles are on the order of 15,000 to 18,000 kips (65 to 80 meganewtons [MN]). Preliminary calculations suggest that to obtain those capacities, piles on the order of 8 to 10 feet in diameter and more than 100 feet long could be required. In view of the relatively hard pile-driving conditions anticipated at the site, large hammers and thick-walled piles will be required. A worldwide hammer inventory indicated that currently several hammers with rated energies on the order of 1,700 kilojoules (kJ) are available, but relatively few hammers have larger energy ratings. To evaluate the influence of pile wall thickness, wall thicknesses of two inches and three inches were selected for the eight-foot-diameter piles. Although the pile will likely be designed with a variable wall thickness, a uniform wall thickness was considered sufficient for these conceptual evaluations.

In addition to evaluating a foundation that consists of relatively few, very large-diameter piles, consideration was also given to a foundation with a greater number of intermediate-sized piles. For the purpose of evaluating the smaller-diameter piles, analyses were also conducted for four-foot-diameter piles. Two wall thicknesses were considered, and the smallest hammers able to deliver the maximum energy that can be transferred to the pile tip for the chosen pile sections were selected.

The following table summarizes the pile sizes, pile sections, and hammers considered in these analyses:

Table 2-4. Pile Size and Hammers Considered

Pile Diameter (feet)	Pile Wall Thickness (inches)	Hydraulic Hammer - Rated Energy
8	2	1180 kip-ft (1600 kJ)
8	3	1180 kip-ft (1600 kJ)
10	3 1/8	1180 kip-ft (1600 kJ)
4	1	148 kip-ft (200 kJ)
4	1 1/2	369 kip-ft (500 kJ)

2.4.3 Methodology

The available subsurface data suggest that the site is primarily underlain by relatively dense and hard soils. The presence of significant thicknesses of dense sand and gravel suggests that pile lengths and, therefore, pile capacity will be limited by the penetration to which piles can reasonably be installed. To minimize the number of piles, consideration was first given to estimating the range of penetration to which piles could be driven. Subsequently, the ultimate pile capacity was calculated for piles driven to that elevation. The methodology adopted for these preliminary assessments is summarized as follows:

- 1 Axial pile capacity analyses were performed for three nominal pile sizes: four-, eight-, and ten-foot-diameter steel pipe piles using the three representative soil profiles.

- 2 The results of analyses of axial pile capacity were used to estimate upper and lower bound soil resistance to driving (SRD) profiles.
- 3 The SRD profiles were used together with published wave-equation analyses to estimate the maximum SRD that could be overcome for a range of pile-hammer combinations.
 - Maximum SRD values that could be overcome by the pile-hammer combinations were used to estimate a likely range of refusal penetrations based on the estimated upper and lower bound SRD profiles.
 - Ultimate axial pile capacities (tension and compression) were estimated for the likely range of refusal penetrations.

2.5 Conclusions

As shown in Tables 2-5 through 2-8, it is estimated that average pile penetrations on the order of 120 to 170 feet can be achieved for the large-diameter piles with the use of a large hydraulic pile-driving hammer. Case histories exist from the offshore experience in Cook Inlet (with somewhat similar soils conditions) for use of the following: (1) piles on the order of 34 to 84 inches in diameter, (2) piles driven to penetrations ranging from 60 to 125 feet, and (3) use of air-steam hammers with rated energies on the order of 870 kip-foot (1,200 kJ). Air steam hammers are typically less efficient than the hydraulic hammers considered in this preliminary evaluation. In some instances, pile cleanout was required to achieve design penetration.

**Table 2-5. Preliminary Pile Drivability and Axial Pile Capacity Evaluations:
Profile 1 (Boring B-6)**

[Note: Average Mudline = El. -40 feet]

Pile					
▪ Pile diameter, feet	4	4	8	8	10
▪ Wall Thickness, inches	1	1-1/2	2	3	3-1/8
Hammer					
▪ Rated Energy of Hydraulic Hammer, kJ	200	500	1600	1600	1600
▪ Allowable SRD, kips	3375	6750	18000	22500	27000
Pile Penetration Based on Estimated SRD					
▪ Maximum Achievable Penetration					
○ Lower Bound SRD Conditions, feet	95	155	130	210	130
○ Upper Bound SRD Conditions, feet	95	95	105	105	110
▪ Average Penetration, feet	95	125	118	158	125
Average Pile Length (assuming pile cut off at El. 0 feet), feet	135	165	158	198	165
Wall Area, ft²	1.03	1.52	4.10	6.09	8.07
Average Steel Volume, ft³	138	251	646	1202	1332
Ultimate Axial Pile Capacity Based on Maximum Pile Penetrations					
▪ Ultimate Tension Capacity					
○ In Lower Bound SRD Conditions					
– kips	2000	3500	5500	10500	7000
– MN	8.9	15.6	24.4	46.7	31.1
○ In Upper Bound SRD Conditions					
– kips	2000	2000	4000	4000	5500
– MN	8.9	8.9	17.8	17.8	24.4
○ In Average SRD Conditions					
– kips	2000	2750	5000	7500	6250
– MN	8.9	12.2	22.2	33.3	27.8
▪ Ultimate Compression Capacity					
○ In Lower Bound SRD Conditions					
– kips	5000	6500	18000	23000	26750
– MN	22.2	28.9	80.0	102.2	118.9
○ In Upper Bound SRD Conditions					
– kips	5000	5000	17000	17000	25500
– MN	22.2	22.2	75.6	75.6	113.3
○ In Average SRD Conditions					
– kips	5000	5750	17500	20000	26125
– MN	22.2	25.6	77.8	88.9	116.1
Ratios					
▪ "Average" Tension Capacity/Steel Volume, kips/ft ³	14	11	8	6	5
▪ "Average" Compression Capacity/Steel Volume, kips/ft ³	36	23	27	17	20

**Table 2-6. Preliminary Pile Drivability and Axial Pile Capacity Evaluations:
Profile 2 (Boring B-4)**

[Note: Average Mudline = El. -65 feet]

Pile					
▪ Pile diameter, feet	4	4	8	8	10
▪ Wall Thickness, inches	1	1-1/2	2	3	3-1/8
Hammer					
▪ Rated Energy of Hydraulic Hammer, kJ	200	500	1600	1600	1600
▪ Allowable SRD, kips	3375	6750	18000	22500	27000
Pile Penetration Based on Estimated SRD					
▪ Maximum Achievable Penetration					
○ Lower Bound SRD Conditions, feet	120	215	230	270	235
○ Upper Bound SRD Conditions, feet	100	150	110	180	120
•	110	183	170	225	178
Average Pile Length (assuming pile cut off at El. 0 feet), feet	175	248	235	290	243
Wall Area, ft²	1.03	1.52	4.10	6.09	8.07
Average Steel Volume, ft³	179	377	964	1765	1957
Ultimate Axial Pile Capacity Based on Maximum Pile Penetrations					
▪ Ultimate Tension Capacity					
○ In Lower Bound SRD Conditions					
– kips	1500	4000	9000	11500	11750
– MN	6.7	17.8	40.0	51.1	52.2
○ In Upper Bound SRD Conditions					
– Kips	1000	2500	3000	6500	4000
– MN	4.4	11.1	13.3	28.9	17.8
○ In Average SRD Conditions					
– Kips	1125	3250	6000	9000	8000
– MN	5.0	14.4	26.7	40.0	35.6
▪ Ultimate Compression Capacity					
○ In Lower Bound SRD Conditions					
– Kips	4000	7500	21750	24000	31750
– MN	17.8	33.3	96.7	106.7	141.1
○ In Upper Bound SRD Conditions					
– Kips	3750	5000	13000	16500	20000
– MN	16.7	22.2	57.8	73.3	88.9
○ In Average SRD Conditions					
– Kips	3875	5750	16250	21750	23500
– MN	17.2	25.6	72.2	96.7	104.4
Ratios					
▪ "Average" Tension Capacity/Steel Volume, kips/ft ³	6	9	6	5	4
▪ "Average" Compression Capacity/Steel Volume, kips/ft ³	22	15	17	12	12

**Table 2-7. Preliminary Pile Drivability and Axial Pile Capacity Evaluations:
Profile 3A (Boring B-5)**

[Note: Average Mudline = El. -55 feet;
Italics Type = Potential for Shallow Refusal in Overlying Gravel Layer]

Pile					
▪ Pile diameter, feet	4	4	8	8	10
▪ Wall Thickness, inches	1	1-1/2	2	3	3-1/8
Hammer					
▪ Rated Energy of Hydraulic Hammer, kJ	200	500	1600	1600	1600
▪ Allowable SRD, kips	3375	6750	18000	22500	27000
Pile Penetration Based on Estimated SRD					
▪ Maximum Achievable Penetration					
○ Lower Bound SRD Conditions, feet	150	225	240	240	240
○ Upper Bound SRD Conditions, feet	125	185	205	240	240
▪ Average Penetration, feet	138	205	223	240	240
Average Pile Length (assuming pile cut off at El. 0 feet), feet	188	255	273	290	290
Wall Area, ft²	1.03	1.52	4.10	6.09	8.07
Average Steel Volume, ft³	192	388	1118	1765	2340
Ultimate Axial Pile Capacity Based on Maximum Pile Penetrations					
▪ Ultimate Tension Capacity					
○ In Lower Bound SRD Conditions					
– Kips	3500	6500	14500	14500	18000
– MN	15.6	28.9	64.4	64.4	80.0
○ In Upper Bound SRD Conditions					
– Kips	2750	4750	11500	14500	18000
– MN	12.2	21.1	51.1	64.4	80.0
○ In Average SRD Conditions					
– Kips	3000	5750	13000	14500	18000
– MN	13.3	25.6	57.8	64.4	80.0
▪ Ultimate Compression Capacity					
○ In Lower Bound SRD Conditions					
– Kips	3750	7000	27000	27000	38000
– MN	16.7	31.1	120.0	120.0	168.9
○ In Upper Bound SRD Conditions					
– Kips	3000	5250	13000	27000	38000
– MN	13.3	23.3	57.8	120.0	168.9
○ In Average SRD Conditions					
– Kips	3500	6000	14750	27000	38000
– MN	15.6	26.7	65.6	120.0	168.9
Ratios					
▪ “Average” Tension Capacity/Steel Volume, kips/ft ³	16	15	12	8	8
▪ “Average” Compression Capacity/Steel Volume, kips/ft ³	18	15	13	15	16

Table 2-8. Profile 3B (Boring B-5)*[Note: Average Mudline = El. -55 feet]*

Pile					
▪ Pile diameter, feet	4	4	8	8	10
▪ Wall Thickness, inches	1	1-1/2	2	3	3-1/8
Hammer					
▪ Rated Energy of Hydraulic Hammer, kJ	200	500	1600	1600	1600
▪ Allowable SRD, kips	3375	6750	18000	22500	27000
Pile Penetration Based on Estimated SRD					
▪ Maximum Achievable Penetration					
○ Lower Bound SRD Conditions, feet	100	120	140	210	150
○ Upper Bound SRD Conditions, feet	60	165	105	131	105
▪ Average Penetration, feet	80	143	123	171	128
Average Pile Length (assuming pile cut off at El. 0 feet), feet	130	193	173	221	178
Wall Area, ft²	1.03	1.52	4.10	6.09	8.07
Average Steel Volume, ft³	133	293	708	1342	1432
Ultimate Axial Pile Capacity Based on Maximum Pile Penetrations					
▪ Ultimate Tension Capacity					
○ In Lower Bound SRD Conditions					
– Kips	1500	2000	5500	10000	7500
– MN	6.7	8.9	24.4	44.4	33.3
○ In Upper Bound SRD Conditions					
– Kips	500	3500	2000	5000	2500
– MN	2.2	15.6	8.9	22.2	11.1
○ In Average SRD Conditions					
– Kips	1000	2750	4750	7500	5000
– MN	4.4	12.2	21.1	33.3	22.2
▪ Ultimate Compression Capacity					
○ In Lower Bound SRD Conditions					
– Kips	4000	5250	18500	22500	27750
– MN	17.8	23.3	82.2	100.0	123.3
○ In Upper Bound SRD Conditions					
– Kips	2500	6750	12500	18000	18500
– MN	11.1	30.0	55.6	80.0	82.2
○ In Average SRD Conditions					
– Kips	3250	6000	16500	20000	24750
– MN	14.4	26.7	73.3	88.9	110.0
Ratios					
▪ “Average” Tension Capacity/Steel Volume, kips/ft ³	8	9	7	6	3
▪ “Average” Compression Capacity/Steel Volume, kips/ft ³	24	20	23	15	17

Two models were considered for Profile 3. The results for Profile 3a are based on a substantial thickness of clay, and Profile 3b is considered to be all sand and gravel. Comparisons of the results suggest that similar or even higher pile capacities can be obtained for Profile 3a, because piles can and will need to be driven to deeper penetrations.

Because of the presence of a significant thickness of dense to very dense sand and gravel, a substantial fraction of pile capacity will be available in end bearing. Therefore, in contrast to structures where end bearing is only mobilized under extreme seismic loading (for example, Skyway for San Francisco-Oakland Bay Bridge East Span Safety Project), the large-diameter piles at this site may mobilize end-bearing resistance even under service loads. Because end-bearing resistance is typically mobilized under larger deflections, the design of the foundations should consider the potential for a somewhat softer pile response.

2.5.1 Design Development Considerations

From a geotechnical and foundation engineering perspective, the design development phase of the project should, at a minimum, include the following:

- **Preliminary Site Characterization.** Before preliminary design, a preliminary site characterization program should be conducted to provide comprehensive geotechnical data along the entire alignment to the depths required for pile design and site response analyses. The program, therefore, should include deep borings (with detailed sampling, laboratory testing, and in situ testing) integrated with a detailed geophysical exploration program.
- **Pile Installation Demonstration Project.** Before final design, a full-scale pile-installation demonstration project (PIDP) should be conducted to verify pile capacity and constructibility. The PIDP should be based on typical pile sizes developed during preliminary design, and a sufficient number of piles should be installed to bracket the range of soil conditions defined in the preliminary site characterization.
- **Final Site Characterization.** The final site characterization should be conducted to provide pier-specific characterization for the final bridge alignment. Borings should be drilled to depths in excess of the planned pile lengths.

Additional details and perspective relative to geotechnical site characterization and pile installation demonstration projects are provided in Section 2.7.

2.6 Construction Considerations

The preliminary evaluations reiterate the importance of adequate wall thickness for the installation of piles in hard driving conditions. For piles with thicker sections, more energy can be transferred to the pile tip, which generally will delay the occurrence of pile-driving refusal. In some instances (especially in Profile 3a), piles could encounter refusal in the shallow sandy gravel layers above the maximum penetration depths reported in Tables 2-5 through 2-8. In those instances, the maximum pile penetrations shown in Tables 2-5 through 2-8 are highlighted in bold italics. Piles with a smaller pile section have a greater potential for encountering refusal in those layers than piles with a larger sectional area.

As indicated in **Figure 2.1** and noted on some of the borings, there is a high potential for cobbles and boulders to be encountered during construction. If very large boulders are encountered, refusal to pile driving will occur, which would require pile cleanout and the need to core through the boulder. A suitably equipped pile-top drilling rig (likely

required for pile cleanout in order to place structural concrete) should be available at all times.

Oversized materials also have potential for damaging the pile during installation. In general, the use of a thicker wall pile and a driving shoe should reduce the potential for damage to the pile. The driving shoe should also have adequate inside clearance to reduce inside skin friction during driving.

Because of the potential for cobbles, boulders, variable geology, and hard driving conditions, piles should be monitored with pile-driving analyzers to reduce the potential for overstressing and damaging the piles. When pile stresses are being monitored, it may be possible to safely advance the pile even though relatively high blow counts are required.

The handling and driving of long, large-diameter piles, with large hammers, in areas of strong currents and large tidal variations will present significant challenges during construction. The uncertainties associated with working in such an environment should be taken into consideration during the preparation of cost estimates.

2.7 ABUTMENT AND HIGHWAY EMBANKMENT CONSIDERATIONS

This section provides preliminary foundation parameters for sizing and evaluating the approach roads and smaller tunnel and overpass structures to tie the proposed Knik Arm bridge into the existing road system. This discussion focuses on developing preliminary recommendations to aid in developing a rational construction cost estimate for the remaining on shore portions of the project.

2.7.1 Bridge Over Ship Creek

Similar to the A Street Bridge over Ship Creek, a new highway bridge will need to be an elevated structure with wide column spacings to span much of the Alaska Railroad main rail yard area, as well as the creek and buildings shown in **Figure 2.5**. This structure will likewise have to be supported on piles driven into the medium to very stiff clays or carried to the very dense bearing stratum situated roughly 160 feet (roughly Elevation -145 feet) below the valley bottom. As indicated above, this very dense stratum becomes shallower to the north and south and is about Elevation -80 and -60 feet respectively near each bank toe. Typical pile capacity and embedment depths for driven pipe piles for the clay stratum are contained in **Figure 2.8**. These curves were taken from Shannon & Wilson (2001b) and assume that the majority of the capacity (about 90 percent) is derived in skin friction. If the piles are thus carried about ten feet into the very dense stratum, much higher capacities on the order of 800 to 1500 kips or higher can probably be achieved; the capacity can be largely dependent on the pile diameter and allowable stresses in the pile selected. Pile fixity under lateral loading is also expected to develop in the 30 to 50 foot depth range.

DEPTH VS. ALLOWABLE PILE CAPACITIES OPEN END PILES

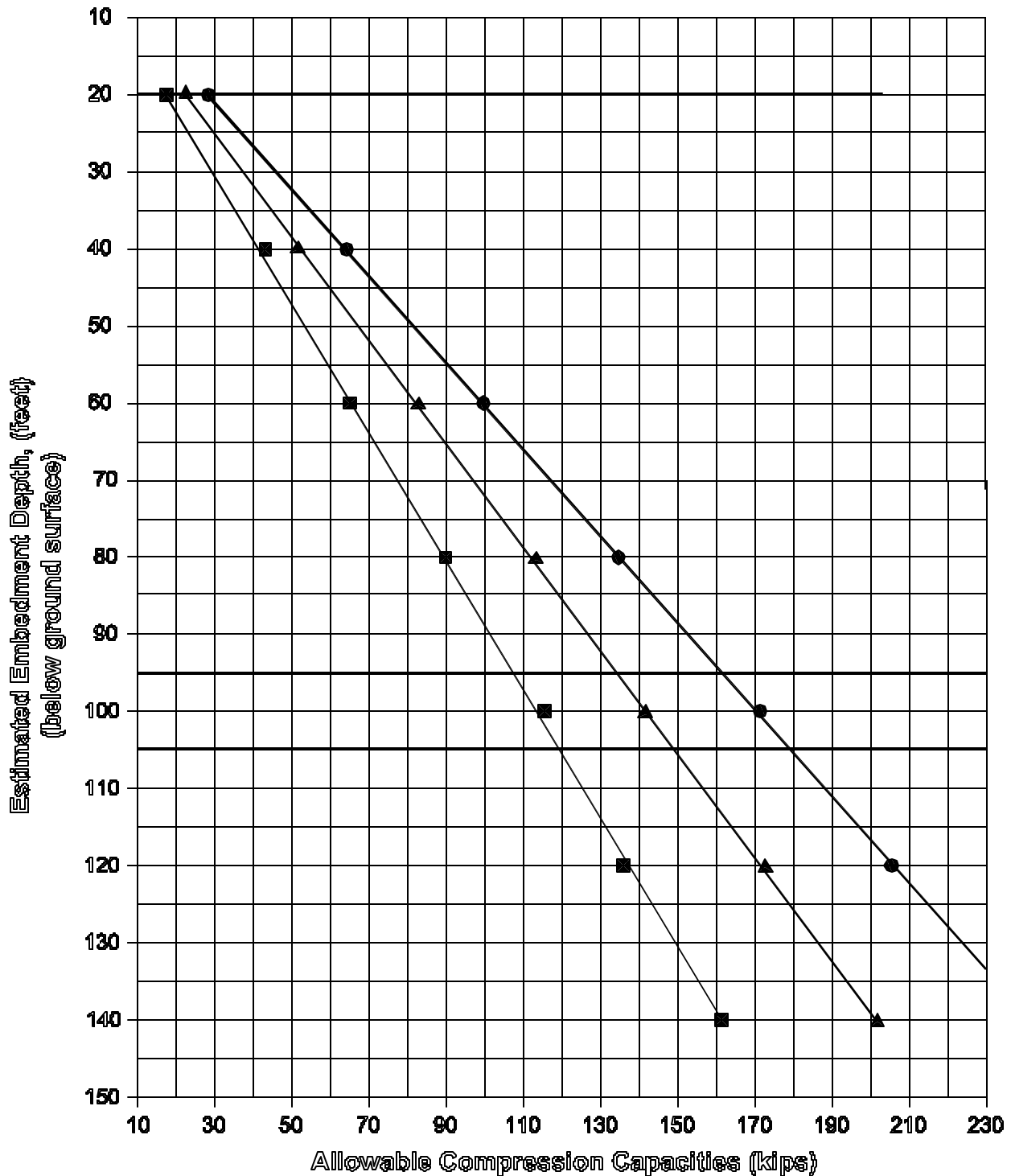

If piles are carried to very dense sand and gravel stratum, much higher capacities are possible

From Shannon & Wilson, 2001

LEGEND

- 24 inch diameter pipe pile
- ▲ 30 inch diameter pipe pile
- 36 inch diameter pipe pile

Based on allowable skin friction of 375 psf
Factor of Safety of 2 on ultimate capacities.
Pipe piles are standard steel Fy = 36ksi

Knik Arm Crossing Engineering Feasibility and Cost Estimate Update

SHIP CREEK OVERPASS PILE RECOMMENDATIONS

October 2002

32-1-01536

SHANNON & WILSON, INC.
Geotechnical & Environmental Consultants

Fig. 2.8

2.7.2 Government Hill Landslide

About 400 feet south and east of the south tunnel portal, the highway passes across an 800-foot-wide toe section of the slope that failed during the 1964 Alaska Earthquake. This landslide is shown in **Figure 2.5**. During the earthquake, this over-steepened slope dropped as much as 20 feet and moved laterally about 50 feet. Development and accommodation of highway lanes will require slope flattening, terracing, and possibly a toe buttress. Stability studies of the bluff area to the east of this slide have suggested that the overall average cut slopes should be kept to about 2 H:1 V or flatter. Deep permanent cuts in the toe or large fills at the higher elevations should both be avoided if dynamic stability conditions are to be maintained.

2.7.3 Cut-and Cover Tunnel through Government Hill

To accommodate four lanes of traffic, it is envisioned that the two lanes in each direction will be stacked, forcing the tunnel to pass mostly through the overlying clean granular soils and to a lesser extent the medium to stiff clays in the deeper parts of the hill (below Elevation +60 feet). As discussed previously, because of potential running ground conditions, the granular soils are more favorable to cut-and-cover construction than to conventional tunneling methods. To develop a typical tunnel section and estimate the cost of this 700-foot tunnel, it is assumed that the wide trench cut will contain vertical walls to the invert of the lower road section. Presumably, the walls will be retained by slurry wall, conventional steel soldier piles, and wood lagging or a similar bracing system with tied back anchors to carry the lateral earth pressures. For sizing this temporary support system, the following preliminary design criteria are recommended:

Assumptions:

1. Wall height will be 50 to 70 feet.
2. Perched water will drain (no excess hydrostatic pressures).

Preliminary criteria:

Lateral earth pressure:

rectangular pressure diagram with pressure of $25H$ (pounds per square foot [psf])
where H = wall height (ft)

Soldier pile:

allowable tip bearing = 3,000 psf in stiff clay below Elevation -20 feet
allowable skin friction = 450 psf
ultimate passive earth pressure to check for toe kickout = $65 H^2 + 3,000 H$ in pounds

Tieback anchors

no line at toe for $H/2$ and then inclined at 60 degrees
with horizontal to surface
anchors inclined 10 to 20 degrees with horizontal
allowable skin friction for anchors behind no load zone = 1,500 psf in medium-dense sands, and 500 psf in medium to stiff clays (higher with staged pressure grouting)

Clay strengths vary considerably with depth at this site and are soft or medium stiff in some depth zones. Therefore, the above criteria will need to be modified during final design to reflect actual conditions, based on results of additional geotechnical studies.

The finished tunnel structure will need to accommodate the same above-earth pressures, traffic loads, and soil weights applied on the tunnel crown. For estimating crown loads, the unit weight of soil should be taken as 140 pounds per cubic foot (pcf). The finished structure should also contain subdrains to reduce future hydrostatic pressures or be designed to resist these water loads. The perched water level should be taken as Elevation + 65 feet or about 5 feet above the sand clay interface.

2.7.4 Port of Anchorage

In developing cargo storage pavements over the POA property, the land to most of the property edge is paved and generally contains about 3.5 to 4.5 feet of free-draining granular fill materials. These areas relative to the proposed alignment are shown in **Figure 2.9**. It is assumed that there will be a 400-foot right-of-way between the POA property and the toe of the steep slope to accommodate this highway and railroad line. Where the land is undeveloped, the ground is wet and contains interbedded or intermixed soft or loose silts, clays, and sands (slope colluviums and poor surface runoff) at shallow depths underlain by clays. These poor soils will need to be excavated and replaced with nonfrost susceptible fill as a future subgrade and pavement section. To accommodate these conditions, the structural section will need to be several feet greater than the 42-inch pavement section.

Because land is at a premium at the POA, setting this highway or rail line into the toe may be requested during design of the highway in this area. In considering this placement, it must be recognized that much of the slope face contains landslide debris and design and construction of a retaining wall will add to the cost of construction through this area. Also, because the slopes are very high in this region and have failed in earthquakes and from continuing water erosion, permanent toe cutting should be minimized to the extent possible.

2.7.5 Shoreline Embankment

From the POA area to the east bridge approach, the bluff slopes are steep and locally slumping and are subject to periodic failures from toe undercutting, bank face erosion, and occasional strong earthquakes. Therefore, the highway will have to be situated on the toe, which in this case will require covering the mudflats with embankment fill. This will also help buttress the old military landfill which has been reported to exist along the bluff in this area. For design, the minimum finished elevation of the road will have to be about Elevation +23 feet or higher, or at least 6 feet above the highest observed tide level. This elevation provides for a design wave of five feet, which was the wave used for design of many of the POA paved areas.

For embankment design and consistent with other fills on the mudflats, the fill supporting a pavement or rail section should be carried to and buttress the toe of the existing natural



PORT OF ANCHORAGE

TOE OF BLUFF SECTION

SHORELINE EMBANKMENT BUTTRESS

275+00 280+00 285+00 290+00 295+00 300+00 305+00 310+00 315+00 320+00 325+00 330+00 335+00

EAFB



STATE OF ALASKA
DEPARTMENT OF TRANSPORTATION
AND
PUBLIC FACILITIES
KNIK ARM CROSSING
ENGINEERING FEASIBILITY AND
COST ESTIMATE UPDATE

400 0 200 400

FIGURE 2.9

slopes, and should have maximum shoreline embankment slopes of 2H on 1V. All fill slopes within, above, and below the intertidal zone, as indicated below, should contain riprap. At the toe of the fills at the POA, a below-grade gravel toe buttress on the order of 15 feet deep is keyed into the soft silts often present on the mudflats to contain fill and maintain stability of the embankment slope under earthquake loading conditions. Recent studies on the mudflats north of the POA, however, have encountered stiffer shallow soils where a buttress in this local area will not be needed (Shannon & Wilson, 1997). For estimating purposes, it is suggested that allowance for a toe buttress be included along about 30 percent of the shoreline between the north edge of the POA and the east approach. Consistent with the buttress designed in a WWC report on the POA (1983), this buttress, shown in **Figure 2.10**, should be assumed to be 40 feet wide along the toe, embedded about 15 feet below the mudflats, and contain 2H on 1V slopes on the downslope sides of the below grade buttress. The 2H on 1V slopes form the outside of the embankment and are covered with riprap.

The embankment section supporting the shoreline roadway and rail line should consist of granular fill that can be placed and compacted to support the pavement section. Generally a Select Material Type A, B or C as described in Paragraphs 1 through 3 of Section 703-2.07 of the *ADOT&PF Standard Specification for Highway Construction* would meet this requirement. Generally, for compaction and drainage considerations, the Type A material should be used in the intertidal or wet construction areas of the embankment.

Consistent with most of the banks along Knik Arm, spring seepage occurs at various elevations on the slope. This water is generally perched on clay layers, resulting in subsurface seepage below the elevation that would be filled with embankment materials, as well as direct downslope runoff above the roadway fill. Similar to the POA area, both surface ditching and subdrains are needed to collect and carry this water by cross culverts through these embankment fills. Similar drainage systems should be planned for the road and rail segment north of the POA. The subdrain east of the POA and along the toe of this bank consists of a ten-inch perforated pipe buried about ten feet below the ground surface to prevent seasonal freeze ups of the pipe (USKH, 1990).

2.7.6 Abutment Bluffs

On the east approach, the bridge will transition to a fill embankment along the toe of similar, but smaller, bluff heights. To avoid deep fills in water and large blankets of riprap to accommodate the 40-foot tides, it is recommended that seaward filling of the mudflats be limited to water depths of 30 feet or less. Therefore, the piers and bridge structure should be bent around to closely merge with the embankment paralleling the shoreline. At the abutment edge, the bridge loads could be carried on piles with a riprap slope for erosion protection or a cofferdam face of vertical sheet pile.

As the bridge grade ascends to the high west side bluffs from the last bridge pier, bank seepage, slope erosion conditions, and toe erosion in the west abutment region will need to be stabilized, as discussed above. The severe gullying and minor sloughing indicate that surface runoff and subsurface seepage will combine to create maintenance problems.

Note 1: The minimum depth of the buttress below existing ground is 13 ft

Note 2: Field Verification of the actual bottom elevation during construction is strongly recommended

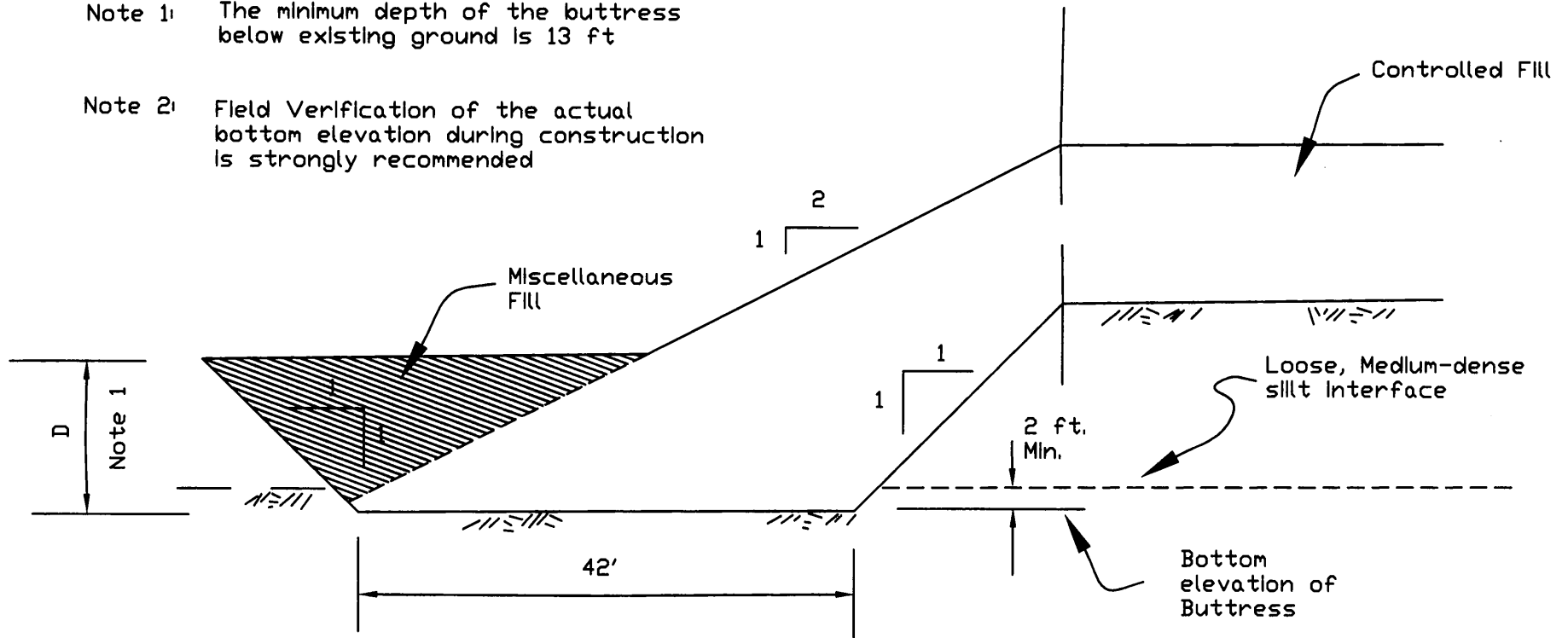

KNIK ARM CROSSING ENGINEERING FEASIBILITY
AND COST ESTIMATE UPDATE

SUGGESTED BUTTRESS CONFIGURATION

October 2002

32-1-01536



SHANNON & WILSON, INC.
Geotechnical & Environmental Consultants

FIG. 2.10

From Woodward Clyde Consultants, 1983

Design of the slope modifications is dependent on the elevation grades of the highway relative to the bluff. For a receding toe and slope, at an estimated average rate of about 1/2 foot per year (Shannon & Wilson, 1971), slope flattening and drainage control of the bluff should be planned with riprap protection in the general intertidal zone. A typical detail for this area was taken from the Shannon & Wilson 1971 geologic report, upgraded, and presented as **Figure 2.11**. The riprap should extend several hundred feet north and south of the bridge and from the maximum high water line (about Elevation +17 feet) to at least 10 feet below the low water line. The shore protection in **Figure 2.11** is needed to resist severe ice action in the winter as well as waves and tidal currents. Ice buildup on the order of seven feet has been reported at the Port MacKenzie Dock to the south. Vertical finger drains (gravel-filled shallow ditches) can also be used to carry cross drains in Detail A in **Figure 2.11** down the slope to the mudflats.

2.7.7 Pavement Section

Design of the pavement section along all highway segments must consider the structural support capabilities of the subgrade soils and their frost behavior. Generally, with the possible exception of some of the north approach highway on the Mat-Su Borough side of Knik Arm and a small segment of highway on the bluff between 2nd and 3rd avenues, the subgrade soils are largely frost susceptible. Therefore, frost will control the design thickness of the section and should largely consist of a full 42-inch pavement section with added drainage control to direct downslope surface and subsurface water away from the pavement section. It is recommended for planning purposes that the pavement section, in descending order, consist of 3 or 4 inches of asphalt, 6 inches of base, and 32 or 33 inches of subbase. Generally, the base course should consist of D-1 material, as specified in Section 703-2.03, Table 703-2, of the ADOT&PF *Standard Specification for Highway Construction*. For the subbase, a Selected Material Type A, as described in Paragraph 1 of Section 703-2.07 of the above specification, is recommended.

For the railroad track and ties, the track section should be constructed on a firm natural cut or embankment fill subgrade and topped with a minimum 12 inches of crushed sub-ballast and 12 inches of crushed ballast that meet railroad standard specifications. The subgrade surface should also be crowned to direct surface water away from the track section.

For the north access road to the west bridge approach and along the bluffs south of 2nd Avenue, better quality granular soils are generally present below the surface organics and silt layers, as indicated above. On the west side of Knik Arm, the local peats will be removed and the pavement section will be constructed on cuts or fill embankments of varying heights or depths as necessary for proper vertical and horizontal alignment. The pavement section will also be elevated as necessary to maintain positive surface drainage. Because the road grade is not yet established, a reasonable assumption for cost estimating is to assume that a full 42-inch pavement section, as recommended above, will be needed in this area.

For the bluff south of Second Avenue, studies for the Ingra Street extension (Shannon & Wilson, 1994) recommended that silty soils or suitable fills with excess fines or organics

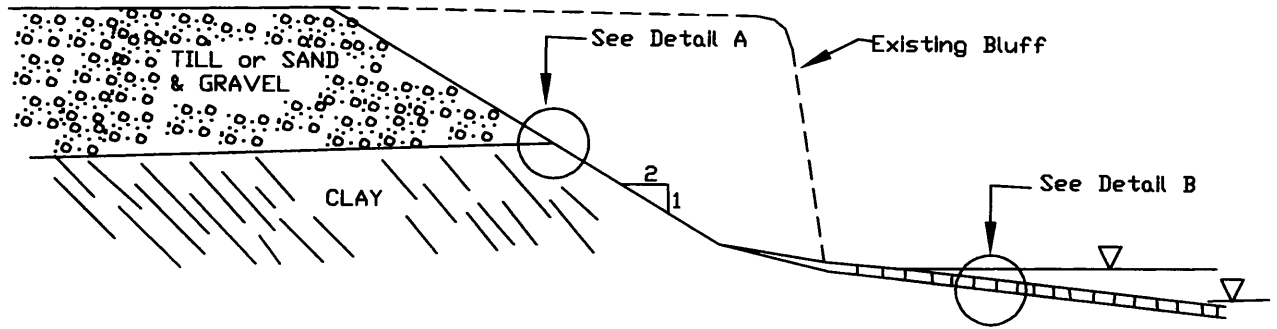

TYPICAL BLUFF SECTION

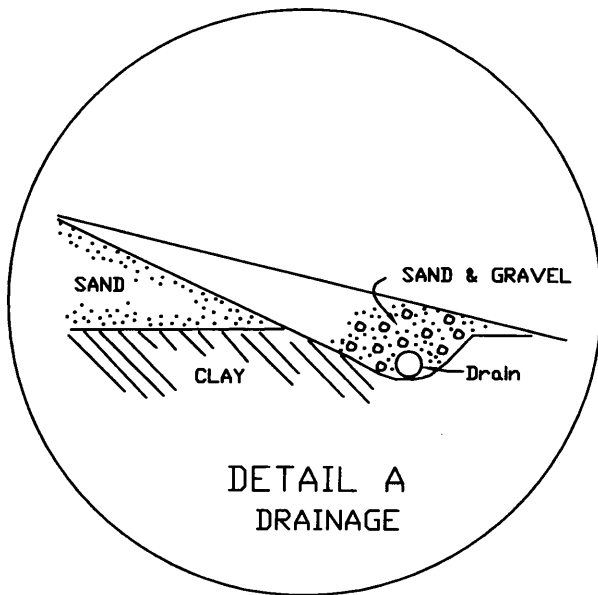
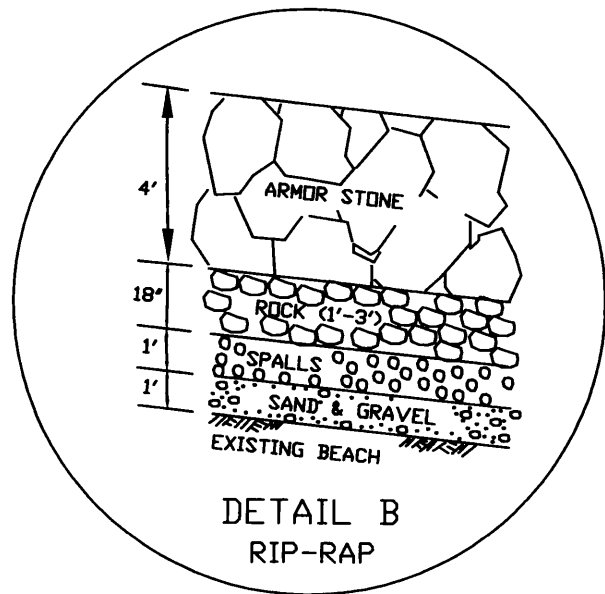

NOT TO SCALE

KNIK ARM CROSSING ENGINEERING FEASIBILITY
AND COST ESTIMATE UPDATE

EAST SIDE ABUTMENT TREATMENT

October 2002

32-1-01536



SHANNON & WILSON, INC.
Geotechnical & Environmental Consultants

FIG. 2.11

From Shannon & Wilson, 1971 (Modified)

be removed and the site brought to grade with the above-described 42-inch section. Assuming the soils at the subgrade consist of mostly nonfrost susceptible soils, the thickness of sub-base could be reduced if the finished street grade is less than 42 inches above the subgrade level.

2.8 CLOSURE

2.8.1 Use of Design Information

The design information provided in this study is extremely preliminary in nature and should not be used for purposes beyond those stated in this study. Although information contained in this study may be of some use for other purposes, this study may not contain information sufficient for other parties or uses.

2.8.2 Potential Variation in Subsurface Conditions

It is important to note that very little information is available at this time to define either the stratigraphy or the material properties for the over-water section of the bridge. Consequently, the bridge design and cost estimates should consider a high potential for significant variations from the idealized profiles and preliminary estimates obtained in these analyses. The available geotechnical data extend to limited depths and, therefore, do not “ground-truth” the geophysical data below Elevation -100 to Elevation -150 feet. Additionally, limited samples, laboratory data, and in situ data are available to estimate the material properties. Along the eastern half of the over-water alignment (the area associated with Profile 3), the HLA report (1984) suggests that even the geophysical data may be tenuous. Additionally, glacial soils in general are extremely variable. Consequently, there is a high potential for variations in soil conditions at the site and, therefore, variations in pile design data beyond the values presented in this study.

3.0 STRUCTURE TYPE UPDATE

3.1 Summary

This chapter presents feasible structural alternatives for a crossing Knik Arm along the Hybrid Alignment. These alternatives include prestressed, segmental concrete box girder bridges with spans between 400 and 600 feet. Options are presented for *road only* structures and for structures able to carry *both vehicular traffic and heavy rail*. The general characteristics of these structures are described.

The environmental conditions that will affect the design of the structure are discussed. They include deep water, cold weather, high seismicity, ice loads, and a large tidal range. The feasibility of design for these conditions and the design strategies to best accommodate them is also discussed.

This chapter also includes a general discussion of the cost of major water crossings. Comparable structures that may provide useful lessons for the design of the Knik Arm Crossing are presented.

3.2 Analysis

3.2.1 Hybrid Alignment

Alternative structure types were developed for the Hybrid Alignment shown in **Figure 3.1**. This crossing of Knik Arm is 13,500 feet in length between abutments. The radius of curvature of the structure is 2,050 feet near the east abutment—the minimum allowed for heavy rail—and straight over the remainder of the crossing. Construction of segmental concrete box girder bridges of the types considered in this study is quite feasible for this degree of curvature.

The profile elevation at the east abutment is 55 feet above mean sea level. Assuming a structural depth of 24 feet, this profile elevation is the minimum elevation that will accommodate a tidal range of 18 feet above mean sea level and a maximum wave height of 15 feet—10 feet of which is above still water. An abutment elevation of 60 feet above mean sea level would be preferable to obtain a clearance of eight feet between the soffit of the structure and the crests of the waves. The profile elevation at the west abutment is 130 feet above mean sea level. The average grade of the structure is 0.56 percent, which is a feasible grade for trains.

3.2.2 Superstructure

The choice of superstructure type is suggested by the following factors:

- Navigation must be provided for barge traffic only.
- Water depths are moderate, from 50 to 100 feet.

Segmental concrete box girder bridges with spans on the order of 400 to 700 feet are suitable for these conditions. It is possible that somewhat longer cable-stayed spans



Figure 3.1

Hybrid Alignment □
Knik Arm Crossing

would be economical in the deeper water near the north side of the crossing (see **Figure 3.2**).

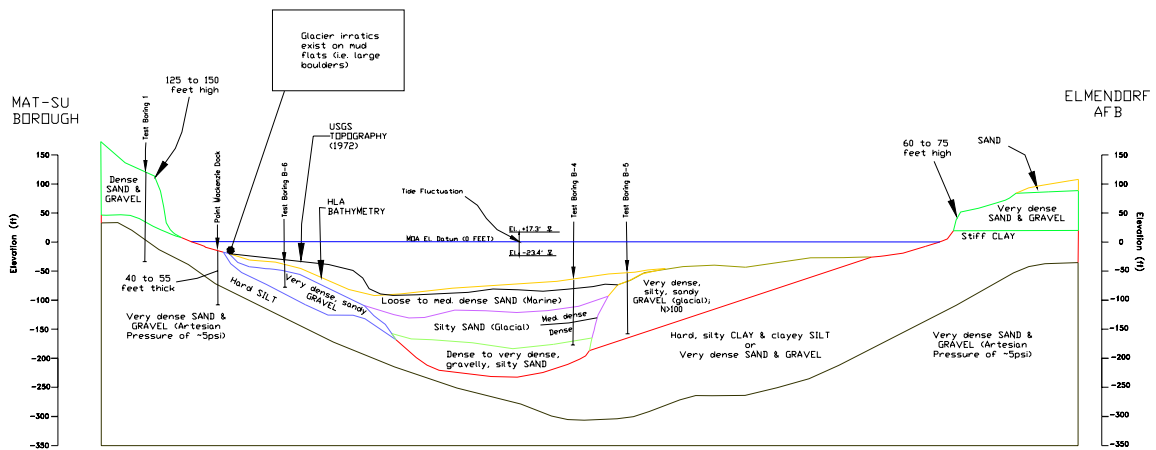

Figure 3.2. Water Depth

Another possibility is that the box girder spans could be extended into an extradosed structure (see **Figure 3.3**). These options have not been studied in any detail.

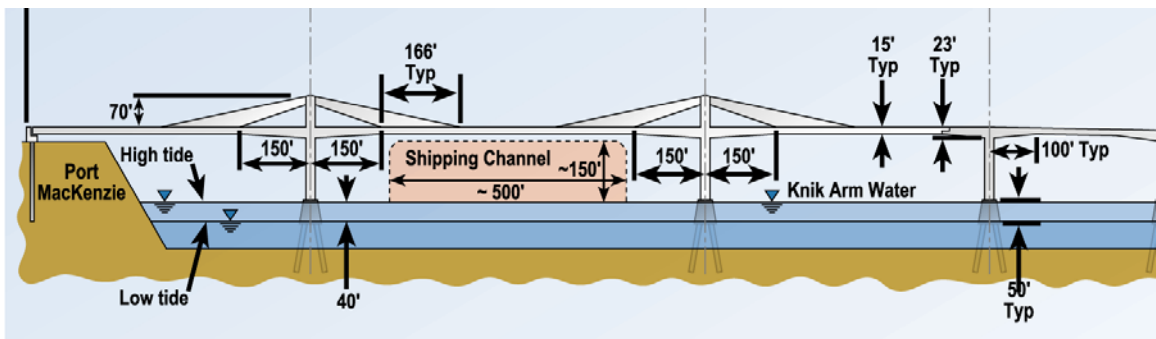

Figure 3.3. Extradosed Structure

In a previous study (FHWA and ADOT&PF, 1983a), a suspension bridge with a main span of 4,500 feet was recommended for the Downtown II alignment across Knik Arm. That alignment is fairly close to the Hybrid Alignment identified in this study. The large span was to accommodate water nearly 200 feet deep. Although a suspension bridge is not needed on the shallower Hybrid Alignment, the importance of water depth cannot be overemphasized. The relative economy of a box girder bridge decreases with increasing water depth. If the water is very deep, a box girder bridge may no longer be the most economical solution.

3.2.2.1 Material

Steel and concrete box girder bridges are both feasible alternatives for a crossing of Knik Arm. Given the high seismicity of the area, a steel box girder might appear to be advantageous because it might weigh only half as much as a similar concrete superstructure. This advantage is minimal, however, for a large, long-period structure in which the ductility demands are insensitive to mass. Steel alternatives were found to be about ten percent more expensive than concrete options for the new Benicia-Martinez and San Francisco-Oakland Bay bridges across San Francisco Bay—another seismically active area. For these bridges, the higher material cost of the steel outweighed the savings in foundations realized because of the lighter superstructure.

Also, a steel structure will require more maintenance than a similar concrete bridge, particularly in a marine environment. Another significant disadvantage of steel as a material is that it cannot be fabricated locally in the large, complex box sections required. The superstructure would probably have to be fabricated in the Pacific Northwest and barged to the site. Concrete could be produced locally, however, using local materials.

For these reasons, the bridge concepts presented in this study are concrete structures. Construction in steel should be reconsidered at a later date, when both concrete and steel options can be evaluated in greater detail. It is unlikely that a steel structure would cost significantly less than a concrete bridge.

3.2.2.2 Railroad Options

Two box girder cross sections able to carry heavy rail are presented in this section. The first concept assumes that the track can be placed inside the box girder. This solution has been used for several electrified railways in Europe. It is a technically feasible solution for diesel locomotives, although the matter of ventilation must be considered. The second concept assumes placement of the track on the top flange of the box girder, between the traffic lanes.

Track Inside the Box Girder

Considering the options in order of increasing span length, the option with the track inside the box girder is shown in **Figure 3.4**. As shown in **Figure 3.5** the cross section provides a clear opening 14 feet wide and 19.5 feet high—which was accepted by the Alaska Railroad. This cross section will accommodate heavy diesel locomotives, plus track and any necessary appurtenant equipment. There are two options for ventilation of the cross section. The first option is passive ventilation through openings in the webs near mid-span of the girder—the location of minimum shear. This option might be satisfactory if the volume of rail traffic is low. The second option is forced ventilation by fans placed along the sides of the cross section. Except for the occasional hinge between structural units (every 1,500 feet or so), this space available for this option is otherwise empty space.

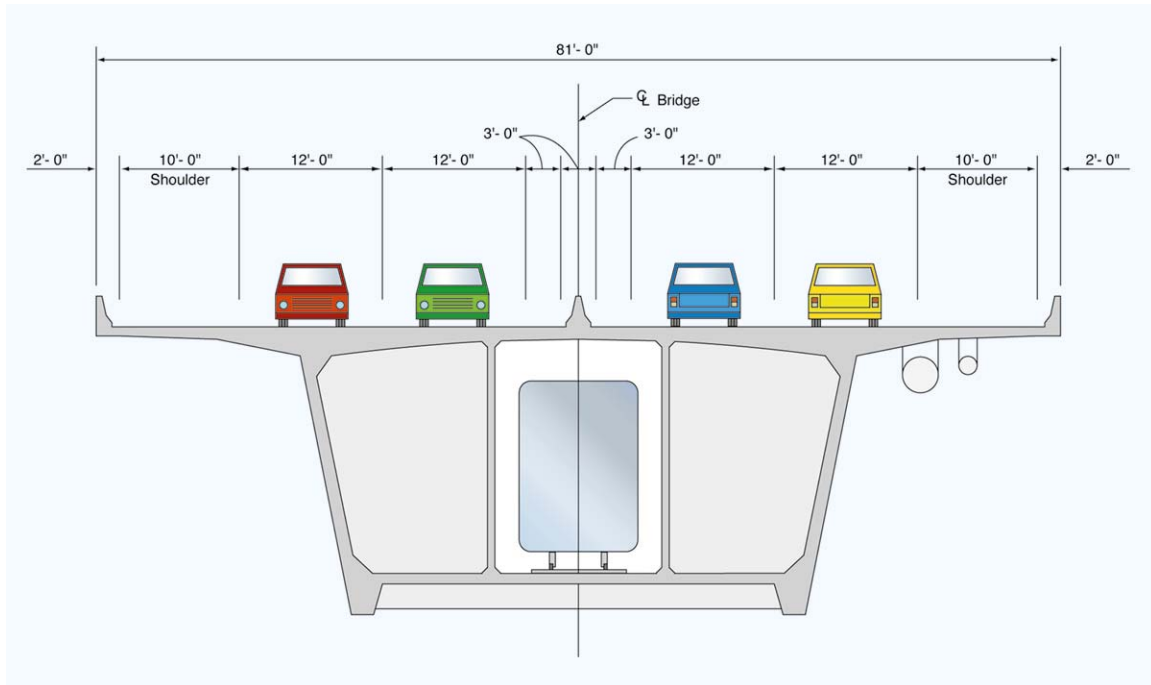

Figure 3.4. Railroad Inside Box Girder

Frequent transverse ribs would be needed to support the bottom slab between webs. These ribs would be post-tensioned to carry the heavy locomotive load.

This option requires a constant-depth box girder. This requirement limits the economically feasible span length, because a variable depth box girder is more efficient for spans over a few hundred feet. The cross section shown is 24 feet deep and can span an estimated 400 feet. The girder could be erected by using the heavy-lift method; the required lift would be about 3,800 tons. Construction methods are discussed below.

Track on Top of the Box Girder

The track may also be carried on the top flange of the box girder. **Figure 3.6** show a cross section intended to support the track along the center of the structure. This placement avoids any unsymmetrical loading of the structure by the heavy locomotive, although the problem of transitioning the track onto the structure must be solved. Similarly to the previous option, prestressed ribs are used to strengthen the top flange.

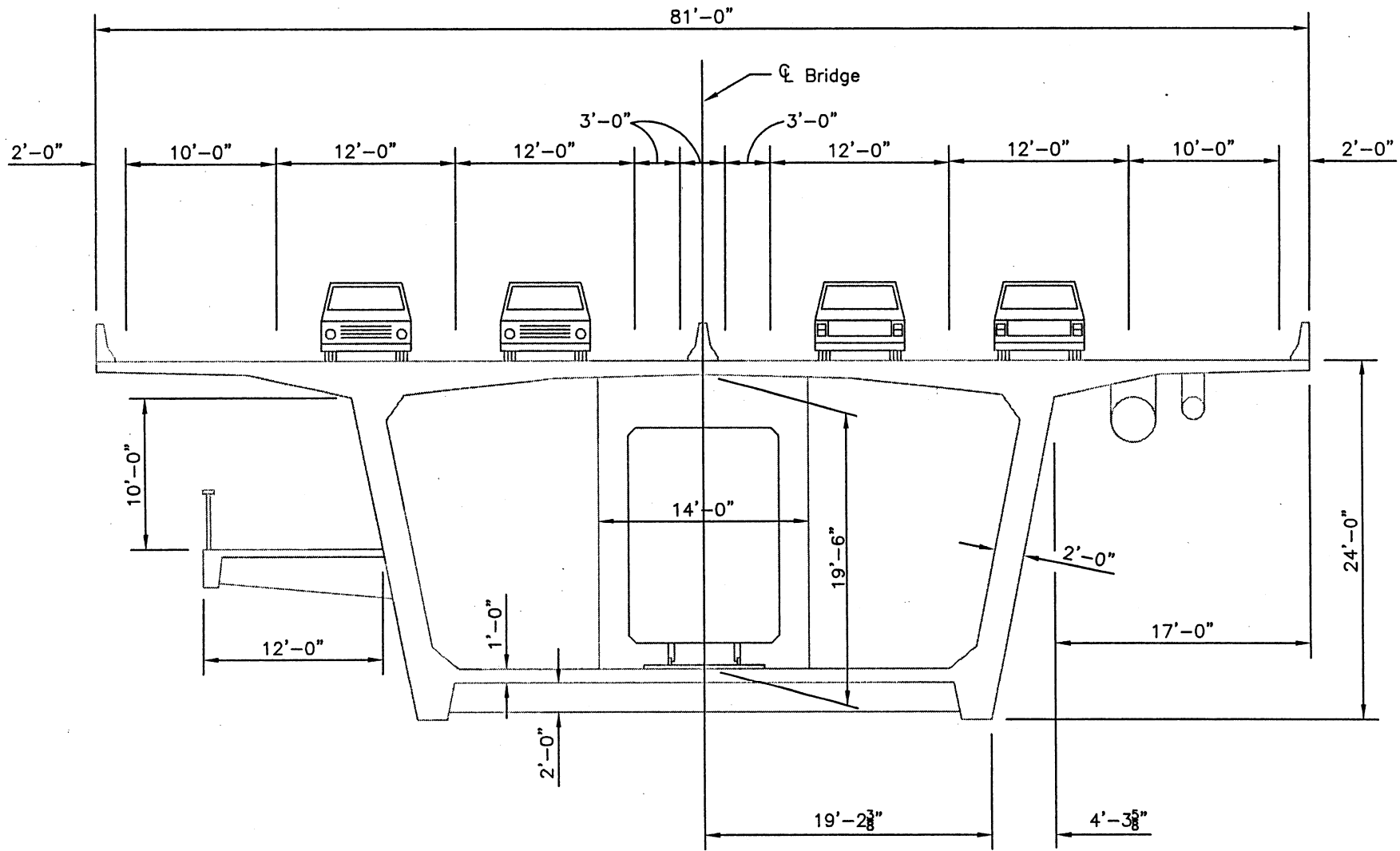

Figure 3.5

Railroad Inside Box Girder
Knik Arm Crossing

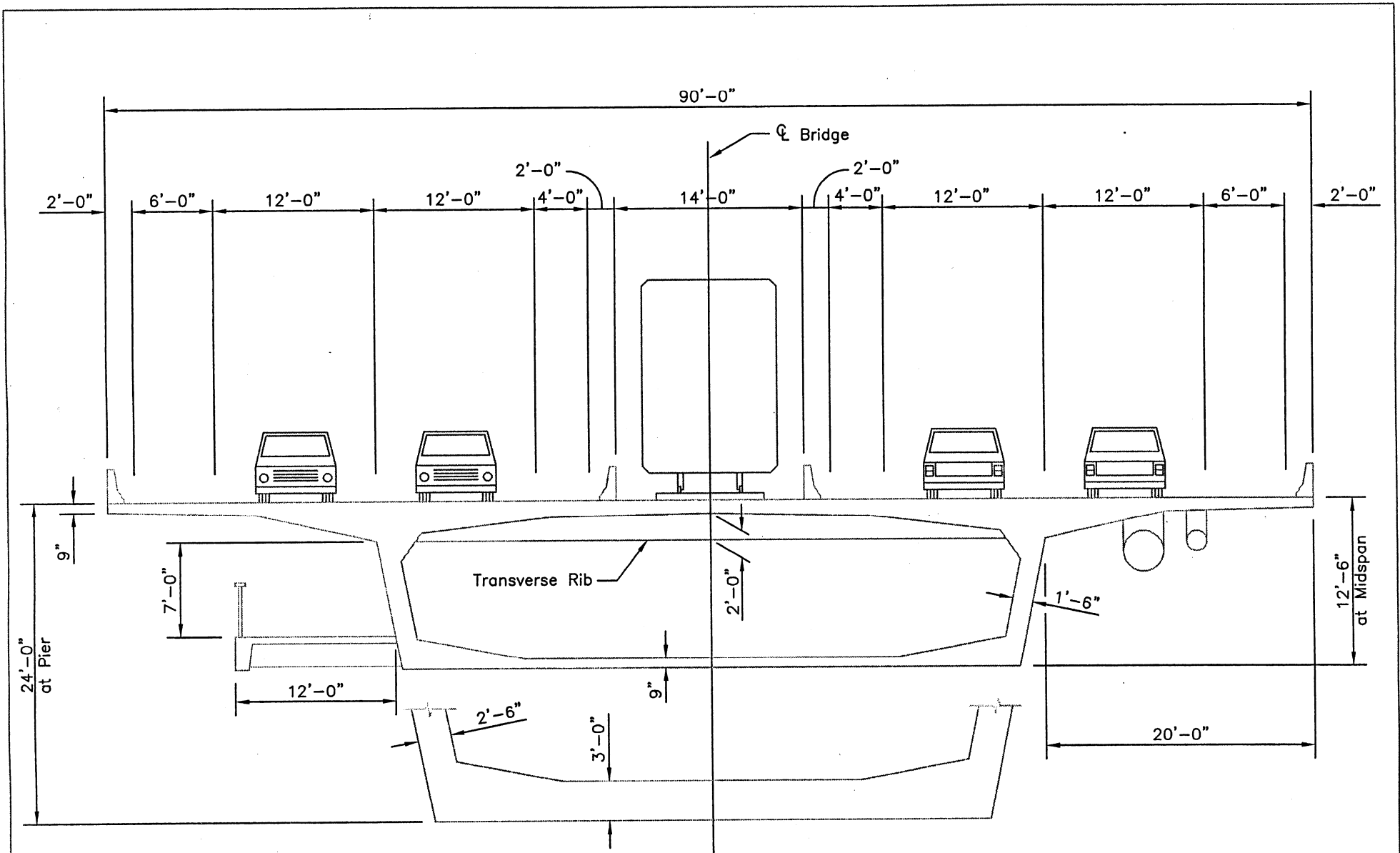

Figure 3.6

RR on Top Box Girder
Knik Arm Crossing

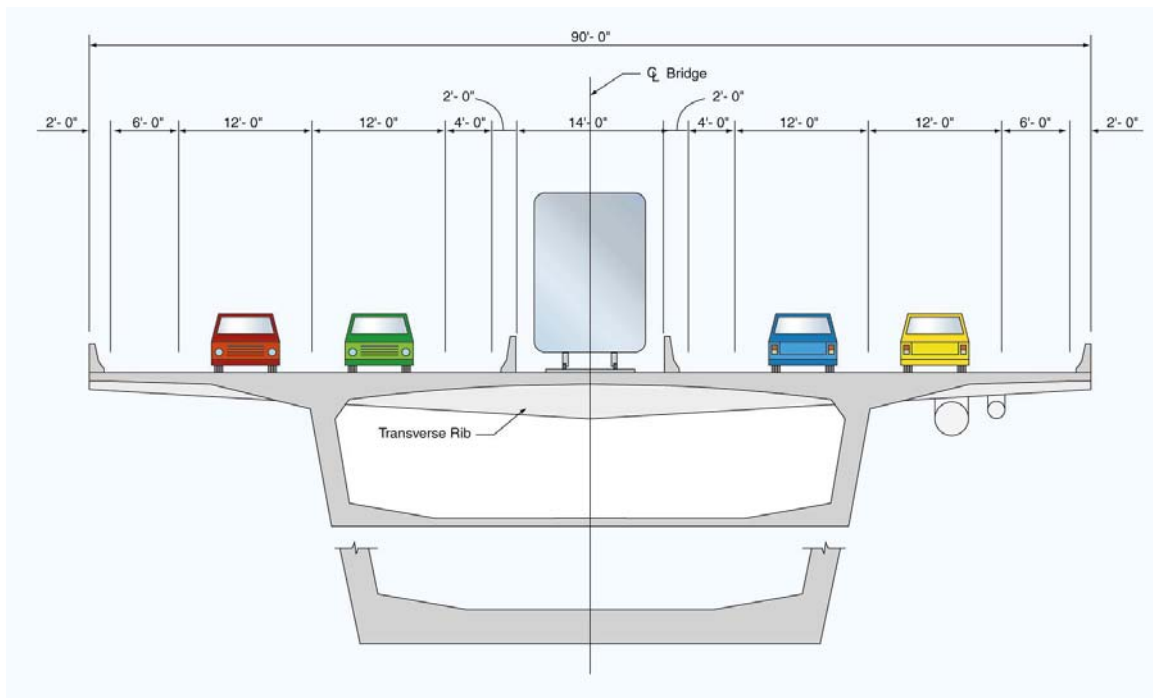

Figure 3.7. Railroad on Top of Box Girder

With the track on the top flange of the structure, it is possible to vary the depth of the box girder and increase the span. The cross section shown in **Figure 3.7** varies from 14 feet at mid-span to 24 feet at the pier and is intended for a span of 500 feet. The thickness of the bottom slab also increases near the pier in order to carry the increased bending moment at that location. Construction of this option would be by the balanced cantilever method (see below).

Separate Structure

A third option for carrying heavy rail is shown in **Figure 3.8**. In this option, the track is placed on a separate structure, to be built at some future date—or not at all if the need for a rail crossing doesn't develop. Only a common foundation need be built at the time of construction of the road bridge.

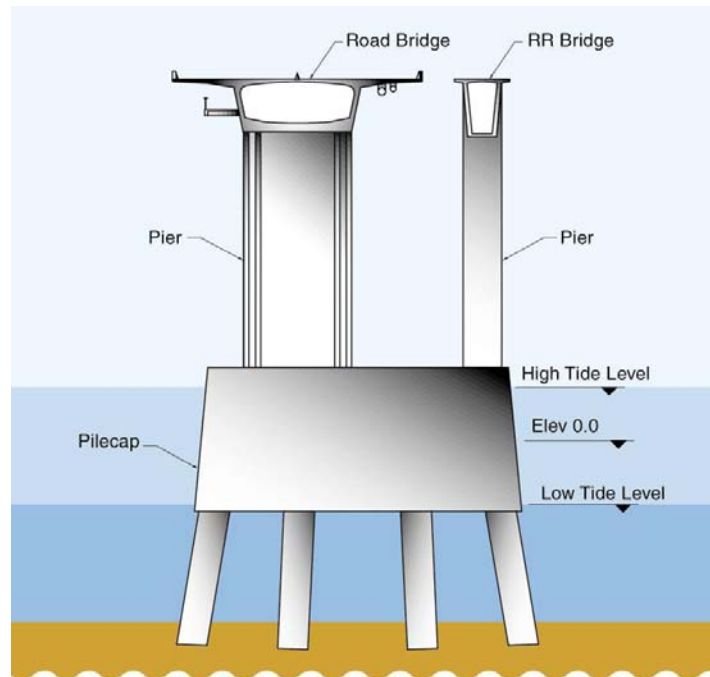

Figure 3.8. Separate Structure for Railroad

3.2.2.3 Road-Only Option

A box girder suitable for a road-only crossing is shown in **Figures 3.9** and **3.10**. The cross section is quite conventional. Transverse ribs may not be needed if the shoulder widths are not too large. It is assumed that the shoulders will meet the needs of cyclists desiring to cross the structure.

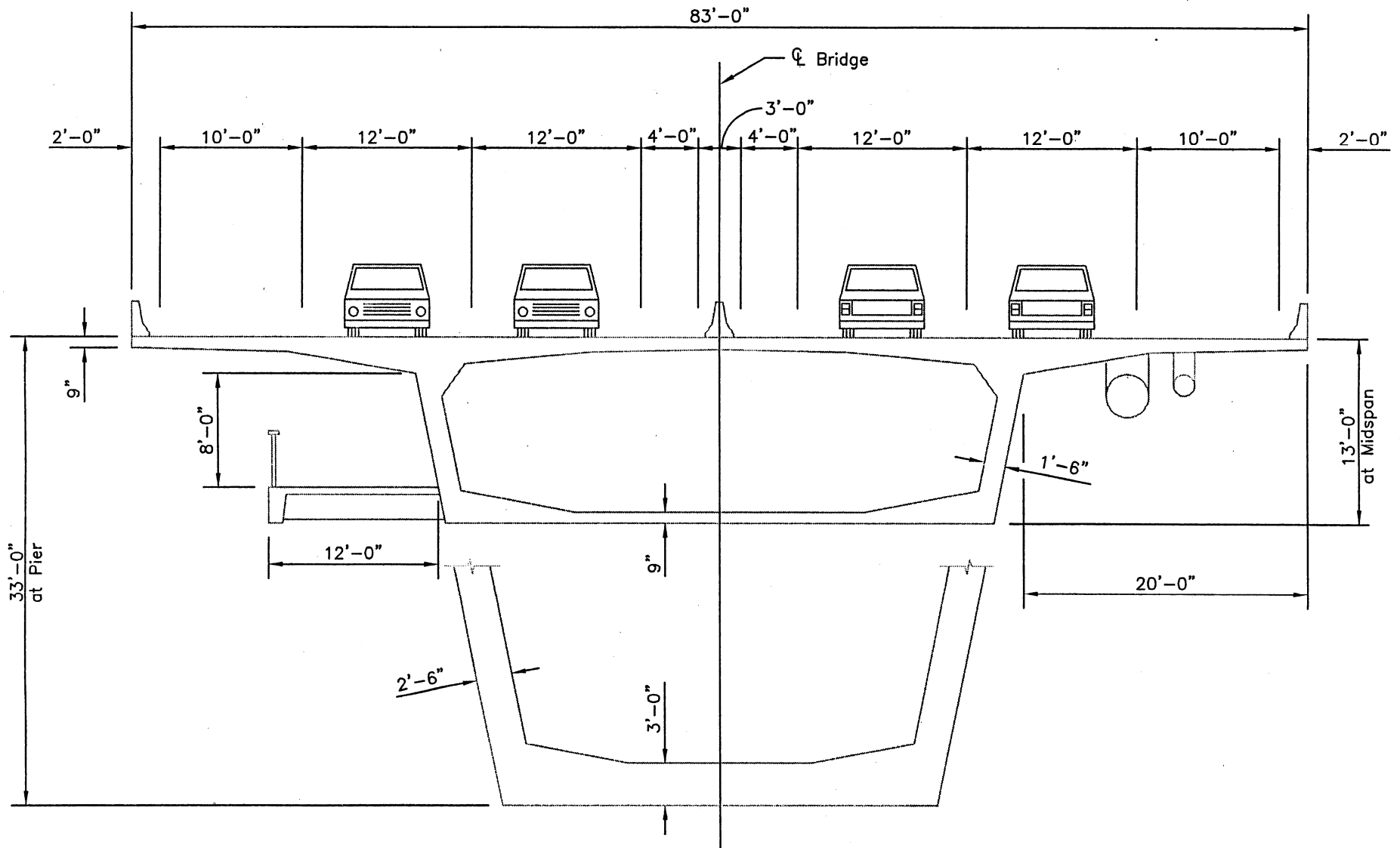

Figure 3.9

Road Only Box Girder
Knik Arm Crossing

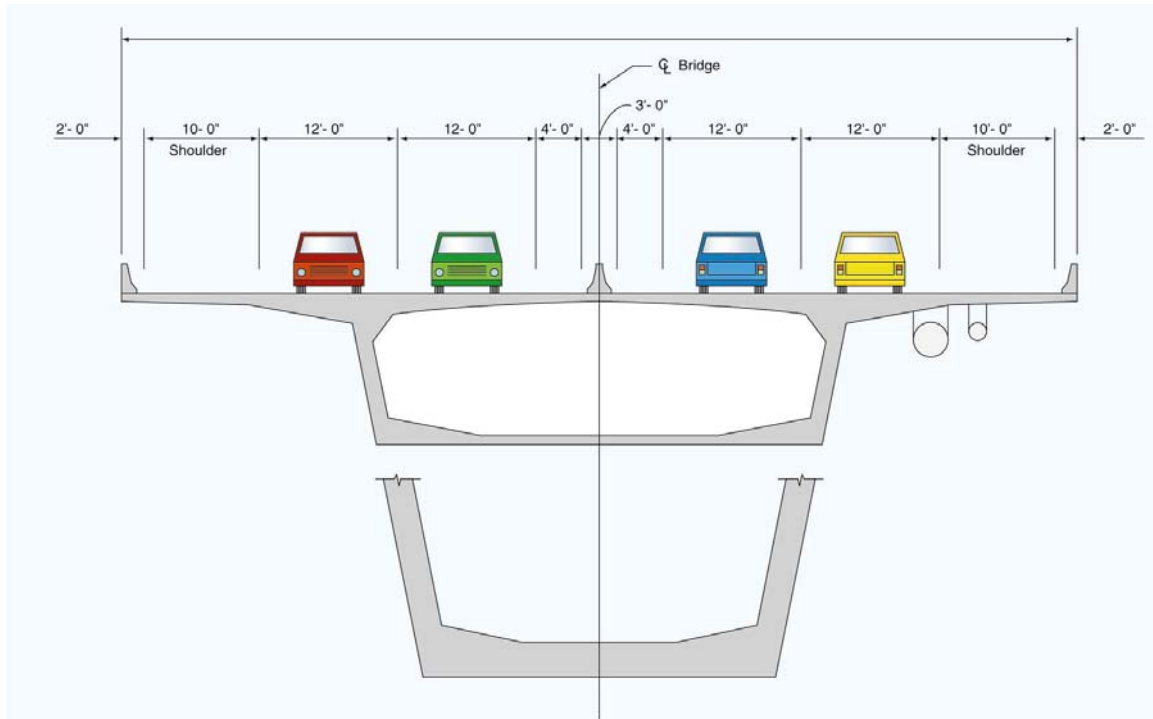

Figure 3.10. Road-Only Box Girder

The cross section shown in **Figure 3.10** varies from 13 feet at mid-span to 33 feet at the pier and is intended for a span of 600 feet. The thickness of the bottom slab is also variable. Construction of this option would be by the balanced cantilever method.

The optimum length of span depends on the relative costs of superstructure, piers, and foundations and is difficult to determine. The span lengths discussed in this study should be considered approximate because they are based on engineering judgment only and not on analysis. The optimum span length for a road-only option is likely to be between 500 and 700 feet. Similar structures now under construction in the San Francisco Bay Area—the Benicia-Martinez Bridge and the new San Francisco-Oakland Bay Bridge—have spans between 525 feet and 659 feet. San Francisco Bay is generally shallower than the Knik Arm, however. The Confederation Bridge connecting Prince Edward Island and New Brunswick, Canada, has spans of 820 feet. This bridge is eight miles long, however, and benefited from economies of scale that might not apply to a crossing of Knik Arm.

The optimum length of span depends on the depth of water. The depth varies significantly over the length of the Hybrid Alignment, and it may be different from the alignment selected for a Crossing project. Between the previously proposed Downtown and Elmendorf alignments, the maximum water depth varies from 145 feet to 75 feet. Depending on the final alignment of the crossing, it may be sensible to vary the span length with the depth of water, within the range of 500 to 700 feet.

3.2.2.4 Construction

Heavy-Lift

Heavy-lift construction may be a feasible option for erection of the constant-depth box girder spans intended to accommodate rail within the bridge cross section (see **Figure 3.2**). This method of construction is illustrated in **Figure 3.11**, which shows one segment of the approach that spans the Jamestown-Verrazanno Bridge in Rhode Island being lifted. The segment was lifted by using strand jacks similar in operation to post-tensioning jacks. The spools used to coil the strand during lifting are visible in the figure. The jacks and spools were placed on the pier tables immediately adjacent to the span. The Jamestown-Verrazanno bridge segments weighed 2,400 tons each and were among the heaviest ever lifted over water.



Figure 3.11. Heavy-Lift Construction (Jamestown-Verrazanno Bridge)

Construction of a 400-foot span for the Knik Arm Crossing would require a still larger lift. Most likely, it would not be economical to lift the entire cross section; just a portion of the cross section would be lifted. The part of the cross section most likely to be lifted is shown in **Figure 3.12**. This portion is the webs and bottom slab of the cross section shown in **Figure 3.5**. Even this lift would total 3,800 tons in normal weight concrete (diaphragms not shown in the figure would stabilize the section). The top slab would be cast in place on top of the webs after lifting. This method of construction was used on the Denny Creek Bridge in Washington State.

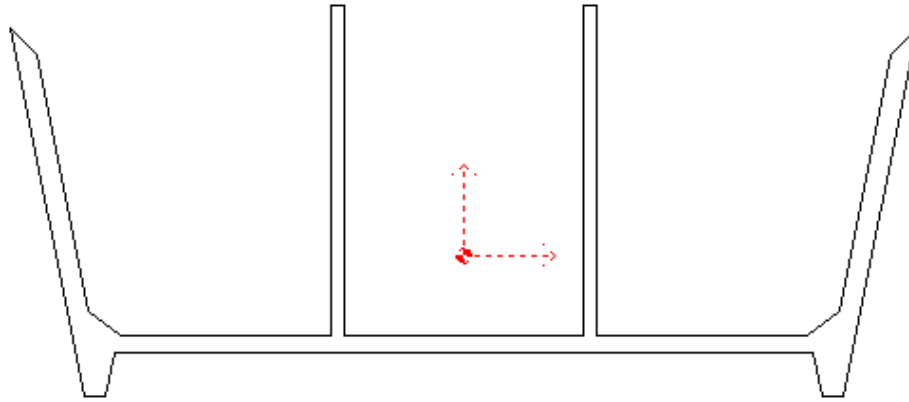

Figure 3.12. Cross Section for Heavy Lift

The longitudinal arrangement of segments erected by the heavy-lift technique is shown in **Figure 3.13**. The lifted segments are connected to the pier tables by cast-in-place closure pours. Post-tensioning tendons running through the closure pours and over the tops of the piers complete the connection and resist hogging moments induced by secondary dead load and live load.

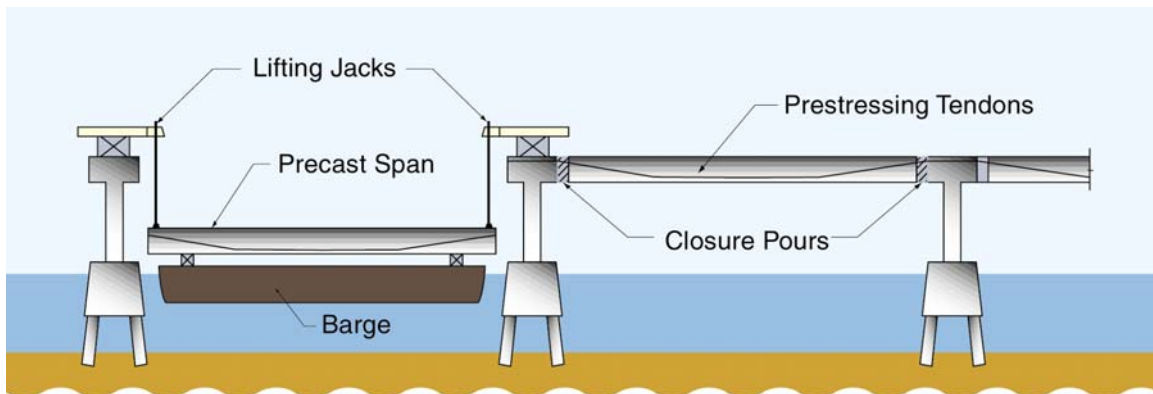

Figure 3.13. Post Tensioning with Heavy-Lift Construction

Balanced Cantilever Construction

All of the structural alternatives presented in this chapter could be constructed with the use of the balanced cantilever method of construction. This method of construction is illustrated in **Figure 3.14**. It is the norm for construction of cast-in-place (and precast) box girder bridges with spans of 300 feet or more.

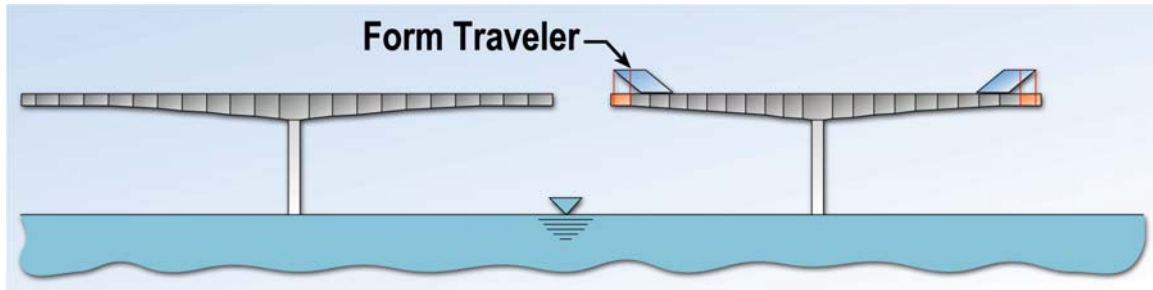

Figure 3.14. The Balanced Cantilever Method of Construction

In the balanced cantilever method of construction the structure is cast in segments, proceeding outward from each pier towards mid-span. The segments are typically on the order of 15 feet in length. Each segment is cast in forms supported by an overhead traveler fixed to the preceding segment (see **Figure 3.15**).



Figure 3.15. The Balanced Cantilever Method of Construction (Sun Yat-Sen Freeway)

After it is cast, each segment is connected to the previously completed structure by cantilever tendons running over the top of the pier. This arrangement of tendons is shown in **Figure 3.16**. Once the tendons are stressed, the form traveler is advanced onto the recently complete segment and construction of a new segment begins.

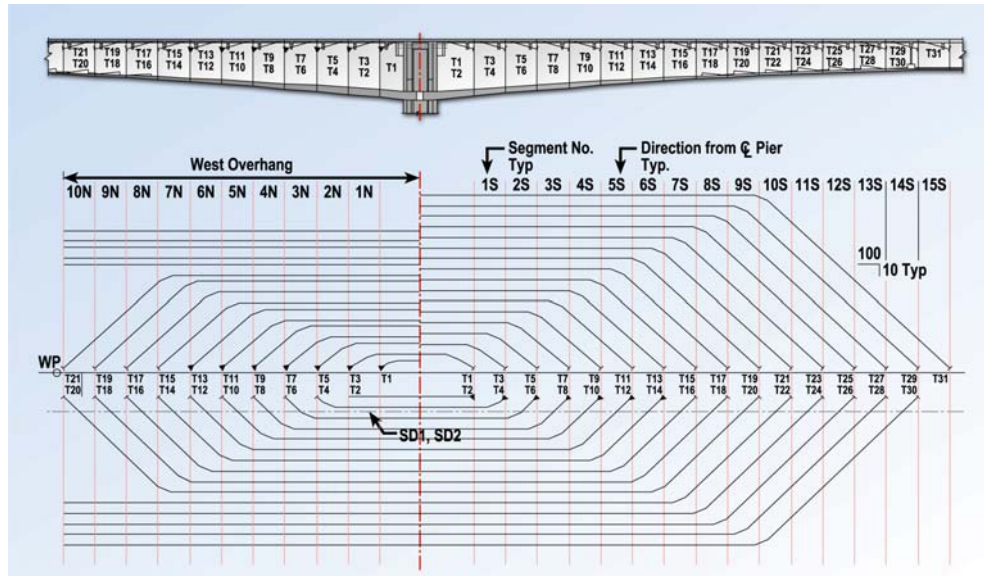

Figure 3.16. Arrangement of Cantilever Tendons

Adjacent cantilevers are joined by a closure segment cast near mid-span, as illustrated in **Figure 3.17**.



Figure 3.17. Casting of Closure Segment (Kramer-Rosecrans Bridge)

Cold-Weather Issues

The technology exists to cast concrete in subfreezing weather if the construction schedule dictates that this is necessary. The feasibility of construction in cold weather is demonstrated by the recent construction of the Wabasha Street Bridge in Saint Paul, Minnesota. This bridge was built with the balanced cantilever technique (Burgess). By using insulated forms and propane heaters to heat the forms, concrete was placed in

ambient temperatures as low as -19 degrees Fahrenheit ($^{\circ}\text{F}$). Whether cold-weather concreting is cost effective is a matter of economics—of cost versus schedule.

The feasibility of construction of segmental concrete bridges in northern climates is further demonstrated by the construction of the Confederation Bridge in Canada (<http://www.confederationbridge.com>).

3.2.3 Piers

The pier cross section shown in **Figure 3.18** may be used with any of the superstructure options presented earlier. This basic shape has been used on several bridges in California and is designed for a seismically active area like Knik Arm. As shown in **Figure 3.19**, the main reinforcement is placed in the four corners of the cross section and is heavily confined with closely spaced hoops to ensure ductile behavior. The cross section shown in the figure is from the new San Francisco-Oakland Bay Bridge.

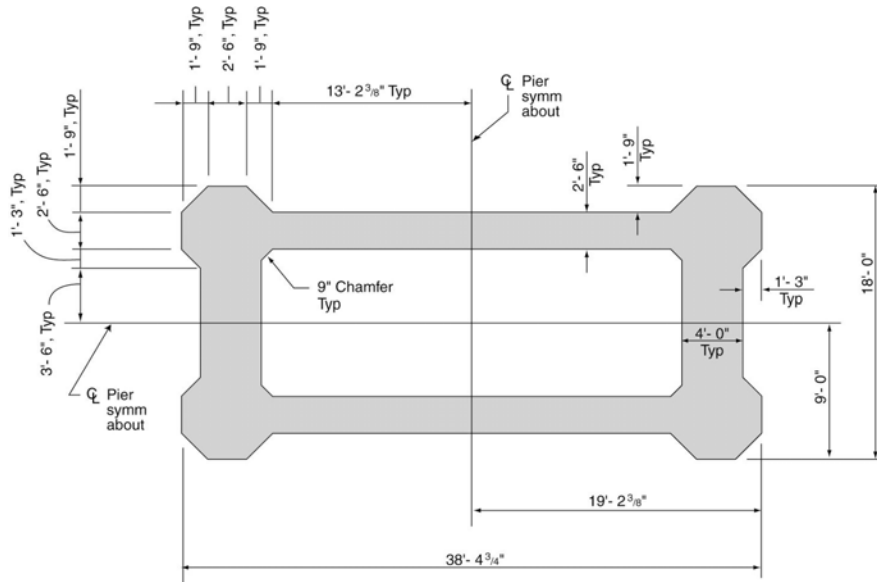

Figure 3.18. Pier Section

The piers will be very critical elements in the seismic performance of the bridge; probably they will be the only elements designed to yield during an earthquake. Recent proof testing at the University of California at San Diego showed excellent behavior of the San Francisco-Oakland Bay Bridge pier design; the test pier had a displacement ductility capacity of about eight in an area for which the demands are estimated to be less than three.

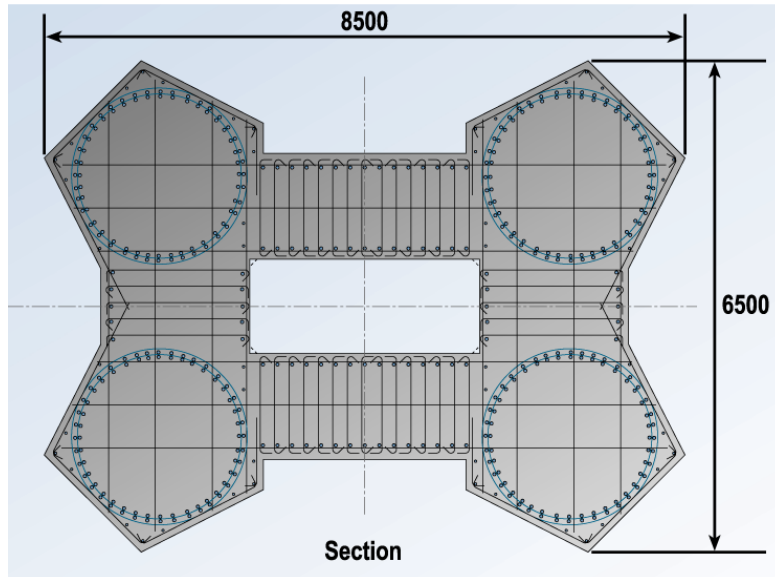

Figure 3.19. Reinforcement of Pier (San Francisco-Oakland Bay Bridge Section)

3.2.4 Pile Caps

The pile caps will need to perform two essential roles in a crossing of Knik Arm—connecting the piers and the piles and resisting boat impact and ice loads. The latter role is made more difficult by the large tidal range in Knik Arm, from Elevation +24 feet above mean sea level to Elevation -23 feet (FHWA and ADOT&PF, 1983a). To cover this whole range, the pile cap shown in **Figure 3.20** is 50 feet high and is situated between Elevations -25 and +25 feet above mean sea level. It is aesthetically preferable to cover the whole tidal range so that the structure presents a consistent appearance.

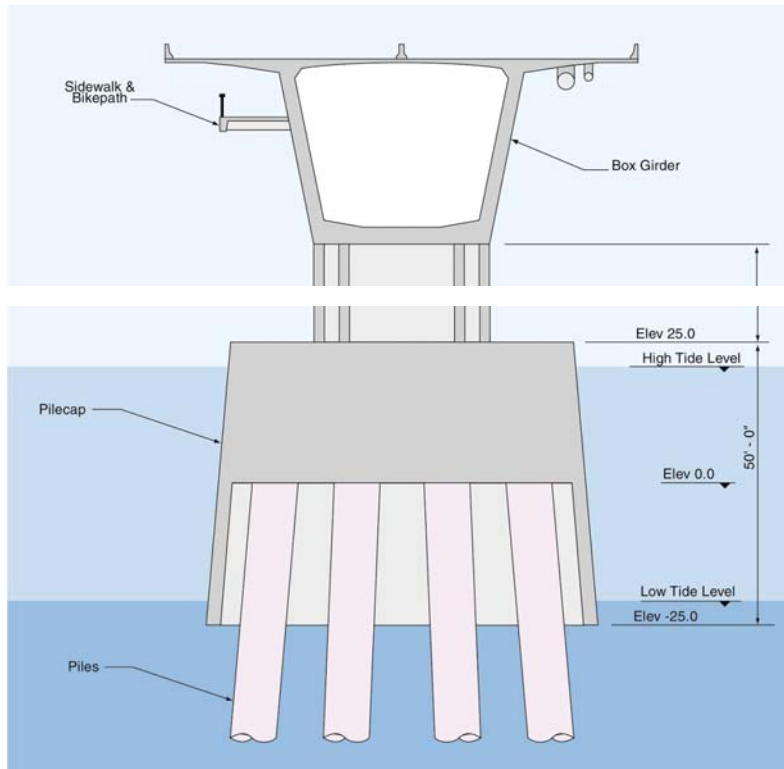

Figure 3.20. Pile Cap Elevation

The base of the pile cap is sized to accommodate a pattern of eight 8-foot-diameter piles arranged concentrically around the pile cap. The arrangement of piles shown in **Figure 3.21** assumes that the piles will be battered. If this is the case, the piles can be spaced only two pile diameters apart at the soffit of the pile cap; the normally required spacing of three diameters will be achieved at the pile tip through the batter. It is important to minimize the pile spacing at the soffit of the pile cap in order to minimize its plan area and mass. The pile cap shown in **Figure 3.21** weighs approximately 6,000 tons, which is comparable to the weight of the tributary portion of the superstructure. The mass of the pile cap will play a significant role in the seismic response of the structure, and the behavior of the structure will be improved as the mass of the cap is reduced.

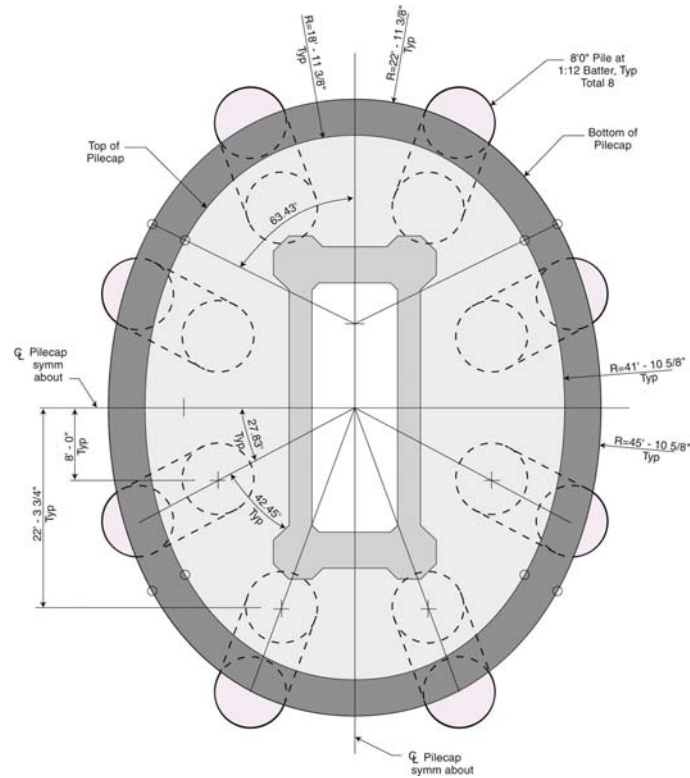

Figure 3.21. Pile Cap Plan

Construction of the pile caps will be a significant challenge. One possible approach—of many—is to construct the pile caps by filling precast shells of reinforced (and/or prestressed) concrete. Each shell would be placed over a group of previously driven piles. The weight of the skirt below the soffit of the cap would help to overcome the buoyancy of the shell at high tide. This means of construction is illustrated in **Figure 3.22**. Alternatively, there may be some advantage to placing the “void” in the pile cap at the top rather than at the bottom, as shown in **Figure 3.23**.

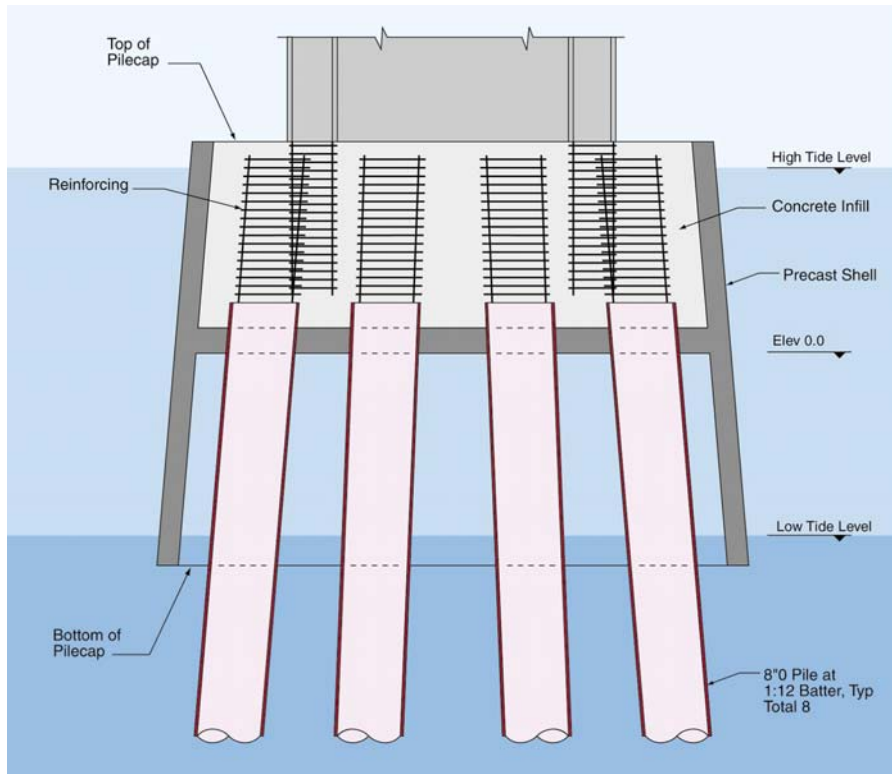

Figure 3.22. Pile Cap Section

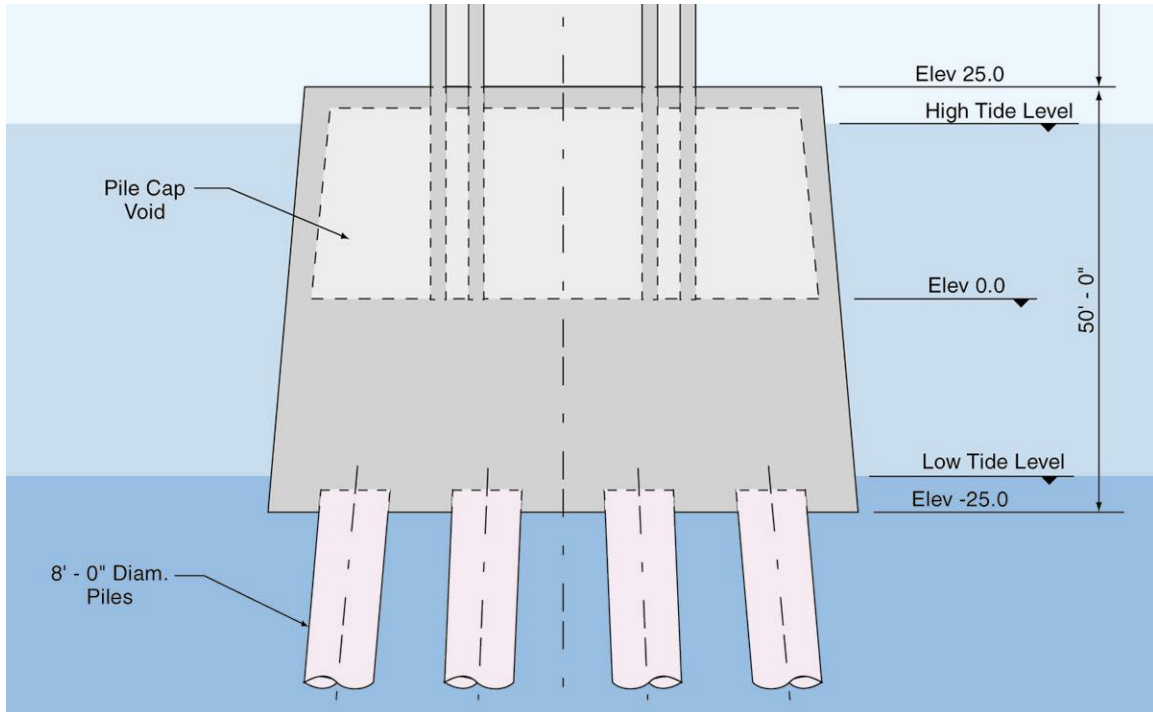

Figure 3.23. Alternative Pile Cap

The pile caps of the Jamuna River Bridge in Bangladesh were constructed with the use of precast shells, as shown in **Figure 3.24**.



Figure 3.24. Precast Pile Cap Shells (Jamuna River Bridge)

3.2.5 Piles

In recent years, several large concrete box girder bridges have been supported on large-diameter piles. The piles of the new San Francisco-Oakland Bay Bridge (see **Figure 3.25**) consist of 2.5-meter- (8.2-foot) diameter steel shells filled with concrete. The steel shells are 68-millimeter- (2.68-inch) thick where they enter the pile cap. This thickness is intended to resist driving stresses and to prevent local buckling of the shells under seismic loads. Similarly large cast-in-steel-shell (CISS) piles were used in the construction of the Jamuna River and Benicia-Martinez bridges.

As shown in **Figure 3.25**, the steel shells are typically filled with concrete for some depth below the mudline, and are reinforced to connect them into the pile cap. The reinforced concrete plug is made of composite, with the steel shell through shear rings welded to the interior surface of the shell.

Installation of piles of this size will be a formidable challenge. It may be necessary to use the very large pile hammers typically used in the construction of offshore oil platforms. The use of large-diameter piles in bridge design within the past decade has been motivated by their original use in the construction of offshore oil platforms.

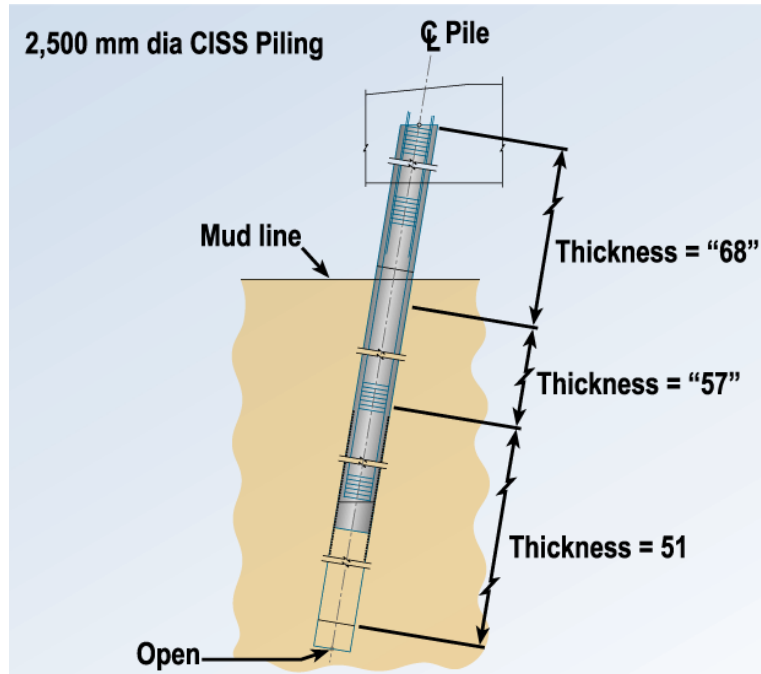

Figure 3.25. Large-Diameter CISS Pile (San Francisco-Oakland Bay Bridge)

Large-diameter piles will be best able to tolerate scour up to 50 feet deep (see below). Including scour, water depths will be more than 100 feet. Liquefaction of surficial soils during an earthquake will reduce the available lateral support and also increase the unsupported length of piles. This earthquake impact also argues in favor of large-diameter piles.

If installation of large-diameter piles proves impractical, smaller-diameter pipe piles may be considered. Such piles are commonly used in the Anchorage area. Pipe piles up to 36 inches in diameter have been used at the nearby POA, and preliminary design plans call for 48-inch-diameter piles at the POA Intermodal Marine Facility (ADOT&PF, 2002b).

3.2.6 Loads

3.2.6.1 Live Load

Vehicular design loads should be in accordance with the American Association of State Highway and Transportation Officials (AASHTO) code in effect when the bridge is designed. This could be either the HS20 (or HS25) load in the Standard Specifications or the HL-93 load in the Load and Resistance Factor Design (LRFD) Specifications. The bridge concepts included in this study provide four vehicular lanes.

Structures intended to carry rail should be designed for the Cooper E80 load shown in **Figure 3.26**. On a 400-foot span, this load is roughly equivalent to about ten lanes of vehicular traffic (additional to the actual vehicular lanes).

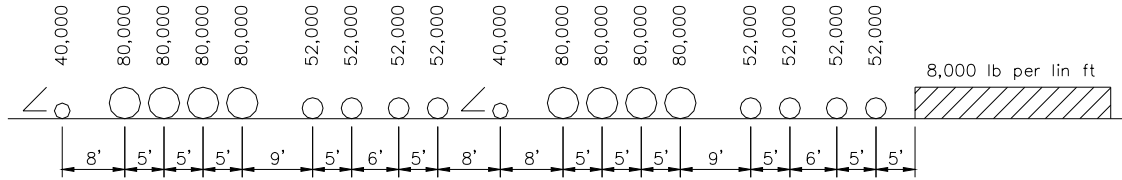

Figure 3.26. Cooper E80 Live Load

3.2.6.2 Earthquake

On Good Friday 1964, the Anchorage area was subjected to the second largest earthquake ever recorded (moment magnitude $M_w = 9.2$). This earthquake caused extensive damage throughout the area and caused the Million Dollar Bridge near Cordova to partially collapse. The earthquake was caused by movement on a portion of the Alaska-Aleutian megathrust subduction zone (where the Pacific plate is being subducted beneath the North American plate). Major events on this portion of the subduction zone have a recurrence interval of approximately 750 years (Shannon & Wilson, 2001a). If the expected life of the Knik Arm Crossing is 100 years, there is 13 percent chance of a comparable event occurring during the life of the structure. The probability of a large earthquake may actually be higher, considering events on other parts of the subduction zone and on other faults. Other than dead loads, seismic loads are likely to be the controlling influence on the design of the substructure of the bridge.

Loading

The response spectrum recommended in the Knik Arm Crossing Foundation Update Memorandum (ADOT&PF, 2002b) for a 2,500-year recurrence interval is shown in **Figure 3.27** (design for a 1,000-year return-period event may also be sensible, but this would not be significantly less intense than the 2,500-year event). The peak ground acceleration for this return period is 0.55g. Of greater significance to the design of the main crossing structure is the intensity of the design spectrum at long period. The structure is likely to have a fundamental period of vibration in the three- to five-second range. The spectral intensity at a 3-second period is approximately 0.45g for the 2,500-year event.

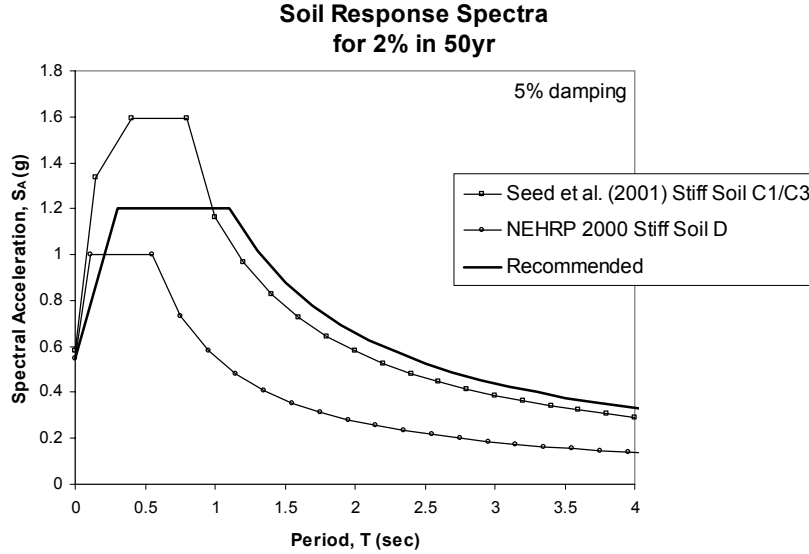

Figure 3.27. Response Spectrum for 2,500-Year Event

The 2,500-year response spectrum shown in **Figure 3.27** may be compared with the spectra used for design of the new San Francisco-Oakland Bay Bridge, shown in **Figure 3.28**. The spectra are of depth-variable motions and the kinematic motions that effectively drive the structure for both vertical and battered pile foundations. The heavy dashed curve marked “Battered Piles” is the key curve for comparison with **Figure 3.27**, because the San Francisco-Oakland Bay Bridge is founded on battered piles. The Bay Bridge motions are relatively intense at long period because of amplification of the motion through soft soil layers, not because the rock motions are particularly intense at long period.

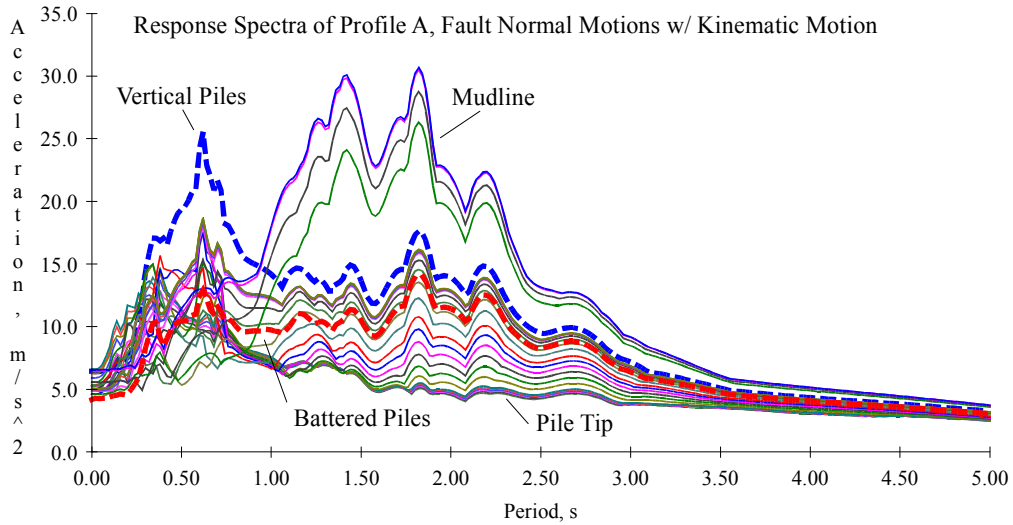

Figure 3.28. San Francisco-Oakland Bay Bridge Design Spectra ($g=9.8 \text{ m/s}^2$)

The response spectra for “Battered Piles” in **Figure 3.28** is for the kinematic motions that effectively drive the structure. The spectral intensity at a three-second period is about six meters-per-second squared m/s^2 , or about 0.6g, which is greater than the corresponding value of the 2,500-year event recommended for the Knik Arm Crossing. This comparison helps to demonstrate the feasibility of a concrete box girder crossing of Knik Arm. Ground motions in the Anchorage area are no more severe than those used for the design of similar structures in the San Francisco Bay Area. A concrete box girder crossing of Knik Arm should be feasible if similar design approaches and details are used.

Behavior

A crossing of Knik Arm should be designed to not collapse in a major earthquake like the 2,500-year event described above. But major damage, even unreparable damage that would require replacement of the structure (or at least its piers), could be allowed. The duration of subduction zone events is a significant factor in this regard. The duration of strong shaking is greater for the 2,500-year events than it is for other types of earthquake. Although the duration of strong shaking is not typically considered in the seismic design of structures, somewhat greater damage could occur in a subduction zone event. (It is possible to consider the duration of an event and quantify damage by using the concept of cumulative ductility.)

It would also be sensible to design for repairable damage for events smaller than those described above; for example, earthquakes with a return period of 1,000 years. The damage would be quantified by strains in concrete and reinforcing steel, and those strains would be limited to control the damage. This criteria would likely control over a criterion of major damage in a 2,500-year event.

Major structures are often designed to be undamaged in frequently occurring earthquakes, such as those with a return period of 100 years. This objective is achieved by designing for essentially elastic response. The response spectrum recommended in the Knik Arm Crossing Foundation Update Memorandum (ADOT&PF, 2002b) for a 100-year recurrence interval is shown in **Figure 3.29**. It is relatively intense compared to the 2,500-year-event spectrum shown in **Figure 3.28** (0.18g versus 0.45g at a three-second period). This low-level event could significantly affect the design of the structure, depending on the performance criteria for the project.

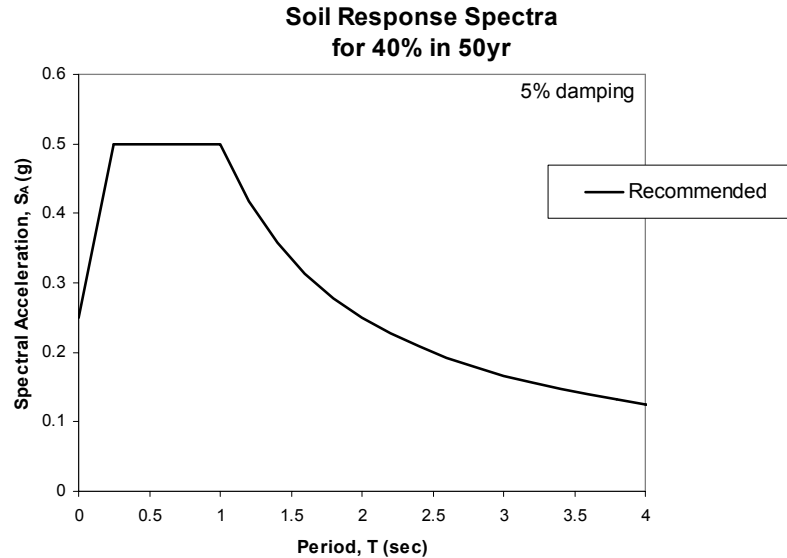

Figure 3.29. Response Spectrum for 100-Year Event

Most of the earthquake damage to the structure should be to the piers. These are the only locations where plastic hinges are expected to occur (see **Figure 3.30**). By design, hinges should not be allowed in the superstructure or the piles, and there should be little damage in those locations. Isolating damage only to the piers allows for relatively rapid inspections and repairs with a minimum disruption to functions.

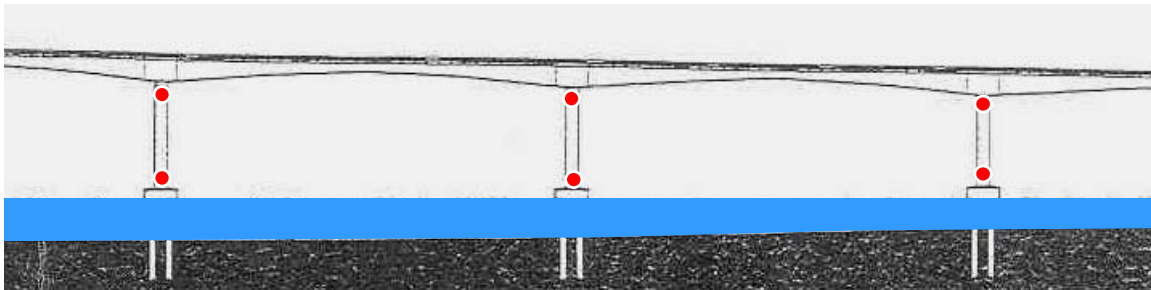

Figure 3.30. Location of Plastic Hinges in Piers

The foundations of the structure will affect its seismic response in at least two ways. First, the mass of the pile cap may be a significant fraction of the total mass of the structure, as much as 33 to 50 percent. The seismic behavior of the bridge will be improved if this mass is minimized. But, if the pile cap is to cover the whole tidal range of the Knik Arm—which is aesthetically preferable and prevents ice loads from acting on the piers and piles—the pile cap may be 45 to 50 feet high. The volume of the pile cap can be minimized by using a skirt, as shown in **Figure 3.22**, or a void, as shown in **Figure 3.23**. The plan area (and volume) of the pile cap can be minimized by reducing the pile spacing at the soffit of the cap. Minimization of pile spacing will require the use of battered piles to achieve reasonable pile spacing at the pile tip.

Second, the effect of battered piles on the seismic response of the structure will need to be carefully studied in a pile-soil-structure interaction analysis. For the San Francisco-Oakland Bay Bridge, situated over soft soils, battered piles were found to generally improve the seismic behavior of the structure.

3.2.6.3 Ice

Loading

The maximum *sustained* ice thickness observed in Knik Arm during the years 1963 to 1980 is 28 inches, during the winter of 1964-65 (FWHA and ADOT&PF, 1983b). The sustained thickness is the average thickness of ice over a week-long period. The maximum reported thickness is 48 inches during the same 17-year period. This includes rafted ice, where one ice sheet is rafted on top of another. The data collected during the years from 1963-1980 (FWHA and ADOT&PF, 1983b) are extrapolated to obtain the ice thickness corresponding to a 100-year return period. These thicknesses are 36 inches for a single layer of ice and 72 inches for rafted ice.

Assuming a single 36-inch layer of ice and average ice strength of 300 pounds per square inch (psi), the force exerted on a 50-foot-wide pile cap would be about 6,500 kips. This force is less than, but of the same order of magnitude as, the seismic load on a pile group.

Design

Large ice forces also argue in favor of a battered pile group. Battered piles will minimize the size of the pile cap exposed to ice, and they will also be better able to resist ice loads than will vertical piles.

A key issue in the design for ice loading is the height of the pile caps. These are shown in all of the figures as extending above the highest tide and below the lowest tide, making them 45 to 50 feet high. Extending the pile caps above high tide prevents ice from hitting the pier proper and damaging it exactly where plastic hinges are expected to form in an earthquake. It may also be aesthetically preferable to carry the pile caps above high tide. Piers protruding directly from the water may be unappealing in a long viaduct-like structure. Also, pile caps immediately below the water surface may be a navigation hazard, because boaters are likely to be unaware of their presence just below the water line.

Extending the pile caps below low tide prevents ice from hitting the piles, reducing the danger of damaging these critical structural elements. Pile damage would be very difficult to repair. Also, it is aesthetically preferable to cover the whole tidal range so that the structure has a consistent appearance. The pile caps should be shaped to manage the effects of ice on the structure. First, the upstream and downstream faces of the caps should be rounded or made with a knife edge to break through the ice and reduce the chance of ice sheets jamming against the bridge. Second, the pile caps should be made with sloped faces. If the slope is sufficiently great, it will help to break up any ice moving against the pier—the ice will ride up the pile caps and fail in bending.

The pile cap concepts discussed in this study must be considered as preliminary and basic. The interaction of ice and structures is complex, particularly in the case of the Knik Arm crossing, considering the large tidal range. Some creativity will be needed to develop a pile cap design that will best manage the ice and its effects on the structure.

3.2.7 Knik Arm Oceanographic Conditions

This section addresses the in-water conditions at the location of the crossing. This information is needed for consideration in the constructability of the bridge.

3.2.7.1 Tides

Tidal ranges for Knik Arm in Anchorage were obtained from the National Oceanic and Atmospheric Administration (NOAA), National Ocean Service, website (2002) and checked against 1996 data (NOAA) with all values agreeing to within one tenth of a foot. Following are the tide data from Anchorage Station 9455920 dating to May 1964:

- Maximum water level (10/24/1980): 34.55 feet above mean lower low water (MLLW)
- Mean higher high water: 29.01 feet above MLLW
- Mean high water: 28.30 feet above MLLW
- Mean tide level: 15.30 feet above MLLW
- Mean low water: 2.30 feet above MLLW
- Mean lower low water: 0.00 feet above MLLW
- Minimum water level (03/25/67): 6.21 feet below MLLW

3.2.7.2 Currents

The U.S. Army Corps of Engineers funded a field study in 1992 that included Acoustic Doppler Current Profiler (ADCP) measurements of current across two transects in the vicinity of the proposed Hybrid Alignment crossing. One transect was located on the narrowest portion of Knik Arm at Cairn Point and the other transect was approximately one mile upstream of Cairn Point, which is approximately one mile downstream of the proposed crossing. The transect closest to the proposed crossing was used to estimate flow speeds at the proposed crossing, which are expected to be conservative approximations because the flow speeds appear to decrease with increasing distance upstream from Cairn Point. The maximum observed velocities at the transect one mile south of the proposed crossing were approximately 3.3 knots and were measured during a tide range of approximately 21.4 feet. The maximum velocity is relatively constant across the center portion of Knik Arm. For the purposes of this study, the observed velocities were used to estimate the vertically averaged velocity associated with an extreme tidal fluctuation of 40 feet as outlined herein.

Following the FHWA guidance for simplified estimation of tidal currents on evaluation of scour at highway bridges (2001; Section 9.4.5), the maximum vertically averaged velocity can be converted from one tide range to another based on a direct proportionality between the maximum velocity and the tide range. For purposes of this study, a maximum tide range of 40 feet was used to estimate maximum tidal currents and scour

due to the bridge. The maximum observed water levels during the past 38 years, which occurred at completely different times (13 years apart), correspond to an excursion of 40.8 feet. For this study, velocities are assumed to be vertically averaged, unless otherwise stated. Converting the maximum observed velocity of 3.3 knots from a tide range of 21.4 feet to 40 feet yields a velocity of approximately 10.5 feet per second. Because of the approximate nature of the calculation a velocity of 11 feet per second is assumed for the extreme tide variation of 40 feet.

In a report on acoustic Doppler and backscatter data, Lohrmann and Brumley (1992) state, “Except near slack tide, the velocity profiles are similar to those found in rivers...” as opposed to a vertical velocity distribution that may be heavily affected by flow stratification. Therefore, the velocity of 11 feet per second should be assumed in scour calculations for the bridge.

3.2.7.3 Scour

The scour calculations were calculated based on the proposed bridge pier section, FHWA methodology, and the following assumptions:

1. Maximum tidal range of 40 feet with a peak ebb tide velocity of 11 feet per second occurring at mean tide level, which is approximately 15 feet above MLLW.
2. The bridge pier was assumed to consist of an eight-pile group of 10-foot-diameter piles extending from the mudline (-45 feet MLLW) up to the elevation of low water associated with the 40-foot tide (assumed to be 5 feet below MLLW). The depth of pile exposure due to the current before any scour was 40 feet. The pile cap was assumed to extend from 5 feet below MLLW to the water surface at mean tide level (approximately 15 feet MLLW) (rounded to the nearest foot). Therefore, the pile cap is assumed to be exposed to 20 feet of water at maximum ebb tide. In summary, the pile cap extends from the water surface to 20 feet below the surface.
3. Piles extend from the bottom of the pile cap to the mudline at a depth of 60 feet below the water surface (-45 feet MLLW).
4. The pile cap is assumed to be solid and have a width of 80 feet (25 meters) perpendicular to the direction of flow (the plan form width as viewed from the direction of flow). The piles are assumed to have a diameter of 10 feet and a batter of 1H to 10V, giving average pile spacing between centerlines at the mudline of 25 feet.

Calculating the scour with the equations for contraction scour and pier scour due to complex piers yields contraction scour of 6 feet and 44 feet for pier scour, for a total of 50 feet. Although there appears to be evidence of long-term scour on the left bank of Knik Arm, this area of significant scour overlies a hard substrate. In the center of the channel, there does not appear to be any evidence of significant long-term scour, and at this level of analysis, the scour values presented above are suggested for design without any additional scour from long-term degradation.

Before design, a significant field effort that includes current measurements during spring tides and an analysis of all available historical bathymetric data in the vicinity of the proposed crossing is recommended.

3.2.7.4 Waves

Wind waves at a location near the proposed site were analyzed in a 1972 report for the Alaska Department of Highways (Howard, Needles, Tammen & Bergendoff, 1972). Maximum design wave heights of 15.0 feet and 10.8 feet were calculated for winds from the north and south, respectively. An analysis was conducted to determine the percentage of the wave height above the still water level by using the Stokes theory of second order wave (Sarpkaya and Isaacson, 1981). The results indicate that the wave crest can be assumed to reach an elevation of 9 feet and 10 feet above the still water level in water depths of 50 feet or less and greater than 50 feet, respectively.

3.2.8 *Feasibility and Cost*

The ultimate feasibility of a Knik Arm Crossing is not in doubt. In overall scale, the bridge is comparable to other structures built in the past decade. The bridge, however, will have to face a possibly unique combination of environmental conditions: cold weather, high seismicity, ice loads, and a large tidal range. But the meteorological conditions and seismicity are no more severe than those encountered elsewhere. The ice loads and tidal range combined may make a crossing of Knik Arm unique. But the ice loads are of reasonable magnitude; what is needed is an innovative design that will manage the ice effectively.

3.2.8.1 Comparable Projects

There are at least four projects from which useful experience and lessons may be drawn to benefit the planning and final design of a Knik Arm Crossing. These projects are described below.

Confederation Bridge

The Confederation Bridge (see **Figure 3.31**) links Prince Edward Island and New Brunswick in Canada. This bridge may be instructive for cold-weather construction technology and for design approaches to resist ice loading.

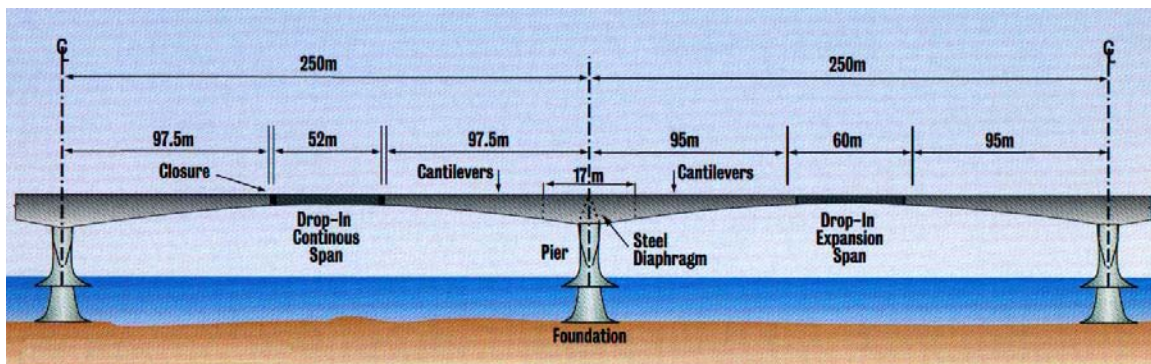

Figure 3.31. Confederation Bridge

Benicia-Martinez Bridges and San Francisco-Oakland Bay

Both the San Francisco-Oakland Bay and Benicia-Martinez bridges are now under construction across San Francisco Bay (see **Figures 3.32** and **3.33**, respectively). They may be instructive for the seismic design of a crossing of Knik Arm.



Figure 3.32. Benicia-Martinez Bridge



Figure 3.33. San Francisco-Oakland Bay Bridge

Jamuna River Bridge

The Jamuna River Bridge (see **Figure 3.34**) crosses the Jamuna River in Bangladesh. This bridge may be instructive for its precast pile caps and the feasibility of installing very large-diameter piles (3.15 m diameter).



Figure 3.34. Jamuna River Bridge

3.2.8.2 Cost Breakdown

The estimated cost of a Knik Arm Crossing is contained in Volume 3 of this Update Project (Schedule, Cost, Contracting, and Finance Report). Some general facts about the costs of major water crossings are included in the discussion below. The cost breakdown for a typical, prestressed, segmental, box girder bridge is shown in **Figure 3.35**. The figure shows that the piers and foundations of a bridge together typically make up about 30 percent of the total cost of the structure and that the superstructure cost is about 70 percent of the total.

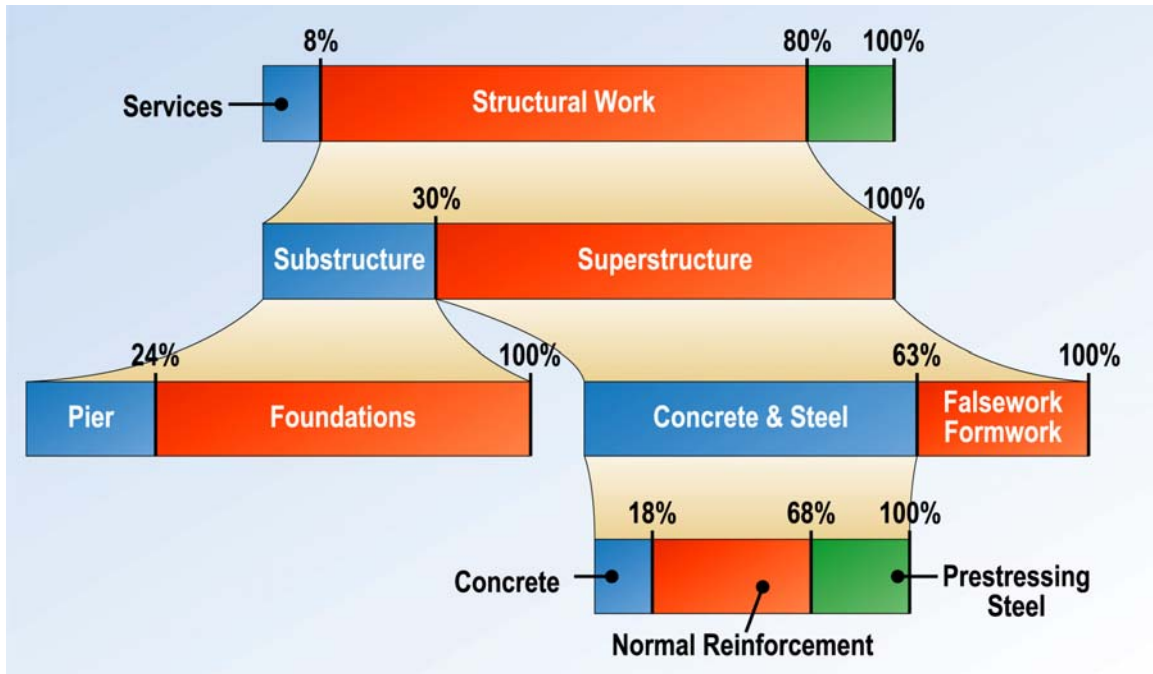

Figure 3.35. Typical Cost Breakdown (from Schlaich and Scheef, 1982)

These typical ratios may not be applicable to a major water crossing of Knik Arm, however. Recent experience with concrete box girder crossings of major water bodies suggests that the foundations and piers may be of comparable cost to the superstructure. Cost ratios for the San Francisco-Oakland Bay and Benicia-Martinez bridges now under construction across San Francisco Bay are shown in Figure 3.36.

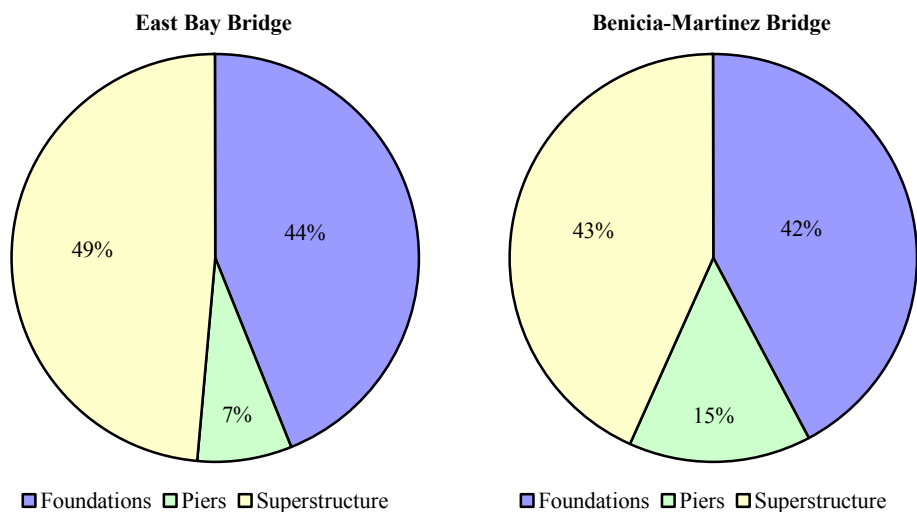

Figure 3.36. Cost Ratios for Major Water Crossings

Of particular importance to this project, the data suggest that the foundations may equal the superstructure in cost. The conditions affecting the cost of the foundations of a crossing of Knik Arm—water depth, seismicity, ice loads, and a large tidal range—are at least as severe as those encountered by the San Francisco-Oakland Bay and Benicia-Martinez bridges.

3.2.9 Conclusion

This chapter presents feasible structural alternatives for a crossing of Knik Arm along the Hybrid Alignment. These structural alternatives include prestressed, segmental, concrete box girder bridges with spans between 400 and 600 feet. Options discussed are road-only structures and structures able to carry both vehicular traffic and heavy rail. For further study and costing, the most promising of the rail alternatives appears to be track located on top of the box girder.

The environmental conditions that will affect the design of the structure include deep water, cold weather, high seismicity, ice loads, and a large tidal range. These conditions do not appear to present any insurmountable obstacles to either design or construction, although they will affect the final cost.

4.0 TUNNEL TECHNOLOGY AND ALTERNATIVES

4.1 Summary

In the 1984 DEIS (ADOT&PF and FHWA), a tunnel crossing the Knik Arm for vehicular traffic was studied and eliminated from consideration because of costs and technical issues. The Update Project re-examines the feasibility of a crossing tunnel by aligning along a Hybrid Alignment and taking advantage of any advancements in the tunneling industry.

The most significant tunneling changes since 1984 when the DEIS was prepared are in the increased size of bored tunnels and the modernization and increased production aided by slurry-pressure balance support, computerized processes, and more accurate guidance systems. The operations of a tunnel remain centered around incident detection and life safety issues while advancements have been made in video surveillance and traffic messaging.

Two basic tunneling methods were examined in this study, immersed tube (IMT) and bored. The IMT method is technologically feasible, but had serious issues that could raise construction risk and therefore costs. The bedding and foundation material in place for IMT placement is unstable within the channel due to grain size and high-velocity currents. The currents and extreme tide variation would make positioning and assembly of the IMT very problematic. The bored tunnel presented issues in the grain size of the bored materials and the high pressures needed to “hold back” the forces acting on the exposed heading. Both tunnels would require a ventilation system that would potentially require shafts extending above the water surface at several locations along the length of the crossing.

A twin bore tunnel was used for the purposes of establishing the baseline crossing cost for the tunneling alternative. Shoulder widths and vertical clearance within the tunnel have been sized to the minimum widths allowed by standards. A larger single bore or the immersed tube is not eliminated from further consideration; however, the construction cost derived for the twin bore tunnel is judged to be the most likely method to be used and was therefore used to develop the estimated tunnel crossing costs.

4.2 Tunnel Technology Update and Assumption

This section addresses the two primary tunnel crossing methods: IMT and bored tunnel. Given the conditions of the Knik Arm Crossing, the preferred method is identified as a bored tunnel.

4.2.1 Immersed Tube Tunnels

The IMT crossings can be desirable alternatives to fixed crossing at locations where subsurface construction conditions are particularly difficult or where fixed crossing are undesirable because of environmental or operational considerations. Immersed tunnels have been constructed in many locations around the world and in the United States in San Francisco, Boston, and New York. Since 1984, there have been advancements in global positioning control but not in the basic technology.



The most interesting feature of the use of an IMT approach is the relationship between the tunnel structure and its water environment. Apart from other construction methods, the immersed tunnel is reliant on the presence of water. This condition differentiates the immersed tunnel design from convention tunneling. The presence of water serves three important functions for an IMT:

1. Enables a massive prefabricated element to be delivered to the site and placed with great delicacy and precision
2. Provides the buoyant tunnel that reduces the applied stress on the foundation to levels
3. Mobilizes the natural hydrostatic forces to actually join and seal the units together, providing a more waterproof structure

The construction of an immersed tunnel begins with the remote fabrication of tunnel elements or sections. The IMT tunnel elements are like a series of pipe or precast concrete elements that are then transported to the crossing site and joined to form a continuous tunnel structure.

The IMT system requires sealing fabricated tunnel sections in the fabrication area and making them watertight. The units become floating vessels that are towed to the construction site. The site is prepared in advance by excavating a trench in the bed of the waterway. The trench aligns below the IMT tunnel sections and provides the foundation of the tunnel.

The floating tunnel elements are lowered into the trench by a variety of rigging control systems to manipulate the buoyancy of the section so that a controlled and precise placement is accomplished. The tunnel is formed by the sequential connection of the prefabricated tunnel elements. Following placement and joining of the tunnel elements, the completed tunnel structure is backfilled and covered with a layer of armor rock to protect the tunnel from scour, damage caused by ships, or anchor drag.

The site conditions at the proposed Knik Arm Crossing along the Hybrid Alignment present foundation and construction difficulties. The material on the bottom of the Knik Arm is loose to medium dense sands that have demonstrated lateral movement and scour in the channel and would make a poor quality foundation for an IMT. The extreme high water in the Knik Arm is at an elevation of 24 feet above mean sea level; the extreme low water is at Elevation -23 feet and currents are as high as eight knots. These conditions would make precision positioning and securing of the large tunnel sections a considerably difficult construction task.

4.2.2 Soft-Ground Bored Tunnels

Since completion of the 1984 DEIS, there have been significant advances in soft-ground tunnel technology. Excavation of earth or soft ground tunnels has evolved during the last 20 years from the use of liners or shields that were forced ahead and excavated with backhoes or rudimentary cutting heads in compressed air to the use of earth-pressure balance and slurry-type machines for tunnel boring.

Advances in tunnel boring machines (TBMs) have allowed high rates of productivity while maintaining worker safety, even within extreme geologic conditions. Computer-controlled guidance and operating systems have given engineers a level of precision unknown until now. Experience tunneling crews have the ability to work in concert with these highly automated systems, anticipating the performance characteristics and alignment for the TBM. There is a trend toward increasing bore diameters, as shown in **Figure 4.1**.

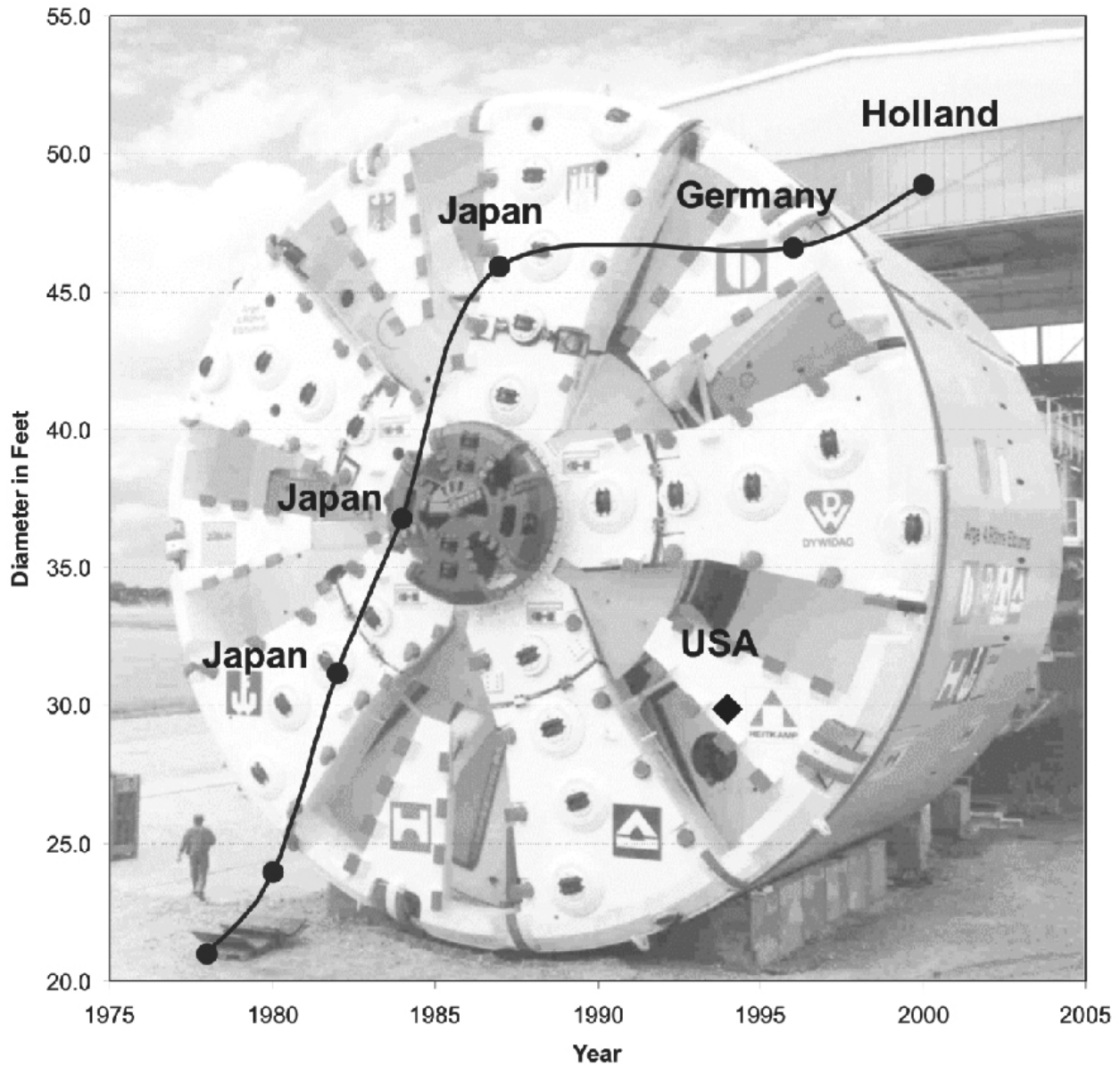

Figure 4.1. Increased Size of Bored Tunnels

The general principle of the shield is based on a cylindrical steel assembly pushed forward on the axis of the tunnel while excavating the soil. The shield has to supply a counteracting force pressure to the surrounding ground and prevent groundwater from entering. The steel shield assembly supports the excavated void until the final tunnel lining is assembled.

In addition to the shield support, a face support system must allow for advancement of the tunnel excavation and removal of muck while applying a counteracting force pressure to the tunnel face

ground and prevent groundwater from entering the tunnel. There are five recognized methods for face support:

- Natural
- Mechanical
- Compressed air
- Slurry
- Earth-pressure balance

Figure 4.2 below shows a diagram of the following four applied face support systems:

- Natural and mechanical face support—The Knik Arm soil composition and high certainty of presence of water make these methods of face support unlikely.
- Compressed air—Health problems associated with long-term exposure to compressed air and lack of productivity from long decompression time for workers have limited the use of compressed air to less than 20 psi. Pressures of up to 40 psi are anticipated for the Knik Arm Crossing. Compressed air for a face shield does not seem practical.
- Slurry support—The excavated soil is mixed with slurry and removed from the tunnel with a slurry pipeline while providing a closed face and isolated pressure face at the tunnel heading. This system is being used in tunnels the size of one required for a Knik Arm Crossing and in similar soft-ground soils. This system was used as a basis for costing.
- Earth-pressure balance—This method is generally limited to diameter of bores that are smaller than needed for a Knik Arm tunnel.

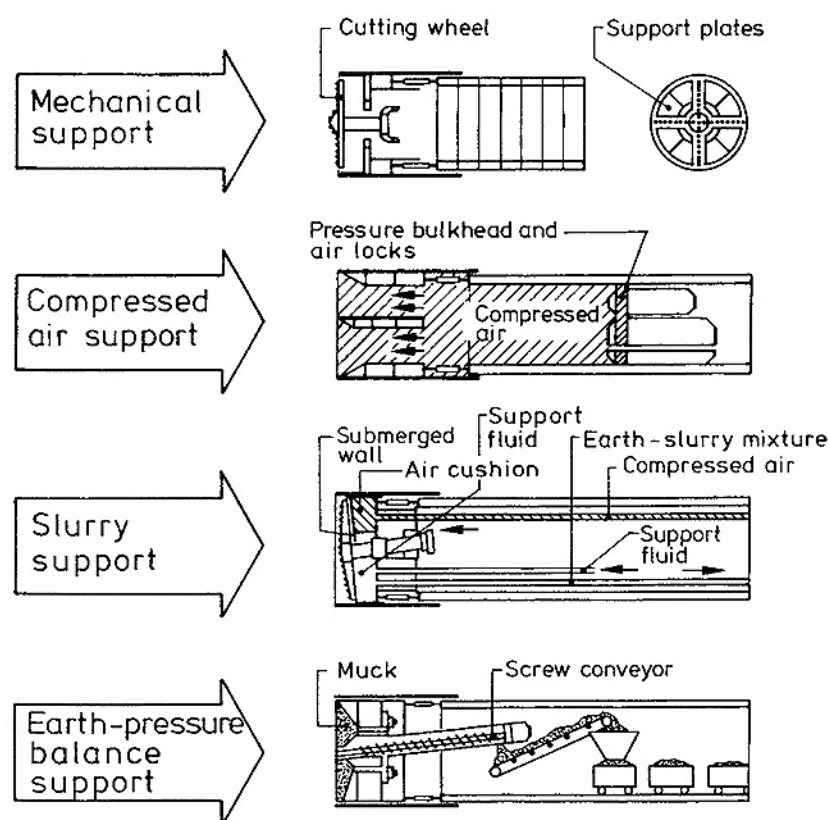

Keeping out groundwater and supporting the ground at the tunnel face (Mechanised shield tunneling; Maidl, Herrenknecht, Anheuser)

Figure 4.2. Tunnel Support Systems

4.2.3 Tunnel Bores in Coarse-Grained Soils

Clean to silty sand, gravelly sand, sandy gravel, gravel, and cobbles will tend to flow into the tunnel excavation if left unsupported and when subject to a hydrostatic water pressure estimated to be up to about 100 feet of water head at selected locations. These soils are water-bearing and will flow any pipe fines into an unsupported excavation or through any openings in the TBM or liner, unless they are positively supported, dewatered, or both. They will also require the addition of varying amounts of chemical or clay conditioners to stabilize the cohesionless granular soils during excavation with an earth-pressure balance machine (EPBM). Bentonite additives would likely be used with a slurry-pressure balance machine (SPBM). Periodic weekly (or more often) access to the cutter head requires that these flowing soils be stabilized by compressed air. If the compressed air is not sufficient, then grouting or freezing may be required. The coarse-grained soils are very abrasive and will cause significant wear to TBMs.

The coarse-grained soils will have highly variable stand-up times. Where the sands are dry, above the natural groundwater table, the material will tend to ravel, much like hourglass sand. Where wet, these soils will tend to flow, but will be temporarily stable when dewatered, due to

the presence of negative pore pressures. Where zones of clean gravel and cobbles occur, very heavy water inflows will occur, unless the soils are appropriately dewatered. Such conditions would generally not be a major issue unless the cutting chamber is evacuated for cutter repair. For this condition, the stand-up time would also be a function of the effectiveness of compressed air, the stability of the filter cake, or the soil exposed in the face.

4.2.4 Tunneling Bores in Fine- and Coarse-Grained Soils

The anticipated mixed face condition consists of layers of fine-grained soils (silts, clay, and peat) interbedded with the coarse-grained soils. The coarse-grained soils along the tunnel horizon are water-bearing soils. Coarse-grained units above and below the fine-grained soils may be indicating partially perched or poorly connected groundwater regimes. Therefore, the TBM may be subject to minor differential hydrostatic pressures in the excavation face, which may cause some challenges in maintaining face stability, potentially when crossing from predominantly fine-grained soils to coarse-grained soils in either the crown or the invert of the advancing tunnel. This condition is exacerbated with such a large-diameter machine.

4.3 Tunnel Boring Machines

There are very few TBMs of approximately 50 feet diameter in the world. NFM Technologies of France designed and built a 48-foot, 10 ½-inch-diameter TBM for the Groene Hart Rail Tunnel in Holland. This machine is claimed to be the world's largest diameter at this time. The machine uses the patented Benton air system, which consists of a combination of pressurized slurry systems. The TBM used for the Elbe River Highway Tunnel had a diameter of 40 feet 2 inches, which in the year 2000, was a world record.

4.3.1 Slurry-Pressure Balance Machines

SPBMs have been used extensively in the United States for microtunneling (typically in the 5- to 15-foot-diameter range). In an SPBM, the excavated soil is mixed with slurry and removed from the tunnel with a slurry pipeline while providing a closed face at the tunnel heading. SPBMs can be operated remotely with few or no personnel at the heading. During normal excavation and lining erection, there would not be personnel at the heading, inside the cutting chamber. Personnel would only access an evacuated cutting chamber for cutter repair and maintenance.

SPBMs have not been used in the United States for excavating larger-diameter, long tunnels that use a single- or double-pass erected lining system. Most of the larger machines (12 to 25 feet diameter) in the United States have typically been the somewhat simpler and less expensive EPBM.

The SPBM consists of a heavily reinforced steel cylindrical shell, with a rotating cutter head mounted on the front. Bentonite slurry is injected into the cutter head and mixing chamber to lubricate, apply pressure to the excavated soil face, resist water inflow, and carry the cuttings through pipeline back to the launching shaft. Cobbles and small boulders (less than about two to three feet) may be broken up with a mechanical "rock crusher" chamber at the bottom of the head. Disc cutters are normally mounted on the rotating head along with drag picks, in an

attempt to break up boulders. If large boulders cannot be broken up, however, the face must be pressurized with compressed air, grouted, or frozen and workers must break the boulders into manageable sizes. Because the face is completely closed off and filled with pressurized slurry, these machines also greatly reduce the inflow of methane gas, if it is present in the soils.

The excavated spoil or muck is carried by a pipeline back to the launching area where multiple settling tanks and a cyclone separator are used to remove the granular soils from the clay slurry, which is then recycled back to the tunnel machine. If the spoil is a clayey sand, the clay particles would tend to mix into the slurry as suspended solids, potentially altering the physical and chemical properties of the slurry. The degree of alteration would depend on the amount of fresh bentonite added to the system as the machine advances. Continuous and routine testing at the treatment plant would detect the degradation of slurry properties to determine when and if any action is required. For CL-type soils with substantial cohesion, it is likely that the clay would be excavated in chunks and removed on screens at the slurry treatment plant, with minimal contamination of the bentonite slurry.

4.3.2 Earth-Pressure Balance Machine

EPBMs have been developed to excavate a wide range of soils with groundwater levels of up to about 200 feet above the tunnel invert. EPBMs have been used extensively in the United States for the last 20 years to excavate wet soils where dewatering or the use of compressed air is either too expensive or prohibited by concerns about settlement and worker safety. EPBMs have been used to excavate two- to four-mile-long sections of 12- to 15-foot-diameter tunnels in abrasive ground and with water heads in excess of 200 feet.

The EPBM consists of the cylindrical shield, which supports the ground and protects the workers. The soil heading is completely closed off with a steel bulkhead that permits the development of a positive pressure against the excavated soil surface. The EPBM restricts the flow of excavated soil from the face of the rotating cutter head by controlling the rate of rotation of an enclosed muck-removal auger that indexes into the back of the cutter head bulkhead. Slowing the speed of the muck-removal auger results in a backpressure effect that counteracts the inward movement of the soil from the tunnel heading. For predominately wet sands and gravels, the auger may be lengthened and special gates or pistons may be installed at the outlet end of the auger to limit the pressure drop and excessive flow rate during ejection of wet granular soils.

In wet, cohesionless silt, sand, and gravel, soil conditioners, such as bentonite (clay), foaming agents, or polymers, must be added to the face to give the soils a cohesive consistency necessary for maintaining face stability and controlled flow of soils through the muck-removal auger. These same conditioners also help to reduce friction and abrasion on the head and cutter teeth and reduce the amount of torque needed to rotate the cutter head. In some instances, bentonite clay, silt, sand, and vermiculite have been injected into very gravelly soils at the face to produce a more plastic behavior of these excavated soils.

To excavate boulders, EPBMs may be outfitted with disc cutters designed to break up rock, if it can be held in place by the face pressure of the rotating cutter head. In some instances, dislodged

boulders may still roll around in front of the advancing machine, causing excessive soil excavation, surface settlements, and abrasion and damage to the disc cutters. In these instances, the face must be stabilized by using grout or be pressurized with compressed air, allowing workers to enter the tunnel heading and manually break the boulders into manageable sizes.

An EPBM was used to excavate two Seattle, Washington, tunnels: the two-mile-long Alki CSO Tunnel and the 6,000-foot-long Denny CSO/Mercer Street Tunnel. On both projects, the highly abrasive nature of the sands, gravels, and glacial tills resulted in some damage to the rotating cutter head that required up to one month of repair time. Such abrasion-induced damage can be reduced by proper maintenance of the cutter head, including frequent inspection of the condition of the drag picks and cutter teeth and replacement of worn teeth every 200 to 500 feet.

The EPBM technology has been used on several tunnels in granular soils with water heads of 100 to 200 feet. Most notable of these is the San Diego Sewer Outfall Tunnel that was driven through more than 19,000 feet of granular to clayey soils and weak rock, with scattered cobbles and boulders out beneath the Pacific Ocean and groundwater heads of up to 200 feet. The tunnel was driven with a 13-foot-diameter EPBM. The nearly seven bars of water pressure were resisted by extending the screw auger, adding a positive flow-restriction gate at the outlet end of the auger, and injecting abundant bentonite, polymer and foam additives to the excavated face and soil in the screw conveyor.

The TBM for the proposed 48'-56' diameter tunnels of the Knik Arm Crossing would likely be a custom-designed, specially manufactured machine to meet the project needs in the terms of size and expected ground and groundwater conditions. From a design standpoint, a machine this size would likely be a slurry machine because of somewhat lower torque and power requirements and the more efficient balancing of variable groundwater pressures over a very large-diameter tunnel head with slurry versus the EPBM. Slurry machines tend to be more costly to construct and to maintain than EPBMs, and also require a larger staging area to recycle the slurry and separate the muck (cuttings) for disposal.

4.3.3 Cutter Head Wear

Excessive wear of the rotating steel cutter head and cutters is anticipated in the fluvial deposits due to the very abrasive nature of the coarse-grained soils. The SPBM must be designed to provide frequent access to the cutter head to periodically replace the picks and other cutting tools. This access may involve the use of airlocks to provide access to the cutter head under compressed air. Drill ports will also be required in the shield skin and cutter head to allow the drilling of freeze holes or grout holes to stabilize the face in the extreme event that dewatering or the use of compressed air is not sufficient. The cutter head will likely require a complete overhaul and resurfacing after completing each drive.

4.3.4 Tunnel Support

Single-pass lining methods primarily consist of gasketed segmental concrete liners that provide a final watertight structural liner. Concrete segments are manufactured at a plant where quality of the segments can be controlled. The segments are designed to interlock precisely. Tapered

lining rings could also be used to accommodate vertical and horizontal curves. A single-pass system is preferable to a two-pass system because of potentially high groundwater pressures that would generally not have to be reduced before tunneling, ease of construction, and watertightness.

Tunnel support in and around the cut-and-cover approach sections to the main crossing would require either dewatering or freezing techniques for construction. Proper groundwater treatment and disposal would need to be addressed.

Cracking and spalling of the segments may occur if the machine wanders off alignment or if sloppy workmanship is used. Usually the problems increase if crews rush to increase daily production. For segment damage occurring during transport and handling, the segment should be rejected for installation until a suitable repair is made. Only when a segment is already installed and is irretrievable should damage be accepted without segment replacement. Segment cracking under the thrust of the advancing machine is not necessarily common, but it does occur and can be corrected by checking and correcting for ring planarity before advancing the TBM again. Many times tension cracks develop under the thrust of the machine when the last ring is out of plane, but as the tail void grout is placed and the soil and water loads come onto the lining as it leaves the tailskin, the cracks close under ring compression so that they are barely detectable.

A lining finish is usually provided to facilitate ventilation airflow and light reflectivity and to support mechanical and traffic equipment.

4.3.5 Tunnel Tour

Members of the Update Project team (ADOT&PF and Parsons Brinckerhoff) embarked on a four-day tour of selected European tunnels from October 21 to 24, 2002. The following tunnels were visited:

- Westerschelde Tunnel, Belgium
- North-South Metro, Antwerpen, Belgium
- Herren Tunnel, Lubeck, Germany
- Warnow Tunnel, Rostock, Germany

4.3.5.1 Tunnel Tour Findings

Major findings from each tunnel are summarized below:

- Westerschelde Tunnel is similar to a tunnel suitable for crossing Knik Arm in characteristics of cross section, length, bore diameter, soft-ground boring, and depth. Given that all other factors are the same, tunneling across the Knik Arm is feasible. However, many factors still need to be researched (actual geotechnical information, water pressures, currents, and tidal fluctuations).

- TBMs are reused from tunnel to tunnel. Consistent and in-depth maintenance is required during the construction life. These maintenance times must be factored into the boring and project schedules. Additional costs are required for maintenance.
- A highly technical team of TBM and tunneling geotechnical specialists worked full-time during the boring phases of the projects. This availability of technical experts allows for quick and cost-effective responses to any type of problem that may occur. It is recommend that these technical specialists be included in the cost of a Knik Arm Crossing project.
- In addition, a full-time crew of tunneling divers was assembled and incorporated into the regular work shifts so that they would be immediately available if necessary. Again, this staffing allows for the quick and cost-effective response to any problems that may occur during the boring phases of a tunneling project. It is recommend that these special divers be included in the cost of the project.
- Expert and experienced panel manufacturing is key to the structural integrity of the tunnel walls. The location of manufacturing for molds and panels will dictate construction and costs. Local versus foreign manufacturing, integrity of the raw materials, shipping of finished products, and expertise and experienced workers in this unique specialty are issues to be addressed and that will determine costs.

4.4 Analysis

4.4.1 Crossing Location and Geologic Setting

The subsurface conditions in the vicinity of the crossing have been characterized by the profile in **Figure 4.3**. This section was taken from Plate 5 of the HLA 1984 report and has been modified to include recent subsurface information from the nearby Port MacKenzie Dock project as well as reconnaissance mapping of the bluffs in 1971. Soil units were also extrapolated into areas where conditions were not well defined on this profile and represent assumed conditions that were needed to develop construction costs in these areas. Although this profile closely skews across the selected hybrid alignment, it is the most credible deep subsurface information prepared for the Hybrid Alignment. For cost-estimating purposes, similar subsurface conditions along the preferred hybrid alignment will be assumed.

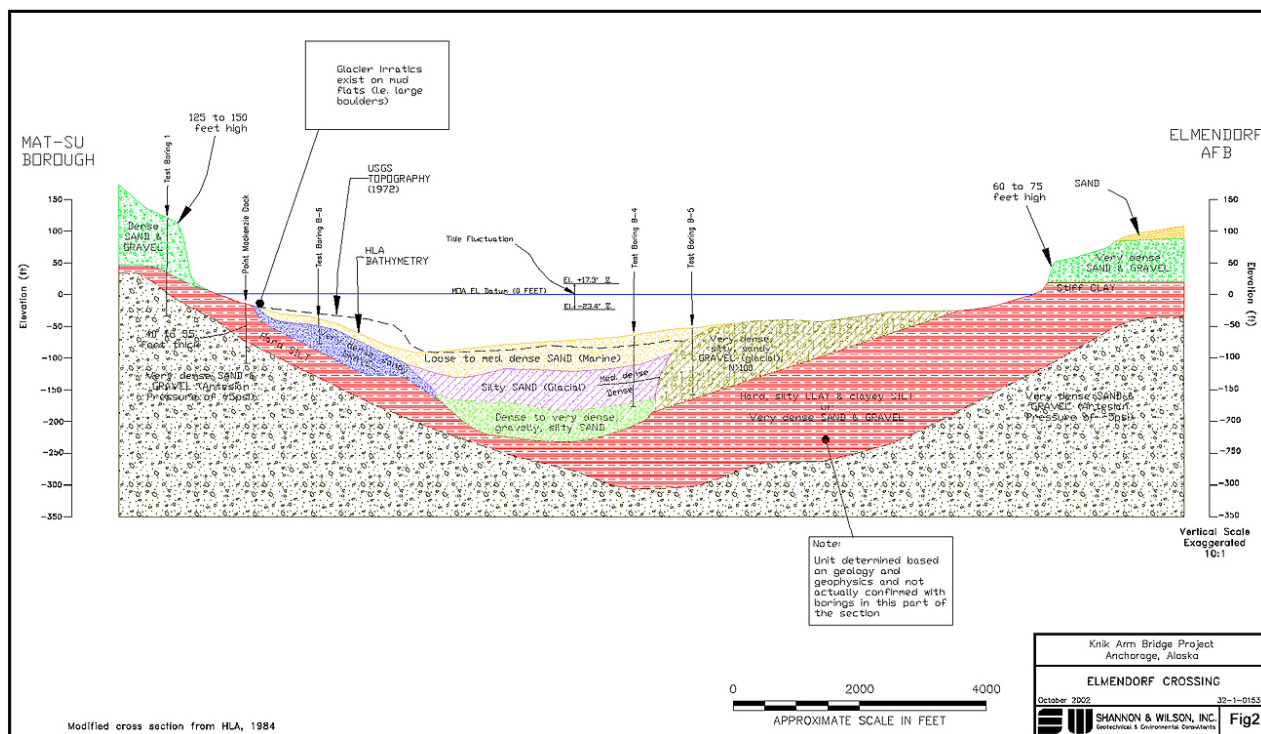

Figure 4.3. Crossing Foundation Conditions

This profile shows a surficial marine deposit of 20 to 35 feet of loose to medium-dense sands overlying very dense granular tills or glacio-fluvial deposits or hard glacial clays and silts. Prior studies indicate that the marine deposited sands in the upper 35 feet are loose enough that they will scour under the strong six- to eight-knot currents and more than 40-foot tides or liquefy under strong earthquake shaking.

The deeper granular or clay soils, because of their density or hardness, are not prone to strength losses under seismic loading and are resistant to scour. Of these compact materials, the silty clays unit is best suited for driving a tunnel beneath this channel. This material was formed as a glacial lake as part of glacial advances in the region and reaches depths of more than 200 feet in the POA area directly to the south. With glacial advances and retreats in a north-south direction up Knik Arm, the clay is scoured or overlaid with glacial till or other moraine deposits, as shown on the profile.

Near the crossing site, this glacial clay is exposed in the east bank and, from geophysical and geological interpretations in the HLA 1984 report, is reasonably thick below the east half of the crossing. Its thickness or presence on the east side is not confirmed by borings. From borings at the Port MacKenzie Dock on the west side, glacial clay thins to 40 to 55 feet and grades to a silt or clayey silt. On the basis of the profile, this cohesive unit is assumed continuous across the channel.

Other notes on the profile indicate small artesian pressures (about 5 psi) in the deepest till unit and glacial erratics (large boulders) on the mudflats at low tide near the Port MacKenzie Dock.

These pressures are based on past borings drilled below the clays into similar soils at the POA. The erratics indicate that large boulders are present within the glacial tills as well as infrequently in the clays. The presence of artesian pressures or boulders could affect tunnel-driving operations (as described below).

The actual subsurface conditions will be more extensively investigated if a tunnel alternative is pursued because the soil type can have a large impact on the feasibility and cost of driving a tunnel. For estimating purposes, it is recommended that this unit be treated as a low plasticity clayey silt or silty clay.

4.4.2 Design Criteria

Tunnel facilities, equipment, and operations and maintenance requirements have been addressed for the Knik Arm Crossing project. Fire and life safety criteria for road tunnels are based on National Fire Protection Association (NFPA) 502 Standard for Road Tunnels, Bridges and Other Limited Access Highways. This national standard is established by the NFPA and recognized by the FHWA.

The design criteria will comply with applicable NFPA, ADOT&PF, and MOA local requirements including the following:

- ADOT&PF Design Manual, Standard Plans and Specifications
- MOA Requirements for Electrical Service Connection

4.4.2.1 Fire and Life Safety Standards and Codes

- NFPA 10 Standard for Portable Fire Extinguishers, 1998 edition
- NFPA 13 Standard for the Installation of Sprinkler Systems, 1999 edition
- NFPA 14 Standard for the Installation of Standpipe, Private Hydrant, and Hose Systems, 2000 edition
- NFPA 20 Standard for the Installation of Stationary Pumps for Fire Protection, 1999 edition
- NFPA 70 National Electrical Code, 2002 edition
- National Electrical Safety Code, 2002 edition
- NFPA 72 National Fire Alarm Code, 1999 edition
- NFPA 101 Life Safety Code, 2000 edition
- NFPA 1963 Standard for Fire Hose Connections, 1998 edition

4.4.2.2 Lighting Standards and Codes

- American National Standards Institute (ANSI)/Illuminating Engineering Society (IES) RP-22 American National Standard Practice for Tunnel Lighting
- AASHTO Informational Guide to Roadway Lighting
- ANSI/IES RP-8 American National Standard Practice for Roadway Lighting

4.4.2.3 Ventilation and Emergency Egress Standards and Codes

- The criteria for emergency exits are based on NFPA 502 and NFPA 101, Life Safety Code. Only the exit design and construction requirements from NFPA 101 should be applied to tunnels. It is not the intent of these requirements to have the travel distances required within NFPA 101 to be applied to tunnels.
- The Memorial Tunnel Fire Ventilation Test Program (MTVTP) provides additional information on the design of road tunnel ventilation systems.
- Note: The criteria for ventilation and emergency exits exclude bicycle and pedestrian access or having bi-directional traffic in the same tunnel bore.

4.4.3 *Tunnel Operations Assumptions*

4.4.3.1 Operational Concept

The overall tunnel operating and maintenance strategy concepts for a Knik Arm Crossing project is presented in this study to identify the civil, structural, traffic, electrical, and mechanical design requirements for tunnel-related equipment that meets fire and life safety needs and operational requirements.

Every underground and overhead roadway system has its unique characteristics, and the Knik Arm Crossing project is no exception. To provide an efficient and safe facility for the motoring public, this project requires the utmost in planning and design, considering the facility's unique characteristics, all of which occur within an enclosed and limited access environment.

Tunnel systems must provide for the safe and efficient traffic movement through the tunnel. To accomplish these goals, the following activities are necessary:

- Early detection of traffic incidents
- Continuous monitoring, control, and logging of traffic and environmental conditions
- Communications with emergency services such as fire and police
- Visual traffic monitoring
- Safe and orderly procedures for motorists in case of incidents and fires
- Quick and safe evacuation routes

An additional goal is to facilitate maintenance by providing the following:

- A cost-effective design
- Integration with other ADOT&PF tunnel facilities.
- A common equipment inventory

4.4.3.2 Incident Impacts on Freeways

An "incident" is an accident, vehicle breakdown, spill, or other event that affects normal traffic flow. An incident can be as serious as blockage of all or part of the roadway or as minor as an event that causes a momentary distraction for the motorist. Unlike recurring congestion (such as

morning and afternoon rush hours) whose time span and location are usually predictable, the time and location of congestion created by an incident is unpredictable.

4.4.3.3 Incident Impacts in Tunnels

The Knik Arm Crossing tunnels would have additional hazards beyond the standard freeway hazards because of the restricted space in which vehicles travel. Therefore, the responsibility for providing smooth traffic flow through Knik Arm Crossing tunnels is greater than on the open freeway. Incidents that occur in a tunnel can potentially result in greater risk to motorists than similar incidents on an open expressway. Constant monitoring and control are required for prompt detection, response, and clearing for any incident that occurs in or near the Knik Arm Crossing tunnels.

Sixty percent of all accidents are secondary accidents—accidents that occur as a result of a primary accident. Particularly in a tunnel environment, these secondary accidents need to be reduced or eliminated. The quick detection, verification, and dispatching of clearance teams and the proper response and evaluation are critical for the safety of both motorists and response personnel.

4.4.3.4 The Incident Management Process

Figure 4.4 describes potential equipment, communications and coordination that a Tunnel Control Center (TCC) may have with motorists, recovery crews, fire department, state patrol and police department, emergency services, and the media.

The operational goals for incident management of a Knik Arm Crossing are as follows:

- Incident detection within 30 to 60 seconds from the incident occurrence
- Incident verification within 30 to 60 seconds from detection
- Incident plan implementation within two to three minutes from verification
- Response to the scene within five to ten minutes from incident verification

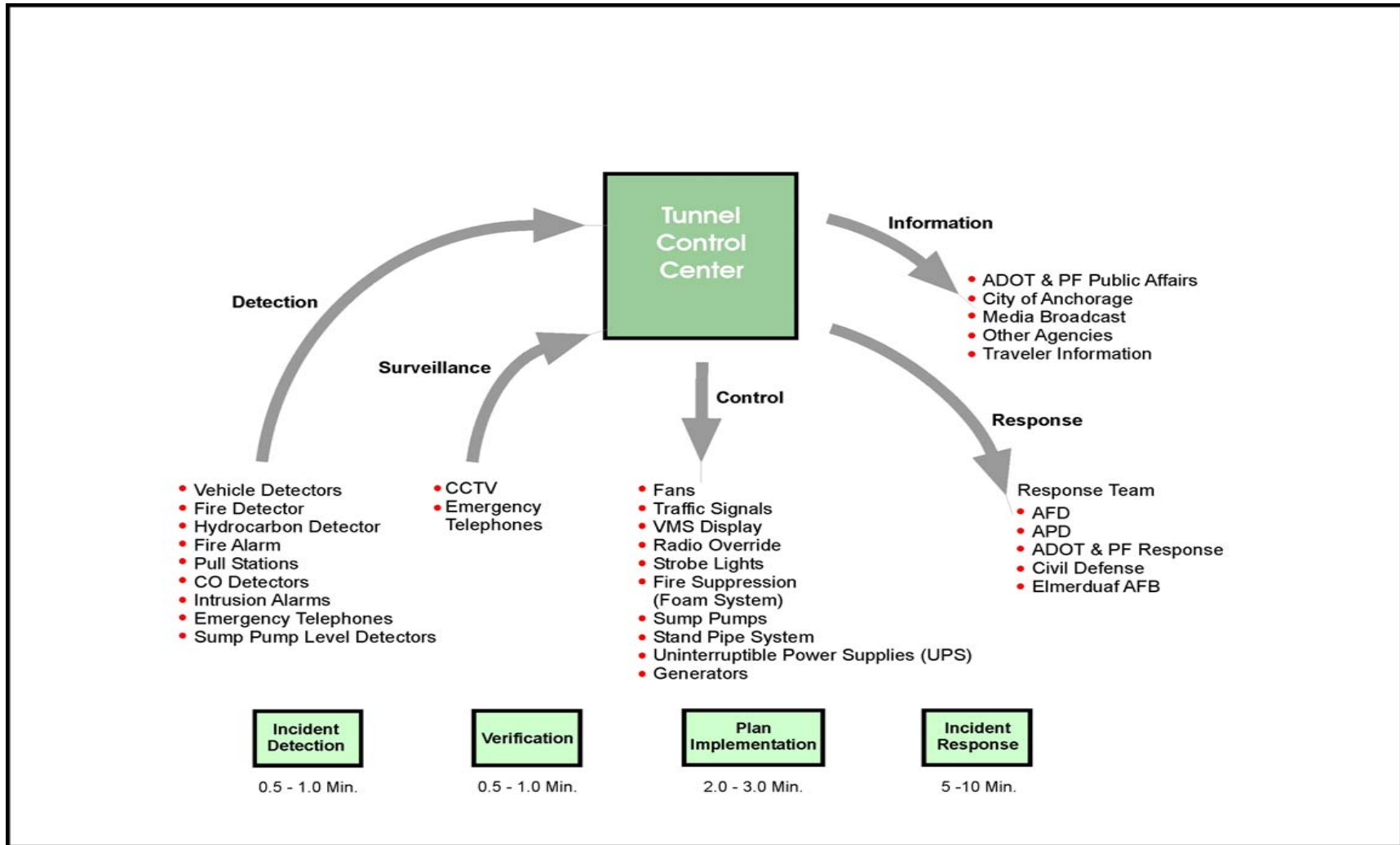

Figure 4.4. Tunnel Incident Management Process

The overall performance goal is for the first emergency crews to be on the scene within 10 to 15 minutes from the occurrence of any incident.

Table 4-1 outlines the types of equipment that tunnels typically employ for various incident scenarios. This equipment is identified to provide a basis for developing operational and design criteria for a Knik Arm Crossing project. Final selection of equipment will occur during subsequent phases of the design process. Equipment is further differentiated within the table according to the appropriate phase of the incident management process. Incidents range from minor incidents such as a disabled vehicle or debris in the roadway to major incidents, fires, hazardous spills, or power outages.

Table 4-1. Incident Management Process System Equipment

Mode	Detection	Verification	Implementation/Response
Minor Incidents	Vehicle Detectors CCTV ET Intrusion Alarms CO Detectors	CCTV ET Devices Monitor	Tunnel Signals VMS Ventilation Fans
Accidents	Vehicle Detectors CCTV ET CO Detectors	CCTV Devices Monitor	Tunnel Signals VMS Radio Override Ventilation Fans
Fire	Vehicle Detectors CCTV Manual Fire Pull Stations Fire/Heat Detectors	CCTV ET Devices Monitor	Tunnel Signals VMS Strobe Lights Ventilation Fans Radio Override Hydrants
Hazardous Spills	Vehicle Detectors CCTV ET CO Detectors Hydrocarbon Detectors	CCTV ET Devices Monitor	Signals VMS Radio Override Ventilation Fans Hydrants Sump Pumps Drainage Valves
Flooding	Sump Pump Level Detectors	CCTV	Tunnel Signals VMS
Power Failure	Automatic Transfer Switch	Devices Monitor	Generator Automatic Transfer Switch UPS
Air Quality (CO Buildup)	CO Detectors	Devices Monitor	VMS Radio Override Ventilation Fans

CCTV – Closed Circuit Television

CO – Carbon Monoxide

UPS – Uninterruptible Power Supply

ET – Emergency Telephone

VMS – Variable Message Sign

In addition to the tunnel systems addressed in the above table, the tunnel operations should also be tied into the MOA traffic signal system and ADOT&PF corridor management tools—Intelligent Transportation Systems (ITS) and Rural Weather Information Systems (RWIS). This coordination will improve traffic flow onto city streets during incidents requiring tunnel evacuation and during normal periods of traffic. Tunnel status (open or closed) and other traveler information can be disseminated to the traveling public through the media, Internet, and ITS equipment located throughout the corridor.

Incident Detection

Prompt detection of an incident is critical in limiting the effects on safety in tunnels. Detection is the action taken to make the responsible authority aware of an event that may affect tunnel operations. By detecting (and responding to) an incident that may be initially very minor (such as a disabled vehicle in the roadway), a secondary incident may be avoided. For a Knik Arm Crossing project, the incident detection time criterion is set at 30 to 60 seconds.

Detection devices include various vehicle detectors, closed-circuit television (CCTV), fire detectors, manual fire alarm stations, carbon monoxide (CO) detectors, intrusion alarms, high-water-level detectors, and hydrocarbon detectors.

Other forms of detection may include cellular calls to 911, information from other control centers, and radio communications from the incident response teams, service patrols, ADOT&PF personnel, Anchorage Police Department (APD), Anchorage Fire Department (AFD), and Alaska State Troopers.

Verification and Identification of Incidents

Once an incident has been detected, it is important for the tunnel operator to correctly assess the situation and swiftly implement the appropriate incident plan to avoid loss of valuable time. During many emergencies, several types of incidents may occur simultaneously. The operator must be able to identify and prioritize based on the emergency's complexity.

For a Knik Arm Crossing project, the goal is to verify and assess the type and severity of the incident in less than one minute from detection. The operator will assess the incident type and severity and the damage to vehicles and the tunnel. The operator will also determine if there are any potential injuries, and then dispatch the appropriate response agency.

CCTV and emergency telephones are two primary means of verifying and identifying the type and severity of incidents, accidents, and fire.

Incident Plan Implementation

In all cases where an incident or an alarm is detected, the operator will be presented with a menu (directly on a monitor screen) of responses suitable for the particular situation, which may vary depending on the severity of situation. Through this selection process, predefined system-response modes (plans) are implemented automatically. This approach to dealing with incidents and alarms is widely used in tunnels throughout the world.

The goal is to deploy the desired incident plan within two to three minutes of verification. Actions could range from simply turning on ventilation fans to closing one or both of the Knik Arm Crossing tunnels.

Final incident plans must be developed during the final design process.

Incident Response

The proper dispatch of emergency response agencies is key to the success of the incident management process.

Emergency response units should arrive on the scene within five to ten minutes after being dispatched. The response scenarios to be developed for the project should include provisions to expedite the travel of emergency response units on surface streets and help them gain access to an incident scene as soon as possible.

During peak hours, dedicated response crews could be temporarily stationed at the portal locations of the tunnel (both ends) so that they would be able to quickly respond to incidents in any portion of the tunnel.

4.4.4 Tunnel Section

Two tunnel configurations were considered for the bored Knik Arm crossing. Both configurations are illustrated in **Figures 4.5 and 4.6**. The first is the traditional twin tunnel approach in which two parallel tunnels carry opposite directions of traffic and are connected with cross passages that are later mined between the tunnels following their construction. The cross passages serve as means of egress in the event of a fire or other emergency. The advantage of this approach is that the overall size of each tunnel can be kept to a minimum. The disadvantage is that mining of the cross passages is both costly and presents significant risk in a subaqueous crossing.

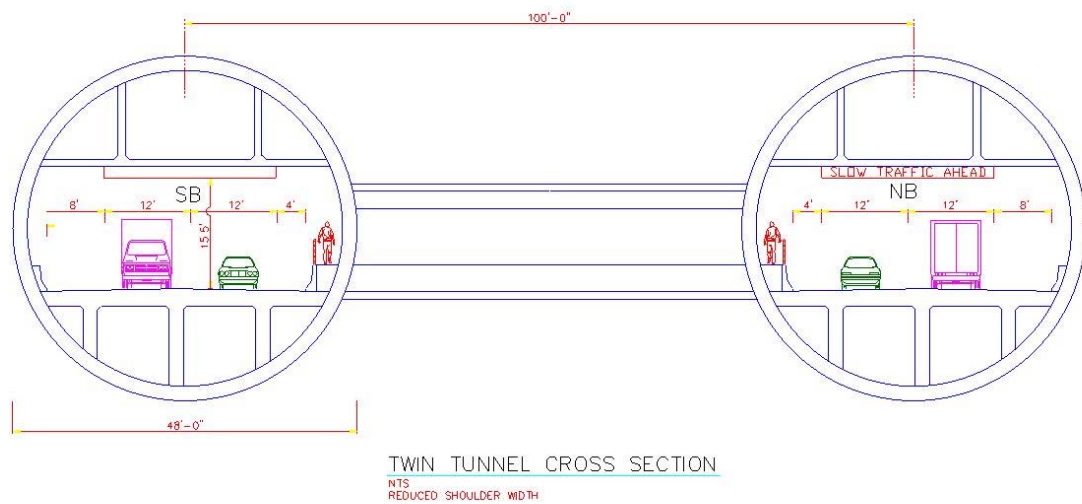

Figure 4.5. Twin Tunnel Cross Section

The second configuration considered is to stack the opposing traffic lanes one above the other in a single larger tunnel. Although this method has been used much less frequently, it does offer several notable advantages. By stacking the traffic lanes, the need for a mined cross passage is reduced to a much smaller and simpler to construct tunnel niche or cavern that is mined out on the side of the tunnel.

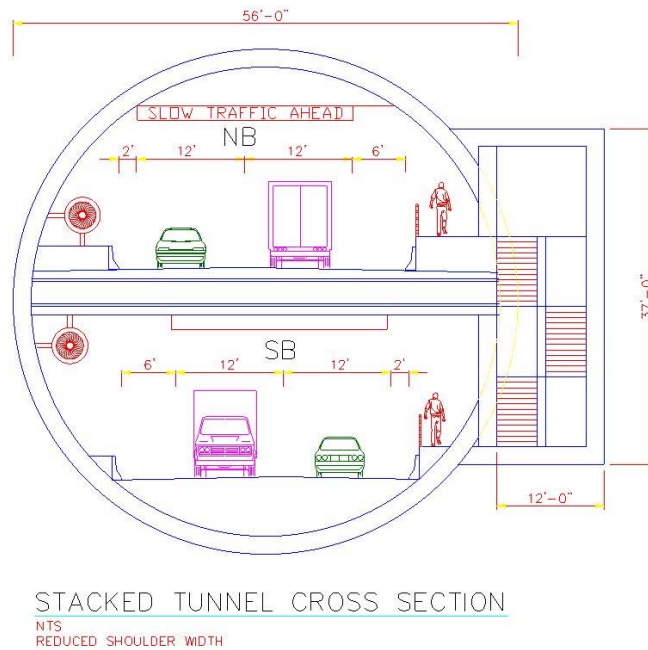

Figure 4.6. Stacked Tunnel Cross Section with Reduced Shoulders

Although the resulting stacked tunnel is larger than one of the twin tunnels, the net excavated material is more than 50 percent less and could result in significant cost savings. Unfortunately, the resulting stacked tunnel size is greater than the largest tunnel boring machine ever built. Conversations with some of the major TBM manufacturers indicate that the technology exists to produce such a machine. Because there is always significant risk in pioneering a tunnel of this type and size, it is recommended that a more traditional approach be considered.

In light of the anticipated large diameter of a Knik Arm tunnel, two approaches have been taken to bracket the size of the tunnel. The first allows for full design standard and the second for a highway cross section that has reduced shoulder widths and slightly reduced vertical clearance, as shown in the following table.

Table 4-2. Tunnel Design Components

Configuration (two lanes each direction.)	Lane Width (feet)	Outside Shoulder (feet)	Inside Shoulder (feet)	Egress Walkway (feet)	Vertical Clearance (feet)
Full Standard	12	8	6	3	16.4
Reduced Shoulder	12	6	2	3	15.5

The reason for considering a reduced shoulder width and reduced vertical clearance is to reduce the overall tunnel diameter, facilitate construction, and in turn, reduce the overall cost. In many locations in the United States and Europe, less than full-width shoulders are used and have been found to be acceptable. The primary difference in the resulting tunnel structure is the overall diameter. Although larger and larger tunnels have been constructed in the last 20 years, a tunnel that carries even a reduced shoulder cross section will require one of the largest tunnels built to date in the world.

Precast concrete tunnel liners assumed for the twin and stacked tunnels were 24 and 30 inches thick, respectively. The twin tunnels were assumed to be spaced at 100 feet on center to size the cross passages.

The reduced-shoulder, twin-bore section will be used for the purposes of costing the tunneling alternative. The extreme cost of tunneling warrants the use of minimum width shoulders and the stacked section relies on a large boring diameter that is beyond the scope of current technologies.

4.4.5 Alignment and Profile

The bore for a Knik Arm Crossing will have both horizontal and vertical alignment changes. **Figure 4.7** is a profile of the tunnel along the assumed length of 15,000 feet and aligns along the exact roadway alignment developed for the Hybrid Alignment A 2,000-foot-radius horizontal curve turns for a length of 4,000 feet to direct the roadway straight to Point MacKenzie. The vertical curvature simply aligns to a low point beneath Knik Arm by using grades that capture the most favorable subsurface tunneling materials.

Because within the boundary of Knik Arm, not including the approaches, the anticipated diameter of the tunnel will likely exceed the thickness of the silty clay layer along the alignment, the tunnel would be placed through or below the silty clay. This placement will require significant grades. Beginning at the Elmendorf side, the tunnel would descend at approximately three percent, before rising at approximately five percent on the Mat-Su Borough side of Knik Arm. The general geology along the alignment can be seen in **Figure 4.8**. Once additional geotechnical information is available, the tunnel alignment could be adjusted to provide the optimal location.

ELMENDORF AFB

NAT-SU BOROUGH

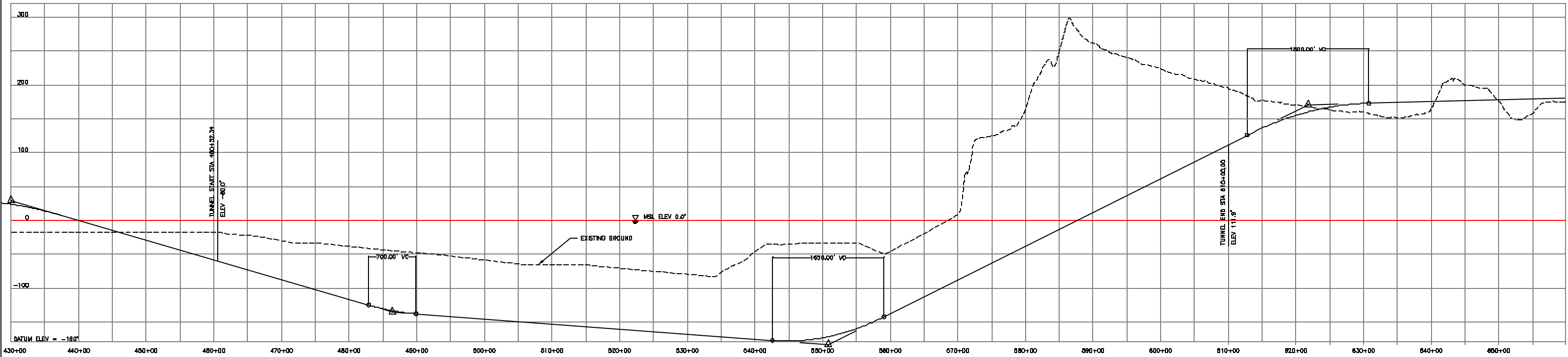

- NOTES:
1. VERTICAL ELEVATIONS BASED ON MUNICIPALITY OF ANCHORAGE DATUM
 2. ROAD ELEVATION PRIOR TO STATION 430+00 IS AT 20' ALONG TCE OF BLUFF
 3. ENTRANCE VERTICAL CURVE AT STATION 430+00 (NOT SHOWN) SHALL BE 1480' MINIMUM RADIUS

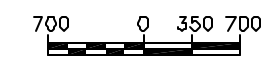

STATE OF ALASKA
 DEPARTMENT OF TRANSPORTATION
 AND
 PUBLIC FACILITIES
 KNIK ARM CROSSING
 ENGINEERING FEASIBILITY AND
 COST ESTIMATE UPDATE
 TUNNEL PROFILE
 FIGURE 4.7

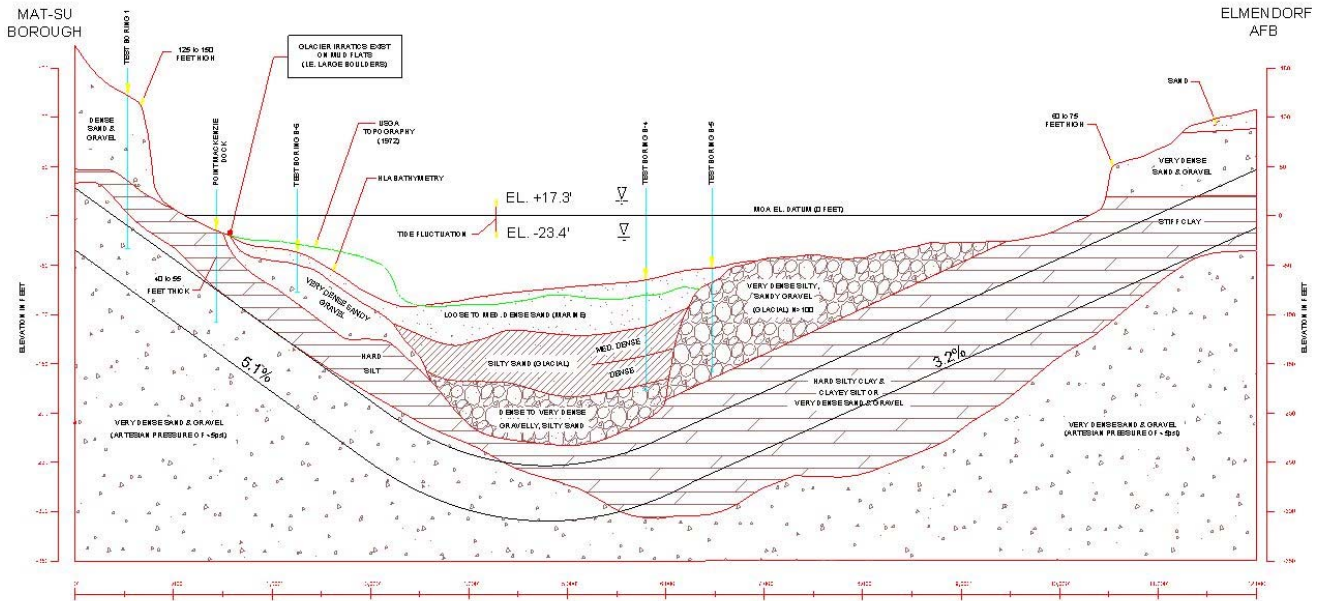

Figure 4.8. Tunnel Profile Through Geology

4.5 Tunnel Crossing Construction

4.5.1 Tunneling

Construction of a 48- to 56-foot tunnel below Knik Arm at the preferred location will likely encounter the soft-ground conditions typically shown in the profile. As indicated above, the clay soils are the most favorable to tunneling. These conditions, as discussed below, are much less than ideal and encroach on the existing state of knowledge in tunnel construction methods for the size of tunnel needed to provide the required number of traffic lanes, shoulders, and vertical clearance.

It is recommended that the tunnel be driven through or beneath the clay soils, assuming they are relatively continuous. Generally, a soft-ground, full-face tunneling machine with shield and probably a rotating cutter head would be selected for these clay materials. Because of the proximity of noncohesive soils and artesian conditions, either an EPBM or SPBM would be best suited for this type of excavation. Along this route, the tunnel would pass through the continuous hard clays below the channel bottom and surface through sands and gravels in both abutment approaches. To withstand the high water pressures (estimated at 7 bar) that could be encountered in the invert or crown of the tunnel during driving, the slurry or bentonite shield tunnel feature used extensively

overseas appears to be the most promising method.

The clay layer was selected to avoid or minimize cobbles and boulders present in the tills and other outwash deposits. Although this method appears to be favorably suitable, the following difficulties or potential problems affecting feasibility must be recognized:

1. The technology, although developed, has never before been used in Alaska, and although it has been used on several tunnel projects in the United States, it has never been used in the United States on a tunnel as large as that anticipated for the Knik Arm crossing. (It is a common method in Japan and Europe.) Communication, project coordination, scheduling, and efficiency may be less than ideal.
2. This tunneling method requires a relatively expensive tunneling machine compared to other conventional tunneling methods.
3. Tunneling will occur through glacial soils, and even the clays may contain glacial erratics or boulders. Therefore, provisions should be planned to remove obstructions, as encountered. It should be noted, however, that state-of-the-art slurry shields are equipped with rock crushers that have been shown to be effective in dealing with boulders.
4. Because the Hybrid Alignment is north of where the profile was developed, the clay thickness will probably be less and possibly discontinuous, forcing tunneling through tills where boulders will be experienced more frequently.

To evaluate tunnel-face behavior against collapse or stand-up time, the maximum total overburden pressure (about 16 tons-per-square-foot (tsf)) was compared with anticipated compressive strength (4 tsf), producing a ratio of overburden pressure to compressive strength of four. From a case history study of tunnels in soft ground, Peck (1969) showed that for clays, tunneling can be carried out without difficulty if the above ratio does not exceed five. If this ratio is exceeded, especially to values approaching seven, the material will likely invade the shield too fast and become unmanageable. On the basis of this relationship, it is assumed that the face should remain somewhat stable against squeezing and raveling. Although this consideration is less important with the slurry shield method, with sufficient stand-up time, it should be possible to enter the heading to remove or break up boulders, if necessary. Entrance to the heading could be necessary if an EPBM is used.

4.5.1.1 Bore

Tunneling operations could be staged from either side of Knik Arm but the Point MacKenzie side has a greater availability of staging areas. The assumed method of boring is a slurry/bentonite shield method with the use of a TBM that consists of a steel cylindrical hull with a full-face cutting wheel up front and a closed-face watertight bulkhead several feet behind the cutting wheel. A mud or bentonite slurry is pumped under pressure into and maintained in front of the watertight bulkhead to support the tunnel face by balancing the groundwater and earth pressures. A thin impervious mud cake forms at the earth slurry interface to restrain the face and house the pressurized

slurry (in this case, the clay would form its own slurry). Tunnel muck shaved from the face by the rotating cutter is mixed with the slurry and is discharged through hoses or pipes running through the tunnel and pumped to the surface for processing and muck removal. The slurry is reclaimed through a surface treatment facility and recirculated back into the tunneling operations. As the face is cut away and the cuttings are discharged, the mole is jacked forward, bearing against the tunnel lining being assembled in the tail piece of the shield. Tail packings or seals lie between the inside of the shield and the outside of the lining to prevent water or the pressurized mud fluid from entering the tunnel. A schematic of a slurry shield is shown in **Figure 4.9**.

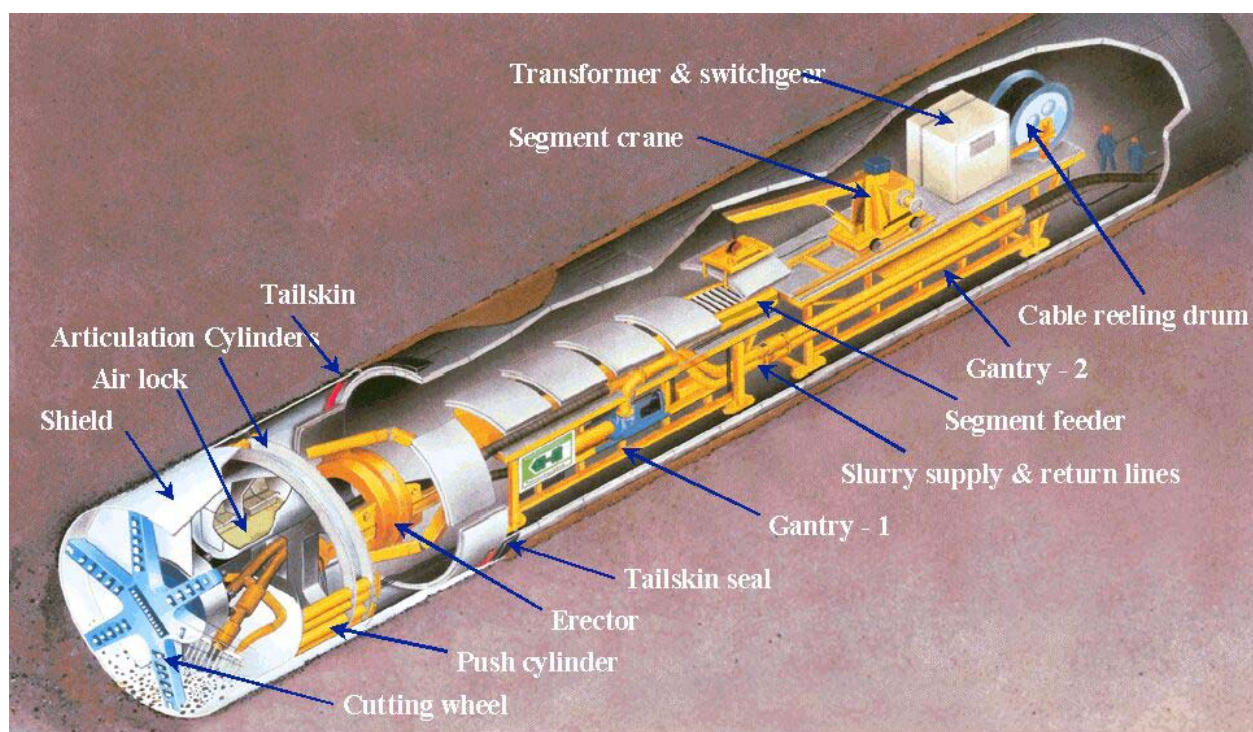

Figure 4.9. Tunnel Boring Machine—Slurry Shield Cut Away

To minimize settlement of the ground at the surface and nonuniform stresses on the liner, the annular space behind the lining is grouted with mortar or cement close behind the tail of the shield. A schematic representation showing the principle of the slurry or bentonite shield method is presented in **Figure 4.10**.

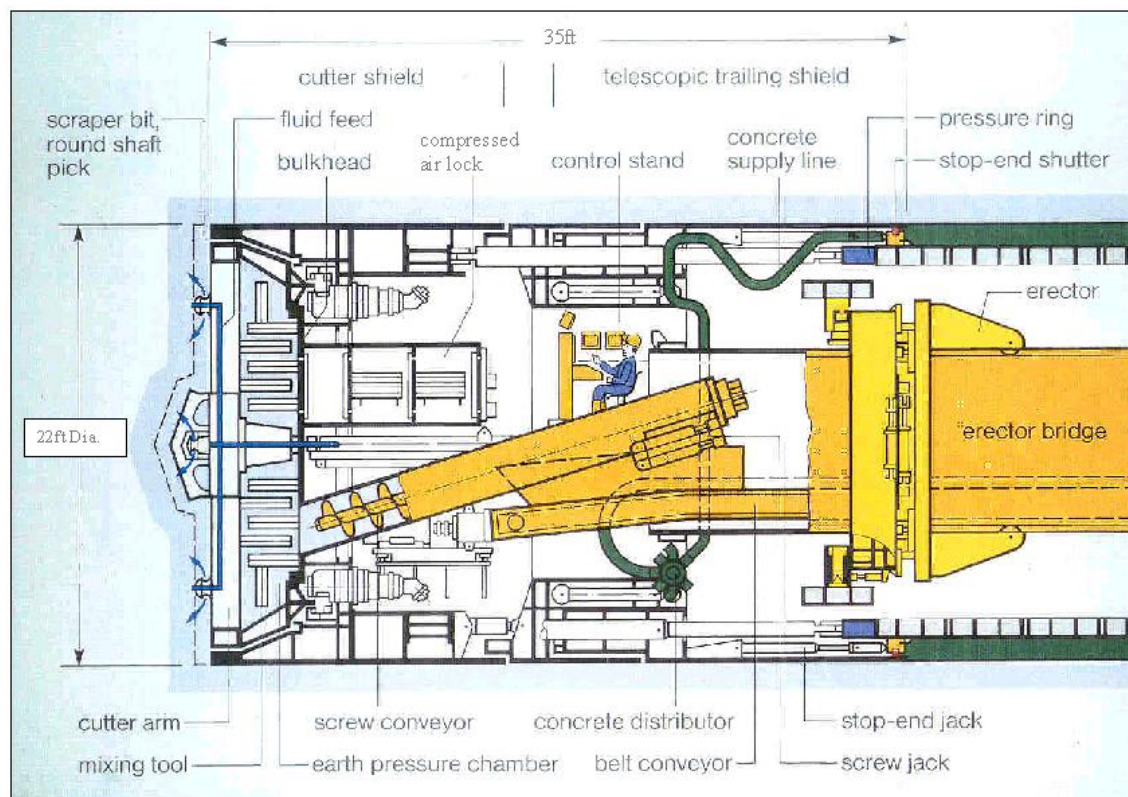

Figure 4.10. Slurry Pressure Boring Method

Specialized equipment is available to the various contractors for controlling and monitoring the entire construction operation and for solving many of the difficulties in carrying out this mechanized tunnel method. A certain expertise is required to evaluate the slurry fluid so that optimum slurry pressures can be maintained before and during the tunneling work. Also, because the face is driven blindly ahead, measurement procedures are available for determining the volume excavated for assessing the condition of the cutting area.

Specialized facilities are also available for handling, treating, and disposing of muck and slurry. Because of space limitations, contractors commonly use one of two types of surface treatment plants. For one plant, the slurry containing the muck is put through various processing units and discharged for disposal in a completely dehydrated cake form.

The other type of plant uses a similar surface treatment process involving settling tanks, vibrating screens and hydrocyclones to separate the coarser muck from the bentonite or clay. One difficulty with this method is the handling and disposal of gravel. Special gravel separators or crushers have been incorporated within the hydraulic system to remove the gravel at the tunnel level or to crush it and pump it to the surface for treatment with the rest of the muck. Also, some contractors are set up to replace the fluid in front of the bulkhead with compressed air for short periods of time to enable personnel

to enter this confined area to remove obstructions such as boulders or for maintenance work.

Finally, the design of the tail packing or seal is critical, because it must prevent slurry leakage as well as permit backfill grouting. One contractor has found that wire packings, especially wire brush packings, are more durable than those made of rubber. In other areas (Europe), it has been reported that thin steel plates are used for the packing material, instead of rubber in their bentonite shield.

The primary advantage of the slurry shield method is that it is a more mechanized method and compensates for the main shortcoming of the air-pressurized shield method; namely safety, greater work efficiency, and control. The use of air pressure is a valid method and still in use today in tunnels where overburden pressure on the tunnel face is less than 20 psi. In the Knik Arm crossing tunnel, pressures up to and possibly exceeding 40 psi will be encountered. Slurry shields offer one of the few ways to construct a tunnel in these conditions. From the team trip to Europe, it was learned that tunnels constructed in Europe have been advanced where face pressures of about 40 psi have been maintained to counterbalance groundwater pressure. In conversations with contractors performing this work, they expressed confidence in being able to handle conditions in these soils, recognizing that full hydrostatic pressures would not likely be encountered because of the very dense clay and till and that a much lower pressure would be effective in controlling face stability and water inflow.

4.5.1.2 Tunnel Support

The selection of a support system is largely dictated by the stand-up time available and the speed and method of mining. The lining of a tunnel excavated with a TBM must support high compressive forces from the ground and the shoving forces exerted by the TBM as it advances. Precast concrete segments incorporating gaskets for watertightness are used. The segments are typically either bolted together or held together with dowels. Grouting behind the liners to fill cavities is usually accomplished shortly after the liners are installed to minimize loosening of surrounding materials.

A tunnel will usually be built with a single liner system. A lining finish may be added later to facilitate ventilation airflow, light reflectivity, and support mechanical equipment.

In most soft ground tunnel designs the loads and thickness of tunnel liners are designed by using empirical procedures because the nature and magnitude of the movements and loads are closely related to the tunneling method, construction procedure, and workmanship. In general, a liner system should be capable of carrying all external soil pressures and water pressures imposed by the surrounding medium. It is anticipated that for the Knik Arm tunnel crossing, a 24-inch-thick, precast concrete liner would be sufficient. It is recommended that a double-gasketed liner system be employed and consideration be given to the use of hydro-swelling gaskets because of the subaqueous crossing in a seismically active region. Actual sources of pressures, distribution of ring loads, and swell forces can be estimated when actual tunneling conditions are better

defined with additional explorations.

4.5.2 Cross Passages

Cross passages allow vehicle occupants to access the adjacent tunnel or compartment of the tunnel in the event of a fire or other emergency as a means of egress and serve in lieu of an exit directly to the surface. To provide this access in the twin tunnel configuration, a cross passageway must be mined out between the tunnels. This removal of materials requires the breakout of the lining system installed with the tunnel that was bored by the TBM and special support placed to maintain the opening. Often steel liner segments and sets are used to stabilize the main tunnel and allow the excavation of the cross passage. The mining of the cross passageway is typically done by hand. The ground to be excavated is sequentially removed as support in the form of soil nails and shotcrete is applied. The approach will vary depending on ground condition and inflow of water and may require significant use of pregrouting before excavation to minimize the inflow of water. A cast-in-place concrete lining is typically added to this initial lining.

4.6 Cost Considerations

This section describes anticipated components of a tunnel that will affect cost considerations for a Knik Arm Crossing.

4.6.1 Concept Designs—Based on Bored Tunnels

Figures 4.11, 4.12, 4.13, and 4.14 depict working drawings that show the assumed equipment locations, spacing, control center, and maintenance facility footprints for the tunnel alternatives. The twin tunnel alternative was selected for the cost estimate.

4.6.1.1 Approaches

The south approach on the Anchorage side of Knik Arm will begin a downward three percent grade from a flat grade along the base of the bluff and at an elevation of 29 feet. The tunnel will begin at the approximate location where the top of the tunnel bore is 50 feet below the original ground surface. A wall or equivalent structure will need to be constructed to maintain the 29-foot elevation to prevent water from entering the tunnel opening. A water collection and pump station system would be constructed at the tunnel portal to prevent rainwater, snowmelt, or spills from entering the south portal.

The north approach will climb at a maximum five percent grade to daylight at elevation 150 feet in a deep roadway cut. A water collection and pump station system would be constructed at the tunnel portal to prevent rainwater, snowmelt, or spills from entering the north portal.

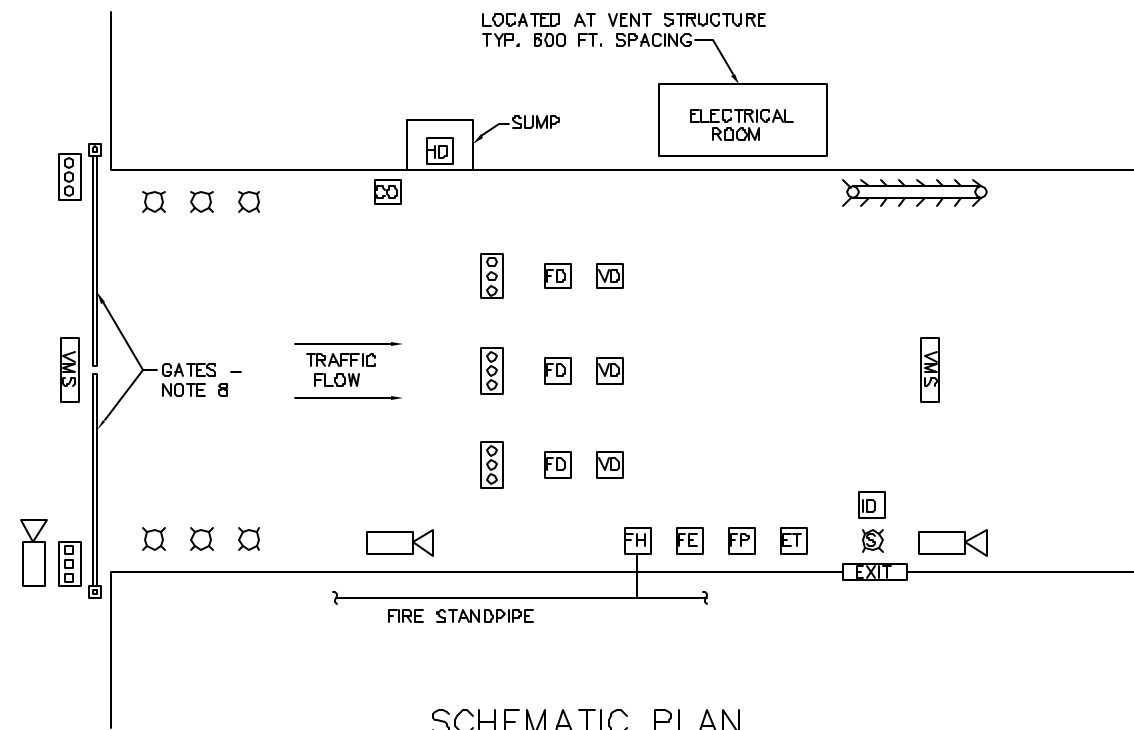

**SCHEMATIC PLAN
TYPICAL TUNNEL SECTION**
NTS

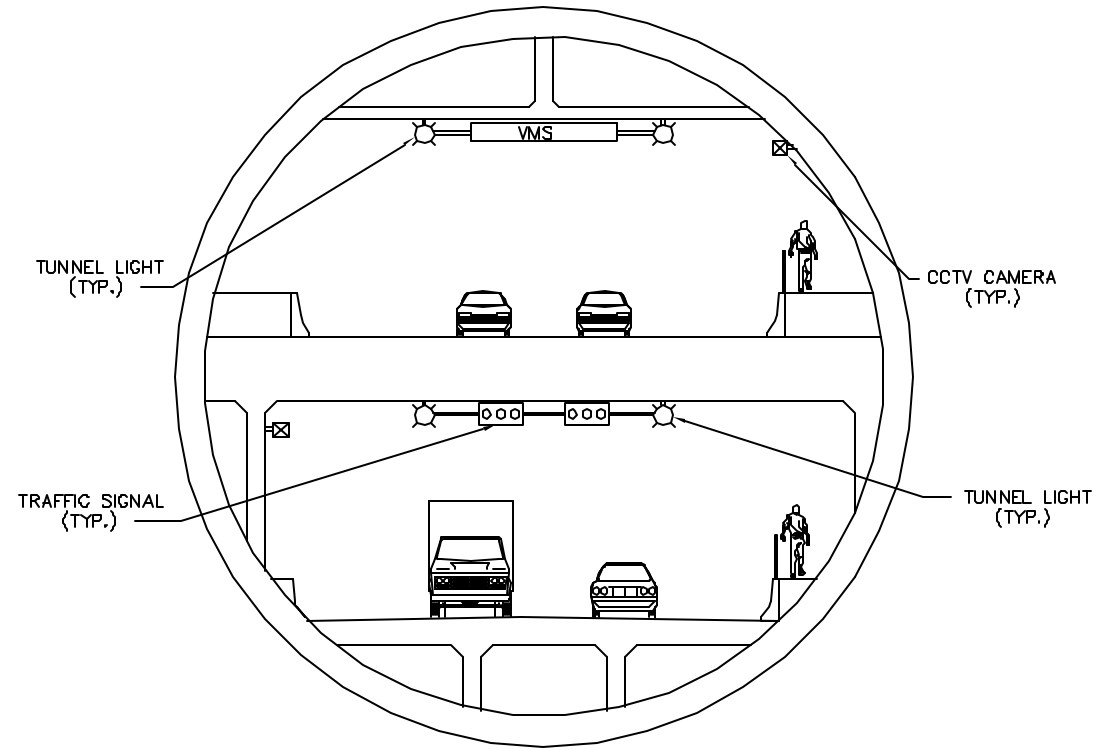

TYPICAL TRAFFIC SYSTEM SECTION
(NTS)

SYMBOL	EQUIPMENT	SPACING	NOTES
EXIT	EMERGENCY EXIT	600 FT	
ET	EMERGENCY CALL BOX	300 FT	
FP	FIRE PULL STATION	300 FT	ALSO LOCATE AT EXITS
FE	FIRE EXTINGUISHER	300 FT	
FH	FIRE HOSE STATION	300 FT	
VD	VEHICLE DETECTION	VARIES APPROX. 500 FT	
HD	HYDROCARBON DETECTOR	VARIES	LOCATE AT SUMPS
CO	CO DETECTOR	VARIES	
FD	FIRE DETECTOR	VARIES	IDENTIFY FIRE LOCATION WITHIN 50 FEET
ID	INTRUSION DETECTOR	VARIES	LOCATE AT CROSSPASSAGE, FIRE CABINETS
VMS	VARIABLE MESSAGE SIGN	1000 FT	ALSO LOCATE AT PORTALS APPROACHES
CCVT	CLOSED CIRCUIT TELEVISION	500 FT	ALSO LOCATE AT PORTALS APPROACHES
TS	TRAFFIC SIGNAL	1000 FT	ALSO LOCATE AT PORTALS APPROACHES
G	GATE	VARIES	LOCATE AT PORTALS
M	RAMP/MAINLINE METER STATION	VARIES	LOCATE AT PORTALS
LC	LEAKY COAX	CONTINUOUS	TUNNEL RADIO
TL	TUNNEL LIGHT	VARIES	INCLUDE APPROACH, THRESHOLD, TRANSITION LIGHTING
SL	STROBE LIGHT	EXITS	LOCATE AT CROSSPASSAGES
FS	FIRE SUPPRESSION	CONTINUOUS	WATER/FOAM - NOTE 8

GENERAL NOTES:

1. THIS SCHEMATIC PROVIDES GENERAL EQUIPMENT LAYOUT FOR TUNNEL FIRE SAFETY SYSTEMS.
2. EQUIPMENT CONTROLLER CABINETS ARE NOT SHOWN. THIS EQUIPMENT WILL BE HOUSED IN THE TUNNEL ELECTRICAL ROOMS.
3. TUNNEL VENTILATION IS NOT SHOWN. SEE MECHANICAL PLANS.
4. TUNNEL ELECTRICAL EQUIPMENT IS NOT SHOWN. SEE ELECTRICAL ONE LINE DIAGRAM.
5. INTELLIGENT TRAFFIC SYSTEMS (ITS) EQUIPMENT LOCATED OUTSIDE THE TUNNEL ARE NOT INCLUDED.
6. SEE MECHANICAL PLANS FOR FIRE SUPPRESSION SCHEMATIC.
7. SEE SHEET E703-1 FOR TUNNEL CONTROL CENTER AND INCIDENT RESPONSE FACILITIES.
8. GATES LOCATED AT PORTALS ARE FOR PLANNED FACILITY CLOSURES.

**PARSONS
BRINCKERHOFF**

STATE OF ALASKA
DEPARTMENT OF TRANSPORTATION
AND
PUBLIC FACILITIES

KNIK ARM CROSSING
ENGINEERING FEASIBILITY AND
COST ESTIMATE UPDATE
TUNNEL ALTERNATIVES
TUNNEL SYSTEMS SCHEMATIC
FIGURE 4.11

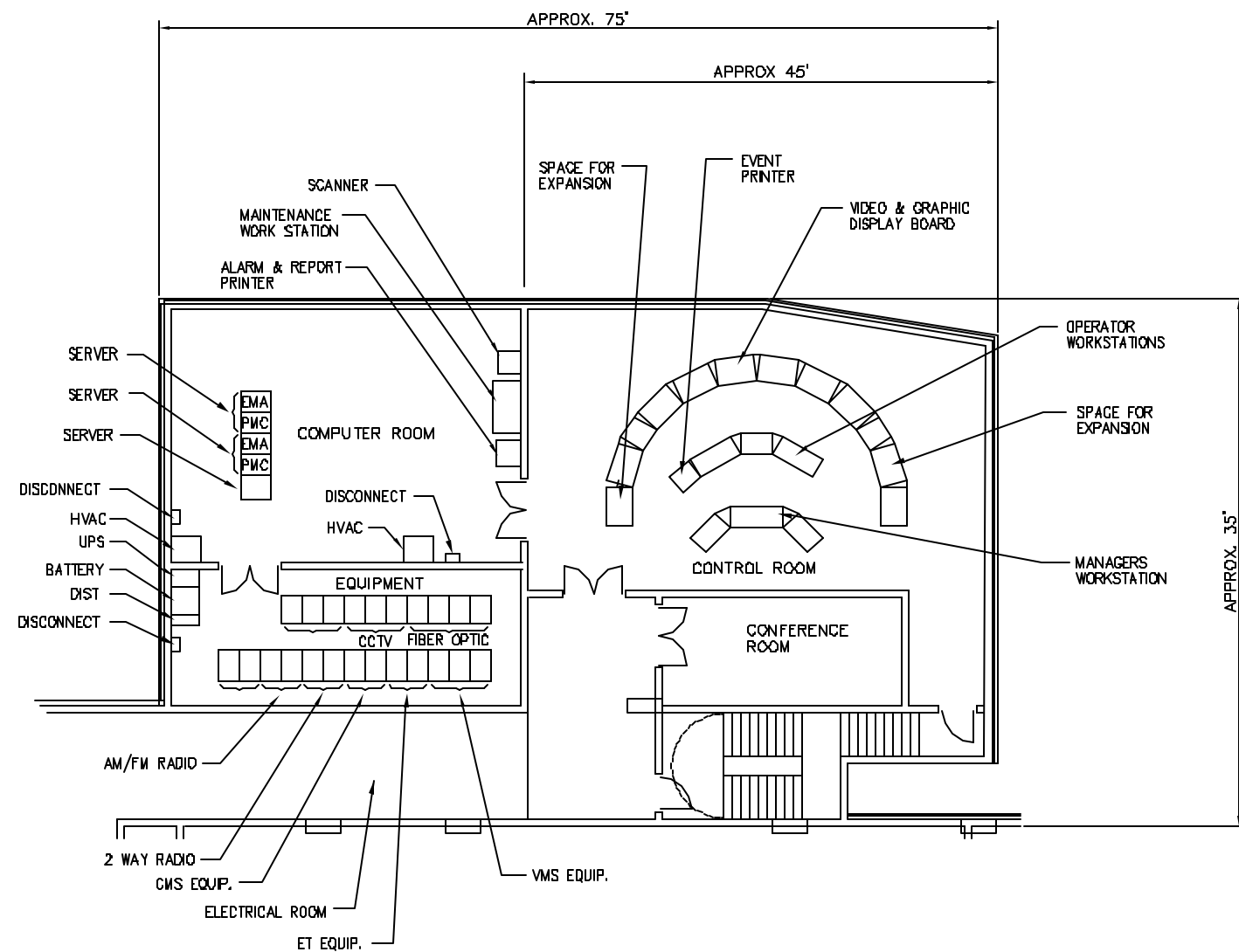

PLAN - LOCAL CONTROL CENTER
(NTS)

NOTES:

1. PLAN DEPICTS PROJECT REQUIREMENT FOR A LOCAL TUNNEL CONTROL CENTER (TCC) FACILITY.
2. THE PRIMARY FUNCTIONALITY OF THE LOCAL TCC IS MONITORING AND CONTROL OF TUNNEL TRAFFIC OPERATIONS.

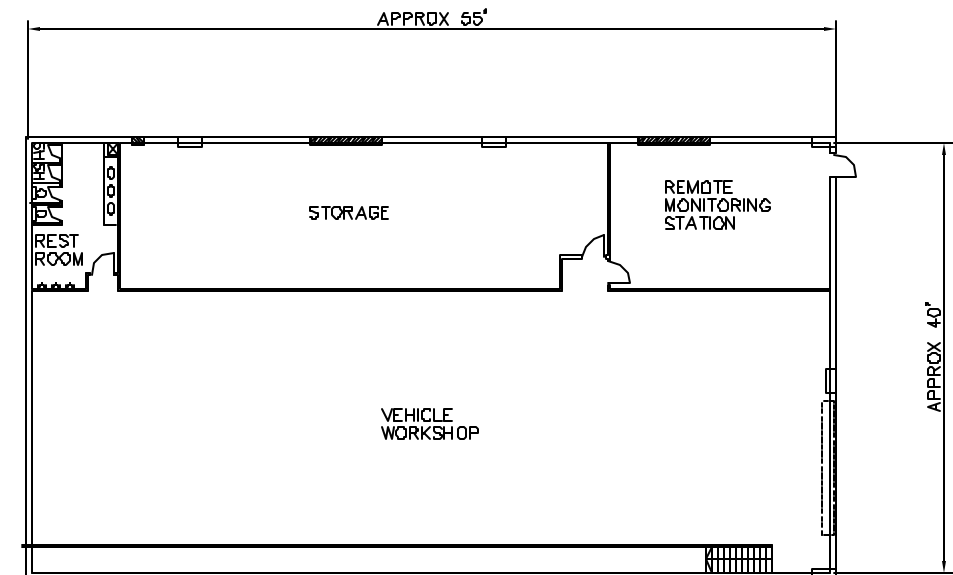

PLAN - INCIDENT RESPONSE FACILITY
(NTS)

NOTES:

1. PLAN DEPICTS PROJECT REQUIREMENT FOR LOCAL INCIDENT RESPONSE FACILITY.
2. THE PRIMARY FUNCTIONALITY OF THIS FACILITY IS TO HOUSE AN INCIDENT RESPONSE VEHICLE THAT PROVIDES A FIRST RESPONSE TO TUNNEL INCIDENTS SUCH AS VEHICLE BREAKDOWNS OR ROADSIDE DEBRIS.
3. FOR THE TUNNEL PLAN, TWO FACILITIES ARE REQUIRED:

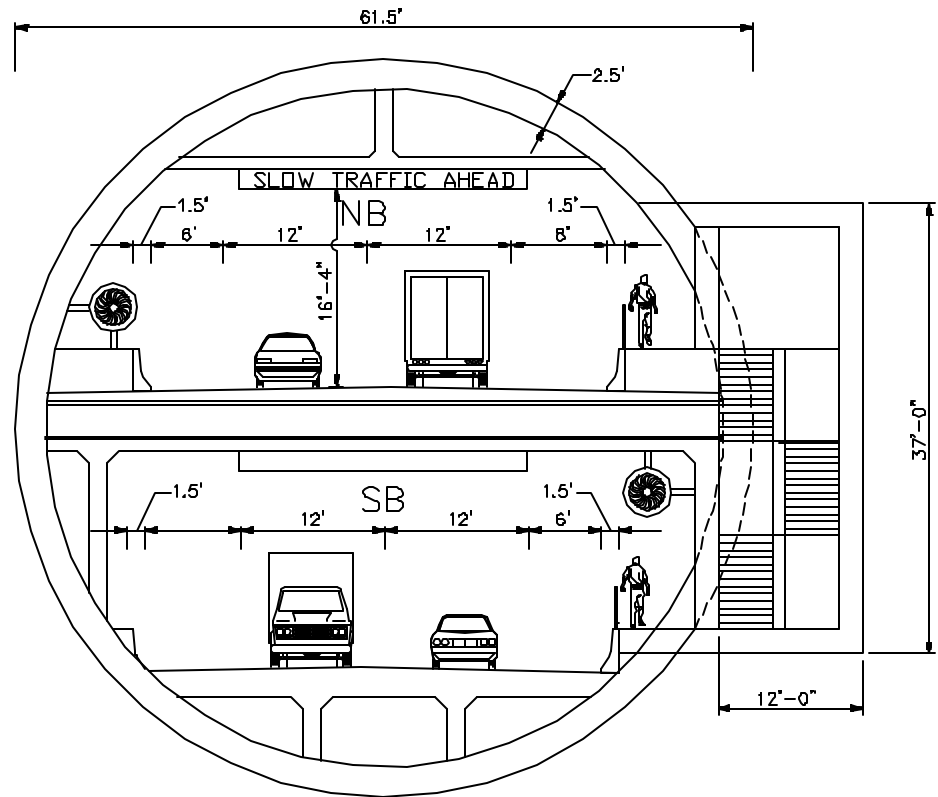

STACKED TUNNEL CROSS SECTION

NTS
PER ADOT STANDARDS

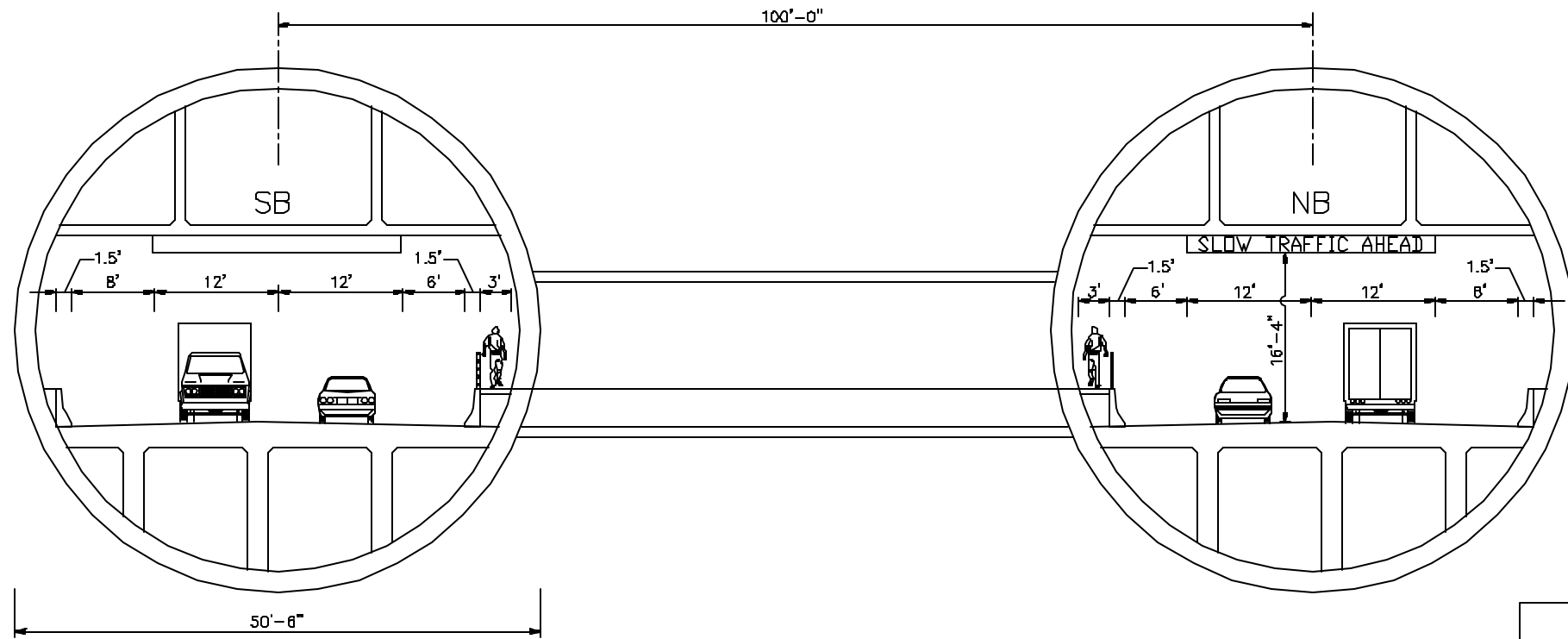

TWIN TUNNEL CROSS SECTION

NTS
PER ADOT STANDARDS



STATE OF ALASKA
DEPARTMENT OF TRANSPORTATION
AND
PUBLIC FACILITIES

KNIK ARM CROSSING
ENGINEERING FEASIBILITY AND
COST ESTIMATE UPDATE

STANDARD CROSS SECTIONS
FIGURE 4.13

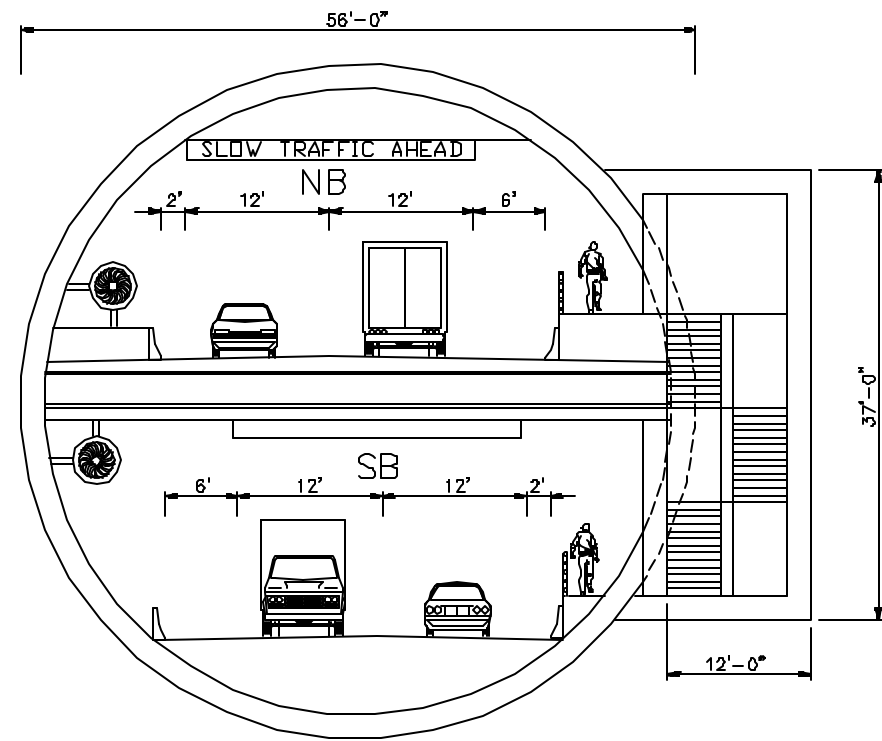

STACKED TUNNEL CROSS SECTION
 NTS
 REDUCED SHOULDER WIDTH

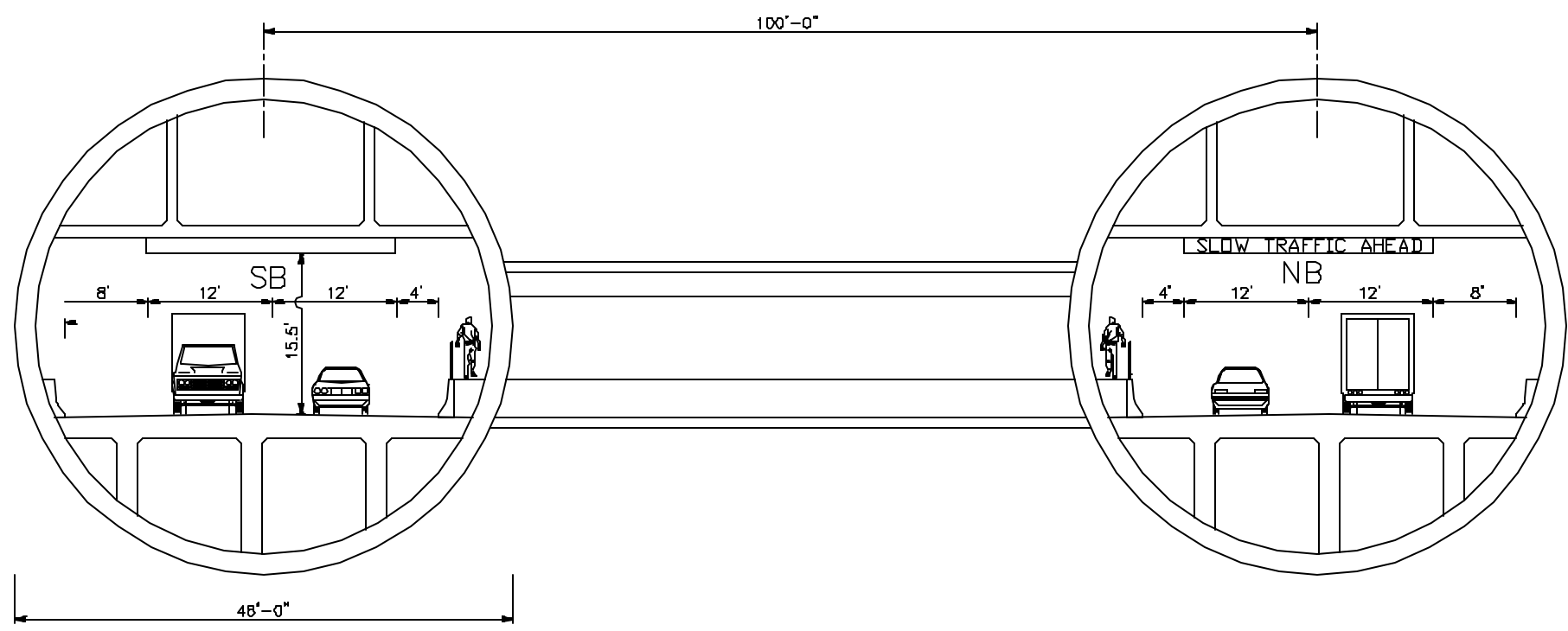

TWIN TUNNEL CROSS SECTION
 NTS
 REDUCED SHOULDER WIDTH

	STATE OF ALASKA DEPARTMENT OF TRANSPORTATION AND PUBLIC FACILITIES
	KNIK ARM CROSSING ENGINEERING FEASIBILITY AND COST ESTIMATE UPDATE
	REDUCED CROSS SECTION FIGURE 4.14

4.6.1.2 Cross Passages

The cross passage is typically approximately 10 to 12 feet in diameter but may be larger depending on space requirements for mechanical equipment. Cross passages are spaced 660 feet apart.

4.6.2 Primary Systems for Tunnel Ventilation

4.6.2.1 Conceptual Ventilation Design

Conceptual planning looked at the following combinations: (1) the stacked tunnel alternative—a single 14,000-foot tunnel with a cross section that has two stacked roadways incorporating two lanes per roadway; and (2) the twin tunnel alternative—two 14,000-foot twin tunnels with cross sections that have two-lane roadways. Both alternatives can be seen in the **Figure 4.15**.

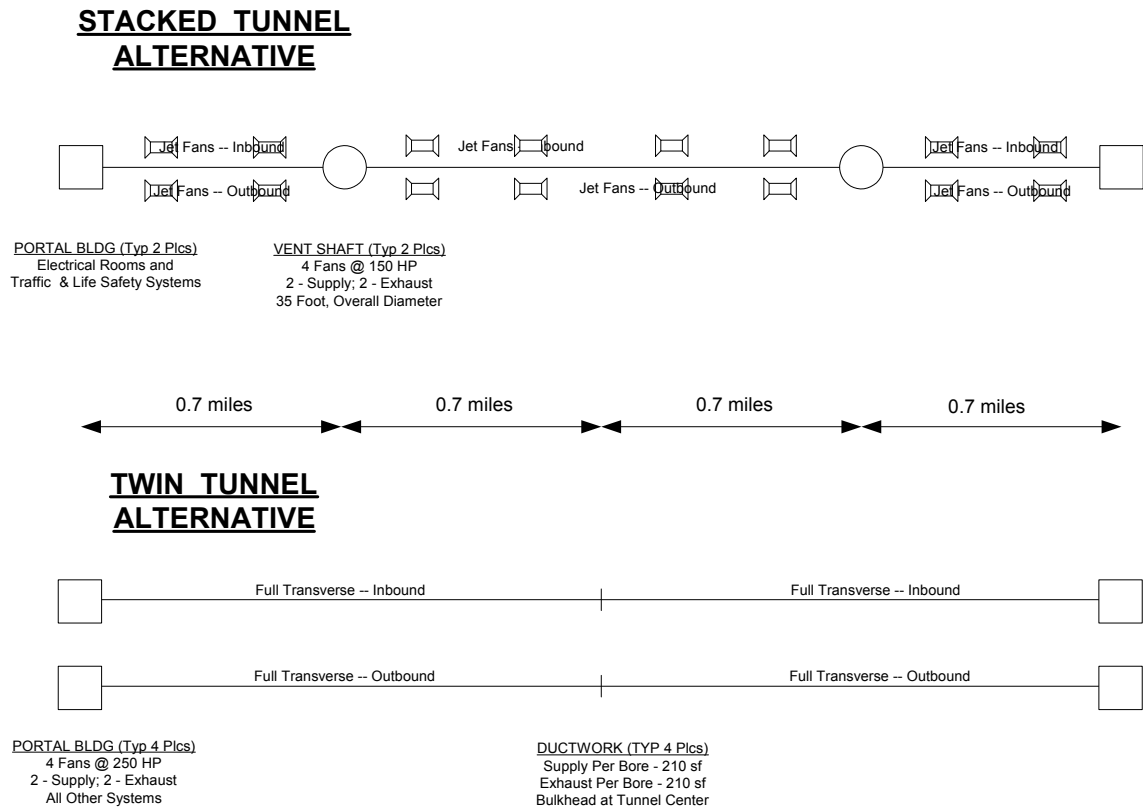

Figure 4.15. Schematic of Tunnel Alternatives, Ventilation Design

Stacked Tunnel Alternative

The ventilation system for the stacked tunnel alternative relies on a combination of mid-tunnel vent buildings and jet fans to extend ventilation the entire length of the 14,000-foot tunnel. There are four air intakes—two at tunnel portals and two at mid-tunnel. The two air intakes at mid-tunnel reduce the distance that the air must be transported along

the length of the tunnel, thereby minimizing structural requirements. Without the two mid-tunnel air intakes, 100 percent of the ventilation air would need to be exchanged at the portal buildings.

The four air intakes include the two portals and two mid-tunnel vent buildings. The mid-tunnel vent buildings are placed midway between the tunnel portal and tunnel midpoint. They include four fans in the headhouse at approximately 150 horsepower (HP) each and consist of two supply and two exhaust fans. The mid-tunnel ventilation shaft and connection to the tunnel can be seen in **Figure 4.16**.

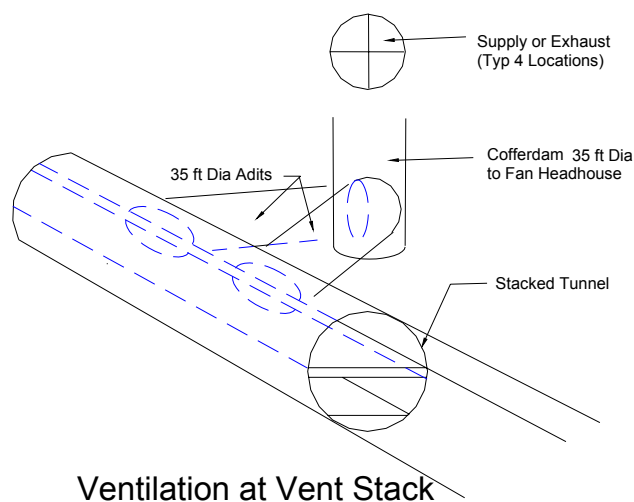

Figure 4.16. Mid-Tunnel Ventilation Shaft

The portal structures supply fresh air to the tunnel or exhaust vitiated air from the tunnel. This is accomplished by the longitudinal flow of the jet fans. Additional design is required to mitigate any pollution effects at the portals and to ensure ventilation air does not recirculate to the adjacent portal. This system operates during both normal and emergency operation.

Likewise, the mid-tunnel vent shafts exchange air with the tunnel by supplying fresh air to the tunnel or exhausting vitiated air from the tunnel. Additional design is required to determine the separation criteria so that ventilation air is not recirculated at mid-tunnel vent connections. The tunnel uses jet fans in lieu of ductwork because of structural constraints. The jet fans are more easily installed in shallow tunnel sections or along the sidewall as shown in the typical cross section of the tunnel. This system operates during both normal and emergency operation.

The location of the two mid-crossing vent shafts requires further investigation. The current location optimizes the distance between supply and exhaust air paths. It is

expected that these locations will be modified as a more optimal site is selected. Final selection should balance fan sizing and electrical and construction costs.

The ventilation system parameters for the stacked tunnel alternative are listed below:

- Longitudinal (jet fan) ventilation with mid-tunnel vent structures
- Estimated four axial supply and four axial exhaust fans for two mid-tunnel vent structures
- Estimated 16 jet fans per bore, with 32 jet fans total
- Estimated 2,800 HP or 2,100 kilowatt (KW) total

Twin Tunnel Alternative

The ventilation system for the twin tunnel alternative is a fully transverse system. The fully transverse system was selected because of the overall length of the tunnel and the ability to accommodate the necessary ductwork within the structural cross section for roadway, clearances, and ductwork.

The ventilation system for the twin tunnel alternative relies on portal fans located at the entrances to the tunnel to deliver uniform ventilation air along the length of the tunnel through supply and exhaust ductwork. The supply and exhaust ductwork is continuous throughout the tunnel and is fed by portal fans at both ends. The portal fans are sized to meet the ventilation requirements of approximately one-half the entire length of the tunnel.

There are two ventilation structures for each tunnel, with a total of four structures. Each portal structure includes four fans at approximately 250 HP each, consisting of two supply and two exhaust fans.

The ventilation system parameters for the twin tunnel alternative are listed below:

- Full-transverse ventilation with portal vent structures
- Estimated eight axial supply and eight axial exhaust fans
- Estimated 2,000 HP or 1,500 KW total
- Supply and exhaust ductwork at 420 square feet each (for single bore)

4.6.2.2 Additional Requirements

The following additional requirements for a ventilation system are noted:

- Ventilation of the tunnel is based on meeting acceptable levels for pollution in tunnels during normal and congested traffic operations. Normal traffic is free-flowing traffic at design speeds. Congested traffic is slow-moving (and stop-and-go) traffic typically considered at ten miles per hour (mph). Normal ventilation was based on pollution factors that resulted in a ventilation rate of approximately 30 cubic feet per minute per lane-foot. These factors are representative for planning purposes in the Northwest, specifically Seattle, Washington. Further investigation and traffic modeling are necessary to arrive at a more detailed estimate of pollution factors.

- Emergency ventilation is designed to assist in the evacuation or rescue, or both, of motorists from the affected tunnel bore.
- Two primary systems of ventilation were considered:
 - Longitudinal ventilation with jet fans
 - Full transverse ventilation
- Tunnel ventilation (mechanical systems) is typically not required in tunnels with minimum grades and tunnel lengths below 800 feet. The Government Hill cut-and-cover tunnel is not expected to require ventilation.

Longitudinal Ventilation with Jet Fans

Ventilation by this method prevents back-layering of smoke by producing a longitudinal velocity in the direction of traffic flow. This system applies to the stacked tunnel alternative.

Full Transverse Ventilation

Ventilation by this method creates a longitudinal airflow in the direction of traffic flow by operating the upstream ventilation in maximum supply and the downstream ventilation in maximum exhaust. This system applies to the twin tunnel alternative.

4.6.2.3 Ventilation Design Parameters

Fire Size

- The type and size of fire will dictate detection, surveillance, response scenarios, and key components of the ventilation system and possibly a suppression system. The fire design size has been assumed at 50 megawatts (MW). Further discussions with the fire department and other agencies charged with public safety are necessary to determine whether a preventive or prescriptive approach to life safety is warranted. Use of a preventive approach assumes that the agency will rigorously support programs to prevent hazardous cargoes from using the tunnel and will aggressively seek fines and court costs for violators. The prescriptive approach suggests that because of frequency and type of cargo anticipated, additional means and methods for life safety may be desirable.
- Representative fire heat-release rates that correspond to the various vehicle types are provided for guidance in the following table (from NFPA 502-19).

Table 4-3. Ventilation Design Parameters

Cause of Fire	Equiv Size of Gasoline Pool (ft²)	Fire Heat-Release Rate (MW)	Smoke Generation Rate (ft³/min)	Maximum Temperature (deg F)
Passenger Car	22	5	42	750
Bus/Truck	86	20	127	1290
Gasoline Tanker	323-1076	100	212-424	1830

Ventilation Air Requirements

- Outside air conditions: Portal area conditions include a minimum 15-mph wind and a minimum ambient CO concentration of 5 ppm (parts per million). These assumed conditions will affect overall air requirements and system sizing.
- Maximum CO concentrations in tunnels are based on U.S. Environmental Protection Agency and FHWA requirements. These requirements apply to tunnels located at or below an altitude of 5,000 feet. The following are allowable CO concentrations and exposure times:
 - Maximum 120 ppm for 15-minute exposure time
 - Maximum 65 ppm for 30-minute exposure time
 - Maximum 45 ppm for 45-minute exposure time
 - Maximum 35 ppm for 60-minute exposure time

The proposed ventilation designs for the tunnel alternatives are based on a maximum 120 ppm of CO in the tunnel with a maximum exposure time of 15 minutes. This assumed concentration is necessary to achieve reasonable costs for ventilation and ventilation structures.

To minimize ventilation costs, tunnel traffic operations will be constantly monitored and controlled. Portal signage will restrict lane use or stop traffic when delays are encountered. Message boards will post delays and advise motorists to shut down motor vehicle engines if necessary.

- Ventilation of the tunnel for tunnel workers is based on U.S. Occupational Safety and Health Administration (OSHA) requirements.
- Design conditions for emergency operations require a minimum velocity or “critical velocity” of air for smoke control. This velocity is determined from the methodology used by the U.S. Bureau of Mines that takes into account the buoyant effect of hot gases and longitudinal airflow and from modeling results from the FHWA MTVTP).
- The following are typical design parameters for air distribution systems:
 - Concrete ducts, plenums, and shafts—These components will have a nominal air velocity of 1,800 feet per minute (fpm) or less and a maximum air velocity of 2,200 fpm. Further analysis is necessary to determine economic trade-offs of first costs and operating costs, taking into account life safety and acoustic considerations.
 - Air outlets and intakes (normal operations)—For discharges near grade, the peak outflow air velocity will not exceed 500 fpm. For discharges eight feet or more above grade or away from public areas, the peak discharge velocity is typically limited by noise criteria. All discharge locations will satisfy air quality requirements. For outside air intakes eight feet or more above grade or away from public areas, the peak intake air velocity is typically below 1,200 fpm. For outside air intakes less than eight feet above grade, the peak intake air velocity will typically not exceed 1,000 fpm.
 - Air outlets and intakes (emergency operations)—For discharges near grade, the peak outflow air velocity is typically below 1,000 fpm. For

discharges eight feet or more above grade or away from public areas, the peak discharge velocity will be acceptable to local authority.

Equipment Sizing

Ventilation equipment sizing is based on the most stringent of the two conditions: (1) the rate required for acceptable levels of air pollution in the tunnel during congested traffic operations, and (2) the rate required for control of smoke and hot gases.

Noise Criteria

- The acoustical design will achieve acceptable sound levels for all activities and people involved. Because of the wide range of activities, acceptable outdoor levels will depend on local ambient sound conditions. Proper sound levels at various listener locations will be achieved by controlling the sound generation of the various sources, such as fans, and the sound transmission from the sources to the listeners.
- For sound sources inside the tunnel, the maximum noise level will be 86 decibels (acoustic) dBA (measured five feet above the roadway surface).

4.6.2.4 Ventilation Equipment Parameters

General

- The ventilation equipment will be heat resistant so that it is capable of operating under sustained fire exposure temperatures. Fans used during fire emergency will remain operational for a minimum of one hour in an airstream temperature of 482°F.
- Because the fan or group of fans closest to the fire site is likely to be rendered inoperable by the fire, additional fans will be included in the ventilation design.

Fan Types

- The fans for moving large quantities of air will be axial or centrifugal type.
- For noise sensitive areas, centrifugal fans, enclosed or plug type, will be considered.

Dampers and Single Point Extraction

- Consideration will be given to localized extraction of smoke and heat from fires. Dampers installed along tunnel ductwork will be designed for single point extraction.

Ductwork

- Ductwork, where required, will be integrated into tunnel structures.

4.6.2.5 Portal and Tunnel Crossing Structures

Air Distribution System Design

- Systems with localized ventilation structures will be designed to minimize ductwork and to promote efficient exchange of air with atmosphere.

Ventilation Shafts and Air Terminals at Grade

- Systems with ventilation shafts will be located to prevent discharge of fluids from entering the shaft
- Systems with ventilation shafts will be modeled to determined acceptable levels of environmental pollutants downstream of air discharge.
- Fresh air intakes will be typically ten feet above grade or will be set back from local roadway and sidewalk by a similar distance.
- Mid-tunnel vent shafts will be designed as in-water structures, taking into account the local environment and visual impacts of the tunnel location. Suitable protection will be provided against ice flows and high-water conditions. The vent shaft headhouse will house the fan rooms and support equipment. It will be compact while maintaining suitable access and working environment for inspections. Access is expected to be by land bridge, and equipment replacement will be by barge crane.

4.6.2.6 Ventilation Instrumentation and Control

System Safety

- The tunnel ventilation system will provide a high degree of reliability and flexibility for control of ventilation fans. The following elements are considered to be part of the ventilation system:
 - Equipment will be designed with safety interlocks that protect the equipment from high vibration and temperature that would otherwise affect its useful life. In the event of a fire, these interlocks will be removed, thereby placing a higher priority on the safety of motorists and pedestrians in the tunnel.
 - Equipment will have motor starters that will bring it online as soon as possible without affecting the power supply or creating unsatisfactory voltage drops. Motor starters may be of the variable frequency type, if necessary, to limit voltage drop and inrush current.

CO Monitoring System

- CO detectors will be provided as the prime indicator of tunnel air quality.
- Breather-tube sampling systems will be considered. This system will permit multiple samples from a central location for ease of maintenance and system calibration. The number of CO detectors will be based on the ventilation system design and the use of multiple units to avoid single-unit outages.

Electrical System

- Equipment will be designed to have redundant power supplies and transfer switches. This approach will allow the ventilation system equipment to operate in the event of a single loss of power from a substation feeder.
- Power reliability will be based on statistical measure of mean time between failures and ADOT&PF desired operating criteria.

Energy Conservation

- The ventilation design and location of fans and ventilation structures will be based on minimizing overall energy use.

4.6.2.7 Operations and Maintenance Centers

Local Control Room

- Tunnel systems will be controlled from a local site that permits local control, including operations and maintenance, to occur under direct supervision of the tunnel operator. The local site is typically responsible for training, reprogramming, adjustment, testing, repair, and replacement of systems and equipment.

Maintenance and Repair Centers

- Tunnel systems will require the resources for both maintenance services for minor repair as well as major component replacement.

4.6.3 Fire and Life Safety Systems

4.6.3.1 Fire Detection

General

Fire detection systems provide early detection and location of a fire situation within the tunnel. These systems may include fire alarm pull stations and automatic fire detectors.

Installation of fire detection systems will be in compliance with NFPA 72 National Fire Alarm Code and NFPA 502 Standard for Road Tunnels, Bridges and Other Limited Access Highways.

Manual Fire Detectors

Addressable, manual, fire alarm pull stations will be installed at intervals of not more than 300 feet.

Automatic Fire Detectors

- Linear heat detectors and spot detector devices may be used.

- Automatic fire detection systems will be capable of identifying the location of the fire within 50 feet.
- The automatic fire detection system within the tunnel is zoned to correspond with the tunnel ventilation zones.
- Ancillary spaces within tunnel facilities (mechanical and electrical rooms, cross passages, ventilation structures) will be supervised by automatic fire alarm systems.

Fire Alarm Control Panels

- Fire alarm control panels will be addressable type and will be Underwriter Laboratory (UL) listed for detection, suppression, or both (where applicable).
- Fire alarm zones will correspond to tunnel ventilation and fire suppression zones.
- Fire alarm control panels will report to a 24-hour monitoring facility.

4.6.3.2 Fire Suppression and Apparatus

General

Fire suppression and fire apparatus provide means to fight a fire within the tunnel. These systems may include fire extinguishers, standpipe systems, and sprinkler and foam systems.

Fire Extinguishers

- Portal fire extinguishers will be installed at intervals of not more than 300 feet.
- Maximum weight of fire extinguishers will be 20 pounds.
- Fire extinguishers will be based on NFPA 10 Standard for Portable Fire Extinguishers.

Standpipe Systems

- Tunnels will include a Class I standpipe system in accordance with NFPA 14 Standard for the Installation of Standpipe, Private Hydrant, and Hose Systems. Standpipe systems will also conform to the requirements of NFPA 502.
- Wet standpipe systems will be provided with suitable interconnection and bypass valve arrangements to allow the isolation and repair of any segment without impairing the operation of the remainder of the system.
- Flow rates will be based on the number of hoses required. The maximum flow rate will be 500 gallons per minute. The system capacity will be based on the design fire size.
- The standpipe system will drain to the tunnel drainage system. The drainage system will be capable of handling the maximum flow rate from the standpipe system.
- Each independent standpipe system will have a minimum of two fire department connections remotely located and separate from each other.

- Wet standpipe systems will be based on supplying the fire flow demand for a minimum of one hour.
- Dry standpipe systems will be based on delivering fire flow to all hose connections in ten minutes or less.
- Dry standpipe systems will have provisions for draining after use.
- Fire pumps will be designed to NFPA 20 Standard for the Installation of Stationary Pumps for Fire Protection.

4.6.3.3 Closed Circuit Television

General

- CCTV will provide the means for tunnel operators to view the tunnel from a local tunnel control center. This visual surveillance will provide several functions, including incident detection and verification and tunnel security.
- CCTV coverage areas will encompass all tunnel roadway areas, including tunnel emergency exits and will provide overlapping coverage areas for adjacent cameras so that the loss of one camera will not create a blind spot.
- CCTV coverage will also include all ramps and at-grade intersections adjacent to the tunnel entrances and portal areas.
- CCTV images will be viewed at the local tunnel control center locations. Video displays may employ quad-screen monitors and projection systems.
- Upon detection of a tunnel incident, the two nearest cameras will automatically provide coverage of that area and will begin recording the incident.
- Cameras will be positioned over the right shoulder area (slow lane) for ease of maintenance. Final spacing will be determined during final design. Spacing is expected to be in the range of 500 to 1,000 feet, depending on alignment and camera lens capabilities.

CCTV Equipment

- Camera features will include color, panning, tilting, zooming, and heavy-duty pressurized enclosures.
- Video recorders will be provided for recording incidents.

4.6.4 Tunnel Traffic Management Systems

4.6.4.1 General

- Tunnel traffic management for fire and life safety systems will include the ability to automatically detect tunnel incidents and to provide the operator with the necessary tools to manage and respond to these incidents.
- Tunnel traffic management systems will provide means to stop approaching traffic from entering the tunnel and its approaches in the event of a fire. Variable message signs (VMSs), other electronic signs, gates, and traffic signals will be located at the tunnel portal locations. The gates provide a physical barrier to deter vehicles from entering the tunnel(s) during a tunnel-closed scenario.

- TTMS will provide means to stop traffic upstream of a fire within the tunnel and to expedite vehicle flow downstream of the fire. VMSs and traffic signals will be located inside the tunnel.

4.6.4.2 Vehicle Detection

- Vehicle detection will provide the means to automatically detect vehicles and ultimately incidents within the tunnel. Quick detection and response to these scenarios will promote traffic flow and overall safety. Vehicle detector technologies may include induction-type loop detectors, video detectors, and radar.
- Detection systems will automatically detect and notify the operator of a tunnel incident and its location within 30 to 60 seconds of occurrence. The incident will be located to within 500 feet.
- Vehicle detection systems will provide the tunnel operators with additional information such as traffic volumes, vehicle speeds, and lane occupancy.

4.6.4.3 Variable Message Signs

- VMSs will be used to advise motorists of the nature of a tunnel incident and may also be used to post general traffic management messages. Messages can range from “Right Lane Closed Ahead” to “Tunnel Closed” and can include variable speed limit signing. The messages displayed will be part of a defined traffic plan selected by the tunnel operator at the control center.
- Final VMS size and locations assumes a two-line, 20-character VMS at tunnel approaches, portals, and ramps, and a one-line, 20-character VMS within the tunnel at intervals ranging from 1,000 to 2,000 feet. Sign character height is based on 18 inches. The overhead envelope allowed for these VMS signs is 24 inches.

4.6.4.4 Traffic Signals

- Traffic signals will be used to provide caution and stop indications for motorists in the event of an incident and for startup of traffic after tunnel closures. These devices will be used in conjunction with the VMSs.
- Traffic signals will be provided at 1,000-foot intervals within the tunnel and at tunnel portal locations. Traffic signals are expected to be 12 inches and employ light-emitting diode (LED) technologies.

4.6.4.5 Tunnel Communications

General

- Tunnel communication systems will be provided to allow for audio communications between motorists and tunnel operators in the event of a tunnel

incident or emergency. These systems typically will employ emergency telephones and radio rebroadcast and override systems.

- Tunnel communication systems will include tunnel radio coverage for maintenance and emergency staff.
- Tunnel communication systems will include the use of cellular telephone within the tunnel.

Emergency Telephones

- Emergency telephones will be provided within the tunnel at intervals of 300 feet maximum.
- Emergency telephones will be Americans with Disabilities Act (ADA) compliant in weather- and corrosion-resistant enclosures and will employ noise cancellation technologies to filter the background noise.

Radio Rebroadcast and Override Systems

- Radio rebroadcast and override technologies will be used to rebroadcast commercial radio stations and to override these commercial radio stations with emergency announcements from the tunnel control center during a tunnel incident.

Tunnel Radio

- Complete radio coverage of all roadway and ancillary facilities will be provided at the local emergency response (800 megahertz) band.
- These systems typically will be accomplished by a “radiax” or “leaky” type of coax cable routed linearly along the tunnel wall or walls.

Cellular Telephone

- Cellular telephone coverage will be provided within the tunnel.

4.6.4.6 Hydrocarbon Detection

General

- Detection of hydrocarbons at tunnel drainage storage tanks and pump stations will be provided. Detection will initiate both local and remote alarms.

4.6.4.7 Tunnel Security

General

- Tunnel security systems will provide additional deterrence against vandalism, theft, and terrorist attacks. Electronic security systems typically will include CCTV and access control systems. Additional security measures such as barriers, and the use of security personnel are not considered in this study.
- CCTV systems will be provided for visual surveillance. See Section 4.6.3.3.

- Intrusion and motion detectors will be provided at tunnel emergency exits and cross passages. They will notify the operator of intrusion into these areas.

4.6.4.8 Tunnel Hardware and Software Systems

General

- Tunnel hardware and software systems will provide the means to monitor and control the various tunnel systems ranging from plant management functions, such as ventilation, lighting, and power supplies, to traffic control systems, such as electronic signs and signals. These systems will employ both hardware and software architectures.
- The tunnel hardware and software system will be capable of initiating, operating, and monitoring the various tunnel modes associated with normal and emergency operations.
- Tunnel software will contain a “simulator” function that will allow ADOT&PF to test and train tunnel operators under simulated operating conditions.

4.6.5 Tunnel Lighting

4.6.5.1 General

- Tunnel lighting will provide motorists with adequate visibility to maintain traffic flow and to identify objects within the tunnel.
- Tunnel lighting levels and design will be based on ANSI/IES RP-22 American National Standard Practice for Tunnel Lighting.
- Tunnel lighting will include the installation of artificial light sources and their associated control systems for both daytime contrast lighting and nighttime interior lighting.
- Tunnel lighting will include emergency lighting backup systems.

4.6.5.2 Lighting Levels

- ANSI/IES RP-22 American National Standard Practice for Tunnel Lighting establishes four discrete tunnel lighting zones as illustrated in the following figure.

Figure 4.17
Tunnel Lighting Zones

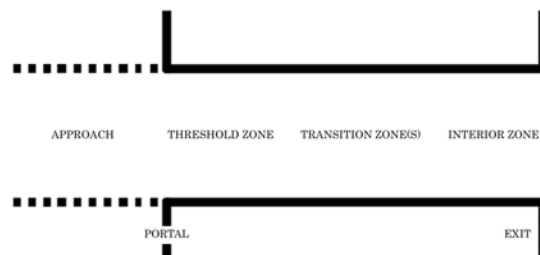

- Lighting levels for each zone will be based on several major factors, which are identified in the following table. These factors will be adjusted based on the preferred alternative.

Table 4-4. Tunnel Lighting Design Criteria

Design Factor	Value
Tunnel Approach Characteristic	Urban Tunnel
Tunnel Length	Up to 15,000 ft
Tunnel Orientation	North/South
Design Speed	55 mph
Roadway Surface	R1 Cement Concrete Pavement
Wall/Ceiling Reflectance	20%
Light Loss Factor	0.62

Approach Zone

- The approach zone is the section of roadway located immediately in front of the tunnel entry portal. The following design criteria have been established for the tunnel approach zone.

Table 4-5. Approach Zone Lighting Design Criteria

Design Factor	Value
Approach Zone Distance	530 ft
Average Pavement Luminance	0.9 cd/m ²
Luminance Uniformity Ratios	
L_{AVG}/L_{MIN}	3.0 to 1
L_{MAX}/L_{MIN}	5.0 to 1
Veiling Luminance Ratio (glare recommendation)	
Max Veiling Luminance/ L_{AVG}	0.3 to 1

Threshold Zone

- The threshold zone is the area inside the tunnel where a transition is made from the high natural lighting level outside the tunnel to the beginning of the transition zones. The following design criteria have been established for the tunnel threshold zone. These criteria are based on the table method identified in ANSI/IES RP-22. Lseq calculations for the threshold zone will be prepared upon selection of the preferred alternative.

Table 4-6. Threshold Zone Lighting Design Criteria

Design Factor	Value
Threshold Zone Distance	530 ft
Average Pavement Luminance (Northbound)	320 cd/m ²
Average Pavement Luminance (Southbound)	310 cd/m ²

Transition Zones

- The transition zones provide the stepped reduction in lighting levels as the driver proceeds from the bright threshold zone to the darker interior zones. Each reduction is determined by the adaptation rate of the human eye. It is currently envisioned that three transition zones will be provided. For planning purposes, it is expected that the cumulative length of the three transition zones will be in the neighborhood of 600 feet. The exact length of each transition zone will be established during final design. The following design criteria have been established for the tunnel transition zones.

Table 4-7. Transition Zone Lighting Design Criteria

Design Factor	Value
Transition Zone 1 Average Pavement Luminance	80 cd/m ²
Transition Zone 2 Average Pavement Luminance	40 cd/m ²
Transition Zone 3 Average Pavement Luminance	20 cd/m ²

Interior Zone

- The interior zone is the portion of the tunnel where the driver's vision has adapted to a low-luminance environment. The following design criteria have been established for the tunnel interior zone.

Table 4-8. Interior Zone Lighting Design Criteria

Design Factor	Value
Average Pavement Luminance	10 cd/m ²

Nighttime Luminance

- During nighttime, the motorist's eyes are adapted to low exterior luminance. The following design criteria have been established for the tunnel nighttime luminance.

Table 4-9. Nighttime Luminance Lighting Design Criteria

Design Factor	Value
Average Nighttime Pavement Luminance (entire tunnel)	2.5 cd/m ²

Wall Luminance

- Tunnel walls, up to ten feet above the roadway shoulder will have a minimum luminance of one-third of the average roadway level. Greater wall luminance may be required if a wall forms a major portion of a viewable background, such as the outer curve wall of a curved tunnel.

Uniformity Ratios

- Uniform luminance is necessary to ensure adequate adaptation to tunnel lighting levels. The following uniformity ratio design criteria have been established for tunnel lighting. These ratios are applicable to the roadway pavement and to the tunnel walls. Ratios for approach roadways are identified separately in the approach zone subsection above.

Table 4-10. Uniform Ratio Lighting Design Criteria

Design Factor	Value
L_{AVG}/L_{MIN}	2 to 1
L_{MAX}/L_{MIN}	3.5 to 1
Veiling Luminance Ratio (glare recommendation) $Max\ Veiling\ Luminance/L_{AVG}$	0.3 to 1

4.6.5.3 Light Sources

- The light sources under consideration were metal halide (MH), high pressure sodium (HPS), and induction lamps.
- MH lamps are an efficient, high-color-rendition white light source that is readily controllable. MH disadvantages are the relative nonuniformity of color, long restrike times, moderate high efficiency, and a shorter lamp life than for HPS lamps.
- HPS lamps are efficient, have long life characteristics, and are readily controllable. HPS disadvantages are its color, which peaks in the yellow portion of the visible spectrum, and the relatively long restrike time.
- Induction lamps are a new lamp technology with a white light source and an extraordinary 100,000-hour lamp life, which is four times that of HPS and five times that of MH. Disadvantages include high initial cost, large physical size, and a 150-watt limit in lamp size. Because this technology is new, fixture mockup and testing for a tunnel lighting application would be required.
- At this time, it is expected that tunnel lighting will employ HPS, MH, or a combination of HPS and MH.

4.6.5.4 Tunnel Luminaires

- Tunnel luminaires will be rated for installation in an arctic, corrosive environment and will be capable of withstanding periodic high-pressure washdown. The luminaires will also include tool-less entry, removable ballast and lamp holder, and quick-release electrical connections. Tunnel luminaires are typically stainless steel or aluminum (preanodized and powder coat finish) with sealed optical assembly and gasketing.
- Tunnel luminaires mounting hardware will be stainless steel and will resist or dampen vibration.

4.6.5.5 Lighting Controls

- Lighting controls will employ a luminance photometer and associated switching devices to adjust threshold and transition-zone lighting levels as ambient conditions change.
- Lighting controls interface with the tunnel hardware and software control system to allow operators to monitor and control lighting within the tunnel.

4.6.5.6 Emergency Lighting

- Emergency lighting to aid the egress of people and vehicles from the tunnel in the case of a power failure will be provided. These systems are expected to use uninterruptible power supply (UPS) and be wired separately from non-emergency circuits.
- Emergency exit lights and essential signs will also be powered by the emergency power supply, with no interruption of tunnel lighting for greater than 0.5 second.
- Emergency lighting levels for tunnel roadways and walkways are identified in NFPA 502, Standard for Road Tunnels, Bridges, and Other Limited Access Highways as 0.28 foot-candles, average luminance at the walking surface.

4.6.6 *Tunnel Electrical*

4.6.6.1 General

This section describes the provisions for the supply and distribution of electrical power to tunnel equipment to support both normal operations and life safety operations.

- The electrical systems will maintain ventilation, illumination, communications, traffic management systems, drainage, water supply, exits, exit routes, and remote annunciation and alarm under all operating and emergency conditions.
- Electrical installations will conform to NFPA 70, National Electrical Code, the National Electrical Safety Code, and local codes and standards.
- Electrical installation will conform to NFPA 502, Standard for Road Tunnels, Bridges, and Other Limited Access Highways.

4.6.6.2 Electrical Loads

As a first step in electrical design, assumptions are made about the various electrical loads. The electrical loads listed below assume a 15,000 foot-long tunnel with a cross section that has two bores and two lanes per bore.

- Tunnel ventilation—range from 1,000 kilovolt-amperes (KVA) to 3,600 KVA
- Tunnel lighting—range from 1,500 KVA to 2,000 KVA. Estimate is based on lighting levels and typical tunnel fixture layout for each lighting zone.
- Tunnel service buildings—range from 150 KVA to 225 KVA, assuming 15,000 square feet at 10 to 15 watts per square foot

- Tunnel drainage—range from 350 KVA to 600 KVA, assuming 10 to 15 50-HP pumps
- Miscellaneous loads—approximately 700 KVA, assuming 0.5 watt per square foot
- Total—range from 3,700 KVA to 7,125 KVA; estimated to be 4 MW to 7 MW of connected load

4.6.6.3 Electrical Supply

- A primary three-phase source of electrical power service is assumed to be available.
- A separate secondary three-phase source of electrical power service will be required. Alternative service is required according to NFPA 502, Standard for Road Tunnels, Bridges, and Other Limited Access Highways.

4.6.6.4 Electrical Supply Reliability

- Both primary and secondary electrical supplies are assumed to be available and highly reliable
- It is assumed that electrical generators will be used and conform to NFPA 10, Standard for Emergency and Standby Power Systems.

4.6.6.5 Electrical Power Distribution

- The primary and secondary electrical supplies for the tunnel will provide maximum reliability of the power supplies. Cabling associated with the two supplies will be segregated to achieve maximum reliability. Tunnel equipment will be wired so that a single event or fire produces minimum effect on the operation of the overall system.
- The primary and secondary supplies can be provided at opposite ends of the tunnel, at one end of the tunnel, or at central locations. This situation applies to the Government Hill cut-and-cover tunnel.
- For a longer tunnel crossing (the main Knik Arm Crossing), the high-voltage feeders will run the entire length of the tunnel. Substations will be tapped at various points to serve the 480-volt loads. Automatic switchover facilities would be included at the 480-volt level.

4.6.6.6 Electrical Materials and Equipment

- Electrical materials and equipment will be rated for installation in a moist corrosive environment. Equipment cabinets and enclosures installed in the tunnel will be stainless steel.
- Electrical materials manufactured for use as conduits, raceways, ducts, cabinets, and enclosures will be capable of being subjected to temperatures of 600°F for one hour without supporting combustion and loss of structural integrity.

- Electrical systems installed within confined spaces will not use materials that produce toxic byproducts during electric circuit failure or when subjected to fire.
- Polyvinyl chloride (PVC) conduits, wire ways, and vinyl-insulated and jacketed conductors or cables will not be used in tunnels, ducts, plenums, and other enclosed spaces.
- All conductors will be completely enclosed in armor sheaths, conduits, or enclosed raceways, boxes, and cabinets. Conductors will not be installed in an exposed manner and will not be surface mounted in air plenums that can carry air at elevated temperatures in a fire emergency.

4.6.6.7 Emergency Power

- A UPS system will be provided for essential tunnel loads in the event of a main electrical supply failure. Essential tunnel loads include lighting, fire protection, communications, alarm, and traffic control systems.
- The project will need to evaluate the reliability of the electric system to support large loads such as ventilation and drainage pumps in the event of a power failure. For estimating purposes, it is assumed that standby generating equipment is required.

4.7 Conclusions

For purposes of cost estimating, it is assumed that the tunnel will be driven through or beneath the clay soils, assuming they are relatively continuous. Generally, a soft-ground, full-face tunneling machine with shield and probably a rotating cutter head would be selected for these clay materials. Because of the proximity of noncohesive soils and artesian conditions, either an EPBM or SPBM would be best suited for this type of excavation. Along the Hybrid Alignment route, the tunnel would pass through the continuous hard clays below the channel bottom and surface through sands and gravels in both abutment approaches. To withstand the high water pressures that could be encountered in the invert or crown of the tunnel during driving, the slurry or bentonite shield feature used extensively in tunnels overseas appears to be the most promising method.

5.0 REFERENCES

- Alaska Department of Highways, December 1970, Report of Preliminary Field and Laboratory Soils Data, Knik Arm, Project No. X12750.
- Alaska Department of Transportation and U.S. Department of Transportation, Federal Highway Administration, August 31, 1984, Knik Arm Crossing, Draft Environmental Impact Statement and Section 4(f) Evaluation, Anchorage, Alaska, FHWA-AK-EIS-84-01-D.
- Alaska Department of Transportation and Public Facilities, 2002a, Hybrid Corridor Bridge Crossing Opinion of Cost.
- Alaska Department of Transportation and Public Facilities, 2002b, Knik Arm Crossing Foundation Update Memorandum.
- American Association of State Highway and Transportation Officials, 2002.
- American Petroleum Institute, 1993, Recommended Practice for Planning, Designing and Constructing Fixed Offshore Platforms, Washington, DC.
- Burgess, Christopher J., Cold Weather Cast-in-Place Segmental Construction of Long Span Bridges, TRB 00-1155, Transportation Research Board.
- Confederation Bridge, 2002, <http://www.confederationbridge.com>.
- Dames & Moore, December 1970, Report of Seismic Reflection Survey, Proposed Knik Arm Highway Crossing, prepared for the Alaska Department of Highways.
- Golder Associates, January 1990, Port of Anchorage, Parcel A and EE, Site Development, Geotechnical Investigation.
- Harding Lawson Associates, November 1984, Geologic and Geotechnical Considerations, Knik Arm Crossing, Anchorage, Alaska, HLA Job No. 9620,016.08.
- Howard, Needles, Tammen & Bergendoff, 1972, Basic Research, Analysis & Exploratory Investigations, Knik Arm Highway Crossing, Anchorage, Alaska, prepared for the Alaska Department of Highways.
- International Conference of Building Officials, 1997, Uniform Building Code.
- Lachel & Associates et al., April 2002, Matanuska-Susitna Borough, Port MacKenzie Dock Facility, Independent Geotechnical and Marine Engineering Evaluation.
- Lohrmann, Atle, and Blair Brumley, 1992, Acoustic Doppler and Backscatter Data Collected with a Broadband Acoustic Doppler Current Profiler (BBADCP) for the Upper Cook Inlet Field Data Project During the Period July 12-22, 1992.
- National Earthquake Hazard Reduction Program, 2000, Building Seismic Safety Council.
- National Oceanic and Atmospheric Administration, National Ocean Service, 1996, Tide Tables 1997 High and Low Water Predictions, West Coast of North and South America, Including the Hawaiian Islands.

- National Oceanic and Atmospheric Administration, National Ocean Service, 2002, <http://www.co-ops.nos.noaa.gov/>.
- Sarpkaya, Turgut, and Michael Isaacson, 1981, Mechanics of Wave Forces on Offshore Structures.
- Schlaich, J., and H. Scheef, 1982, Concrete Box-Girder Bridge, International Association for Bridge and Structural Engineering.
- Seed, H.B., K.O. Cetin, R.E.S. Moss, A.M. Kammerer, J. Wu, J.M. Pestana, and M.F. Riemer, 2001, "Recent Advances in Soil Liquefaction Engineering and Seismic Site Response Evaluation," Fourth International Conference on Recent Advances in Geotechnical Earthquake Engineering and Soil Dynamics, No. SPL-2, <http://nisee.berkeley.edu/library/seed/>.
- Shannon & Wilson, Inc., August 1964, Anchorage Area Soil Studies to U.S. Army Engineer District, Anchorage, Alaska.
- Shannon & Wilson, Inc., August 1971, Geologic and Engineering Reconnaissance, Proposed Knik Arm Crossing, Anchorage, Alaska.
- Shannon & Wilson, Inc., October 1994, Geotechnical Report, Ingra Street Extension, Anchorage, Alaska.
- Shannon & Wilson, Inc., March 1997, Site Characterization, Defense Fuel Support Point -Anchorage, Volume I.
- Shannon & Wilson, Inc., 1997, Geotechnical Report, Transit Yard "E" Development Project, Port of Anchorage, Anchorage, Alaska, May
- Shannon & Wilson, March 2001a, Foundation Recommendation Report and Ground Motion Studies, Copper River Highway, Million Dollar Bridge.
- Shannon & Wilson, Inc., February 2001b, Ingra/Gambell Street Rail Overpass, Anchorage, Alaska.
- Shannon & Wilson, Inc., October 2002, Field Logs from Drilling Near Port MacKenzie Dock.
- U.S. Army Corps of Engineers, Engineer Research and Development Center, February 2002, Engineering Evaluation of Port MacKenzie Dock Facility, Anchorage, Alaska.
- U.S. Federal Highway Administration, 2001, "Evaluating Scour at Highway Bridges," Hydrologic Engineering Circular No.18, Fourth Edition.
- U.S. Federal Highway Administration and Alaska Department of Transportation and Public Facilities, 1983a, "Design Concepts and Cost, Corridor Alternatives Analysis," Knik Arm Crossing Technical Memorandum No. 8.
- U.S. Federal Highway Administration and Alaska Department of Transportation and Public Facilities, 1983b, "Marine Navigation," Knik Arm Crossing Technical Memorandum No. 18.
- USKH, February 1990, Port of Anchorage, Land Development Project, Phase I-Design Analysis Report, Anchorage, Alaska.

Wesson, Robert L., Arthur D. Frankel, Charles S. Mueller, and Stephen C. Harmsen, 1999, Probabilistic Seismic Hazard Maps of Alaska U.S. Geological Survey Open-File Report 99-36, <http://geohazards.cr.usgs.gov/eq/>.

Woodward-Clyde Consultants, June 1983, Final Report on Port of Anchorage, Anchorage, Alaska.

Woodward-Clyde Consultants, 1987, Geotechnical Investigation, Anchorage Courthouse Addition, Anchorage, Alaska, final report.

#1 Knik Arm Crossing Basic Research, Analysis & Exploratory Investigations.

#16 Additional Geophysical Survey Data, Point MacKenzie/Point Woronzof.

1983-2001, #36 Long Range Transportation Plan, Anchorage Bowl.

#20 USGS Documents re: Sedimentation Patterns.

#33 New Devices For Harnessing Ultra Low Head Hydropower.

#46 Major Corridors Study, Scoping Document.

#47 HRIS Selection: Innovative Public Financing Tech: Value Capture/Joint Dev.

#51 Knik Arm Crossing: Economic Impact on Anchorage.

#52 Geo-rezoning, Eagle River-Chugach-Eklutna.

#54 Major Corridors Study, Scoping Summary.

#74 Phase 1 Feasibility Study for a Proposed Knik Arm Crossing Utilizing a Ferry.

1984, #50 Point MacKenzie, Area Meriting Special Attention.

April 13, 1982, #8 Knik Arm Crossing Project Work Task Plan.

April 15, 1983, Economic Feasibility.

April 1981, Preliminary Assessment of Cook Inlet Tidal Power.

August 12, 1983, "Benefit-Cost Analysis Corridor Alternatives Analysis," Technical Memorandum No. 11.

August 12, 1983, "Environmental Impact Corridor Alternatives Analysis," Technical Memorandum No. 10.

August 12, 1983, "Financing Corridor Alternatives Analysis," Technical Memorandum No. 13.

August 12, 1983, "Travel Forecasts Corridor Alternatives Analysis," Technical Memorandum No. 9.

August 12, 1983, "Urban Growth Forecasts Corridor Alternatives Analysis," Technical Memorandum No. 7.

August 12, 1983, Benefit-Cost Analysis Corridor Alternatives Analysis, Technical Memorandum No. 11. .

- December 1, 1983, "Cost-Effectiveness Corridor Alternatives Analysis," Technical Memorandum No. 12.
- December 1955, #76 Preliminary Appraisal of Proposed Knik Arm Causeway.
- December 1970, Engineering Geology & Foundation Report.
- December 1970, Report of Seismic Reflection Survey.
- December 1981, #5 Proposal for Project A81021, Knik Arm Crossing, Volume I, Management.
- December 1981, #6 Proposal for Project A81021, Knik Arm Crossing, Volume II, Planning & Engineering.
- December 20, 1983, "Marine Biological Studies," Technical Memorandum No. 15.
- December 5, 1983, Final Corridor Alternatives Analysis.
- February 1983, "Corridor Evaluation Methodology," Technical Memorandum No. 1.
- February 1983, "Marine Seismic Reflection Survey," Technical Memorandum No. 2.
- February 1986, Corridor Analysis for the Proposed Knik Arm Crossing, Elmendorf Air Force Base/Fort Richardson.
- February 28, 1985, Implementation Options, Volumes 1 and 2.
- January 11, 1985, "Marine Navigation," Technical Memorandum No. 18.
- January 1968, #22 Turnagain Arm Crossing Financial Studies.
- January 27, 1984, "Freshwater & Terrestrial Habitat Studies," Technical Memorandum No. 16.
- January 27, 1984, "Survey of Archeological and Historic Resources," Technical Memorandum No. 17.
- January 30, 1981, Knik Arm Wetlands Study.
- July 1984, #55 Knik Arm Railroad Crossing Feasibility Study.
- March 1, 1985, "Biological Secondary Impact Analysis," Technical Memorandum No. 20.
- March 1, 1985, "Land Value Analysis Implementation Options," Technical Memorandum No. 19.
- March 1, 1985, Land Value Analysis Implementation Options, Technical Memorandum No. 19. .
- March 1982, #23 AMATS Major Corridors Study.
- March 1984, #48 Matanuska-Susitna Borough Trails System, Draft.
- March 1984, #49 Matanuska-Susitna Borough Comprehensive Development Plan, Public Facility Draft.
- March 5, 1983, "Scoping Sessions," Technical Memorandum No. 6.

March 8, 1983, "Public Involvement Plan," Technical Memorandum No. 4.
March 8, 1983, "Scoping Corridor Evaluation," Technical Memorandum No. 5.
March 8, 1983, Scoping Report.
November 21, 1983, "Onshore Geotechnical Analysis," Technical Memorandum No. 3.
November 29, 1982, #13 Knik Arm Crossing Scoping Document.
October 1971, Knik Arm Highway Crossing.
October 21, 1983, "Public Involvement Corridor Alternatives Analysis," Technical Memorandum No. 14.
October 3, 1984, #61 Public Hearing.
October 4, 1984, #62 Public Hearing.
October 9, 1994, #63 Public Hearing.
September 14, 1983, #28 Public Hearing.
September 1983, #30 Knik Arm Crossing Proposals—An Air Force Evaluation.
September 1984, Geological & Geotechnical Considerations.
September 1984, Knik Arm Crossing Newsletter, No. 6.