

CTAT UPDATE

LEGEND

| |
|-----------------------|
| Can Depl Now |
| Visa or PP in Process |
| Visa Not Submitted |

VISA / PASSPORT STATUS

| POSN | JOR | LEB |
|--------|----------|--------|
| Lead | Deployed | |
| SM | Deployed | |
| Int O | Deployed | |
| Log O | Deployed | |
| Sig | Deployed | |
| FP x 2 | Deployed | |
| FP x 2 | 15 Oct | 15 Oct |

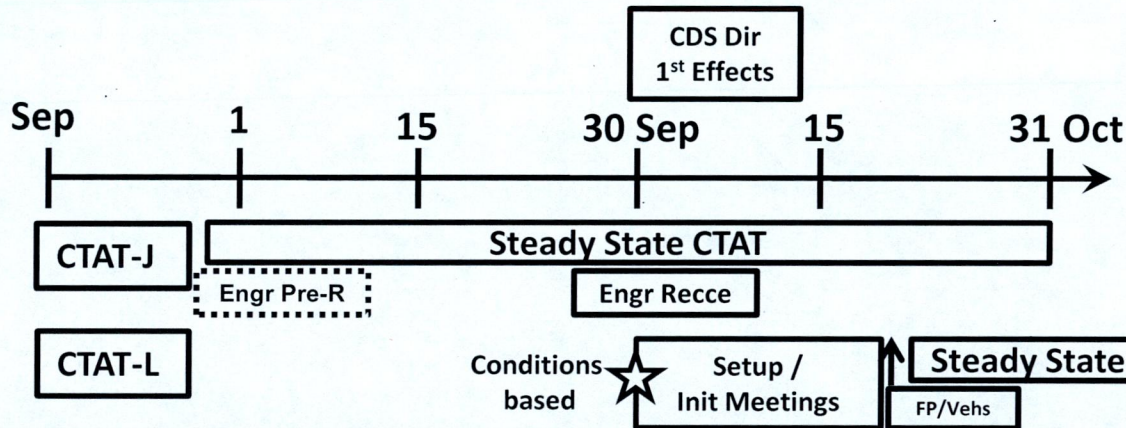

CURRENT SITUATION

- CTAT-L on 7 days NTM

PROJECTS - JORDAN

- Pri 1 - Border OP Access Route
- Pri 2 - NVGs/ISR eqpt/trg
- Pri 3 - Border OP QOL Infra
- Pri 4 - QRF Wet Weather Gear
- Pri 5 - JTAC and Log Sp Trg

PROJECTS - LEBANON

- Pri 1 - Eqpt/Trg Initiatives
- Pri 2 - Mountain Gear/Trg
- Pri 3 - Winter Gear

COORD

- Movt:
- CONOPs approved by Comd JTF-I
- Veh pax/veh through JTF-I
- except for trg
- PPE: in go bag

C2

- OPCOM JTF-I
- DSR and MOVECON
- JTF-I KLE during RSOMI
- Comms
- DWAN
- CAN BB and Local Cell
- Iridium
- Liaison
- CJOC-J LNO
- CDA JOR & CDA LEB

SUPPORT

- Accn: Has compliant bidders
- Veh: Has compliant bidders
- LEP/RLS, Contracts will be done by Log Os once depl

ISSUES

- LEB Visa (At OT)
- LEB Embassy Support

CTAT-J REINFORCEMENT

| SER | ORG | REMARKS |
|-----|--|--|
| ① | CJOC HQ | <ul style="list-style-type: none"> FE Project Management |
| ② | JTF - I | <ul style="list-style-type: none"> C2 |
| ③ | CDA - J & Embassy (2) (+2 on 1 Sep) (LCol & Maj Foote) | <ul style="list-style-type: none"> Liaison & facilitation with Jordanian Govt & GAC |
| ④ | CDA Tel Aviv (1 - LCol) MC Space = 9 | <ul style="list-style-type: none"> Regional engagements, oversight & coordination |
| ⑤ | CJOC - J LNO (Under Op FOUNDATION) (1 - LCol) | <ul style="list-style-type: none"> Coalition engagements via Build Partner Capacity |
| ⑥ | CJTF-OIR CJ7 (1 - BGen Anderson) | <ul style="list-style-type: none"> Coalition Training |

17

| CTAT-J PROJECTS |
|---|
| <ul style="list-style-type: none"> Pri 1 - Border OP Access Route Pri 2 - NVGs/ISR eqpt/trg Pri 3 - Border OP QOL Infra Pri 4 - QRF Wet Weather Gear Pri 5 - JTAC and Log Sp Trg |

15.1

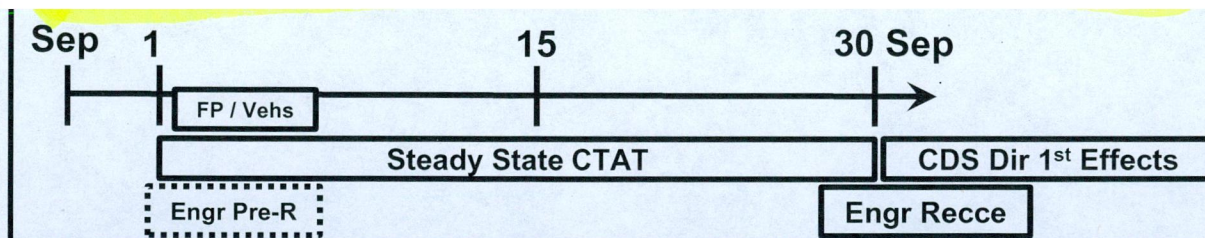

RECCE OBJECTIVES

- Confirm JAF requirements
- Gather data on the state of the road IOT define the feasibility, scope of work and ROM of costing and work flow.
- Confirm the capacity and capability of JAF Engr and local contractors (aggregate, rental of Heavy Eqpt and construction)
- Establish liaisons (with JAF, potential contractors & provider)
- Investigate
- Force Protection estimate for Engr work

Pre-Engr (TAV) Recce Composition (6)

- Maj T.W. (Lead, CJOC HQ J Engr)
- 2 x Hor Constr SMEs (CFJOSG 1 ESU)
- 1 x CE Supt SME (CFJOSG 1 ESU)
- 1 x Hy Eqpt SME (CFJOSG 1 ESU)
- 1 x Survey Tech (CFJOSG 1 ESU)

CTAT Support

- Force protection Coordination
- Movement
- Linguistic / Liaison
- Log O (contracting assessment, reach back J4 contracts)

CONCERNS / ISSUES

- Threats & Hazards
- Local contracting capacity & capability

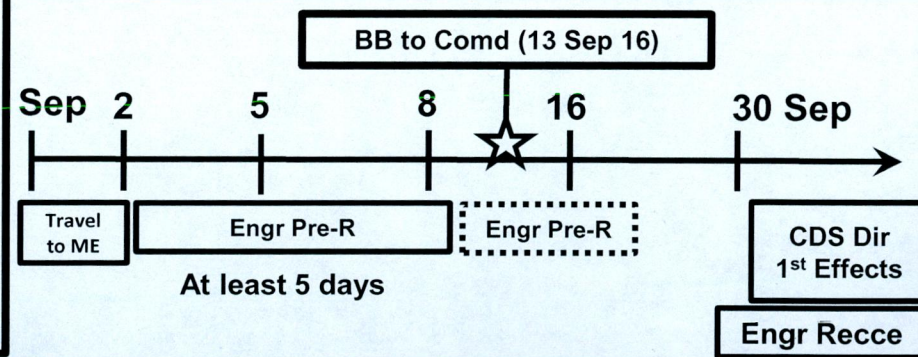

Page 4004

**is withheld pursuant to section
est retenue en vertu de l'article**

15(1)

**of the Access to Information Act
de la Loi sur l'accès à l'information**

TAC AVN TO&E

Problem Statement (JFACC / 1 Wing) - Sustain a combat capable Tac Avn Det in support of Op IMPACT, be postured to sustain second deployed location (Africa TBC), while minimizing impact to its FP&R and YFR allocation

MACRO RCAF MRP

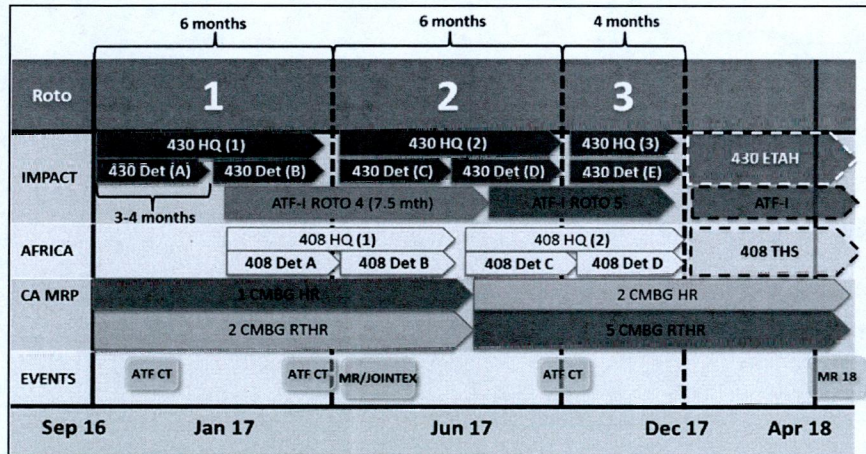

MICRO RCAF OP IMPACT OPTION

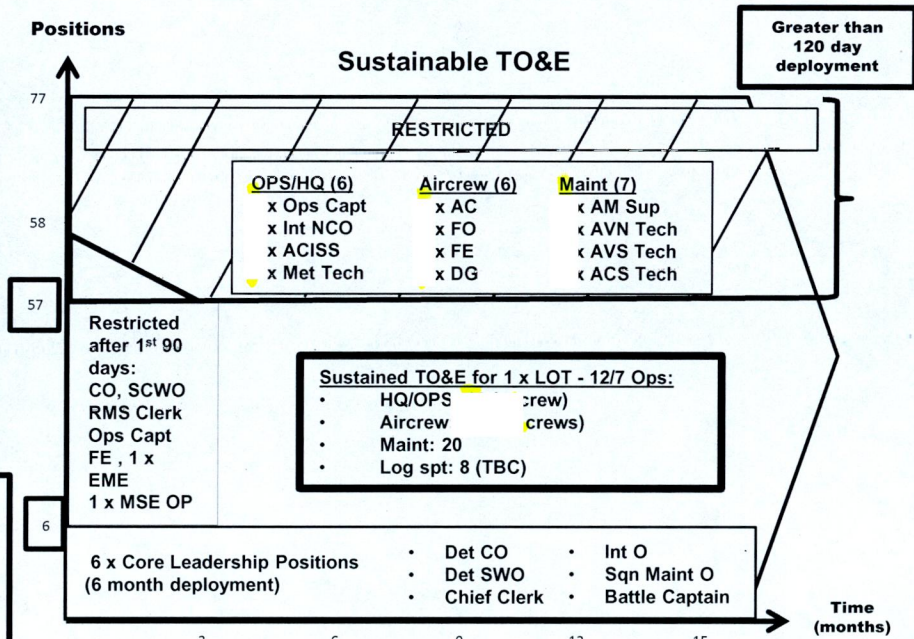

Background

- Initial CONOPs -
- 1x Line of Task (LOT) daily

Current Ops Tempo

- Average mission duration (longest)
- Weekly flying rate of aircraft
- Mission: Troop/VIP transport (primary)
 - Deliberate Ops: Secondary for casevac standby and

Assumptions

- 12/7 Flying Ops: 1x 8 hr LOT (2x CH146)
- Tac Avn Det [core] leadership will deploy for 6 - 8 months
- 1 Wing will fill ATF HQ A5/OSE and Los
- Enable sustainment until 31 Dec 17

Manning

- Unit establishment can only FG / Sustain 2 x Rotos with a 77 pers TO&E (reconstitution period)
- Short rotos (90 days) permit same pers to redeploy for a 2nd 90 day roto within 12 months

Advantages

- Indefinitely sustainable (incl simultaneous deployments)
- Reduced risk to execute YFR allocation (unit flexibility)
- Reduces DAG RED risk / Reduces Repat Risk
- Optimized TO&E/reduced requirements for augmentation (no HLTAs)

COMD CJOC RFIs - CONDITIONAL APPROVAL FOR 90 DAY TOURS AND 57 PERS TO&E

- If needed, time required to FG and surge back to 2 x Lines of Task for 24/7 operations
- Potential impacts to the capacity of deploying and sustaining a second Line of Operations in another theatre

ERBIL CAMP BUILD

SITREP

- Confirming impacts of VISA delays on R2B IOC/FOC
- JOC completion delayed from 31 Aug to 10 Sep (contractor delays)

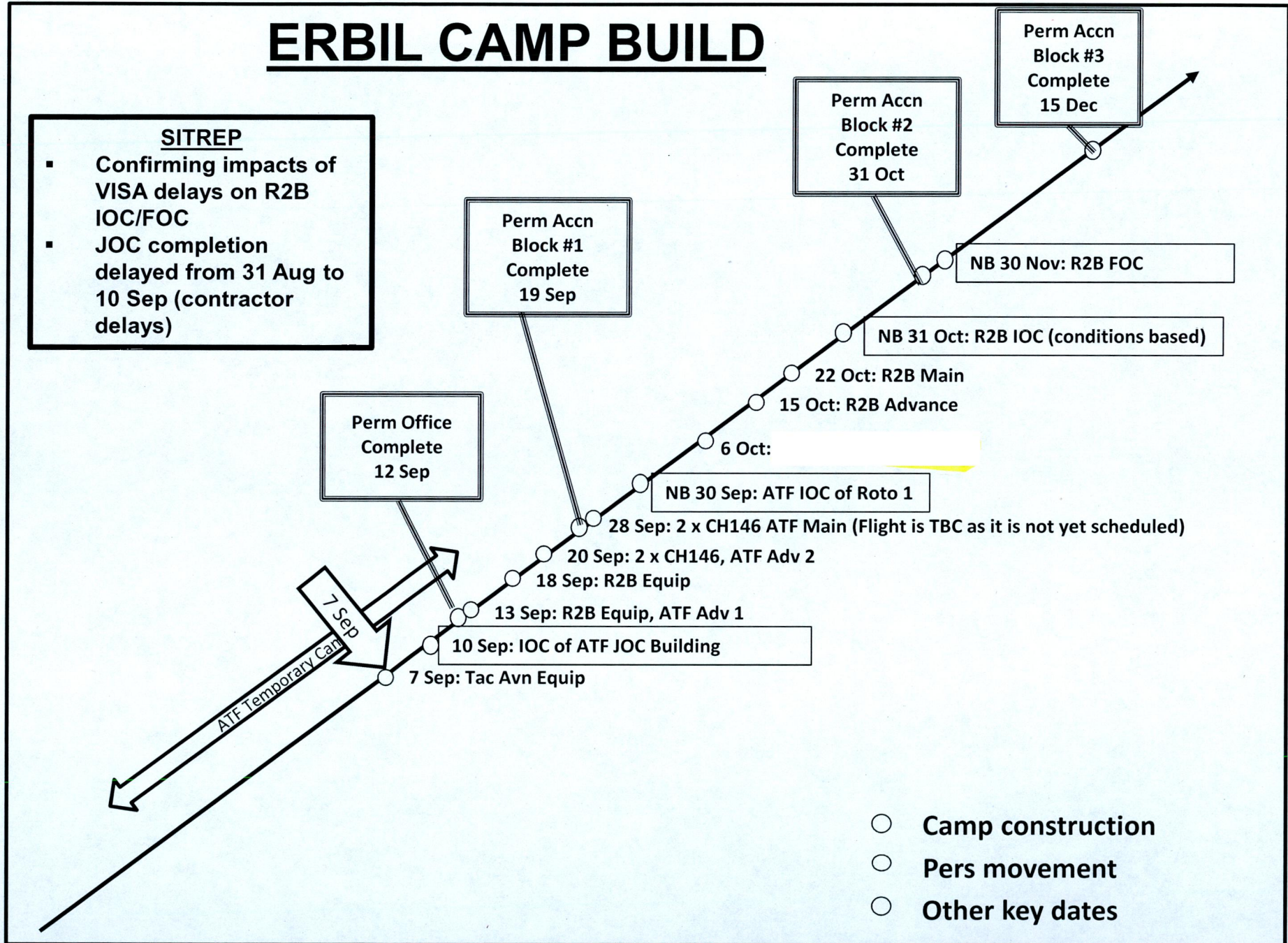

15.1

MLT

UPDATE

Provisional ECM Timeline

NOTE:

Acquisition = ADM(Mat)/PSPC Lead - FMS, timeline TBC
 Integration = CA/US DoS lead,
 Testing = CA/ADM(S&T) Lead,
 CALIFORNIA
 Installation = DoS Lead, in theatre

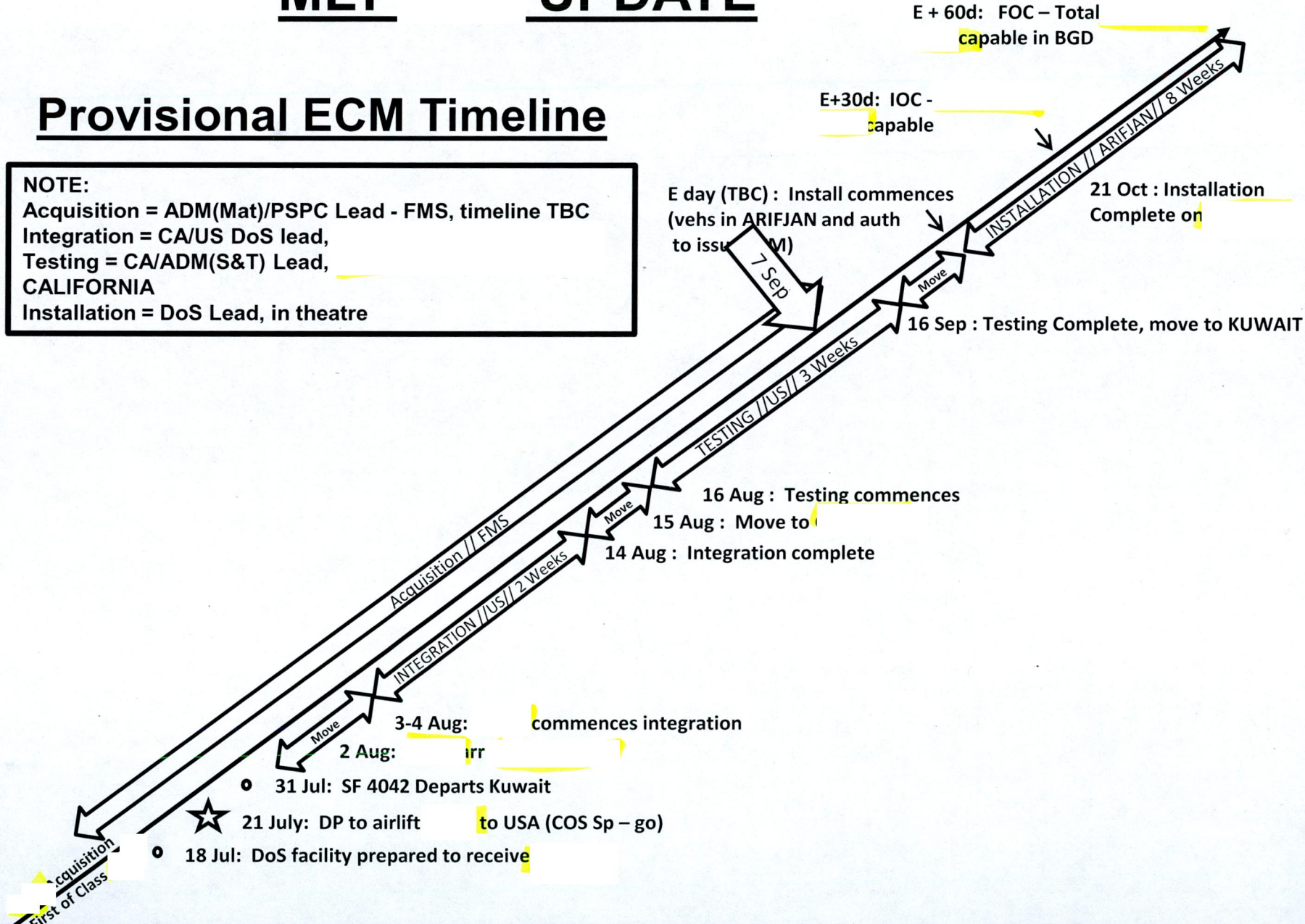



Commander's Weekly Update

OPERATIONS

12 September 2016

AGENDA

- **Op IMPACT**
 - **CTAT Update (J3 ME)**
 - **CTAT-J Projects (J5)**
 - **Erbil Update (COS Sp)**
 - **Role 2 Deployment Playbook (J3 ME / J5)**
 - **Tac Avn Update (J3 ME)**
 - **Media Update (J3 / PA)**
 - **MLT Placemat (J3)**
 - **Mosul Liberation and Mosul L+1 (J5)**
- **Op SOPRANO HSS Update (J3 AFR)**
- **Comd's Direction**

CTAT UPDATE

LEGEND

| |
|-----------------------|
| Deployable |
| Visa or PP in Process |

VISA / PASSPORT STATUS

| POSN | JOR | LEB |
|--------|----------|--------|
| Lead | Deployed | |
| SM | Deployed | |
| Int O | Deployed | |
| Log O | Deployed | |
| Sig | Deployed | |
| FP x 2 | Deployed | |
| FP x 2 | 15 Oct | 15 Oct |

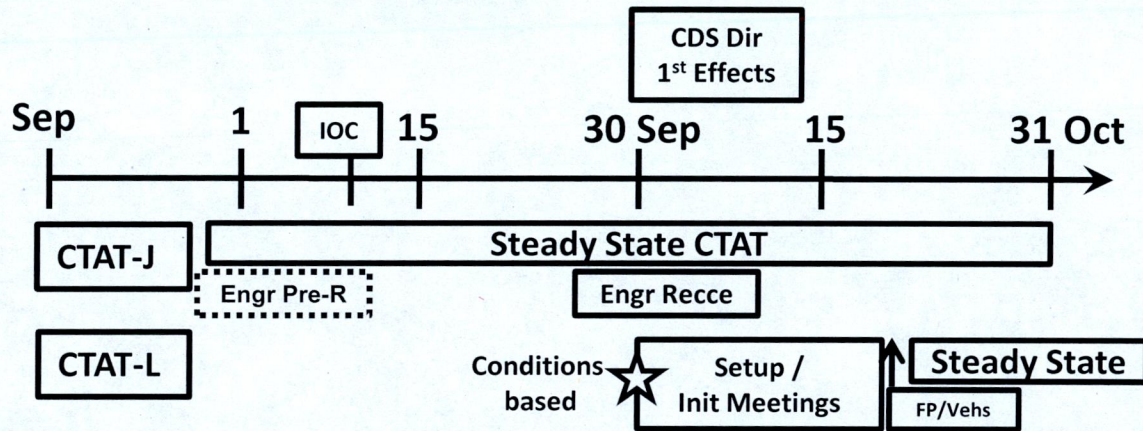

CURRENT SITUATION

- CTAT-L on 7 days NTM
- CTAT-J is IOC (9 Sep, JTF-I)

PROJECTS - JORDAN

- Pri 1 - Border OP Access Route
- Pri 2 - NVGs/ISR eqpt/trg
- Pri 3 - Border OP QOL Infra
- Pri 4 - QRF Wet Weather Gear
- Pri 5 - JTAC and Log Sp Trg

PROJECTS - LEBANON

- Pri 1 - Eqpt/Trg Initiatives
- Pri 2 - Mountain Gear/Trg
- Pri 3 - Winter Gear

COORD

- Movt:
 - CONOPs approved by Comd JTF-I
 - 'eh / pax/veh through JTF-I
 - for trg
- PPE: in go bag

C2

- OPCOM JTF-I
- DSR and MOVECON
- JTF-I KLE during RSOMI
- Comms
 - DWAN
 - CAN BB and Local Cell
 - Iridium
- Liaison
 - CJOC-J LNO
 - CDA JOR & CDA LEB
- ROE
 - ROEAUTH (9 Sep)

SUPPORT

- Accn: Has compliant bidders
- Veh: Has compliant bidders
- LEP/RLS
 - Contracts will be done by Log Os once depl

ISSUES

- LEB Visa (At OT)
- LEB Embassy Support
- Accommodations

CTAT-J PROJECTS

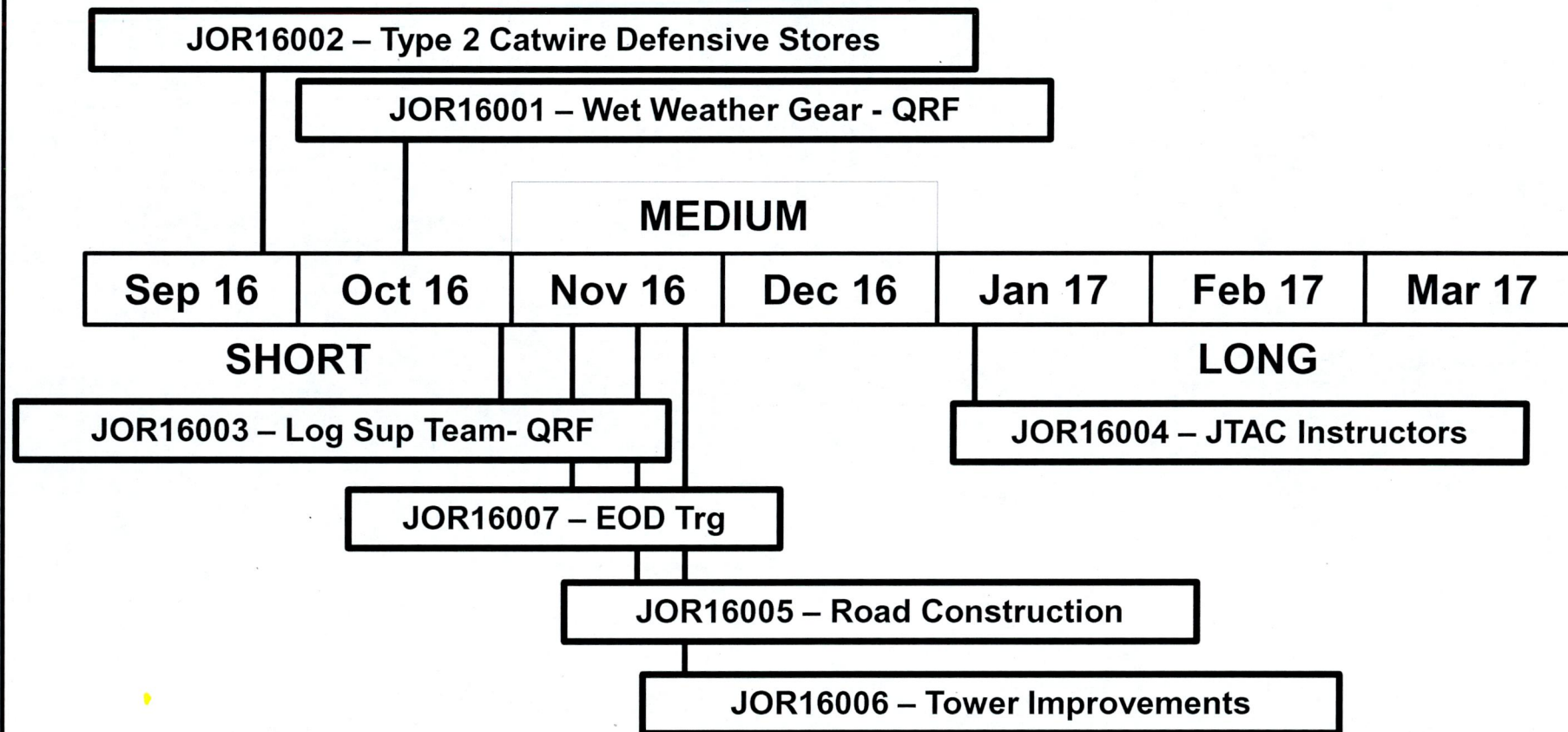

JOR 16008

- Heavy Eqpt training for the Royal Engrs will require a TAV for further analysis
- Also being investigated for BPC projects are Sr NCO Training and support to the Women's Centre of Excellence

ERBIL UPDATE

SITREP

- R2B IOC delayed

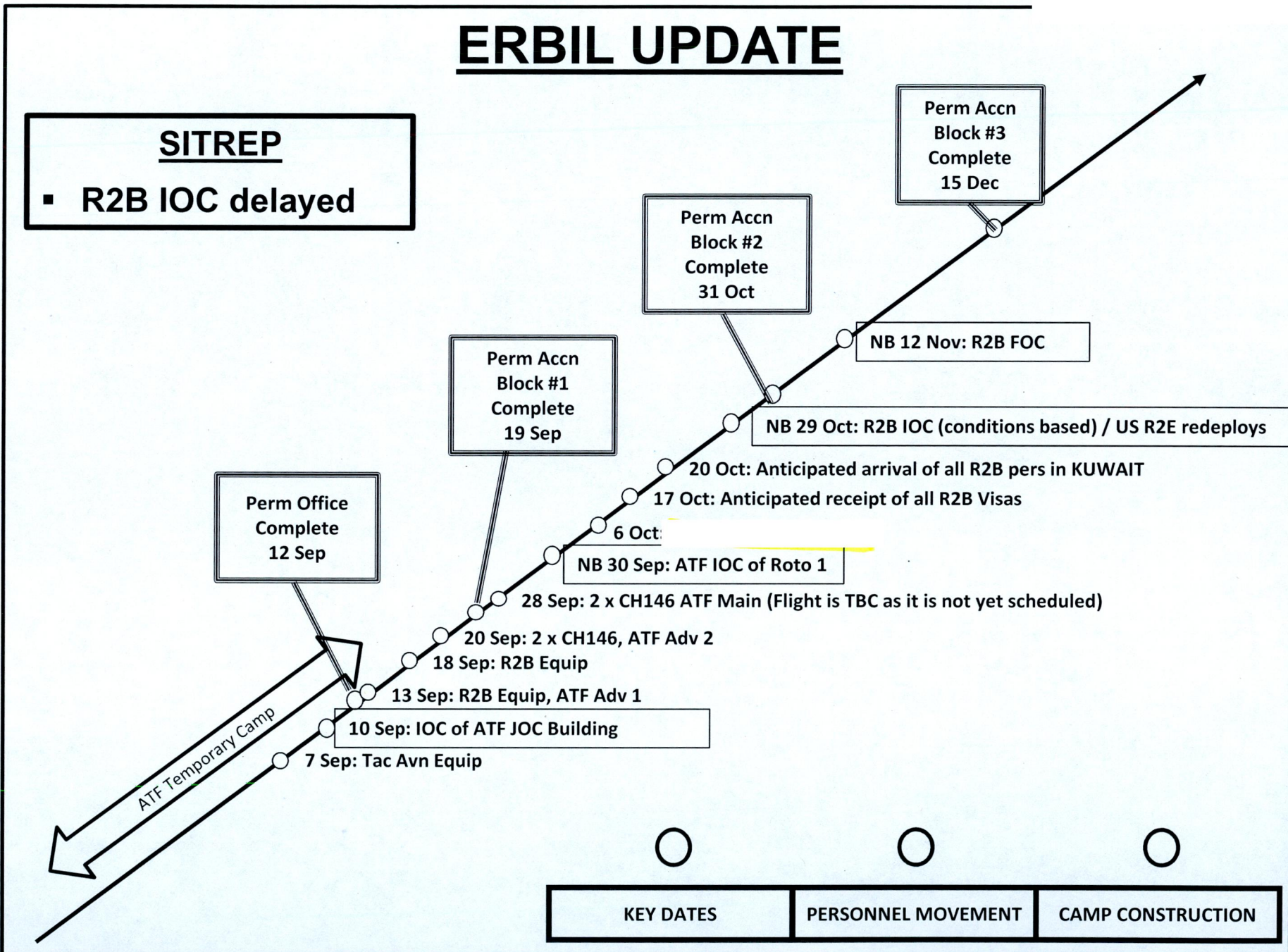

15,

ROLE 2 DEPLOYMENT PLAYBOOK

VISA / PASSPORT STATUS

| Position | Requested | Approved |
|-----------|-----------|----------|
| R2B | 49 | 1 |
| Tac Avn | 77 | 77 |
| JTF-I Det | 31 | 15 |

COORD

- Critical Mass (Identified Positions)
- IOC (Identified Positions)

★ DECISION POINT

- Use of SF or Coalition Airlift
- Issue of visa – 5 days prior

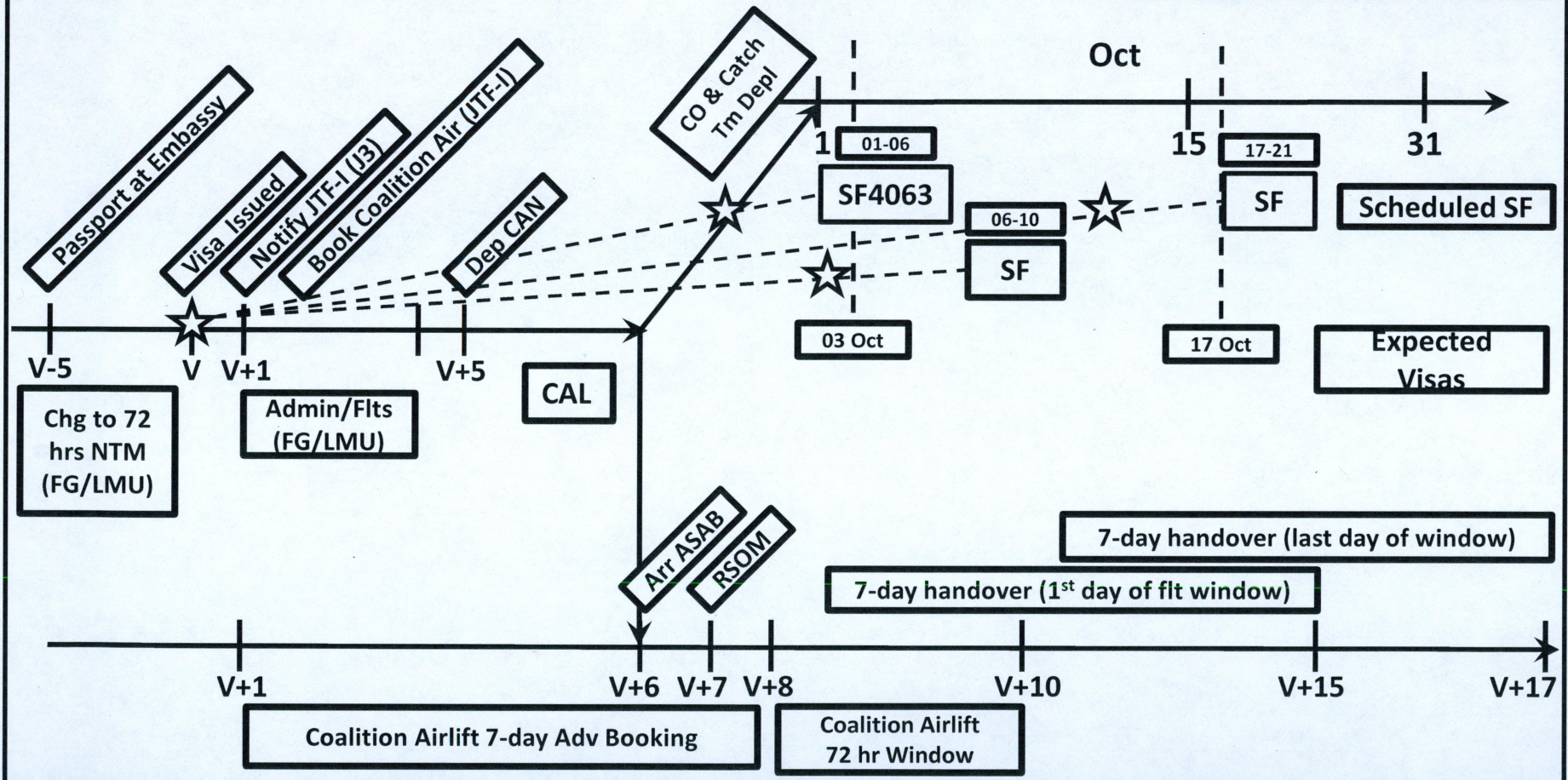

TAC AVN UPDATE

**COMD CJOC RFIs -
CONDITIONAL APPROVAL FOR
90 DAY TOURS AND 57 PERS
TO&E**

- CANSOFCOM consent, noting impacts on RIP
- If needed, time required to FG and surge back to 1 x LOT for
- Potential impacts to the capacity of deploying and sustaining a second Line of Operations in another theatre

| | 427 THS / SOAD | 430 ETAH / Tac Avn Det |
|--------------------|---|---|
| Mission | Command & Liaison, Transport, CASEVAC (In Extremis) | |
| Aircraft | 1 CH146 | 3 x CH146 (4 x CH146 mid-Nov 16) |
| Personnel | | |
| Aircrew | (includes C2) | 3.5 aircrew / 0.5 ops (4) |
| Status | Undeclared | |
| Task Auth/C2 | | |
| Line of Task (LOT) | 1 LOT - <u> </u> | 1 LOT - <u> </u> |
| Surge | N/A | 1 LOT Risk: <u> </u> |
| In Extremis | Supportable beyond <u> </u> | |
| ATO | <u> </u> - Ground Alert | |

15(1)

15-1

Relief-In-Place Plan - 427/430 Sqn

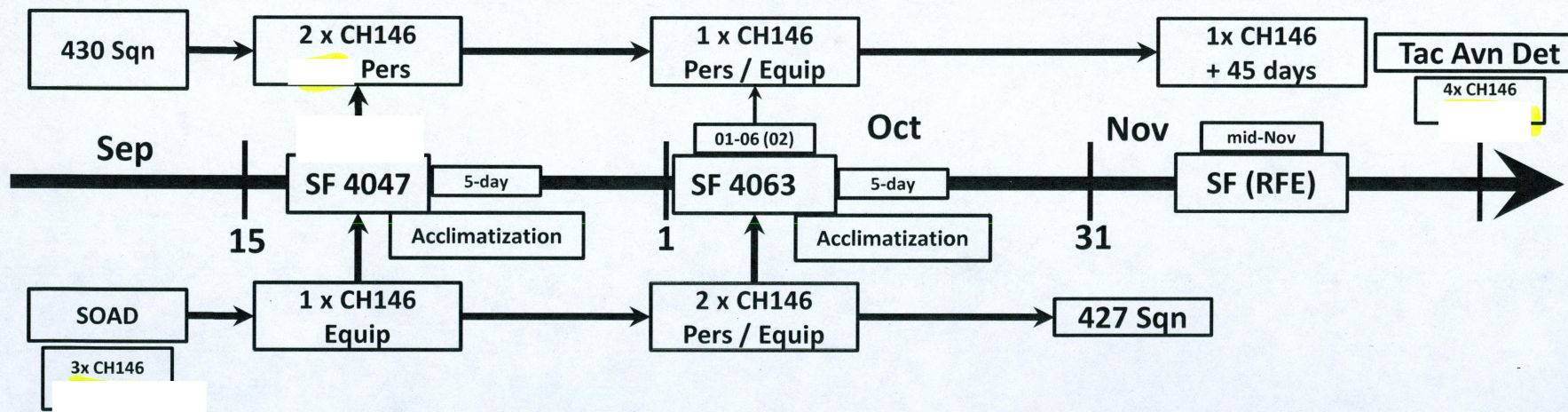

MEDIA UPDATE

- **Op IMPACT Tech Brief by MND / CDS**
 - **Rehearsal 4 1330-1500 Oct 16**
 - **Live 5 1000-1200 Oct 16**
 - **Dates pending MND & CDS acceptance**
- **Op IMPACT Media Visit: 6-10 Nov 16**
 - **1 x Day at JTF-I HQ ASAB**
 - **1 x Day at JTF-I Det Erbil (Minimal Disruption**
 - **3 x Media Agencies Pers Total)**
- **Full visit update during Op IMPACT Update Brief on 14 Sep 16**
- **No information from PCO on PM visit in Oct 16**
 - **SJS Investigating**

13-1

MLT PLACEMAT – CONOP DELEGATION

DELEGATION CRITERIA

must be available and postured

PERSONNEL: At a minimum, every COMMS At a minimum there must be a

means of communication. This applies to the following: element and the ; and the

RESIDUAL RISK: If the Residual Risk of any scenario is assessed as the delegation of authority to

MEDICAL

- Medical Assets / Resources
 - Integral (TCCC for CP)
 - Facilities
 - Role 1 at UIII
 - Role 2 at BDSC
- C2
 - Reporting Chains
 - CJTF-OIR, RSO (JTF-I notified immediately)

COMMS PLAN

- at UIII during movt. Comms is maintained with
- P – Radio comms within convoy –
- A – Iridium Sat Phones
- C – Local Cell Phone Secure App (What's App)
- E – Blackberry

15-1

MLT DIR MACRO ASSESSMENT

Atmospherics
The security situation in Baghdad continues to be stable with the persistent armed presence by Iraqi Security Forces. There have been absolutely **NO (0)** situations or events that any member of the MLT has felt threatened. I firmly believe that the most likely threat to low-profile personal movements in BAGHDAD remains a "wrong place, wrong time" scenario

Pattern of Life
Iraqi pattern of life has been consistent since arrival in Baghdad. Citizens continue on with their daily affairs with the knowledge of the overt security presence and the elevated vigilance of the Iraqi Security Forces throughout Baghdad.

Trends
Procedures and movement continue to be strictly controlled through the use of permanent checkpoints of which vehicles require the appropriate documentation to transit through. This has remained constant.

**Pages 4017 to / à 4018
are withheld pursuant to section
sont retenues en vertu de l'article**

15(1)

**of the Access to Information Act
de la Loi sur l'accès à l'information**



Commander's Weekly Update

OP IMPACT

14 September 2016

AGENDA

- **Personnel & Capability Update (J3 ME)**
- **CTAT Update (J3 ME)**
- **CTAT-J Projects (J5)**
- **Role 2 Deployment Playbook (J3 ME / J5)**
- **Erbil Camp Build Update (COS Sp)**
- **Media Update (J3 / PA)**
- **Fall Visits Update (J3 ME)**
- **Comd's Direction**

PERSONNEL AND CAPABILITY IN-FLOW

| | 1 Jun | 1 Jul | 1 Aug | 1 Sep | 1 Oct | 1 Nov | 1 Dec |
|----------------------|------------------|--|-----------------|------------------------------|----------------------|--------------------------------|------------|
| JTF-I/HQ 53/1 | | | | | | | |
| FHT 9 | | | | | 11 (+2 Tm Mbrs) | | |
| MH 2 IOC FOC | | | | | | | |
| JTFSC 105/6 | | | | | | | |
| ATF-I 142/11 | | | | 150/11 (+8 ATF-I HQ) | | | |
| JTF-I Det Erbil | | | | 31 (HQ/JTFSC) 8 (Tac Avn) | 43 (R2B) 46 (+38) | 49(+6 R2B) 57 (+11 Tav Avn) | |
| ASIC 43/1 | | | | FOC | | | |
| Embeds 15 | | | 30 (new embeds) | | 2 (CSEC & ITAC) | | |
| MLT _{IOC} 5 | 8 (MLT Adv + FP) | 14 (Med, FP, Linguist, Clk) Int'l Zone Move | 20 (Int O, CP) | IOC 22 (+2 FP) | 26 (+4 FP) | | Zone Move |
| CTAT | | (13) LoE4 Recce 8-19 July | | 5 (CTAT-J 7 (+2 FP) | 9 (+2 FP) | | 9 (CTAT-L) |

| (Tac Avn Det) | 01 Jun | 18 Jun | 03 Jul | 28 Jul | 18 Aug | 01 Sep | 15 Sep | 01 Oct | 15 Oct | Nov |
|---------------|--------------|--------|--------|--------|---------------|--------|---------------|--------|--------|-----|
| | 506 | 537 | 543 | 558 | 569 | 616 | 626 | 701 | 706 | 808 |
| | 5 Jun 509 | | | | 11 Aug 564 | | 21 Sep 664 | | | |

- RECENT MILESTONES**
- Capability
 - Theatre Opening Team (On-Going)
 - Tac Avn Det Adv Party (Deployed)
 - Authorities
 - Planning / movements
 - CTAT-J – JEngr Pre- Recce Redeployment

- CIVILIANS IN JOA**
- Total =
 - HQ =
 - ATF-I =
 - JTFSC =
 - ASIC =

- UPCOMING ACTIVITIES**
- Capability
 - MLT Vehicle
 - CTAT Lebanon
 - JTF-I Det Erbil
 - R2B Erbil
 - Planning
 - Frag O 002 (Draft)
 - TO&E Change #10

15(1)

CTAT UPDATE

LEGEND

| |
|-----------------------|
| Deployable |
| Visa or PP in Process |

VISA / PASSPORT STATUS

| POSN | JOR | LEB |
|--------|----------|--------|
| Lead | Deployed | |
| SM | Deployed | |
| Int O | Deployed | |
| Log O | Deployed | |
| Sig | Deployed | |
| FP x 2 | Deployed | |
| FP x 2 | 15 Oct | 15 Oct |

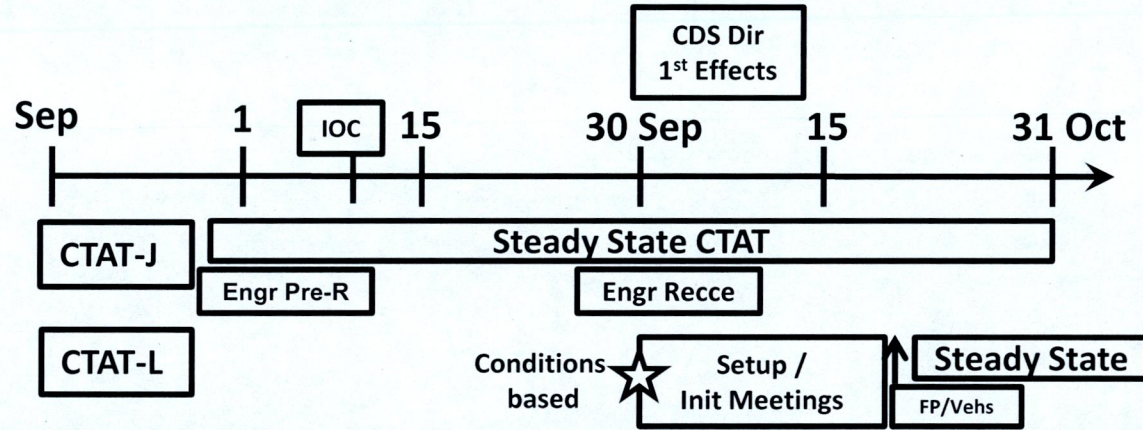

CURRENT SITUATION

- CTAT-L on 7 days NTM
- CTAT-J is IOC (9 Sep, JTF-I)

PROJECTS - JORDAN

- Pri 1 - Border OP Access Route
- Pri 2 - NVGs/ISR eqpt/trg
- Pri 3 - Border OP QOL Infra
- Pri 4 - QRF Wet Weather Gear
- Pri 5 - JTAC and Log Sp Trg

PROJECTS - LEBANON

- Pri 1 - Eqpt/Trg Initiatives
- Pri 2 - Mountain Gear/Trg
- Pri 3 - Winter Gear

COORD

- Movt:
- CONOPs approved by Comd JTF-I
- /eh
nax/veh
- for training
- PPE: in go bag

C2

- OPCOM JTF-I
- DSR and MOVECON
- KLE & RSOMI
- Comms
- CSNI/SVTC
- DWAN
- CAN BB and Local Cell
- Iridium
- Liaison
- CJOC-J LNO
- CDA JOR & CDA LEB
- ROE
- ROEAUTH (9 Sep)

SUPPORT

- Accn: Has compliant bidders
- Veh: Has compliant bidders
- LEP/RLS Contracts will be done by deployed Log Os

ISSUES

- LEB Visa (At OT)
- LEB Embassy Support
- Accommodations

15

15(1)

CTAT-J PROJECTS

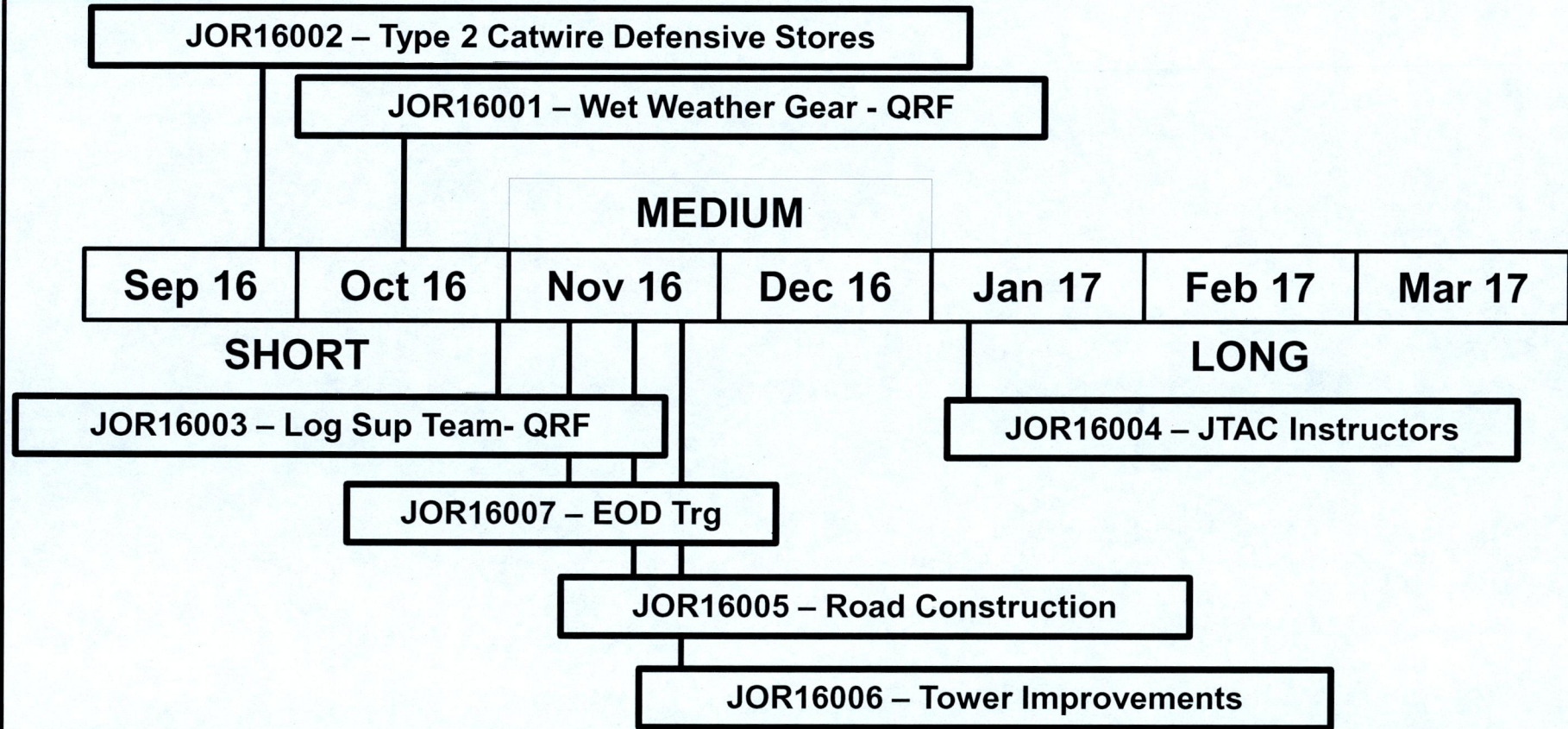

JOR 16008

- Heavy Eqpt training for the Royal Engrs will require a TAV for further analysis
- Also being investigated for BPC projects are Sr NCO Training and support to the Women's Centre of Excellence

s.15(1)

Canadian Joint Operations Command

SECRET//

ROLE 2 DEPLOYMENT PLAYBOOK

VISA / PASSPORT STATUS

| Position | Requested | Approved |
|-----------|-----------|----------|
| R2B | 49 | 1 |
| Tac Avn | 77 | 77 |
| JTF-I Det | 31 | 15 |

COORD

- Critical Mass (Identified Positions)
- IOC (Identified Positions)

★ DECISION POINT

- Use of SF or Coalition Airlift
- Issue of visa – 5 days prior

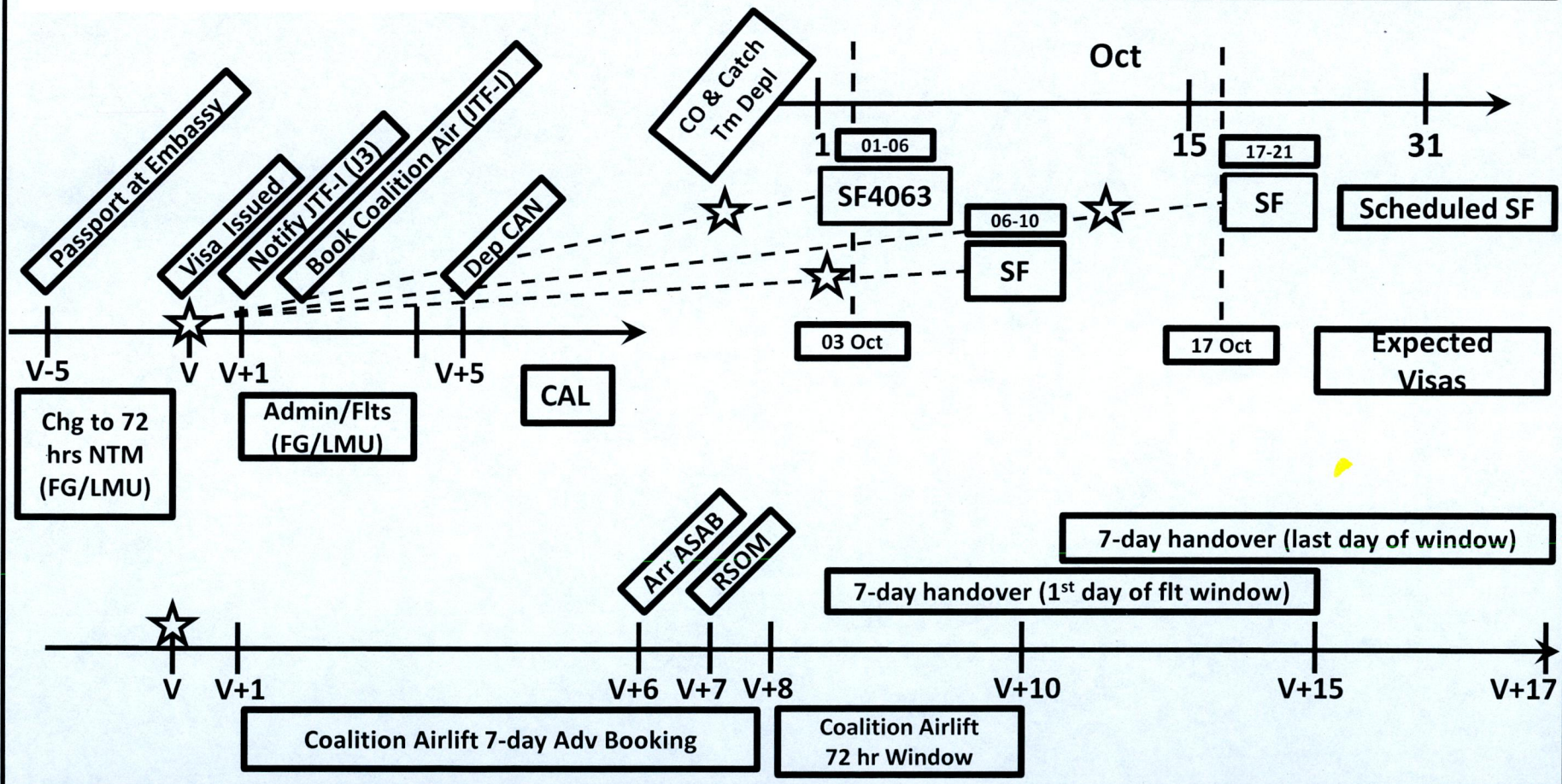

ERBIL CAPABILITY IN-FLOW

SITREP

- R2B IOC delayed to NB 29 Oct
 - R2B IOC = V+15 to V+17
 - R2B FOC = V+25

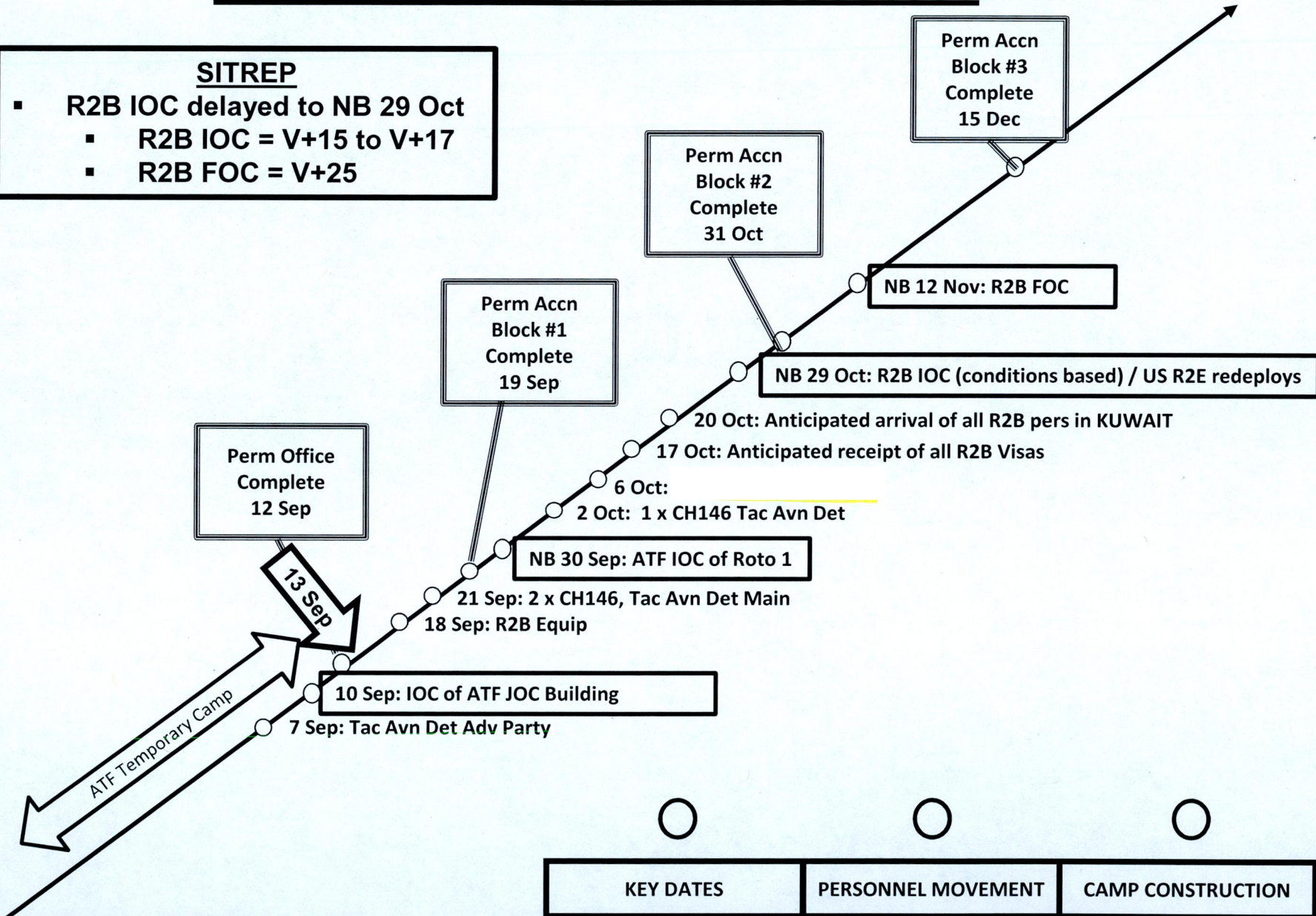

| KEY DATES | PERSONNEL MOVEMENT | CAMP CONSTRUCTION |
|-----------|--------------------|-------------------|
|-----------|--------------------|-------------------|

MEDIA UPDATE

- **Op IMPACT Tech Brief by MND / CDS**
 - **Rehearsal 4 Oct 16, 1330-1500**
 - **Live 5 Oct 16, 1000-1200**
 - **Dates pending MND & CDS acceptance**
- **Op IMPACT Media Visit: 6-10 Nov 16**
 - **1 x Day at JTF-I HQ ASAB**
 - **1 x Day at JTF-I Det Erbil (No Disruption to TF 66)**
 - **3 x Media Agencies (6 Pers Total)**

VISITS

| AGENCY | SEP | OCT | NOV | DEC | REMARKS |
|-------------|---------|--------|---------|---------|--|
| CFJOSG | 21 - 24 | | | | |
| SHOW TOUR | | 24 - 2 | | | Show = 29 Sep |
| PMO | | TBC | | | ▪ SJS / PCO |
| COMD RCAF | | | 27 - 28 | | ▪ Pers ▪ Dep Minister ▪ 5 Hon Cols ▪ 5 RCAF |
| COMD (ME) | | | 29 - 5 | | |
| MEDIA | | | 6 - 10 | | ⌋ Agencies ⌋ Pers |
| TCIT | | | 19 - 21 | | |
| COMD (GULF) | | | | 27 - 3 | |
| COMD 1 CAD | | | | 7 - 8 | ▪ Pers |
| SURG GEN | | | | 22 - 26 | ▪ Over X-Mas |

NOTE:

- Comd JTF-I HLTA 21 Oct to 7 Nov 16



Commander's Weekly Update

OP IMPACT

21 September 2016

AGENDA

- **Personnel & Capability Update (J3 ME)**
- **ROEIMP Changes (J3 ROE)**
- **CTAT Update (J3 ME)**
- **CTAT-J Projects (J5)**
- **CTAT-J Border Infrastructure Recce Playbook (J3 ME)**
- **Erbil Camp Build Update (COS Sp)**
- **Tech Brief and Media Visit Update (J3 / PA)**
- **Fall Visits Update (J3 ME)**
- **Comd's Direction**

s.15(1)

Canadian Joint Operations Command

SECRET//

PERSONNEL AND CAPABILITY IN-FLOW

| | 1 Jun | 1 Jul | 1 Aug | 1 Sep | 1 Oct | 1 Nov | 1 Dec |
|----------------------|------------------|---|-----------------|------------------------------|----------------------|--------------------------------|-------|
| JTF-I/HQ 53/1 | | | | | | | |
| FHT 9 | | | | | 11 (+2 Tm Mbrs) | | |
| MH 2 IOC FOC | | | | | | | |
| JTFSC 105/6 | | | | | | | |
| ATF-I 142/11 | | | | 150/11 (+8 ATF-I HQ) | | | |
| JTF-I Det Erbil | | | | 31 (HQ/JTFSC) 8 (Tac Avn) | 43 (R2B) 46 (+38) | 49(+6 R2B) 57 (+11 Tac Avn) | |
| ASIC 43/1 | | | | FOC | | | |
| Embeds 15 | | | 30 (new embeds) | | | | |
| MLT _{IOC} 5 | 8 (MLT Adv + FP) | 14 (Med, FP, Linguist, Clk) one Move | 20 (Int O, CP) | IOC 22 (+2 FP) | 26 (+4 FP) | one Move | |
| CTAT | | (13) LoE4 Recce 8-19 July | 5 (CTAT-J) | 7 (+2 FP) | 9 (+2 FP) | | |
| | | | | | 9 (CTAT-L) | | |

154

| (Tac Avn Det) | 01 Jun | 18 Jun | 03 Jul | 28 Jul | 18 Aug | 01 Sep | 15 Sep | 01 Oct | 15 Oct | Nov |
|---------------|--------------|--------|--------|--------|---------------|--------|---------------|--------|--------|-----|
| | 506 | 537 | 543 | 558 | 569 | 616 | 626 | 701 | 706 | 808 |
| | 5 Jun 509 | | | | 11 Aug 564 | | 22 Sep 664 | | | |

- RECENT MILESTONES**
- Capability
 - Theatre Opening Team (On-Going)
 - Tac Avn Det Main - 21 Sep/2xCH146- 22 Sep
 - Authorities
 - Planning / movements

- CIVILIANS IN JOA**
- Total =
 - HQ =
 - ATF-I =
 - JTFSC =
 - ASIC =
 - WoG/OGD =

- UPCOMING ACTIVITIES**
- Capability
 - MLT Vehicle /
 - CTAT Lebanon
 - JTF-I Det Erbil
 - R2B Erbil (Embassy began calling for visa application)
 - ASIC (pending)
 - Planning
 - Frag O 002 (Draft)
 - TO&E Change #10

ROEIMP CHANGES

- ROEIMP Op IMPACT 2016-001 cancels the following ROEs that only relate to CF188 operations:



15-1

15(1)

CTAT UPDATE

CURRENT SITUATION

- CTAT-J is IOC
- CTAT-L
 - 23 Sep - 3 days NTM
 - 26 Sep - 24 Hrs NTM

PROJECTS - LEBANON

- Pri 1 - Eqpt/Trg Initiatives
- Pri 2 - Mountain Gear/Trg
- Pri 3 - Winter Gear

CTAT-L Visa / Passport Status

| | |
|--------|--------------------|
| Lead | At Official Travel |
| SM | At Official Travel |
| Int O | Wrong Visa |
| Log O | At Official Travel |
| Sig | At Official Travel |
| FP x 2 | At Official Travel |
| FP x 2 | 15 Oct |

COORD

- Movt:
 - CONOPs approved by Comd JTF-I
 - CTAT-J = x Veh (pax)

PPE:

in go bag

C2

- OPCOM JTF-I
- DSR and MOVECON
- KLE & RSOMI
- Comms
 - CSNI/SVTC
 - DWAN
 - CAN BB and Local Cell
- Liaison
 - CJOC-J LNO
 - CDA JOR & CDA LEB
- ROE
 - ROEAUTH (9 Sep)

SUPPORT

- Accn: Has compliant bidders
- Veh: Has compliant bidders
- LEP/RLS
 - Contracts will be done by deployed Log Os

ISSUES

- LEB Visas (Still At OT)
- CTAT-J
 - Accommodations

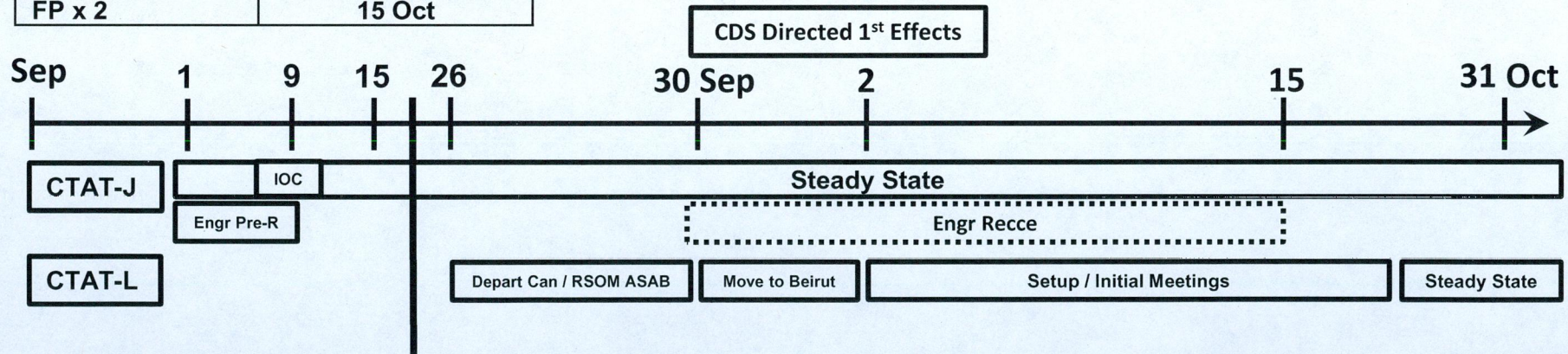

Canadian Joint Operations Command

SECRET///

CTAT-J PROJECTS

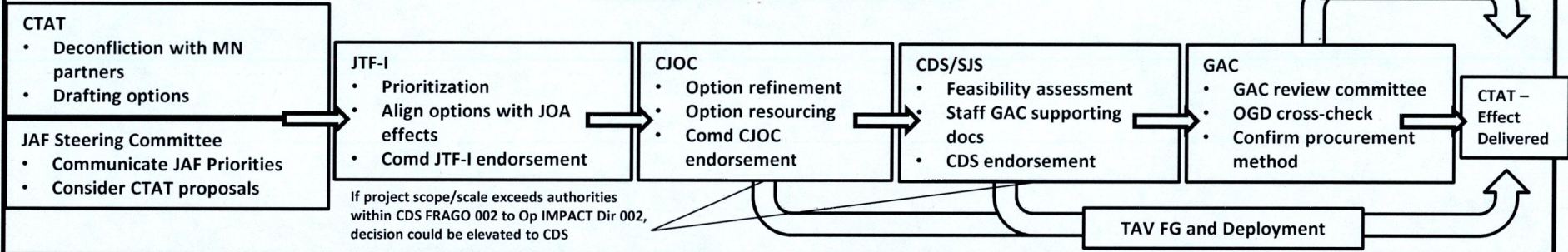

△ = Tentative delivery △ = Effect delivered △ = In progress

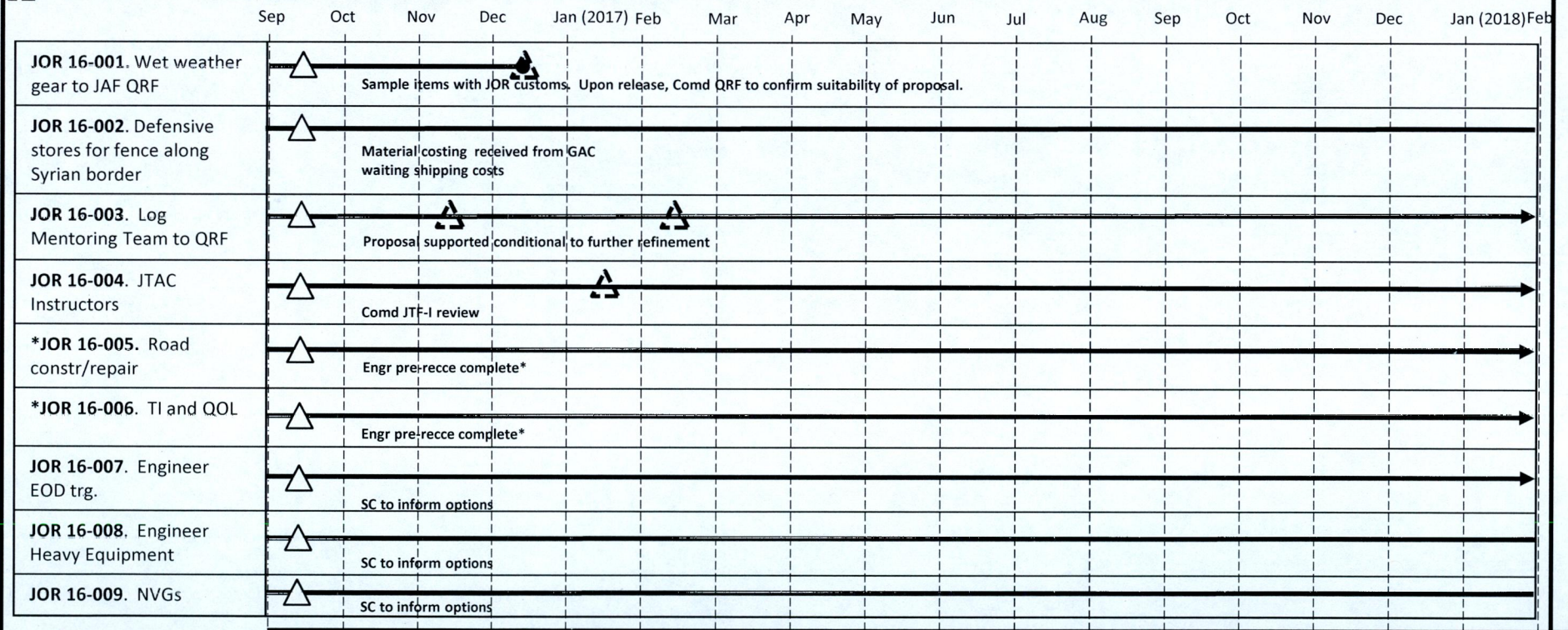

□ = Trg Project □ = Equip Project
 □ = Infrastructure Project
 Inaugural SC meeting 22 Sep (date TBC)
 *JOR 16-005 – Road Constr/repair – Further coord occurring with GER through DA in AMMAN, GAC reviewing.
 *JOR 16-006 – TI/QOL Improvements – AUS has existing project; no funding. Investigating options for CAF to take them on.

CTAT-J BORDER SECURITY INFRA RECCE PLAYBOOK

| | | |
|---|---|--|
| <p>STRATEGIC CONDITIONS</p> <ul style="list-style-type: none"> Receive JOR Steering Comm Pris Confirm CAF strategic direction Nests in COALITION efforts Matched to funding source | <p>OPERATIONAL CONDITIONS</p> <ul style="list-style-type: none"> JAF can support JTF-I and CTAT-J can support FGs can support FP and Med Risk Mitigation | <p>OTHER CONSIDERATIONS</p> <ul style="list-style-type: none"> 3-4 weeks notice to JOR req JAF Cultural / Priorities JOR Customs CAF FG Pressures Sync with CJOC activities Recce completion conditions based |
|---|---|--|

| Tactical Infrastructure Projects | | Road Projects | | Common | |
|--|--|--|--|--|---|
| Capabilities | Projects | CAF Execution | Projects | Contracted | Source |
| <p>SET</p> <ul style="list-style-type: none"> Technical / SOW Water / Waste Water Electrical Dist / Gen Structural / FP / Access Survey <p>FG: 1 ESU w/RCAF sp Pers: 12 NTM: 14 Days</p> | <p>Tower 24 Sites 21 Days</p> <p>Tower 17 Sites 19 Days</p> <p>Tower 6 Sites 17 Days</p> | <p>CAF Execution</p> <p>Capabilities</p> <p>SET (-)</p> <ul style="list-style-type: none"> Survey Soil / Drainage Technical / SOW <p>*Require backhoe</p> <p>FG: 1 ESU w/CA sp Pers: 9 NTM:14 Days</p> | <p>NWBR 62 km 25 Days</p> <p>NEBR 70 km 31 Days</p> <p>EBR 83 km 33 Days</p> | <p>TBC with DCC</p> | <p>Comd / FP Plan ??</p> <p>J2 CTAT</p> <p>J4 CTAT</p> <p>J6 CTAT</p> <p>HSS JTF-I(TBC)</p> <p>Integral Sp</p> <p>Sig / Dvr /</p> <p>Med / Ling (LEP)</p> |

151

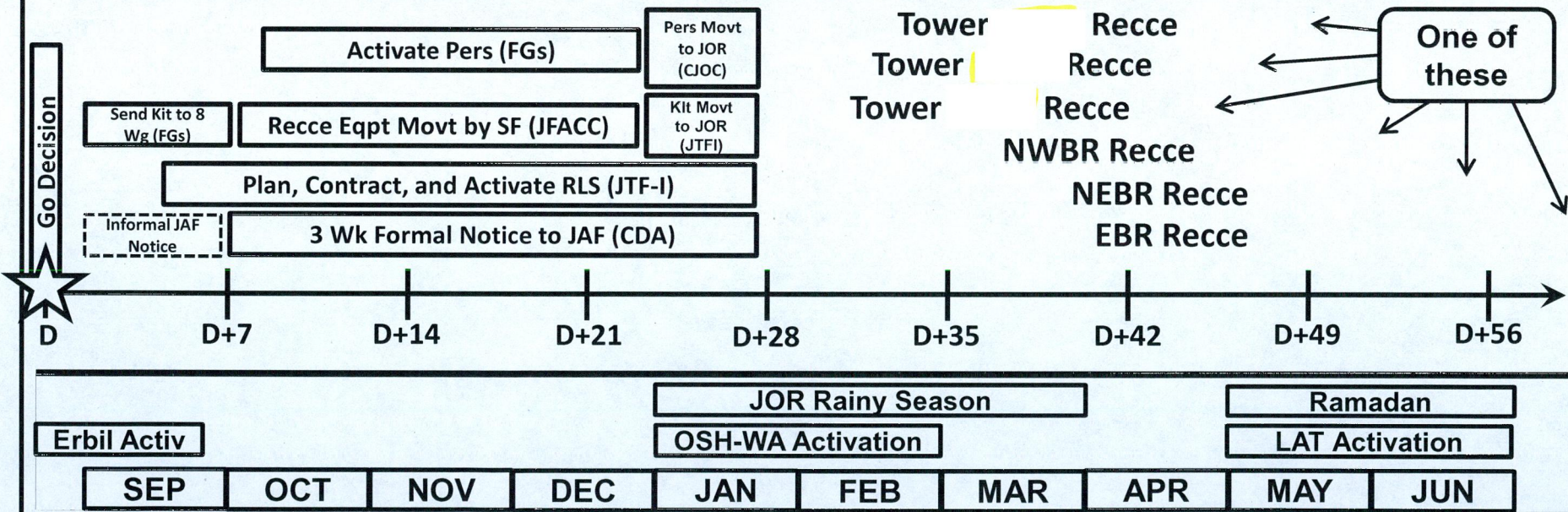

ERBIL CAPABILITY IN-FLOW

VISA / PASSPORT STATUS

| Position | Requested | Approved |
|-----------|-----------|----------|
| R2B | 49 | 1 |
| Tac Avn | 77 | 77 |
| JTF-I Det | 31 | 15 |

SITREP

▪ No change

15-1

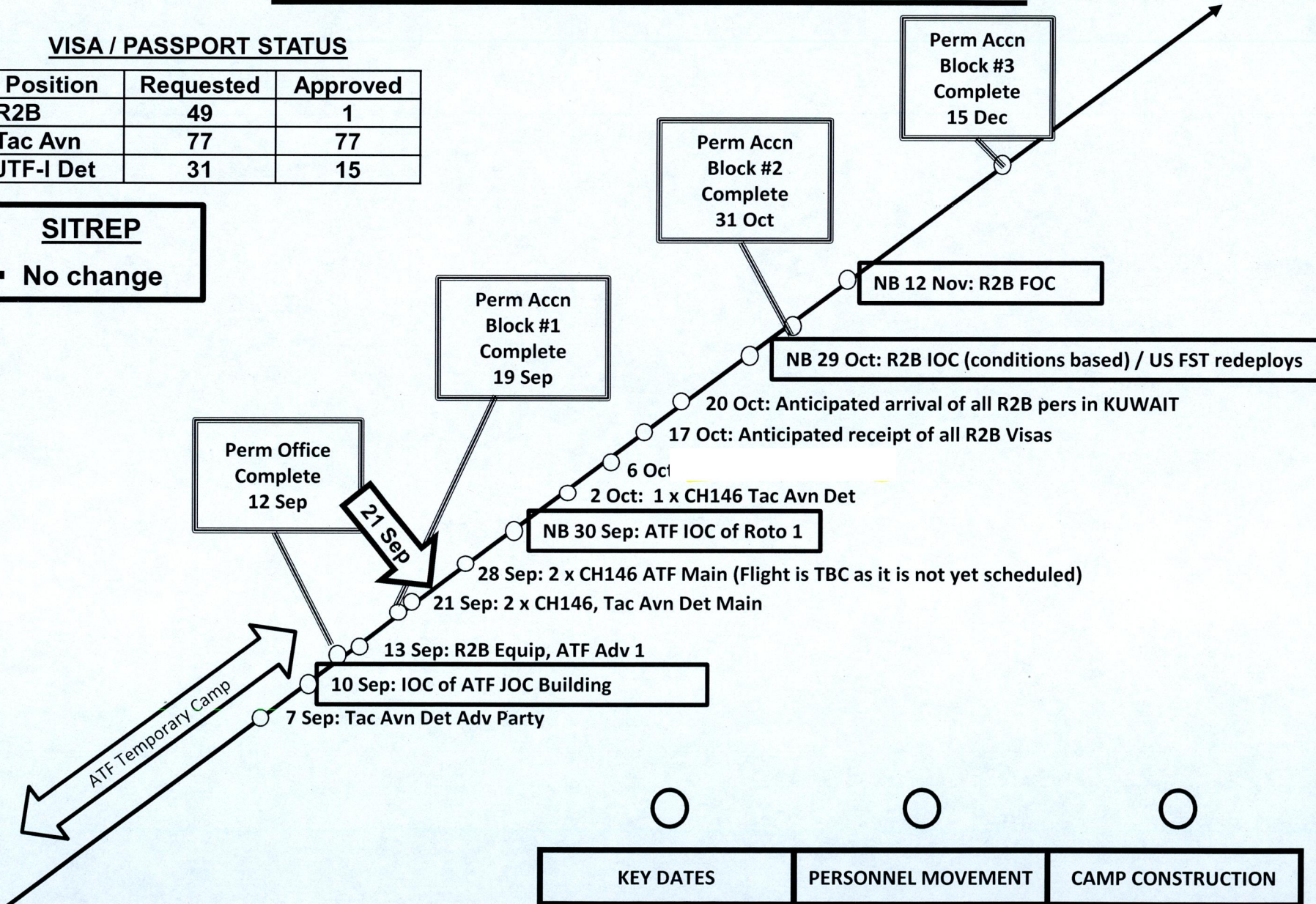

| | | |
|-----------|--------------------|-------------------|
| KEY DATES | PERSONNEL MOVEMENT | CAMP CONSTRUCTION |
|-----------|--------------------|-------------------|

MLT UPDATE

| | | |
|-----------|---------|----------|
| SEPTEMBER | OCTOBER | NOVEMBER |
|-----------|---------|----------|

INSTALLATION // ARIFJAN // EIGHT WEEKS

16 Sep – Testing Complete. Move to Kuwait

28 Sep – Install Commences. Vehicles in ARIFJAN and authorized to issue

21 Oct – Installation Complete on (IOC)

E + 60 – Installation Complete on (FOC)

SITREP

- No change

NOTE:
 Acquisition = ADM(Mat)/PSPC Lead – FMS (Ongoing)
 Integration = CA/US DoS lead, _____ (Complete)
 Testing = CA/ADM(S&T) lead, _____ (Complete)
 Installation = DoS Lead, ARIFJAN (Upcoming)

15-1

TECH BRIEF & MEDIA VISIT UPDATE

- **Op IMPACT Tech Brief by MND / CDS**
 - **5 Oct Date is now cancelled**
 - **New Dates Pending**

- **Op IMPACT Media Visit: 10-14 Nov 16**
 - **12 Nov - 1 x Day at JTF-I HQ ASAB**
 - **13 Nov - 1 x Day at JTF-I Det Erbil**
 - **No Disruption to TF 66**
 - **3 x Media Agencies (6 Pers Total)**

VISITS

| AGENCY | WHO | WHERE | SEP | OCT | NOV | DEC | REMARKS |
|--------------------|--|----------------|---------|---------|---------|---------|----------------|
| CFJOSG (2) | Col Quinn CWO Martel | KUWAIT IRAQ | 21 - 24 | | | | |
| SHOW TOUR | Rotorhead Rebecca Noelle | KUWAIT | | 24 - 2 | | | Show = 29 Sep |
| PMO | TBC | TBC | | TBC | | | ▪ SJS / PCO |
| COMD RCAF (11) | D/M 5 x RCAF 5 x Hon Cols | KUWAIT | | 27 - 28 | | | |
| COMD (ME) | | | | 29 - 5 | | | |
| MEDIA (6) | 3 x Agencies | KUWAIT IRAQ | | | 10 - 14 | | |
| TCIT (4) | Col Cdr Lcol Cap | KUWAIT IRAQ | | | 19 - 21 | | |
| COMD (GULF) | | | | | | 1 - 9 | |
| COMD 1 CAD (10) | 1 CAD, 1 Wing, 2 Wing, 8 Wing, 14 Wing | KUWAIT IRAQ | | | | 7 - 8 | ▪ 5 x Comd Tms |
| SURG GEN (2-3) | Bgen MacKay CWO Colbert | KUWAIT IRAQ | | | | 22 - 26 | ▪ Over X-Mas |

NOTE:

- Comd JTF-I HLTA 21 Oct to 7 Nov 16

s.15(1)

Canadian Joint Operations Command

SECRET//



Commander's Weekly Update

OP IMPACT

28 September 2016

28 September 2016

Commandement des opérations interarmées du Canada

A0639440_3-004039

AGENDA

- **Personnel & Capability Update (J3 ME)**
- **CTAT Update (J3 ME)**
- **CTAT-J Projects (J5)**
- **Tac Avn Update (J3 ME)**
- **Role 2 Update (J3 ME)**
- **Erbil Camp Build Update (COS Sp)**
- **Public Affairs Update (PAO)**
- **Comd's Direction**

PERSONNEL AND CAPABILITY IN-FLOW

| | 1 Jun | 1 Jul | 1 Aug | 1 Sep | 1 Oct | 1 Nov | 1 Dec |
|----------------------|------------------|--|-----------------|------------------------------|----------------------|------------------------------|------------|
| JTF-I/HQ 53/1 | | | | | | | |
| FHT 9 | | | | | 11 (+2 Tm Mbrs) | | |
| MH 2 IOC FOC | | | | | | | |
| JTFSC 105/6 | | | | | | | |
| ATF-I 142/11 | | | | 150/11 (+8 ATF-I HQ) | | | |
| JTF-I Det Erbil | | | | 31 (HQ/JTFSC) 8 (Tac Avn) | 4 (R2B) 44 (+36) | 43 (R2B) 57 (+13 Tac Avn) | 49(+6 R2B) |
| ASIC 43/1 | | | | FOC | | | |
| Embeds 15 | | | 30 (new embeds) | | | | |
| MLT _{IOC} 5 | 8 (MLT Adv + FP) | 14 (Med, FP, Linguist, Clk) Zone Move | 20 (Int O, CP) | IOC 22 (+2 FP) | | 26 (+4 FP) | Zone Move |
| CTAT | | (13) LoE4 Recce 8-19 July | | 5 (CTAT-J 7 (+2 FP) | | 9 (+2 FP) | |
| | | | | | 6 (CTAT-L) 9 (+3 FP) | | |

154

| (Tac Avn Det) | 01 Jun | 18 Jun | 03 Jul | 28 Jul | 18 Aug | 01 Sep | 15 Sep | 03 Oct | 12 Oct | Nov |
|---------------|--------------|--------|--------|--------|---------------|--------|---------------|--------|--------|-----|
| | 506 | 537 | 543 | 558 | 569 | 616 | 626 | 653 | 701 | 809 |
| | 5 Jun 509 | | | | 11 Aug 564 | | 22 Sep 662 | | | |

- RECENT MILESTONES**
- Capability
 - Theatre Opening Team (On-Going)
 - R2B Erbil (CO/DCO) deploy 30 Sep
 - Authorities
 - Planning / Movements

- CIVILIANS IN JOA**
- Total =
 - HQ
 - ATF-I =
 - JTFSC
 - ASIC =
 - WoG/OGD :

- UPCOMING ACTIVITIES**
- Capability
 - MLT Vehicle
 - CTAT Lebanon
 - Tac Avn Det Deployment - 3xCH146/Remaining pers - 3 Oct
 - R2B Erbil (Advance party + on 11 Oct. Cold Chain on 12 Oct)
 - ASIC
 - Planning
 - Frag O 002 (Final Draft)
 - TO&E Change #10 (staff review)

CTAT UPDATE

CURRENT SITUATION

- CTAT-J is IOC
- CTAT-L
 - 29 Sep – Depart Canada
 - 4 Oct – Arrive Beirut

ISSUES

- CTAT-J
 - Accommodations

COORD

- Movt:
 - CONOPs approved by Comd JTF-I
 - CTAT
 - GZ 1 x Veh (2 pax)
 - RZ 2 x Veh (2 pax)
- PPE: _____ in go bag

C2

- OPCOM JTF-I
 - DSR and MOVECON
 - KLE & RSOMI
- Comms
 - CSNI/SVTC
 - DWAN
 - CAN BB and Local Cell
- Liaison
 - CJOC-J LNO
 - CDA JOR
 - ACDA LEB & Clerk
- ROE
 - ROEIMP (27 Sep)

IOC CRITERIA

- Team Lead and Team 2IC in HN & enabled to engage with HN military
- Establishment of unclassified & Level 2 communications (data & voice)
- Integral mobility within HN

FOC CRITERIA

- The entire CTAT deployed to HN
- Liaison established with HN counterparts
- Integral mobility with _____
- Delivery of first BPC activity

CTAT-L Visa / Passport Status

| | |
|--------------------|-----------------|
| Lead | PP & 90 Visa |
| SM | PP & 90 Visa |
| Int O (+Int O Tav) | PP & 90 Visa |
| Log O | Bearer's Letter |
| Sig | PP & 90 Visa |
| FP TL x 1 | PP & 90 Visa |
| FP x 3 | Depart 11 Oct |

SUPPORT

- Accn: Has compliant bidders
- Veh: Has compliant bidders
- LEP/RLS/ _____ Contracts will be done by deployed Log Os

CTAT ROAD TO FOC

| CRITERIA | CTAT-J | CTAT-L |
|-----------------------------|--------|--------|
| Entire CTAT deployed | | |
| Liaison established | | |
| Integral _____ | | |
| First BPC project delivered | | |
| STATUS | IOC | ----- |

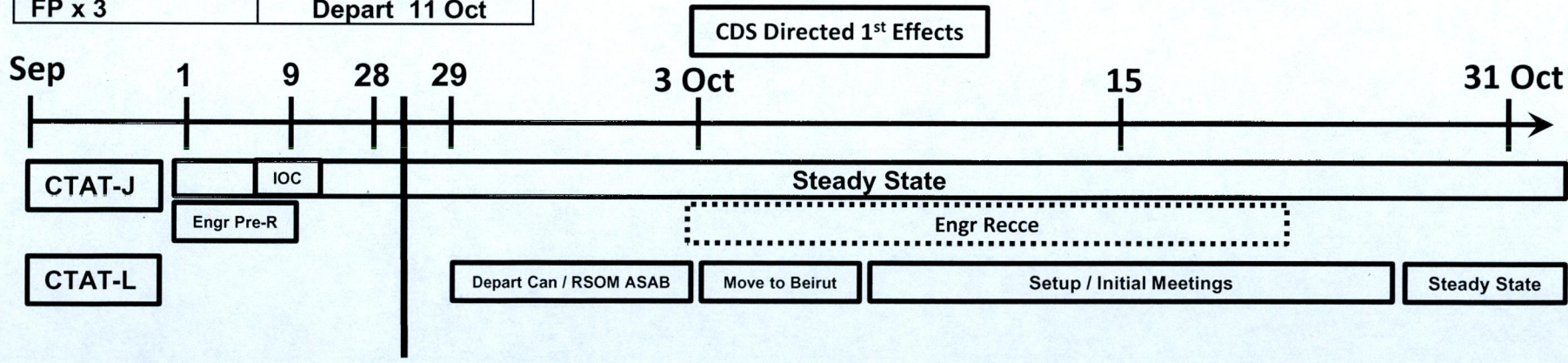

CTAT-J PROJECTS

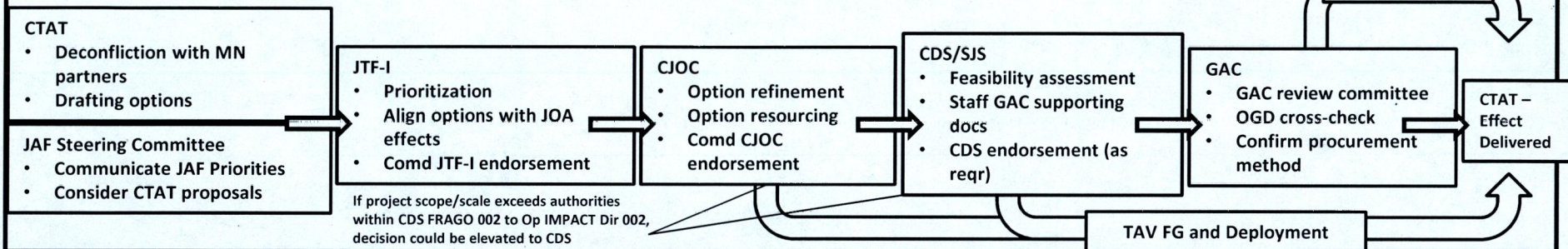

▲ = Colour denotes stage of progress
 ▲ = Tentative delivery
 ▲ = Effect delivered

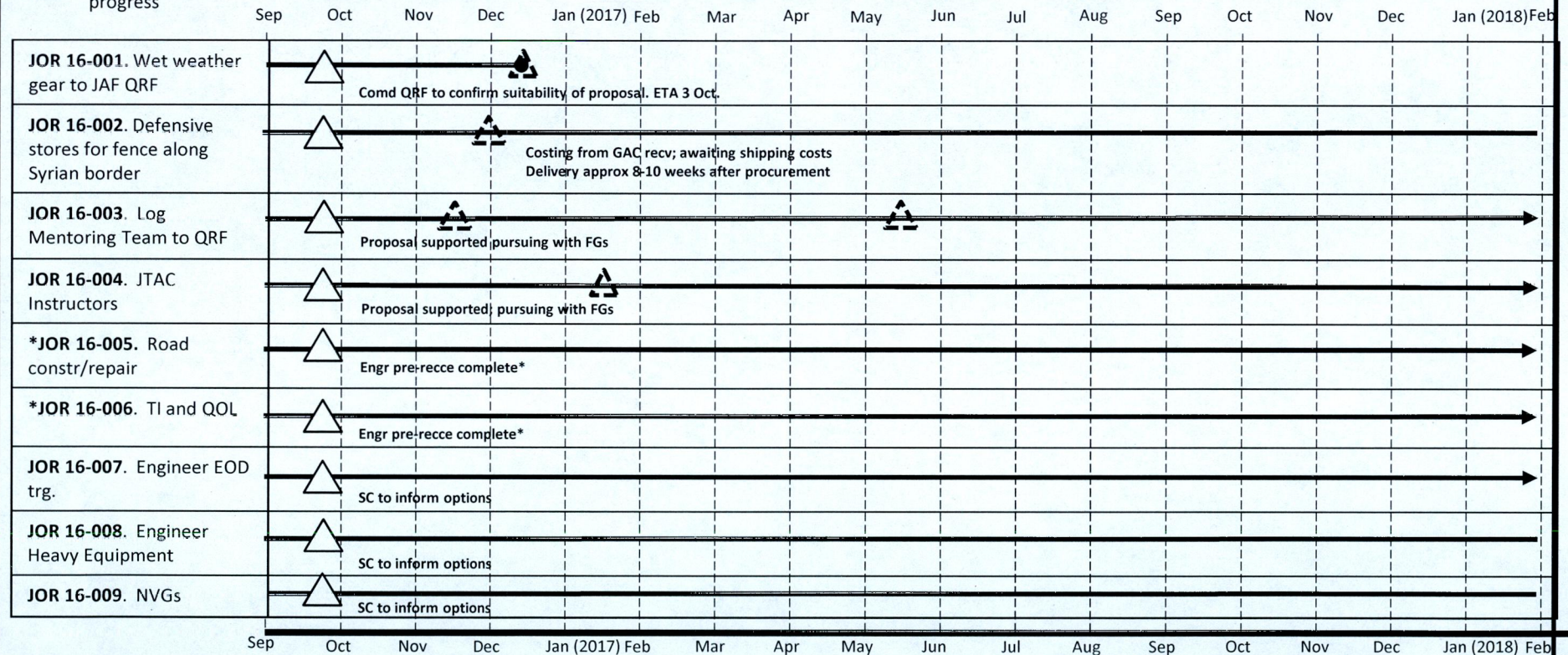

□ = Trg Project □ = Equip Project □ = Infrastructure Project

Full SC meeting anticipated week of 26 Sep 16

*JOR 16-005 – Road Constr/repair – Further coord occurring with GER through DA in AMMAN, GAC reviewing options.

*JOR 16-006 – TI/QOL Improvements – AUS has existing project; no funding. Investigating options for CAF to take them on.

TAC AVN RIP UPDATE

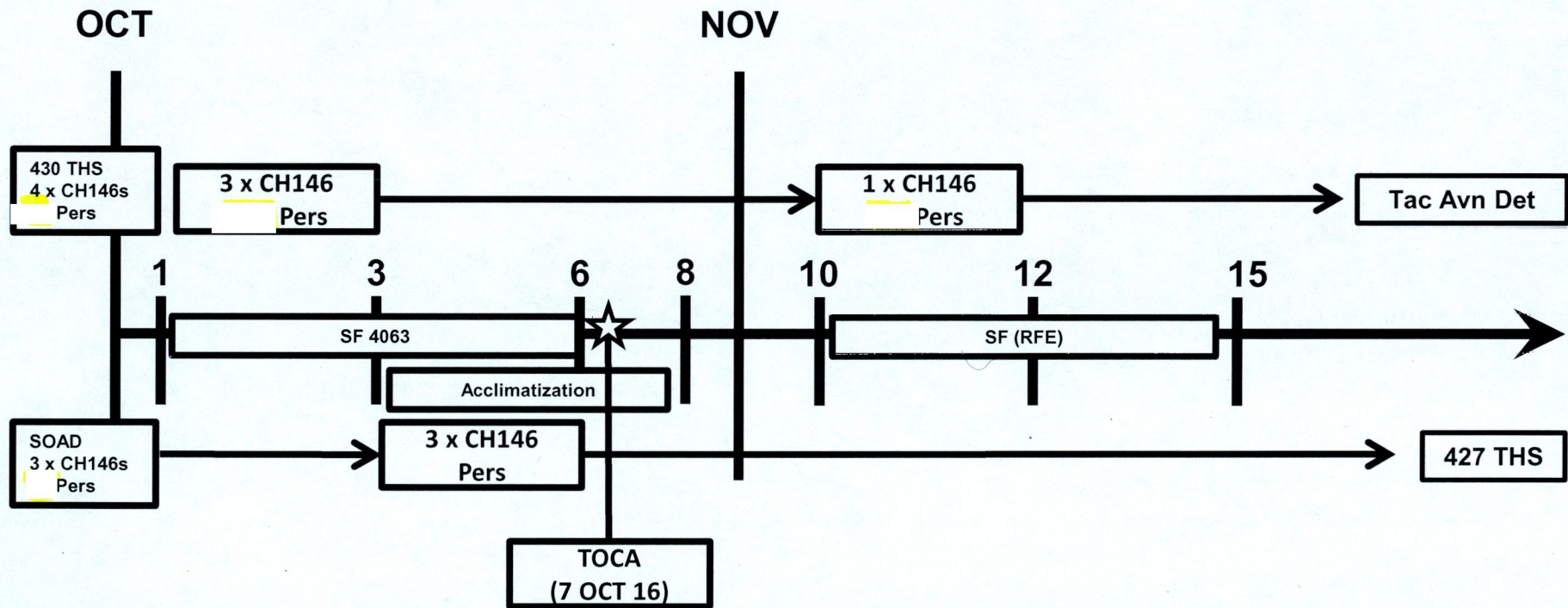

15(1)

ROLE 2 DEPLOYMENT PLAYBOOK

| SERIAL | VGD | ADV | IOC | FOC | FOC + | TOTAL |
|-----------|-----|---------|---------|-----|-------|-------|
| PERSONNEL | 4 | 14 (18) | 15 (33) | 10 | 6 | 49 |
| VISAs | 4 | 1 | 6 | 1 | 3 | 15 |

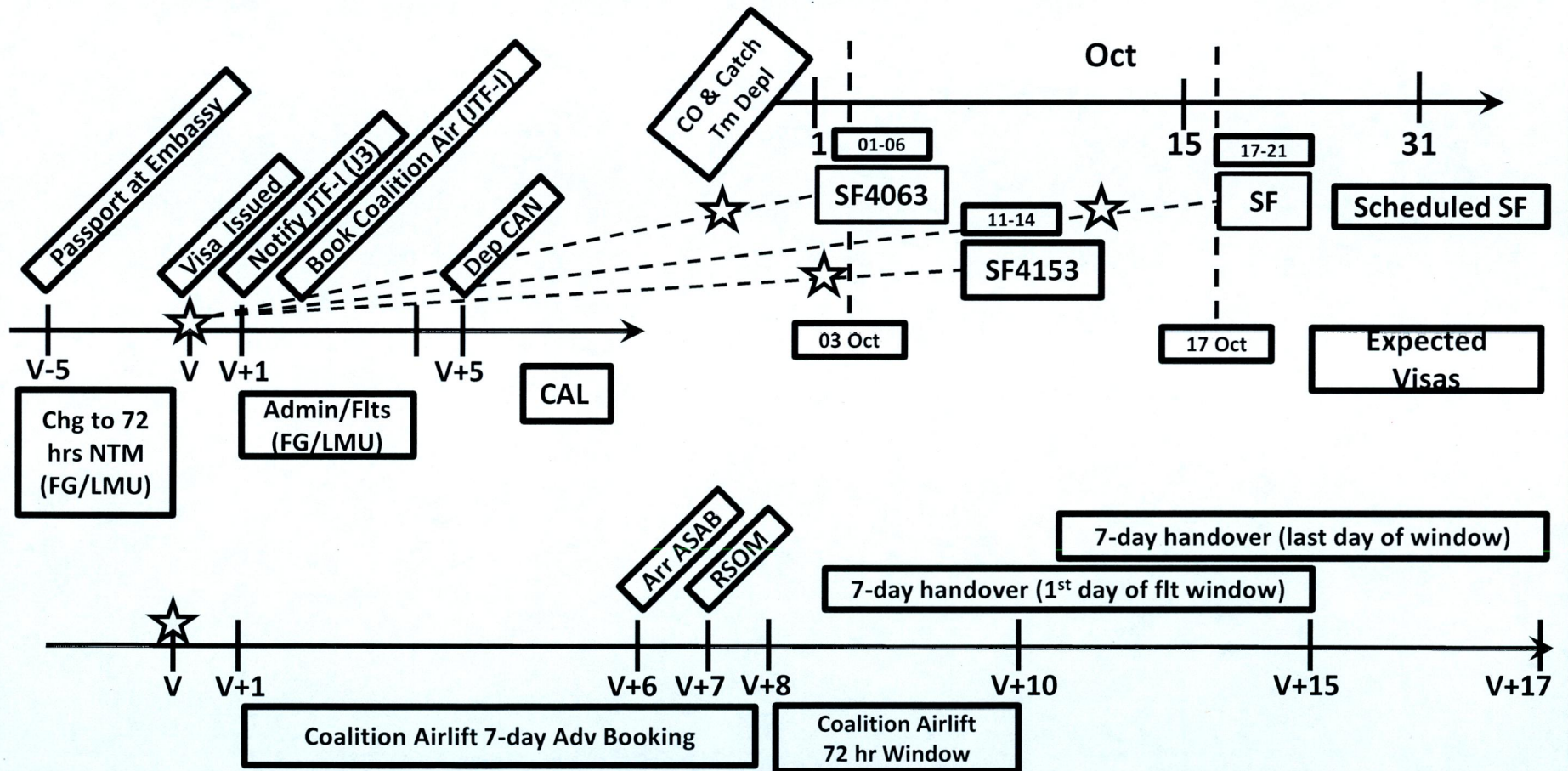

ERBIL CAPABILITY IN-FLOW

SITREP

- 2 x C130J and 1 x C17 RFEs submitted to mitigate Sep SF delays / cancellations
- 12 Oct – 1st window for cold chain movement

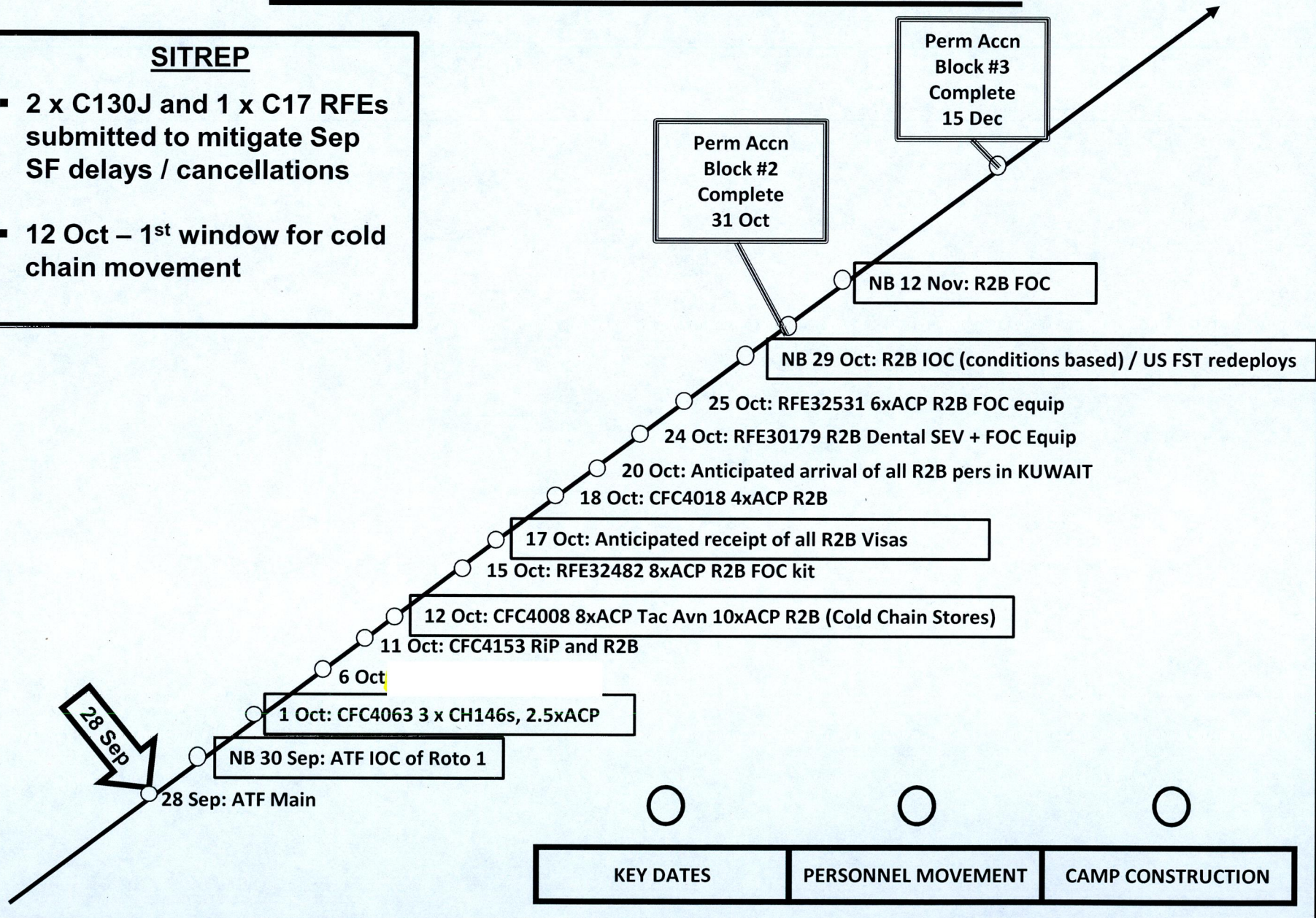

15-1

| | | |
|-----------|--------------------|-------------------|
| KEY DATES | PERSONNEL MOVEMENT | CAMP CONSTRUCTION |
|-----------|--------------------|-------------------|

PUBLIC AFFAIRS

- **MLT Director Media Engagement 5 Oct**
 - Agreed in principle if no new content vs previous media event
 - Coord with theatre for confirmation of content to be shared

- **Tech Brief: 6 Oct 1200-1300**
 - MND + CDS – statements and 20 minutes Q&As;
 - Comd CJOC + CANSOFCOM – statements and 20 minutes Q&As
 - Dry Run: 6 Oct 0800-0915; 4 spokespersons present; NDHQ

- **Media Visits: 10-13 Nov**
 - 10 Nov sust flight
 - 12 Nov JTF-I HQ visit
 - 13 Nov JTF-I Det Erbil visit
 - CBC, La Presse, Cogeco/Radio 98.5 (VISA status: 3/6 in 8 days)
 - PA escort to include 1 X PAO + 1 X Image Tech from Ottawa



Commander's Weekly Update

OP IMPACT

5 October 2016

AGENDA

- **Personnel & Capability Update (J3 ME)**
- **TO&E 10 Overview (J3 ME)**
- **CTAT Update (J3 ME)**
- **CTAT-J Projects (J5)**
- **Tac Avn Update (J3 ME)**
- **Role 2 Update (J3 ME)**
- **Erbil Camp Build Update (COS Sp)**
- **Comd's Direction**

PERSONNEL AND CAPABILITY IN-FLC

| | 1 Jun | 1 Jul | 1 Aug | 1 Sep | 1 Oct | 1 Nov | 1 Dec |
|-----------------|------------------|-----------------------------|-----------------|---------------|----------------------|---------------------|-------|
| JTF-I/HQ 53/1 | | | | | | | |
| FHT 9 | | | | | 11 (+2 Tm Mbrs) | | |
| MH 2 IOC FOC | | | | | | | |
| JTFSC 105/6 | | | | | | | |
| ATF-I 142/11 | | | | | 150/11 (+8 ATF-I HQ) | | |
| JTF-I Det Erbil | | | | 17 (HQ/JTFSC) | 4 (R2B) | 31 (+14 HQ/JTFSC) | |
| | | | | 8 (Tac Avn) | 44 (+36) | 43 (R2B) 49(+6 R2B) | |
| | | | | | 57 (+13 Tac Avn) | | |
| ASIC 43/1 | | | | | FOC | | |
| Embeds 15 | | | 30 (new embeds) | | 28 (-2 Aus R2E) | | |
| MLT 5 IOC | 8 (MLT Adv + FP) | 14 (Med, FP, Linguist, Clk) | 20 (Int O, CP) | 22 (IOC) | | 26 (Zone Move) | |
| | | one Move | | | | | |
| CTAT | | (13) LoE4 Recce 8-19 July | | 5 (CTAT-J) | 7 (+2 FP) | 9 (+2 FP) | |
| | | | | | | 6 (CTAT-L)9 (+3 FP) | |

154

| (1 ac Avn Det) | 01 Jun | 18 Jun | 03 Jul | 28 Jul | 18 Aug | 01 Sep | 15 Sep | 04 Oct | 12 Oct | Nov |
|----------------|--------|--------|--------|--------|--------|--------|--------|--------|--------|-----|
| | 506 | 537 | 543 | 558 | 569 | 602 | 612 | 637 | 799 | 807 |
| | 5 Jun | | | | 11 Aug | | 22 Sep | | | |
| | 509 | | | | 564 | | 648 | | | |

- RECENT MILESTONES**
- Capability
 - Theatre Opening Team (Redeploy has began)
 - CTAT Lebanon (4 Oct 16)
 - Tac Avn Det Deployment (4 Oct 16)
 - Authorities
 - Planning / Movements

- CIVILIANS IN JOA**
- Total =
 - HQ
 - ATF-I =
 - JTFSC
 - ASIC =
 - WoG/OGI

- UPCOMING ACTIVITIES**
- Capability
 - MLT Vehicle
 - R2B Erbil (Advance party + on 11 Oct, Cold Chain on 12 Oct)
 - ASIC
 - Planning
 - Frag O 002 (Final Draft)
 - TO&E Change #10 (Staff)
 - COS CJFLCC-I KLE (BGen Kelsey - 12 Oct)
 - Comd ATF-I (R4) KLE (Col Guillette - 19 Oct)

15-1

TO&E 10 OVERVIEW

| Element | Current (Change 9) | Proposed (Change 10) | New Position Details | JTF-I Comment / Substantiation | CJOC Staff Comment |
|-----------|---------------------------|------------------------------|------------------------------------|--|---|
| JTF-I HQ | | | BDSC Tfc Tech | Request at BDSC | Supported by staff |
| | | | J35-2 & J5-3 | Request to manage plans work | Not supported by J3 ME |
| ATF-I | | | | | Restricted 20 x Tac Avn positons |
| R2B | | | Directed in MC under LoO 3 | | |
| Det Erbil | | | Duty O & Ops NCO | Request to man 24/7 Ops | Not Supported by J3 ME |
| | | | Chaplain | Request for Erbil | Supported by COS Support |
| | | | Postal & Sup Tech | Request for Erbil | Supported by COS Support |
| | | | PH Tech & MSE Op | Request to maint facility & tpt | Not supported by COS Support |
| MLT | | | Sig Op | Request to maintain and man MLT CP | Supported by COS Support |
| JTFSC | | | Ammo tech | Request to compliantly pack and ship SA ammo | Supported by COS Support |
| | | | CMC | Request to manage contracts | Supported by COS Support |
| CTATs | | (+10) | FP each | | CJOC Directed |
| | | | Ops O each | Request to manage heavy workload | Not Supported by J3 ME Pre-Mature Assessment |
| FHT | | (+2) | Team members | | CANSOF Request - Approved |
| ASIC | | (=) | | | |
| Embeds | | | Australian Role 2E commitment (-2) | | |
| CJOC | (73 Under CDS Directive) | (+74) (1 Over CDS Directive) | | | (5 Under CDS Directive) |
| CANSOF | (Even with CDS Directive) | (=) | | | (Even with CDS Directive) |
| MISSION | (73 Under MC) | (+1 Over MC) | | | (Under MC) |

15(1)

CTAT UPDATE

CURRENT SITUATION

- CTAT-J is IOC
- CTAT-L
 - 4 Oct - Arrived in Beirut

ISSUES

- CTAT-J
 - Accommodations

COORD

- Movt:
 - CONOPs approved by Comd JTF-I
 - CTAT

C2

- OPCOM JTF-I
 - DSR and MOVECON
 - KLE & RSOMI
- Comms
 - CSNI/SVTC
 - DWAN
 - CAN BB and Local Cell
- Liaison
 - CJOC-J LNO
 - CDA JOR
 - ACDA LEB & Clerk
 - ROE
 - ROEIMP (27 Sep)

IOC CRITERIA

- Team Lead and Team 2IC in HN & enabled to engage with HN military
- Establishment of unclassified & Level 2 communications (data & voice)
- Integral mobility within HN

FOC CRITERIA

- The entire CTAT deployed to HN
- Liaison established with HN counterparts
- Integral mobility with
- Delivery of first BPC activity

CTAT ROAD TO FOC

| CRITERIA | CTAT-J | CTAT-L |
|-----------------------------|--------|--------|
| Entire CTAT deployed | | |
| Liaison established | | |
| Integral | | |
| First BPC project delivered | | |
| STATUS | IOC | ----- |

CTAT-L Visa / Passport Status

| | |
|--------------------|---------------|
| Lead | Deployed |
| SM | Deployed |
| Int O (+Int O Tav) | Deployed |
| Log O | Deployed |
| Sig | Deployed |
| FP TL x 1 | Deployed |
| FP x 3 | Depart 11 Oct |

SUPPORT

- Accn: Has compliant bidders
- Veh: Has compliant bidders
- LEP/RLS, Contracts will be done by deployed Log Os

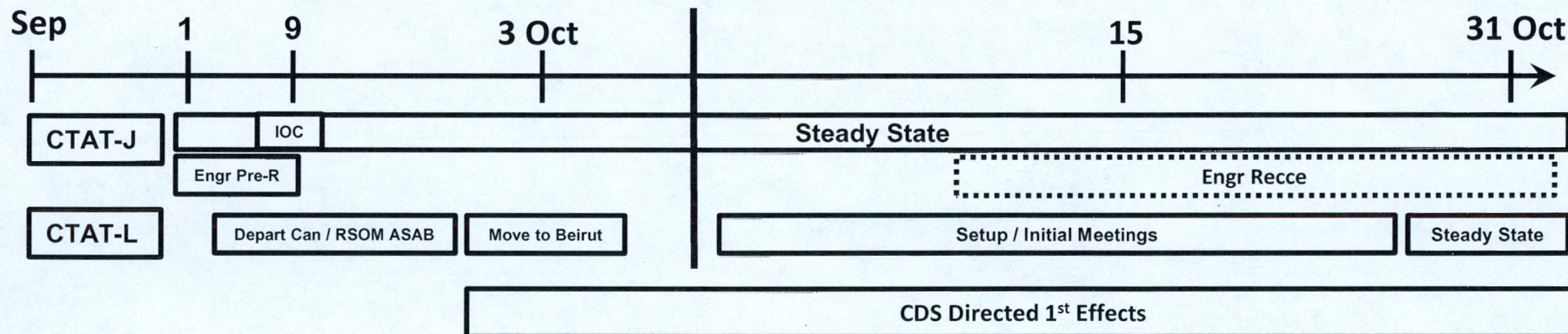

CTAT-J PROJECTS

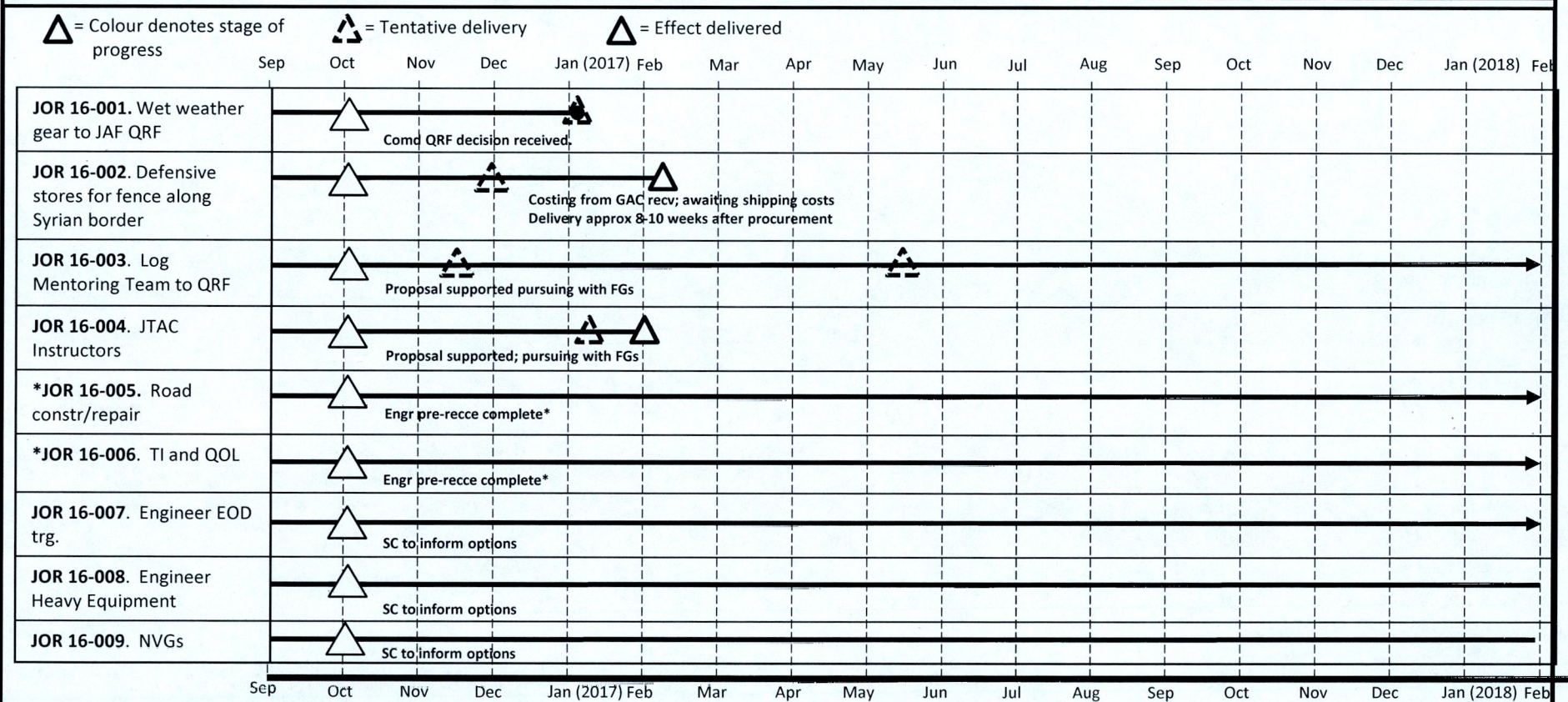
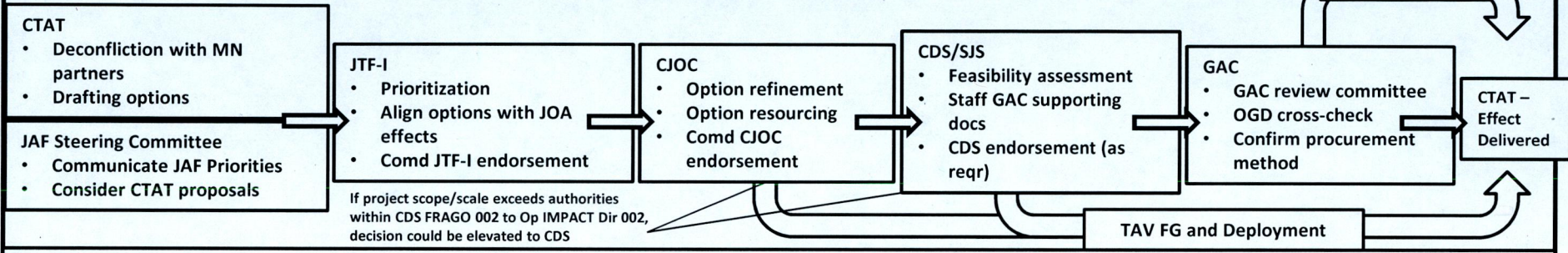

□ = Trg Project □ = Equip Project □ = Infrastructure Project

Full SC meeting anticipated week of 26 Sep 16
 *JOR 16-005 – Road Constr/repair – Further coord occurring with GER through DA in AMMAN, GAC reviewing options.
 *JOR 16-006 – TI/QOL Improvements – AUS has existing project; no funding. Investigating options for CAF to take them on.

TAC AVN RIP UPDATE

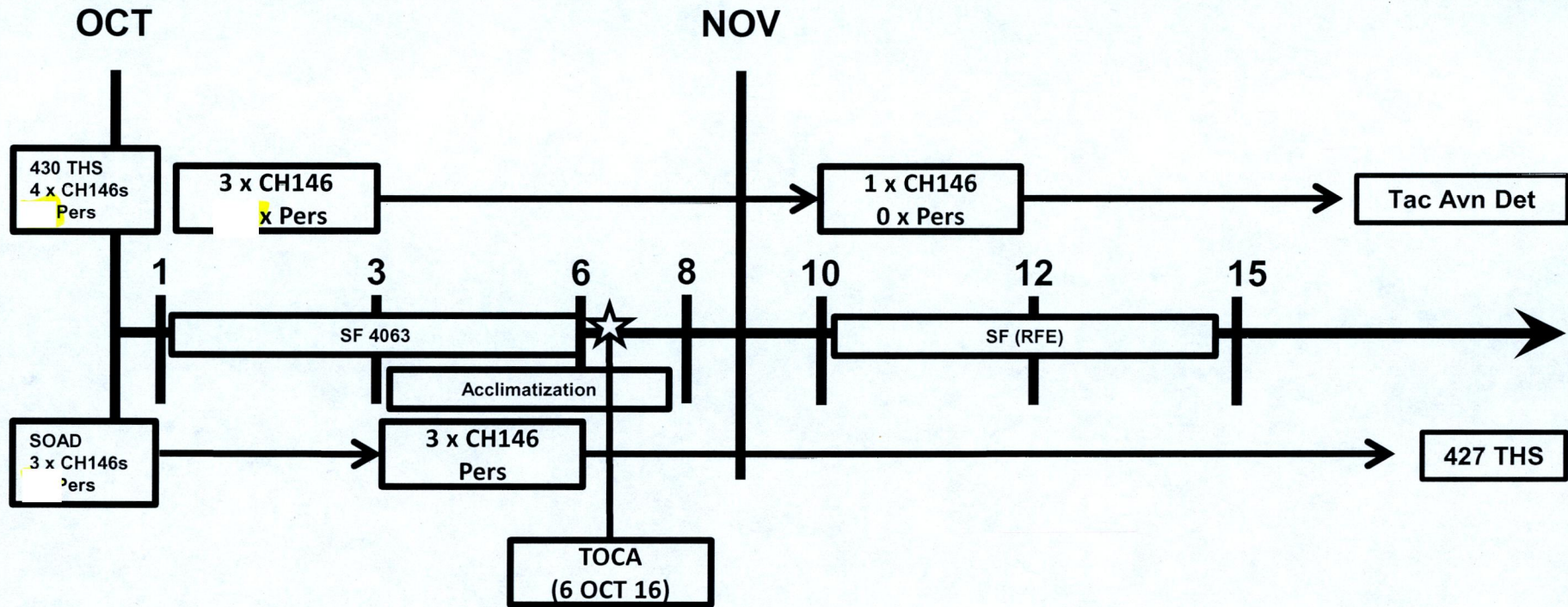

ROLE 2 DEPLOYMENT PLAYBOOK

| SERIAL | VGD | ADV | IOC | FOC | TOTAL |
|-----------|-----|---------|---------|-----|-------|
| PERSONNEL | 4 | 14 (18) | 15 (33) | 16 | 49 |
| VISAs | 4 | 4 | 8 | 11 | 27 |

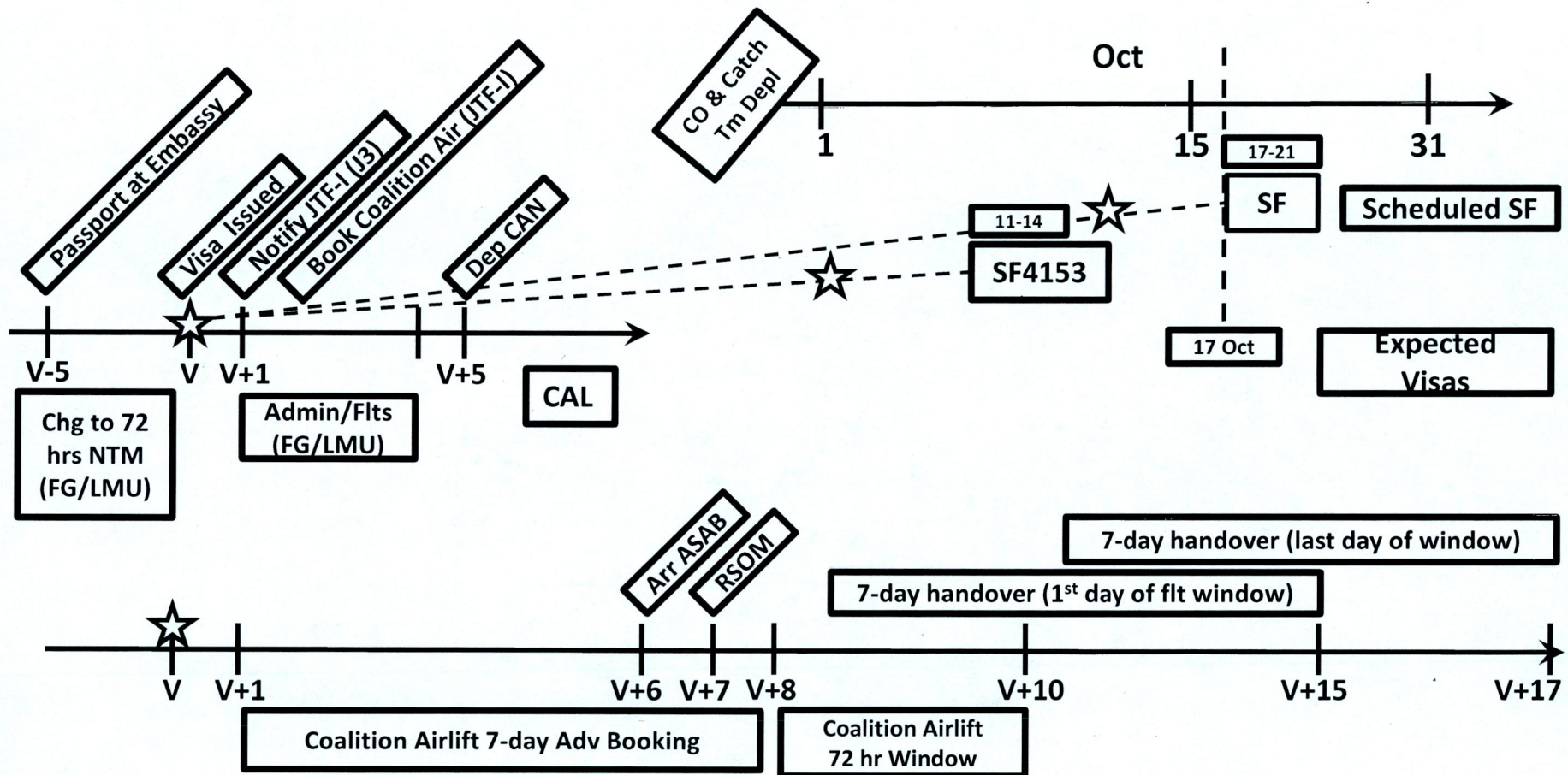

ERBIL CAPABILITY IN-FLOW

SITREP

- CFC4063 delayed 24 hrs

Perm Accn
Block #2
Complete
31 Oct

Perm Accn
Block #3
Complete
15 Dec

NB 12 Nov: R2B FOC

NB 29 Oct: R2B IOC (conditions based) / US FST redeploys

25 Oct: RFE32531 6xACP R2B FOC equip

24 Oct: RFE30179 R2B Dental SEV + FOC Equip

20 Oct: Anticipated arrival of all R2B pers in KUWAIT

18 Oct: CFC4018 4xACP R2B

17 Oct: Anticipated receipt of all R2B Visas

15 Oct: RFE32482 8xACP R2B FOC kit

12 Oct: CFC4008 8xACP Tac Avn 10xACP R2B (Cold Chain Stores)

11 Oct: CFC4153 RiP and R2B

6 Oct:

1 Oct: CFC4063 3 x CH146s, 2.5xACP

5 Oct

KEY DATES

PERSONNEL MOVEMENT

CAMP CONSTRUCTION



Commander's Weekly Update

OP IMPACT

12 October 2016

AGENDA

- **Personnel & Capability Update (J3 ME)**
- **CTAT Update (J3 ME)**
- **CTAT-J Projects (J5)**
- **Role 2 Update (J3 ME)**
- **Erbil Camp Build Update (COS Sp)**
- **Fall Visits Update (J3 ME)**
- **Comd's Direction**

PERSONNEL AND CAPABILITY IN-FLOW

| | 1 Jun | 1 Jul | 1 Aug | 1 Sep | 1 Oct | 1 Nov | 1 Dec |
|----------------------|------------------|--|-----------------|------------------------------|---------------------|----------------------------------|-----------------------------------|
| JTF-I/HQ 53/1 | | | | | | | |
| FHT 9 | | | | | 11 (+2 Tm Mbrs) | | |
| MH 2 IOC FOC | | | | | | | |
| JTFSC 105/6 | | | | | | | |
| ATF-I 142/11 | | | | 150/11 (+8 ATF-I HQ) | | | |
| JTF-I Det Erbil | | | | 17 (HQ/JTFSC) 8 (Tac Avn) | 4 (R2B) 44 (+36) | 28 (+24 R2B) 57 (+13 Tac Avn) | 31 (+14 HQ/JTFSC) 49 (+21 R2B) |
| ASIC 43/1 | | | | FOC | | | 1 (NZ IA) |
| Embeds 15 | | | 30 (new embeds) | | 28 (-2 Aus R2E) | | |
| MLT _{IOC} 5 | 8 (MLT Adv + FP) | 14 (Med, FP, Linguist, Clk) Zone Move | 20 (Int O, CP) | IOC 22 (+2 FP) | | 26 (+4 FP) | Zone Move |
| CTAT | | (13) LoE4 Recce 8-19 July | | 5 (CTAT-J) | 7 (+2 FP) | 9 (+2 FP) | |
| | | | | | 6 (CTAT-L) | 9 (+3 FP) | |

15-1

| (1 ac Avn Det) | 01 Jun | 18 Jun | 03 Jul | 28 Jul | 18 Aug | 01 Sep | 15 Sep | 04 Oct | 13 Oct | 1 Nov | ~15 Nov |
|----------------|--------|--------|--------|--------|--------|--------|--------|--------|--------|-------|---------|
| | 506 | 537 | 543 | 558 | 569 | 602 | 612 | 637 | 670 | 787 | 807 |
| 5 Jun | 509 | | | | 11 Aug | | 646 | | | | |
| | | | | | 564 | | | | | | |

- RECENT MILESTONES**
- Capability
 - Theatre Opening Team (Redeploy has began)
 - CTAT Lebanon
 - Tac Avn Det
 - Authorities
 - Frag O 002
 - Planning / Movements
 - COS CJFLCC-I KLE (BGen Kelsey - 12 Oct)

- CIVILIANS IN JOA**
- Total =
 - HQ =
 - ATF-I =
 - JTFSC =
 - ASIC =
 - WoG/OGD =

- UPCOMING ACTIVITIES**
- Capability
 - MLT Vehicle
 - R2B Erbil
 - ASIC
 - Planning
 - TO&E Change #10 (Final Coord with JTF-I)
 - Comd ATF-I (R4) KLE (Col Guillette - 19 Oct)

CTAT UPDATE

IOC CRITERIA

- Team Lead and Team 2IC in HN & enabled to engage with HN military
- Establishment of unclassified & Level 2 communications (data & voice)
- Integral mobility within HN

FOC CRITERIA

- The entire CTAT deployed to HN
- Liaison established with HN counterparts
- Integral mobility with
- Delivery of first BPC activity

CURRENT SITUATION / CURRENT CHALLENGES

- CTAT-J
- MND Visit
- Impact / Assessment of recent JAF GOFO changes
- CTAT-L
- Visas
- IOC

CTAT ROAD TO FOC

| CRITERIA | CTAT-J | CTAT-L |
|------------------------------------|------------|------------|
| Entire CTAT & FP Elements Deployed | 12 Oct | 12 Oct |
| HN Liaison established | | |
| Integral | | |
| First BPC project delivered | | |
| PRESENT STATUS | IOC | IOC |

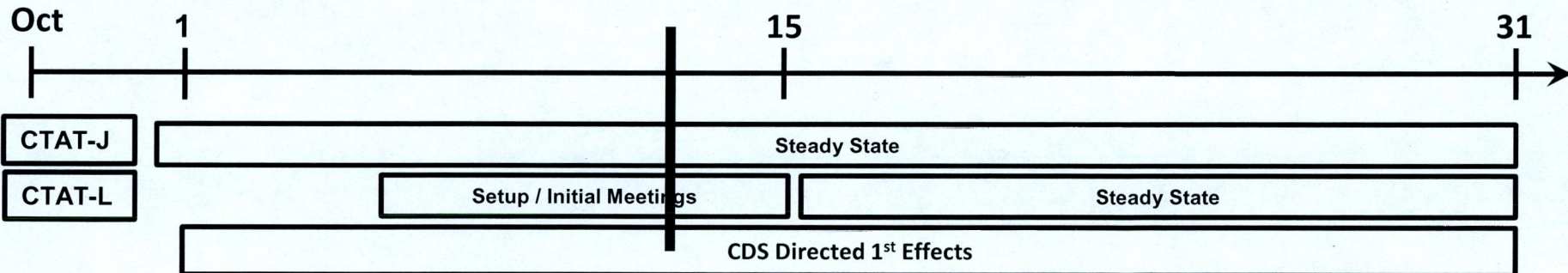

CTAT(J) Project tracker

| Project | JAF SC | CTAT | JTF-I | CJOC | CDS/SJS | GAC | CTAT Effect Delivered |
|---|--|---|------------------------------|--|--|--------------------------------|---|
| JOR 16-001Wet weather (JAF QRF) | Comd QRF approved | Proposal submitted | Supported | Approved | 4 Oct – GAC advised to action | Actioning | ETD 15 Dec 1200 sets |
| JOR 16-002 Defensive stores for Syrian border | | Proposal submitted | Supported | Approval pending on cost confirmation | 4 Oct – fwd to GAC for final costing | Developing final shipping cost | ETD 8 weeks from approval |
| JOR 16-003 Log Mentoring Team to QRF | 9 Oct CTAT(J) meeting with MGen Jaradat | Proposal submitted | Supported | TAV reqr for Nov trg event Army- COA refinement | N/A | N/A | Nov Trg Event Dates TBC Jan – mid 2018 ongoing MLT task |
| JOR 16-004 JTAC Instructors | <u>Rd Priority</u> 1. Tower | Proposal submitted | Supported | Army support rec'd | N/A | N/A | JTAC crse 15 Jan – 6 Mar |
| JOR 16-005 Road constr/repair | <u>TI Priority</u> 1. Tower | Waiting on priority clarity from JAF SC | Initial concept supported | DCC engaged BN to follow | DCC Cost Estimate | | TBD |
| JOR 16-006 TI and QOL | <u>QOL Priority</u> 1. Solar Power Generators | Engaged AUS ref QoL initiatives Waiting on SC | Initial concept supported | Recce staff check completed. All avail less survey | Engr Recce (Not Before Current Date + 28 Days) | | TBD |
| JOR 16-007 Engineer EOD trg. | 2. HESCO fortifications | Proposal submitted | Supported | Recce staff check complete | | | TBD |
| JOR 16-008 Engineer Heavy Equipment | 3. Searchlights & Portable Accommodati on | Waiting on JAF SC | No formal proposal submitted | Initial estimate conducted, recce recommended | | | TBD |
| JOR 16-009 NVGs | Note: MGen Jaradat has been asked to retire and TSC make-up expected to change | May not be reqr – based on US MAP, Trg option TBC | | | | | TBD |

15-1

= Trg Project = Equip Project = Infrastructure Project