

**Pages 3867 to / à 3868
are withheld pursuant to section
sont retenues en vertu de l'article**

15(1)

**of the Access to Information Act
de la Loi sur l'accès à l'information**

SECRET

Office of the Commander
Air Task Force – Iraq
Op IMPACT



Cabinet du Commandant
Force Opérationnelle Aérienne – Iraq
Op IMPACT

**BRIEFING NOTE FOR COMD JTF-I
THIRD LOCATION DECOMPRESSION
FOR TACTICAL AVIATION DETACHMENT**

Reference: Briefing Note to ATF-I for JTF-I Support. Issue: Third Location Decompression (TLD) for members of the Tac Avn Det

AIM

1. To request a Third Location Decompression (TLD) for the Tactical Aviation Detachment (Tac Avn Det).

BACKGROUND

2. The Tac Avn Det arrived in Erbil on 21 September 2016, replacing 427 SOA. Their operational tempo from the start of their deployment has been intense. They have conducted operations daily since their arrival and have met all tasked missions. They are expected to fly throughout the day and night in areas

15-1

3. The Tac Avn Det's assigned taskings are Tactical Airlift, Command and Liaison (C&L) and CASEVAC in-extremis. They conduct re-supply and mobility missions in support and the in areas which places an inordinate amount of stress on the aircrew. The Tac Avn Det mission has proven to be risky and challenging due to flying and landing close in an evolving and dangerous environment. These are the inherent risks associated with their mission, however, even back at the camp the Tac Avn members are not able to. Camp Erable is located in a low risk area but is still only. The ops tempo combined with the mere thought of constantly being have had emotional and psychological effects on these members.

DISCUSSION

4. The current location for the Tac Avn Det members to decompress is Erbil, which is also their operational working area. This practice does not meet the TLD reintegration program's objective, due to the fact that members are still in the same stressful

SECRET

SECRET

environment. The unit has flown 71 missions, have carried 21,565 lbs of cargo, and 470 passengers from 6 October 2016 Oct to present, typically flying up to _____ day period, which has been an extraordinary challenge. When returning from these long missions, it is imperative that the crews have adequate rest and relaxation; however, they often suffer from day and night fatigue. Erbil does not provide a suitable environment to unwind following this high operational tempo. Furthermore, the transition phase, at the end of the deployment, is not conducted in a structured environment to allow members to prepare themselves to return to a normal life when they arrive back in Canada. The transition from the deployed environment to the home environment represents an enormous change for those members who are away from home for a long period of time and can present challenges, both mentally and physically, if not done properly.

15(1)

5. Elongated periods of time in a threatening and perilous environment, such as Erbil, the KDL near Mosul, and Baghdad, indubitably elevates stress levels for the Tac Avn Det members and support elements. Their mission is conducted in an unpredictable environment, where potential attacks may arise at any time. This risk of attacks is a stress factor that members are confronted with daily.

6. Attacks on Kirkuk and Sulamaniyah have had a psychological impact on the Tac Avn Det, because similar events could be repeated in Erbil. To maximize protection for the Tac Avn Det, all members must remain in a _____ The members of the Tac Avn Det are thus _____ for the whole deployment which is not conducive to proper rest and relaxation.

15(1)

7. Although technology has allowed members to communicate back home with friends and family, these members are exposed to Espionage. These threats impact the security of infrastructure, unclassified computer systems, and personal family communication (through the use of internet or telephone services).

8. Members of this (Tac Avn Det) rotation were also part of the pre-deployment to Erbil. The laborious planning cycles that have been experienced with members deploying on very short notice has added stress to the mission and reduced the rest and refit time for the air and ground crews. As well, the time spent conducting aircraft preparation and readiness for the mission before leaving Canada contributed to a more demanding deployment.

CONCLUSION

9. Erbil, Iraq is not an ideal location for a TLD for the Tac Avn Det who is facing constant stress in a high op tempo and danger zone. An acceptable time for a TLD would be a minimum of three days outside Erbil. These members will have completed four to six months of high op tempo in a medium to low threat environment. This would

SECRET

enable them to make a smooth transition into normal daily life. More importantly, time away from the high op tempo will give them enough time to recover from this demanding mission. Finally, this will also enable them to receive formal training and education on R2MR to address any potential issues/problems they may face upon returning home.

RECOMMENDATION

10. It is recommended that Tac Avn Det members have a TLD phase outside the proximity of Erbil.

Prepared By: Maj [redacted] - I A1
Reviewed By: LCol [redacted] Tac Avn Det CO
Reviewed By: LCol [redacted] ATF-I DComd
Reviewed By: Col [redacted] Comd ATF-I
Prepared For: BGen S. Brennan, Comd JTF-I

17

Date prepared: 2 December 2016

SECRET

s.15(1)

SECRET//

COMMANDER
1 CANADIAN AIR DIVISION



COMMANDANT DE LA
1^{re} DIVISION AÉRIENNE DU CANADA

19 December 2016

Comd CJOC

OPERATION (OP) IMPACT – AMENDMENT TO BN ON
EMPLOYMENT OF THE CP140

References: A. Briefing Note for the CDS: Op IMPACT – EMPLOYMENT OF THE
CP140 8 December 2016

B. CDS Letter to Comd CJOC: Op IMPACT EMPLOYMENT OF THE CP140
15 December 2016

C. BN for Comd CJOC: OPERATION (OP) IMPACT – AMENDMENT TO
EMPLOYMENT OF THE CP140

15-1

1. I support the recommendations found in the enclosed Briefing Note to amend the caveat in reference A, to ensure that we continue to meet the CDS direction while providing the Commander Joint Task Force - Iraq operational flexibility to meet its objectives.

2. For your consideration,

J.H.C. Drouin
Major-General

SECRET//

SECRET//

3350-Op IMPACT (JFACC)

BRIEFING NOTE FOR THE COMD CJOC

15-1

OP IMPACT - AMENDMENT TO BN ON EMPLOYMENT OF THE CP140

References: A. Briefing Note for the CDS Op IMPACT: EMPLOYMENT OF THE CP140
8 December 2016

B. CDS Letter to Comd CJOC: Op IMPACT EMPLOYMENT OF THE CP140
15 December 2016

ISSUE

1. Chief of the Defence Staff (CDS) approval is sought to amend the caveats at reference A for the expansion of CP140 operations into

BACKGROUND

2. At reference A, Commander (Comd) CJOC requested authority for the CP140 to operate with caveats. The CDS approved this request at reference B. This BN intends to re-word and clarify the caveats to better reflect the operational situation

DISCUSSION

3. CP140 operations in Operations Areas (OA) was approved with the following caveats:

- a. The minimum operating will be set at
- b. Continuous will be provided during all operations conducted in as is
- c. must be provided during the
- d. Comd 1 Canadian Air Division (1 CAD)/Joint Forces Air Component Commander must review and approve the CP140 Mission Acceptance and Launch Authority (MALA) prior to the commencement of CP140 operations. Subsequently, all CP140 missions must be approved by Comd ATF-I; and
- e. The of operations shall not lead to an for ISR support beyond the current commitment.

SECRET//

15(1)

SECRET// [redacted]

4. Caveat in paragraph 3.b requires to be amended, because the [redacted]

13-1

[redacted] is available through [redacted] located in [redacted]. The CRCs offer [redacted] services similar to [redacted] and are deemed appropriate to meet the intent of this caveat.

15-1

5. Clarification to the caveat in paragraph 3.c. is required as there is [redacted]

17-1

and [redacted] Conversely, there is a [redacted] aircraft [redacted] that are available to [redacted] These [redacted] are capable of providing effective [redacted] to the CP140 while operating [redacted]

15-1

RECOMMENDATION

6. It is recommended that CDS approval be granted for the operation of the CP140 [redacted] with the amended caveat (in italic) and clarification:

- a. The [redacted] will be set at [redacted]
- b. Continuous [redacted] support be provided during all operations conducted [redacted] as is standard operating procedure [redacted]
- c. [redacted] must be provided during the [redacted]
- d. Comd 1 Canadian Air Division (1 CAD)/Joint Forces Air Component Commander must review and approve the CP140 Mission Acceptance and Launch Authority (MALA) prior to the commencement of CP140 operations [redacted]. Subsequently, all CP140 missions [redacted] must be approved by Comd ATF-I; and
- e. The [redacted] of operations i [redacted] shall not lead to an [redacted] for ISR support beyond the current commitment.

Prepared By:	Maj [redacted]	1 CAD A3/CAOC Strat Div, 257-6790
Reviewed By:	LCol [redacted]	1 CAD A3/CAOC Dir, 257-5574
Reviewed By:	MGen [redacted]	Comd 1 CAD/JFACC, 257-5368
Reviewed By:	Col M.S. [redacted]	JFACC LO, 998-4043
Responsible Branch Head:	Col R.T. [redacted]	CJOC J3, 945-2324
Responsible COS:	BGen F.J. [redacted]	CJOC DCOS Ops, 998-4038
Responsible L1:	MGen W.F. Seymour,	A/Comd CJOC, 945-2299
Date Prepared:	19 December 2016	

17

SECRET// [redacted]

UNCLASSIFIED

BRIEFING NOTE FOR CJOC J3 (via Comd JTF-I)

CANADIAN TRAINING AND ASSISTANCE TEAM – LEBANON (CTAT-L)
TEAM COMPOSITION

- Refs: A. JTF-I OP ORDER – Build Partner Capacity in Jordan and Lebanon, 23 Sep 2016.
B. CJOC TASKING ORDER - Canadian Training and Assessment Team, Build Partner Capacity in Jordan and Lebanon, 31 Aug 2016.
C. CTAT-L weekly slide for the JTF-I CUB, various dates Nov 2016.
D. CTAT-L Weekly Situation Report to JTF-I, various dates Nov 2016.
E. E-mail traffic: Maj Quinlan (CJOC J3 ME-2) /LCol Tyler (CTAT-L Lead) 17 Nov 2016.
F. Meeting: BG Aoude (LAF Director Training)/LCol Tyler (CTAT-L Lead) 01 Nov 2016.
G. CTAT-L Project Proposal LEB16003 dated 30 Oct 16 (LAF CIMIC Mentoring).

ISSUE

1. Due to the nature of a Roto 0, aspects of an op will require validation, including team composition. This briefing note proposes manning adjustments to the CTAT-L core Team, and suggests a likely evolution of the core CTAT-L Team as the mission evolves.

BACKGROUND

2. IAW Ref A, within 30 days of reporting initial operating capability (IOC), CTAT-L was to make any recommended changes to Team manning. IAW Ref B, this is to be pushed within 60 days. CTAT-L arrived in Beirut on 2 Oct 2016 and reported IOC on 10 Oct 2016. At refs C and D CTAT-L reported the need for an Ops O / Projects O; as the volume of routine staff work (DSR, WSR, CONOP requests) and the work for requesting a CTCBP project was greater than anticipated. Currently the Team SM (a MWO) is assigned some “Ops Capt” duties (DSRs, CONOP requests), and the Lead (a LCol) does most of the remainder (WSR, project proposals). As per Ref E, for Roto 1 starting in Apr 17, a CTAT-L Ops O position will be added; concurrently a TAV Jan-Apr 17 is in CFTPO to assist with this shortfall sooner, but as per Ref E may not be filled.
3. TOE Planning Jun 16. During a meeting in Ottawa the CTAT leads and CJOC staff developed an initial recommended ORBATs of Team Lead, Team Sgt Maj, J2, J4 Log O, J6 NCO, and J2 Int O or NCO. Prior to publishing CFTPO tasks in July 2016, four drivers / Force Protection (FP) personnel were added to each team. Team leads were told that after a month they were to make recommendations as to what the steady-state core team composition should be, but not to exceed 15 personnel in total per team.

DISCUSSION

4. Evolution of the CTAT-L Mission. During the Roto 0 start up, there is a requirement for certain staff work that will be reduced or not required at all in future rotos. The mission is currently set for three years, with a possibility of extension. Regarding the training TAVs aspect of the mission, it is anticipated that (as per Ref F), for a course that the CAF may bring to the to LAF, for example Basic Winter Warfare, initially CAF instructors will be involved in delivering the instruction, then over time LAF instructors will deliver the training with perhaps a few CAF mentors available to consult. Work at each phase of the mission will vary:

UNCLASSIFIED

- a. Ph 1 – Start Up / Roto 0. During this phase in all functional areas there were recesses to be done and procedures to be established. There was a large requirement for work on the part of the Team’s Lead, J2, and J4, to establish relationships. The Lead has been very busy defining and staffing project proposals, and with routine Ops O work. The J4 is heavily involved in setting up real life support contracts (accommodation, vehicles, etc.); soon he will have most contracts in place, and he will be able to help with proposal staffing. The J6 and J3 Force Protection (FP) pers (x four) have had a steady workload with the odd very busy day; the J3 FP sgt is also employed with staff work drafting SOPs and research in support of project proposals. Due to lack of an Ops O the Team SM has been busy helping to fill that gap.
- b. Ph 2 – Steady State / Roto 1-4 (+/-). During Roto 1 (Apr-Sep 2017) project proposal identification and staffing will still involve significant work; whereas by Roto 2 there should be much less of such work. As training TAVs start (Roto 2 onward) there will be new work for the Team J4 and Team SM to coordinate real life support and TAV member pre-deployment training.
- c. Ph 3 – Draw Down / Roto 5 (+/-). This phase may see a complete withdrawal of the CTATs, or transition to a very small team such as a LCol and a Snr NCO who maintain relationships with relevant LAF leaders, support TAVs, and implement final equipping projects. A final small team of two could be supported administratively from outside of Lebanon, might still be stand-alone from the Embassy, or embedded there. If the latter then the CTAT-L duties could be passed to the Assistant Attaché (Asst CDA) if that position is created.

5. The table below of existing and proposed CTAT-L core members summarizes the Phase 1 and Phase 2 situation:

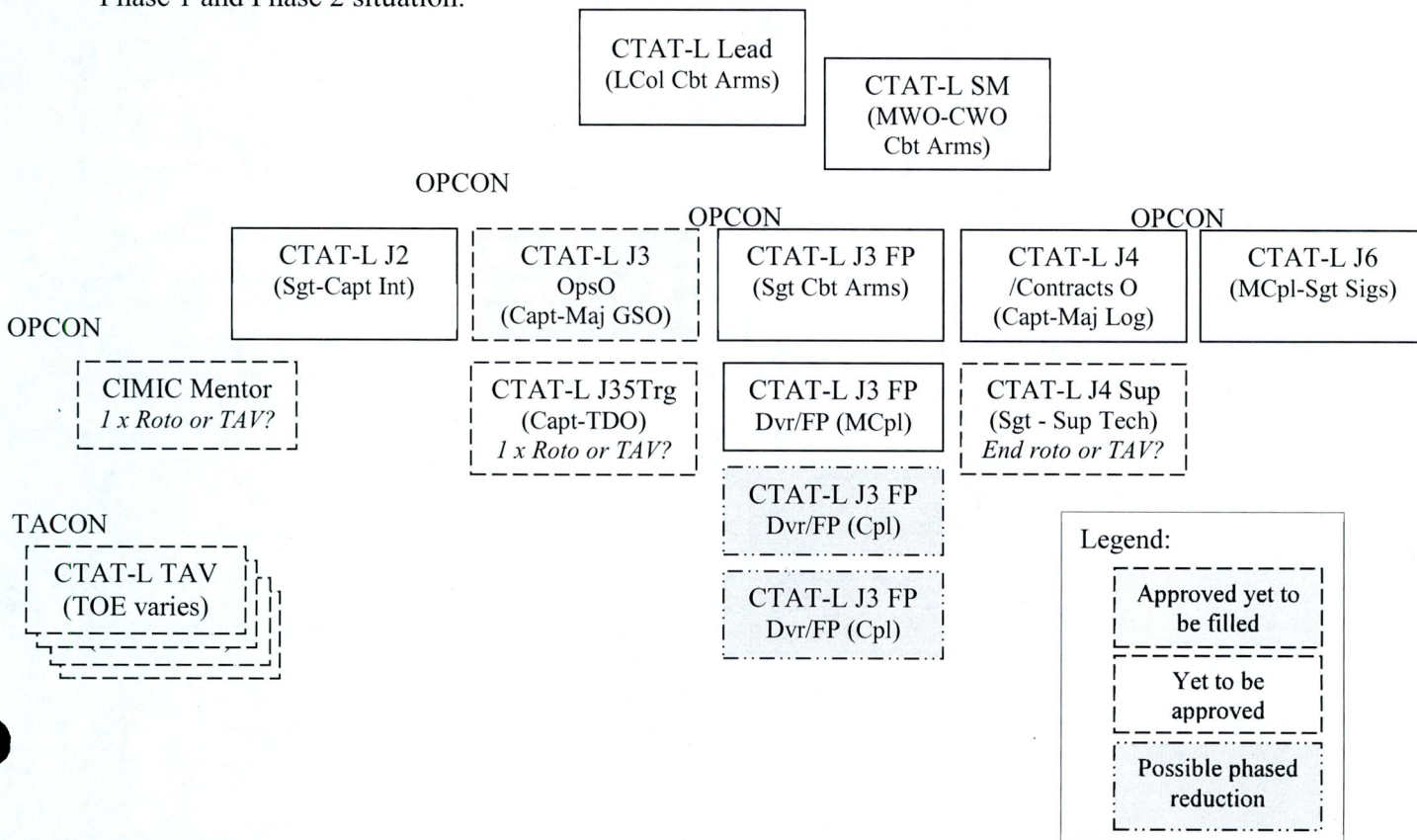

s.17

UNCLASSIFIED

6. Other Factors.
- a. Equipping vs Training Focus. At this stage it is still not fully clear what the balance of CTAT-L projects will be, equipping vs training. The balance may end up more weighted to equipping, given what the US, UK and others are doing, and the few gaps that exist for assisting the LAF; and given that the LAF who are heavily deployed operations around the country have some constraints on freeing up troops for training.
 - b. Team FP. Consideration could be given to transition options for a smaller CTAT-L footprint, such as self-driving and when needed employing Embassy-vetted local national drivers. CTAT-L Roto 0 has four mature soldiers; given the expansion of CAF missions around the globe there may be challenges to fill future rotos with the same calibre of soldiers; if this were the case CTAT-L could reduce to two J3 FP pers (ASUV qualified). Other factors to consider in the decision is whether a CAF-LAF Technical Agreement gets signed and protections (if any) therein; and the threats and hazards in Lebanon vis-à-vis other Mid East locations. If reducing CTAT-L's FP to two or three vice four, consideration must be given to qualifying one or two core Team members ASUV.
 - c. Ranks of each position. Being a small team the experience and maturity of each of the "one-of" positions must be high; for Roto 0 this has proved to be the case. For the J2, the analysis, relationships and reporting requirements necessitate sgt or above experience. The J3 FP Section Comd with secondary duties of Ops NCO needs sgt level experience. The Team SM is truly the LCol's comd team partner; were a future roto to be filled with a sgt or WO, the experience needed to perform this role in the team may not be present.
 - d. LAF Mentor TAVs embedded with core Team. A project proposal (Ref G) for a part-time CAF mentor at the LAF CIMIC Directorate if approved may see an officer living at the Team House for three or four months and commuting to the Directorate every 2nd day, while working as a Team staff officer on the other days. This may be a model in one or two other areas of the LAF such as at the Officer Academy or at MOD.

CONCLUSIONS AND RECOMMENDATION

7. There is a strong need for a CTAT-L "Operations & Projects Officer" position; currently this will be filled in Roto 1 starting in Apr 17; it might be met as early as 10 Jan 17 if a suitable person is found for a 3-month TAV. CTAT-L is functioning fine with four J3 FP pers, but could manage with two or three such pers if Army force generation pressures make it difficult to fill future rotos with individuals who are not of above-average maturity. Several additional facts were presented that will serve to inform future roto and TAV planning as the CTAT-L mission evolves, including eventual draw down to a small team or an Asst CDA that will complete the mission and continue the CAF-LAF relationship.

8. The only recommendation requiring immediate action is that the CTAT-L Ops O position TAV, for 10 Jan -10 Apr 17, be filled.

Prepared By: LCol
Approved By: LCol
Date: 20 Nov 2017

CTAT-L Lead
CTAT-L Lead

SECRET

15(1)

**BRIEFING NOTE FOR COMD JTF-I ON
ATF-I TAC AVN DET**

15-1

- Refs: A. Comd CJOC Direction and Guidance letter to Comd ATF-I - Oct 2016
- B. CJOC FRAGO 004 to OP ORDER 003, Annex H Air operations – OP IMPACT - 23 Dec 16
- C. Tac Avn CONOPS Revision 1 - 14 Dec 2016.
- D. ATF-I CH146 Mission Acceptance Approval Form - Version 3.7, 14 Dec 2016
- E. Transfer of Command Authority (TOCA) Operation Impact - 17 Nov 16
- F. 1 Wing FRAGO - Op IMPACT Nov 2016

AIM

- 1. To provide Comd JTF-I with an update on Tac Avn [redacted] and to seek direction and guidance on appropriate allocation and use of Tac Avn resources [redacted]

ISSUE

- 2. IAW Ref A, Comd JTF-I and Comd ATF-I are responsible for the YFR management and mission acceptance for the Tac Avn Det [redacted] within Aircraft Type Authorized Mission Sets (ATAMS). The baseline level of Tac Avn support for Op IMPACT is one Line Of Task (LOT), up to seven days a week, consisting of 2 X CH146 (Ref B). Since the offensive on Mosul began, the demand for [redacted] however, there has been an increase in Request For Effect (RFE) to support [redacted] Consequently, Comd JTF-I and Comd ATF-I have been providing command oversight over the [redacted] through Refs C&D whenever Tac Avn support to the coalition is requested. As a result, in order to fly the allocated OP IMPACT YFR at Ref B, a greater portion of the CH146 YFR has been used to support [redacted]

BACKGROUND

- 3. [redacted] however, IAW Ref C, the [redacted] for the Tac Avn Det in [redacted] has remained static – no further than [redacted] dated Aug 2016. Of note, [redacted] in the operating area – [redacted] – are [redacted] being [redacted] As a result, the Tac Avn Det has had a [redacted] in aircraft and YFR to support [redacted] Comds JTF-I and ATF-I continue to provide command and control oversight through the Mission Acceptance process to manage Tac Avn resources in [redacted] This process ensures that any additional LOT can be properly prioritized and allocated to support operations. A Tac Avn LOT is a dedicated mission, within the constraints of the TOCA (Ref E), to [redacted] 2nd LOT is a dedicated mission to support an [redacted] that will occur concurrent to the first LOT.

SECRET

SECRET

4. Main factors to consider when determining the appropriate allocation of Tac Avn resources to [redacted] per the TOCA include:

15-1

- a. Number of [redacted]
- b. Proportion of missions conducted in direct [redacted]
- c. Average aircraft serviceability rate; and
- d. YFR expenditure.

DISCUSSION

5. In Nov 2016, the Tac Avn Det airlifted 255 passengers. Of these, [redacted] From 1-28 Dec 2016, the Tac Avn Det transported 222 passengers. Of these, 155 [redacted] passengers can often be added on the flight manifest as [redacted] location; however, transportation of [redacted] passengers [redacted] on board must be approved [redacted] by Comd ATF-I or Comd JTF-I.

6. To provide command and control oversight for the approval of a 2nd LOT, an improved Mission Acceptance was introduced on 13 Dec 16. Between 13 and 28 Dec 16, 5/24 (20.8%) of missions, were approved by Comd ATF-I [redacted] A further 9/24 (37.5%) missions contained [redacted] meaning that 10/24 (41.7%) of missions were [redacted] Comparatively, 3/8 (37.5%) of missions from 1-12 Dec 16 and 20/22 (90.1%) of missions in Nov 16 [redacted] The trend indicates that the Tac Avn Det has [redacted] its support to [redacted] while the demand for Tac Avn resources in [redacted]

7. The Tac Avn Det currently operates with [redacted] CH146s. From 6 Oct 16 to 28 Dec 16, the Tac Avn Det serviceability rate has ranged between 82%-94%. During that period, there have been no instances when the Tac Avn Det has reported less than 2 aircraft serviceable and no mission cancellations due to maintenance issues. In fact, there were only [redacted] helicopter was reported [redacted] should the Tac Avn Det [redacted] aircraft, it is unlikely that any missions would be [redacted] Moreover, [redacted] would alleviate some of the force generation challenges within the RCAF (Ref F).

8. The Tac Avn Det has been allocated 1500 hrs of YFR for FY 16/17 (Ref B). To date, 675.9 hrs of the initially allocated YFR have been flown. Although the Tac Avn Det is trending to fly their planned YFR, they are [redacted] airlift [redacted] to fly their allocated YFR and will require [redacted] to meet the YFR objectives. The current tasking trend indicates a [redacted] Tac Avn [redacted] fly the allocated YFR with 4 aircraft.

SECRET

2/3

s.15(1)

SECRET

CONCLUSION

9. The [redacted] the closure of [redacted] coupled with the crossing [redacted] have caused a [redacted] Tac Avn [redacted]. Consequently, an [redacted] in Tac Avn resources to [redacted] has been noted and is expected to continue for the foreseeable future. With an [redacted] in support of CF, and a planned overall flying rate in excess of current YFR demand, it is assessed that [redacted] to the Tac Avn Det would have [redacted] on operations in [redacted]. Nonetheless, ATF-I may have to return some YFR as it is unknown if all the allocated hours can be flown with [redacted]. Based on a lower op tempo to [redacted] it is expected that the majority of Tac Avn resources will likely be [redacted]. Therefore, consideration should be given to [redacted] the detachment alleviate RCAF FG pressures. Due to the fact that Tac Avn resources [redacted] ATF-I is seeking direction and guidance to continue providing [redacted] of aviation resources to support [redacted].

15-1

Prepared by: LCol
 Reviewed by: LCol
 Approved by: Col

ATF-I CO OSE
 CO Tac Avn Det
 ATF-I Comd

17

Date Prepared: 30 Dec 2016

SECRET
3/3

15(1)

SECRET// [redacted]

3350 – OP IMPACT

BRIEFING NOTE FOR CJOC J3

TAC AVN DET – EMPLOYMENT RFIS

- Refs: A. E-mail Col [redacted] to Col [redacted] Op IMPACT Tac Avn Employment, 04 Jan 2017
- B. JTF-I BN - Tac Avn [redacted] 30 Dec 2016
- C. Tac Avn CONOPS Revision 1 - 14 Dec 2016

J3
15-1

AIM

- 1. To provide JTF-I responses to CJOC RFIs IAW Ref A.

BACKGROUND

- 2. The JTF-I BN at Ref B, describes how changes in the operational environment have conditioned the reduction of Tac Avn [redacted] has been [redacted] Amplifying information to the tactical situation surrounding requests for Tac Avn support is required by CJOC to articulate tactical and operational considerations for strategic direction.

RFI RESPONSES

- 3. Executive summary of each RFI follows, with amplifying information in Annex A.
 - a. Further context on the [redacted] including a description of the proposed [redacted]
 - (1) The Tac Avn Det provides 1 Line of Task (LOT), [redacted] to conduct troop and equipment transport and Command and Liaison (C&L) tasks. All tasks conducted in [redacted] have been troop transport or C&L missions and it is expected that the mission set will remain the same. [redacted] personnel is concentrated in the general [redacted] [redacted] Annex A reflects the ratio of Tac Avn [redacted] [redacted] during the months of November and December 2016. All Tac Avn missions have taken place in a [redacted] as per the 14 Dec 16 CONOPs (Ref C). It is anticipated that Tac Avn operations will [redacted] the same [redacted] IAW Ref C.
 - b. Confirmation if JTF-I Tac Avn [redacted] would change the [redacted] and [redacted] if so, please furnish revised products.

SECRET// [redacted]

SECRET

15-1

(1) Pending approval to provide increased Tac Avn [redacted] Ref C would remain in effect and would neither change the [redacted] As a result, all missions conducted to the [redacted] from [redacted] would continue to operate in a [redacted] (see Annex A). Since Oct 16, there have been no requests from [redacted] in Annex A). Therefore, JTF-I does not anticipate [redacted] up to [redacted]. Of note, the [redacted] in [redacted] has [redacted]. The [redacted] IAW page 2 of Ref C.

c. Verification if JTF-I Tac Avn [redacted] the Mission Acceptance Approval Form (MALA), and if so, please suggest a modified product.

(1) Tac Avn support to coalition forces conducted in accordance with Ref C [redacted] the Mission Acceptance Launch Authority (MALA). However, should there be a demand from [redacted] the constraint of [redacted] would have to be [redacted] and a [redacted] would have to be [redacted]. So far, JTF-I has received no indication from the [redacted] hat operations [redacted] will be required.

d. Tactical input to the following two COAs which will likely be proposed to the SJS in the CJOC BN:

(1) COA 1 - [redacted] This option will conclude that with [redacted] Tac Avn will be [redacted] while [redacted] requests [redacted] for this low-density enabler.

(a) [redacted] indicated that demand for Tac Avn resources in the [redacted] in the foreseeable future. Therefore, in this COA, the flying rate of the Tac Avn Det would be directly [redacted] for Tac Avn support. In the event of diminished demand for Tac Avn support, consideration should be given to:

- i. [redacted] the Tac Avn Det to [redacted]
- ii. [redacted] the YFR by [redacted]; and
- iii. [redacted] of the Tac Avn Det accordingly.

(2) COA 2 - [redacted] Support to [redacted]. This approach will necessitate strategic/political policy cover for [redacted]

SECRET

s.15(1)

s.19(1)

SECRET

15-1

recognizing the implicit changes (as applicable) to
(with mitigation applied) exposure to DND/CAF equities.

- (a) Given the size of the AO in northern Iraq and rotary wing assets dedicated to there will be to justify the employment of Tac Avn Det assets. This COA can be executed as per Ref C; with no changes to the TA, ATA, RA and MALA required. Consideration should be given to:

- i. the Tac Avn Det to
- ii. YFR allocation of and
- iii. Clarify CJOC intent to provide to the

CONCLUSION

4. In summary, although the trend for Tac Avn support to the mission sets of the Tac Avn Det in support of Op IMPACT remain. The in the operating area is, given that the for the Tac Avn Det will continue to be the. Regardless of the chosen COA, it is assessed that the current level of Tac Avn can be maintained by. Additional considerations should be given to depending on the chosen COA. Finally, JTF-I is seeking clarification on CJOC intent to provide

Prepared by: Maj , ATF-I A5
Reviewed by: LCol ATF-I CO OSE
Reviewed by: LCol JTF-I COS
Approved by: Col A/JTF-I Comd

17

Date Prepared: 08 Jan 2017

Annex A: Tac Avn Mission Requests – November/December 2016

SECRET

Page 3884

**is withheld pursuant to section
est retenue en vertu de l'article**

15(1)

**of the Access to Information Act
de la Loi sur l'accès à l'information**

Op IMPACT Transition Update Brief to A/Comd CJOC

20 July 2016

This presentation is classified
SECRET//Rel to CAN

15(1)

Op IMPACT LoE 4 Recce Brief – Preliminary Backbrie**OUTLINE**

- Op IMPACT LoE 4 Recce to Jordan and Lebanon completed 20 July 2016.
- Full backbrief to Comd planned for week of 25 July 2016.
- Looking for authority to go on tender for Real-Life Support (RLS) contracts for accommodations and vehicles, in order to meet CTAT deployment timelines of 15 Aug 2016.

Op IMPACT LoE 4 Recce Brief – Recce Plan and Goals

Situation: CJOC is preparing to deploy and implement a Canadian Training Assistance Team to Jordan and Lebanon.

Mandate: In order to coordinate BPC delivery and secure real life support, force protection, communication and technical requirements, a recce will be conducted to Jordan and Lebanon to meet with Allied staff and planners, Host Nation military authorities, and to conduct site surveys of potential work, accommodation and travel requirements. The recce will also set the conditions for delivery of Training or equipment for fall 2016.

Recce Mission Statement: CJOC will deploy a team to conduct a recce in order to develop the initial operating plan and RLS requirements for the Op IMPACT LoE 4 BPC effort in both Jordan and Lebanon.

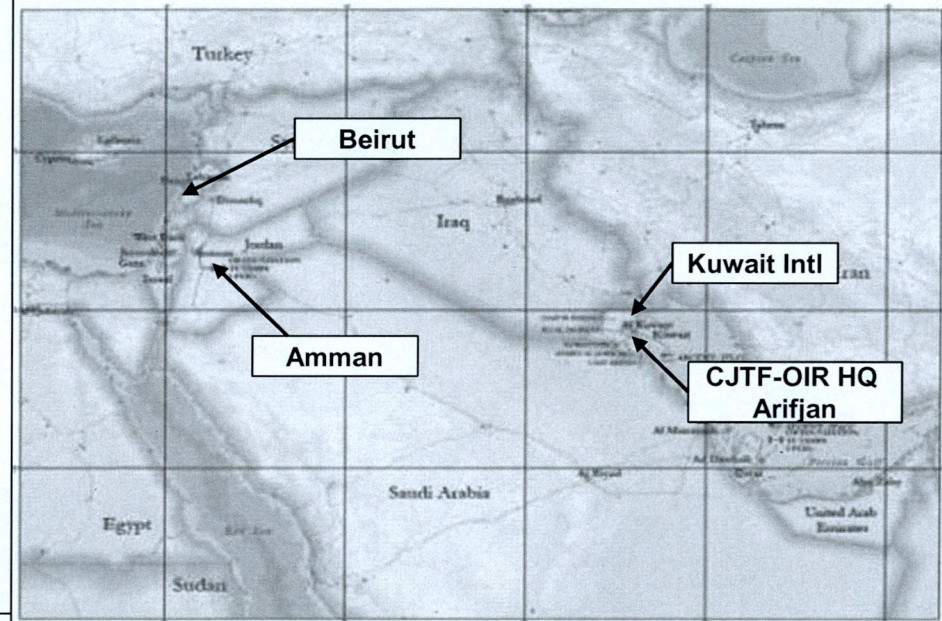

Recce Team Composition:

- CJOC Recce Lead: Maj [redacted]
- JTF-I POLAD: C. [redacted]
- CA HQ Rep: Maj [redacted]
- LCS Ops: MCpl [redacted]
- CTAT Lead Jordan: Lcol [redacted]
- CTAT Lead Lebanon: Lcol [redacted]
- J4 RLS Lead: Maj [redacted]
- J4 Contracts #1: MWO [redacted]
- J4 Contracts #2: MWO [redacted]
- J2: Lt [redacted]
- JTF-I J2 CI: K. [redacted]
- J6: Capt [redacted]

Timeline:

- 07 July 2016: Transit
- 08 July 2016: Transit/Acclimatization
- 09 July 2016: Acclimatization
- 10 July 2016: Embassy/Allied Meetings
- 11 July 2016: Day 1 of 2 for JOR
- 12 July 2016: Day 2 of 2 for JOR
- 13 July 2016: Day 1 of 3 for LEB
- 14 July 2016: Day 2 of 3 for LEB
- 15 July 2016: Day 3 of 3 for LEB
- 16 July 2016: Transit to KWT
- 17 July 2016: Flexibility
- 18 July 2016: Backbrief to Comd JTF-I
- 19 July 2016: Transit
- 20 July 2016: Backbrief to Comd CJOC

- 6 June 2016: Ramadan starts
- 17 June 2016: CDS FragO 002 to Op IMPACT Directive 002 : CAF Partner Capacity Building in Jordan and Lebanon
- 30 June 2016: OSTR for recce approved
- 4 July 2016: Recce order published
- 5 July 2016: Ramadan Ends: Eid Al-Fair
- 30 July 2016: NLT CAF deploys CTAT in both countries (slipped to 15 Aug, briefed to CDS) - IOC
- 15 Aug 2016: Planned deployment of CTAT
- 30 Sept 2016: NLT CAF deploys training delivery teams - FOC

Triple goal of Recce:

- Operational Recce: Gather needed information to publish a CJOC order related to LoE 4
- RLS Tactical Recce: Setup RLS to enable arrival of CTAT 15 Aug 16
- BPC Surge Recce: Propose initial projects to HN IOT accelerate FOC

Op IMPACT LoE 4 Recce Brief – Jordan – J4

• Real-Life Support (RLS):

- Contracted support for accn, transport and linguist
- Contracted surge capability for training teams (RLS)
- CTAT Log O – deployed contracting quals/experience
 - Accn – hotel (IOC), leased apt/house (FOC)
 - Local hotels – within city of Amman (IOC)
 - Embassy recommended hotels – meets security requirements, low visibility
 - Many compliant hotels – approved SOW to present to industry
 - Apt/houses (FOC) of Cdn Embassy (Km radius)
 - Apt/houses (furnished + unfurnished)
 - CJOC JEngr – leasing real property

- Transport – Travel requirement is for rented
Comd JTF-I would prefer Tm to have

- rented 4 x 4 SUVs – For IOC. Approved SOW to present to industry
- rented 4 x 4 SUVs - (2 x Principals + 1 Spare/Flexibility/Surge)
- Flexibility to rent larger vehs as required (SUVs, vans, buses, etc.) – CTAT Log O
- not recommended (- requirement for drivers?

154

Op IMPACT LoE 4 Recce Brief – Guidance

Looking for authority to go on tender for Real-Life Support (RLS) contracts for accommodations and vehicles, in order to meet CTAT deployment timelines of 15 Aug 2016.

	Jordan
Accom	Local hotels Amman
Vehicles	Rented SUV's (IOC)
	Rented SUV's (FOC)

	Lebanon
	Local hotels Beirut
	Rented SUV's (IOC)
	Rented SUV's (FOC)

15-1

Op IMPACT Transition
LoE 4 Build Partner Capacity
Jordan & Lebanon
Comd CJOC Update Brief

27 July 2016

This presentation is classified
SECRET//REL to CAN

15(1)

Op IMPACT LoE 4 Recce Brief – LoE 4 Overview

Proposed Intent:

In both JOR and LEB, CJOC will provide surge Build Partner Capacity to fulfill training and equipping gaps. In the short term, CJOC will deploy an enduring Country Training Assessment Team (CTAT) which will enhance mil-to-mil engagements, explore opportunity for Partner Capacity Building and staff projects for consideration. Upon reception of the projects, CJOC will conduct inter-departmental JOPG (SJS, ADM(Pol), GAC, CANSOFCOM, Force Generators) to secure funding, synchronize BPC efforts and operationalize the surge Training capabilities. CJOC will conduct as required, until the

and a stable situation.

Proposed Scheme of Manoeuvre:

- Phase 1: **Exploration of options for BPC** (Enduring task)
- Deploy a CTAT;
 - Develop mil-to-mil relationship with HN;
 - Participate in monthly country-specific BPC programming meetings;
 - Explore options for BPC;
 - Complete operational design for in-country BPC;
 - Develop longer-term projects; and
 - Staff BPC proposals.
- Phase 2: **Conduct surge BPC**
- Operationalize and resource proposed options if deemed appropriate, relevant and realistic;
 - Deploy BPC Training and Equipping; and
 - Redeploy BPC once Trg completed.
- Phase 3: **Transition to Host Nation SASE**
- Continually monitor and report on the HN situation.

CTAT Roto 0 Composition:

- CTAT Lead: Lcol (Combat arms)
- CTAT SM: CWO
- Log O: Capt to Maj
- Sig/Op: Cpl to Sgt
- Intelligence: IntO or NCM
- CTAT composition flexible
- 1 yr deployment recommended – 6 months for Roto 0
- Surge BPC capabilities deployed under OPCOM of appropriate CTAT for the limited period they are required;
- Limited support to CTAT and BPC Tm's provided remotely by JTF-I as required.

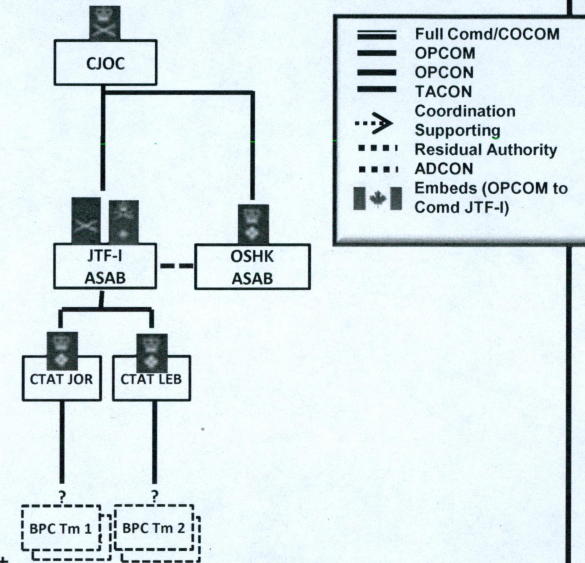

Types of Submissions

- Episodic support (e.g. trg)
- Semi-permanent support (e.g. extended mentoring)
- Equipment purchase
- Equipment donation
- Infrastructure purchase
- Third location training (e.g. in Canada)

Op IMPACT LoE 4 Recce Brief – Limitations

- CTAT no more than pers per country;
- LoE 4 complete no more than pers per country;
- \$4.4M per country per year allocated to LoE 4 as per govt mandate. Financials authorities are released through GAC's Counter-Terrorism Capacity Building Program (CTCBP);
- While not the only financing option for projects, success criteria for GAC is that CTCBP funds have been expended during the FY; and
- No lethal aid.

Op IMPACT LoE 4 Recce Brief – Recce Plan and Goals

Situation: CJOC is preparing to deploy and implement a Canadian Training Assistance Team to Jordan and Lebanon.

Mandate: In order to coordinate BPC delivery and secure real life support, force protection, communication and technical requirements, a recce will be conducted to Jordan and Lebanon to meet with Allied staff and planners, Host Nation military authorities, and to conduct site surveys of potential work, accommodation and travel requirements. The recce will also set the conditions for delivery of Training or equipment for fall 2016.

Recce Mission Statement: CJOC will deploy a team to conduct a recce in order to develop the initial operating plan and RLS requirements for the Op IMPACT LoE 4 BPC effort in both Jordan and Lebanon.

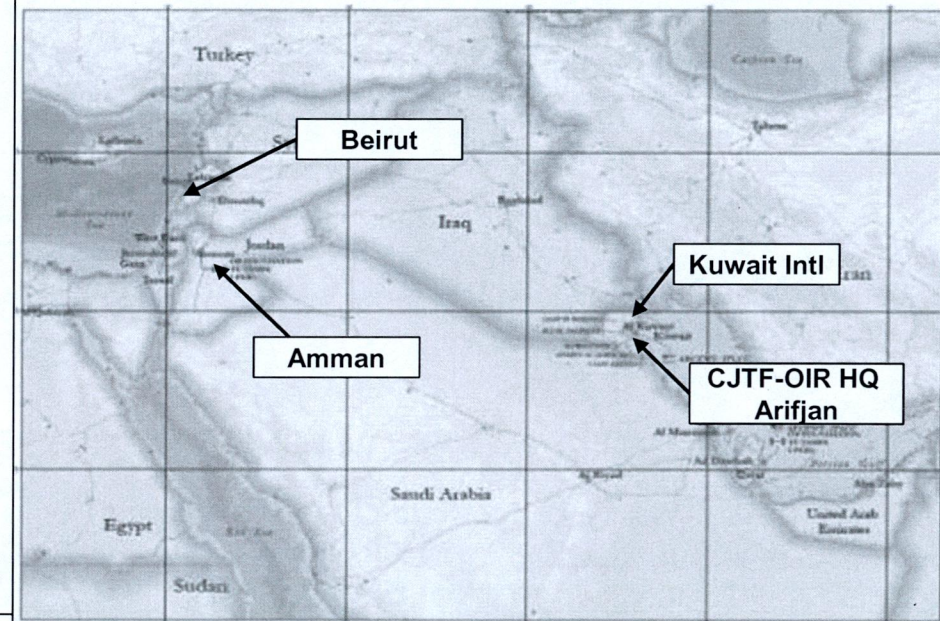

Recce Team Composition:

CJOC Recce Lead: Maj
JTF-I POLAD:
CA HQ Rep: Maj
LCS Ops: MCpl
CTAT Lead Jordan: Lcol
CTAT Lead Lebanon: Lcol
J4 RLS Lead: Maj
J4 Contracts #1: MWO
J4 Contracts #2: MWO
J2: Lt
JTF-I J2 CI: K.
J6: Capt

Timeline:

07 July 2016: Transit
 08 July 2016: Transit/Acclimatization
 09 July 2016: Acclimatization
 10 July 2016: Embassy/Allied Meetings
 11 July 2016: Day 1 of 2 for JOR
 12 July 2016: Day 2 of 2 for JOR
 13 July 2016: Day 1 of 3 for LEB
 14 July 2016: Day 2 of 3 for LEB
 15 July 2016: Day 3 of 3 for LEB
 16 July 2016: Transit to KWT
 17 July 2016: Flexibility
 18 July 2016: Backbrief to Comd JTF-I
 19 July 2016: Transit
 20 July 2016: Backbrief to Comd CJOC

6 June 2016: Ramadan starts
 17 June 2016: CDS FragO 002 to Op IMPACT Directive 002 : CAF Partner Capacity Building in Jordan and Lebanon
 30 June 2016: OSTR for recce approved
 4 July 2016: Recce order published
 5 July 2016: Ramadan Ends: Eid Al-Fair
 30 July 2016: NLT CAF deploys CTAT in both countries (slipped to 15 Aug, briefed to CDS) - IOC
 15 Aug 2016: Planned deployment of CTAT
 30 Sept 2016: NLT CAF deploys training delivery teams - FOC

Triple goal of Recce:

-Operational Recce: Gather needed information to publish a CJOC order related to LoE 4
-RLS Tactical Recce: Setup RLS to enable arrival of CTAT 15 Aug 16
-BPC Surge Recce: Propose initial projects to HN IOT accelerate FOC

Page 3894

**is withheld pursuant to section
est retenue en vertu de l'article**

15(1)

**of the Access to Information Act
de la Loi sur l'accès à l'information**

Op IMPACT LoE 4 Recce Brief – Jordan – CTAT Lead

- Focus during recce
 - establishing relationships with key pers; and
 - confirming project possibilities.
- Following Strategic Needs Assessment (SNA) conducted in Jan-Feb 16, proposals/requests for support from allied partners operating within Jordan, and the assessment that there should be a focus for a three horizon approach:
 - Horizon 1 – (initial/immediate proposal) Delivery of wet weather gear to the JAF QRF (about 1000 sets);
 - Horizon 2 – (mid-term proposal) Deployment of a battalion style logistics mentoring team to work with the JAF QRF; and
 - Horizon 3 – (Jan-Mar 17) Provision of JTAC instructors to aid the US Military Assistance Program in the establishment of a permanent JTAC training school within Jordan.
- CTAT-J Meetings 10-12 Jul
 - Canadian Embassy staff in Amman
 - US Military Assistance Program Jordan
 - JAF Director of Strategic Planning
 - Quick reaction Force
 - Royal Engineer Corps
 - Military Engagement Teams – Jordan (MET-J) at KASOTC

Op IMPACT LoE 4 Recce Brief – Jordan - POLAD

Jordan – Key Points

- **Jordanian Armed Forces well positioned to work with us**
 - TAA being reviewed
 - Goals align with Canadian Whole of Government approach
- **Existing Defence Collaboration Agreement is overarching MOU and provides Protections and Immunities to deployed Can mbrs**
- **CTAT Lead KLEs with CDA and Canadian embassy,**
- **Potential Challenges**
 - Determining which projects best fit needs of JAF and meet Canada's intent for cooperation
 - Recommended tours to be one year long
 - Mission in Jordan is relationship based
 - Takes time to build relationships and common understanding

Page 3897

**is withheld pursuant to section
est retenue en vertu de l'article**

15(1)

**of the Access to Information Act
de la Loi sur l'accès à l'information**

Op IMPACT LoE 4 Recce Brief – Jordan – J2

15-1

- **Key Takeaway:**
 - [redacted] function focus on [redacted]
 - Existing [redacted] Agreement
 - JORDAN
 - Security situation stable
 - Robust [redacted] support
 - Strong support from Canadian Embassy
- **Limitations:**
 - [redacted] only
- **Enemy situation:**
 - [redacted]
 - [redacted] within the country [redacted]
- **Refugee situation:**
 - Stable (concentrated in camps)
 - Pockets along the border
 - Relationship with Jordanian remains courteous
- **Intelligence Support:**
 - [redacted] (Medium Term)
 - [redacted] (Short Term)

Page 3899

**is withheld pursuant to section
est retenue en vertu de l'article**

15(1)

**of the Access to Information Act
de la Loi sur l'accès à l'information**

CTAT JORDAN and LEBANON – Real Life Support

Concept of Operations: CAF LoE 4 is focussed on the conduct of capacity building in JORDAN and LEBANON. CTAT of 5-15 pers will be deployed to AMMAN, JORDAN and BEIRUT, LEBANON NLT 15 Aug 16 to establish the training framework to support future surges of CAF trainers into each location.

Initial Team Composition (subject to change):
- 1 x CO, 1 x RSM, 1 x Log O, 1 x J2 NCO, 1 x Signals MCpl

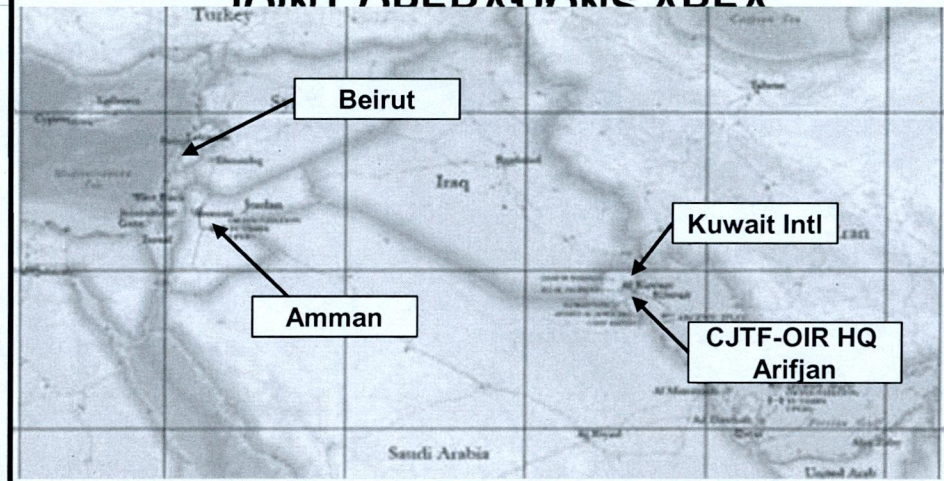

Concept of Support
Each CTAT will deploy with a very limited 1st line capacity and shall be expected to be self-sufficient through the maximum use of existing Host Nation services, new contracts and Technical Arrangements. JTF-I will provide 2nd and limited 3rd line support through its JTFSC.

CTAT members in both locations will initially live in hotel accommodations until suitable semi-permanent rental accommodations can be contracted. Surge teams accommodations will be either hotel or rental, depending on size and scope.

CTAT members in both locations will initially [redacted] in [redacted] until [redacted] can be sourced. Due to time and space considerations, JORDAN will initially require [redacted] and LEBANON will require [redacted].

Feeding. IMPs and feeding on the economy (per diem) will be used by the teams in both JORDAN and LEBANON.

Concept of Signals Support. Each CTAT will deploy with secure data and voice capability. The integral signaller will ensure intra-theatre and rear link comms.

Concept of Medical Support. Embassy recommended, Command Surg Approved, Western Accredited local medical services will be contracted for CTAT members in both JORDAN and LEBANON.

15-1

Op IMPACT LoE 4 Recce Brief – Jordan – J4

- **Real-Life Support (RLS):**
 - Contracted support for accn, transport and linguist
 - Contracted surge capability for training teams (RLS)
 - CTAT Log O – deployed contracting quals/experience
 - Accn – hotel (IOC), leased apt/house (FOC)
 - Local hotels – within city of Amman (IOC)
 - Embassy recommended hotels – meets security requirements, low visibility
 - Many compliant hotels – approved SOW to present to industry
 - Apt/houses (FOC)
 - Apt/houses (furnished + unfurnished)
 - CJOC JEngr – leasing real property
 - Transport – Travel requirement is for rented soft-skin vehs, non-armoured. Comd JTF-I would prefer Tm to have
 - rented For IOC. Approved SOW to present to industry
 - rented Principals + Spare/Flexibility/Surge)
 - Flexibility to rent larger vehs as required (SUVs, vans, buses, etc.) – CTAT Log O
 - not recommended) – requirement for drivers TBC
 - LPO – Sigs eqpt (cell phones, sim cards, printers, etc.)
 - IOC comms reqr established
 - Linguist/Translator
 - Further SOW development required
 - Define roles/responsibilities, attributes
- **Comments**
 - Material Accountability – Build and maintain DRMIS structures
 - Develop support dependency matrix for LoE 4 Op IMPACT between CTAT, Surge Tms, Embassy, JTF-I, HN, etc..
 - CTAT and BPC Surge as self-sufficient as possible

Op IMPACT LoE 4 Recce Brief – Jordan – J6

Information Exchange/Support Requirements

– **VOICE (Secure & Unsecure):**

- Smart Phones (7) with local SIMS to be procured
- CTAT Lead with Ottawa BB (1)
- IRIDIUM Phones (5): secure sleeve
- Hotel/residence landline and/or Embassy phone: secure OMNI

– **DATA (Classified & Designated):**

- DWAN via T-DVPNI Laptops (7)
 - Full print/scan
 - (next gen)
 - Print only
 - for CDA Office (Cdn Embassy)
 - (Cdn Embassy)

– **SECURE VIDEO CONFERENCE (SVTC)**

- CTAT and CDA

– **INTERNET**

- Contracted fixed line and wireless capability

– **Support Dependency Matrix**

– **Sigs NCO**

- Cpl to Sgt ACCIS CORE
- Secondary Duty: Ops NCO
- FG ROTO 0: CFJSR High Readiness pool

– **JTF-I J6**

- Crypto Support
- Installation/Support TAVs
- Sustain equipment requirements
- CIS Reports & Returns

– **Canadian Embassy**

- White bag mail service
- Short term storage
- email traffic directed to CTAT (accounts not required)
- Engagement as necessary to facilitate transport of sensitive (crypto) or high value CIS equipment into HN

– **IOC Equipment Requirements**

- FG from CJOC J6 Ops Stock & CFJSR HR Equipment
- Local procurement in theatre during Recce and at TAT (SIM Cards)

– **Theatre Activation**

- 1 x PY to enable transport and initial setup (10 days)

154

Page 3903

**is withheld pursuant to section
est retenue en vertu de l'article**

15(1)

**of the Access to Information Act
de la Loi sur l'accès à l'information**

Op IMPACT LoE 4 Recce Brief – Lebanon – CIAI Lead

CTAT Lead Overview

- Focus during recce
 - establishing relationships with key pers
 - confirming project possibilities
- Successful on both accounts
- Leadership and assistance of CDA Col [redacted] and her ACDA Sgt [redacted] were key

CTAT-L Meetings 13-15 Jul

- Canadian Embassy in Lebanon Staff
- LAF MOD J5 and J4
- Hamat Trg Centre Cmdt and S3
- UK Contractor and US Training Team Lead delivering Trg at Hamat
- Meeting with French Attaché
- NL Ambassador and Asst Attaché
- Meeting with UK Attaché and Staff

Op IMPACT LoE 4 Recce Brief – Lebanon – CIAI Lead

CTAT-L Projects

- Confirmed Proj #1: Winter Clothing. Strong need in LAF, and Canada suited to assist. Proj Proposal staffing started.
- Possible Projs
 - #2: Small Arms Trainer (SAT)
 - #3: First Aid (F/A) Trg
 - #4: Basic Recce Ptlmn Trg
 - #5: Tac-level CIMIC Tms
 - #6: “Simunition” Eqpt Hamat
 - #7: Counter-IED
 - #8: LAF Med Corps Eqpt, Org & Trg
 - #9: Engineer Eqpt
 - #10: Mtn Gear
 - #11: Lebanese ISF Professionalization

Op IMPACT LoE 4 Recce Brief – Lebanon - POLAD

Lebanon – Key Points

- **Lebanese Armed Forces keen to work with us**
 - TAA being reviewed, potential for MOU being explored
 - Concerns remain about the **CAF mbrs will deploy in Lebanon** when
 - Strategic Capabilities Plan and high-level coordination with LAF and key donor countries
 - Goals likely align with Canadian Whole of Government approach
- **CTAT Lead KLEs with CDA and Canadian embassy, NL, UK, FR**
 - Different models of cooperation, including private companies
 - Dutch CIMIC programs offers an opportunity for partnership and leadership
- **Potential Challenge**
 - Recommended tours to be one year long
 - Mission in Lebanon is relationship based
 - Takes time to build relationships and common understanding

Op IMPACT LoE 4 Recce Brief – Lebanon – Force Protection

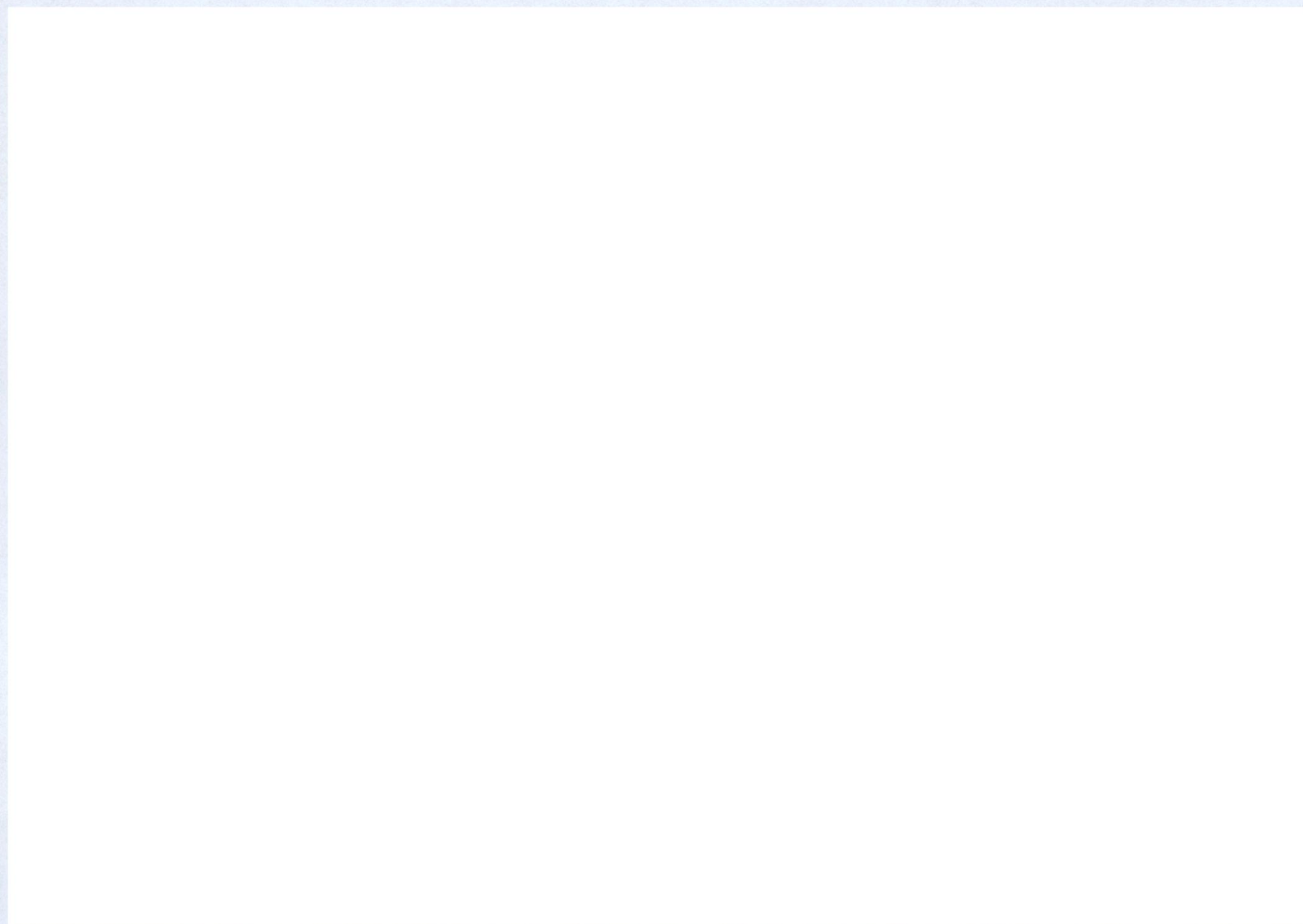

- Following [redacted] (April 16), from Embassy [redacted]
- Zone: [redacted]
- Zones: [redacted], AV, Sat Phone or PRSN [redacted] zones: [redacted]
- [redacted] AV, Sat Phone or PRSN [redacted] zones: [redacted]
- [redacted] AV, Sat Phone or PRSN [redacted]
- [redacted] measures TBC
- [redacted] Zones [redacted] security measures [redacted]
- Almost all locations where CTAT and Surge Tms are expected to go [redacted]
- **Recommendations:**
- Follow [redacted] as much as possible;
- Multiple redundant Comms,
- Access to multiple AV [redacted]
- [redacted]
- Logical reporting mechanism to JTF-I.
- [redacted] except at training location.

15,

Op IMPACT LoE 4 Recce Brief – Lebanon – J2

15.1

• **Key Takeaway:**

- [redacted] function focus on [redacted]
- [redacted] Agreement
- Existing concerns about [redacted] as a legitimate source of security
- LEBANON
 - Security [redacted]
 - [redacted] support
 - [redacted] from Canadian Embassy

• **Limitations:**

- [redacted] support / Limited [redacted]

• **situation:**

- [redacted] conducting [redacted] along the [redacted]
- [redacted] within the country (Beirut, Tripoli, [redacted])
- Beirut specific [redacted] Rafik Hariri Airport [redacted]

• **situation:**

- [redacted] Scattered across the country)
- Relationship with [redacted]

• **Overall Situation:**

- Security Forces (LAF, GS, ISF – [redacted])
- [redacted] Christians, Shias, Sunnis, Druze, etc...

• **support:**

- [redacted] (Medium Term)
- [redacted] (Short Term)

15.1

15 (1)

Page 3909

**is withheld pursuant to section
est retenue en vertu de l'article**

15(1)

**of the Access to Information Act
de la Loi sur l'accès à l'information**

Commandement des opérations interarmées du Canada

SECRET//**CTAT JORDAN and LEBANON – Real Life support**

Concept of Operations: CAF LoE 4 is focussed on the conduct of capacity building in JORDAN and LEBANON. CTAT of 5-15 pers will be deployed to AMMAN, JORDAN and BEIRUT, LEBANON **NLT 15 Aug 16** to establish the training framework to support future surges of CAF trainers into each location.

Initial Team Composition (subject to change):

- 1 x CO, 1 x RSM, 1 x Log O, 1 x J2 NCO, 1 x Signals MCpl

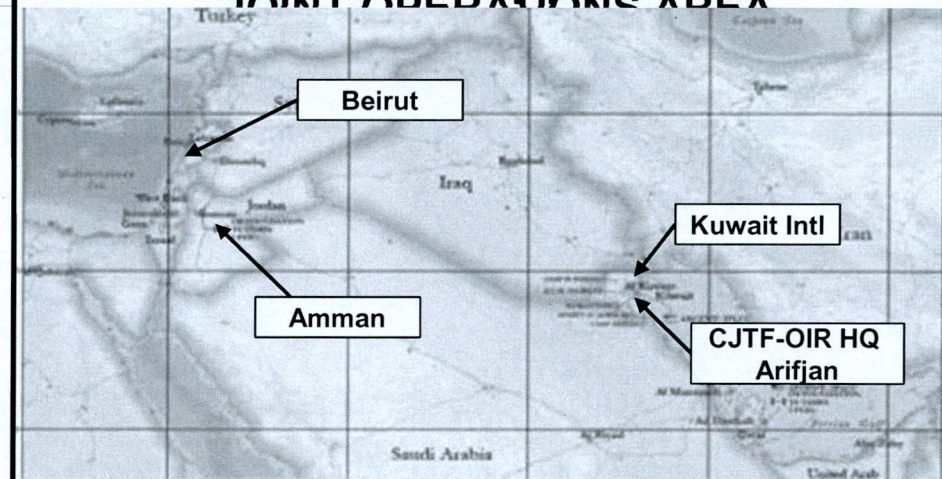
**Concept of Support**

Each CTAT will deploy with a very limited 1st line capacity and shall be expected to be self-sufficient through the maximum use of existing Host Nation services, new contracts and Technical Arrangements. JTF-I will provide 2nd and limited 3rd line support through its JTFSC.

CTAT members in both locations will initially live in hotel accommodations until suitable semi-permanent rental accommodations can be contracted. Surge teams accommodations will be either hotel or rental, depending on size and scope.

CTAT members in both locations will [redacted] /s can be sourced. Due to time and space considerations, JORDAN will initially require [redacted] and LEBANON will require [redacted].

Feeding. IMPs and feeding on the economy (per diem) will be used by the teams in both JORDAN and LEBANON.

Concept of Signals Support. Each CTAT will deploy with secure data and voice capability. The integral signaller will ensure intra-theatre and rear link comms.

Concept of Medical Support. Embassy recommended, Command Surg Approved, Western Accredited local medical services will be contracted for CTAT members in both JORDAN and LEBANON.

21 July 16 **SECRET//**

Canadian Joint Operations Command

A0639431_21-003910

Op IMPACT LoE 4 Recce Brief – Lebanon – J4

- **Real-Life Support (RLS):**
 - Contracted support for accn, transport and linguist
 - Contracted surge capability for training teams (RLS)
 - CTAT Log O – deployed contracting quals/experience
 - Accn – hotel (IOC), leased apt/house (FOC)
 - Local hotels – within city of Beirut (IOC)
 - Embassy recommended hotels – meets security requirements, low visibility
 - Many compliant hotels – approved SOW to present to industry
 - Experiences gathered from Op PROVISION (SOW development)
 - Apt/houses (FOC) – located in northern Beirut
 - Apt/houses (furnished + unfurnished)
 - CJOC JEngr – leasing real property
 - Transport [redacted] vehs (IOC) + [redacted] (FOC)
 - [redacted] (IOC) – approved SOW to present to industry
 - [redacted] – travel to [redacted]
 - Flexibility to rent larger vehs as required (SUVs, vans, buses, etc.) – CTAT Log O
 - [redacted] not recommended [redacted] requirement for drivers TBC
 - LPO – local IT eqpt (cell phones, sim cards, printers, etc.)
 - IOC comms reqr established
 - Linguist/Translator
 - Further SOW development required
 - Define roles/responsibilities, attributes
- **Comments**
 - Material Accountability – Create and maintain DRMIS structures
 - Develop support dependency matrix – LoE 4 Op IMPACT between CTAT, Surge Tms, JTF-I, Embassy, HN, etc
 - CTAT and BPC Surge as self-sufficient as possible

Op IMPACT LoE 4 Recce Brief – Lebanon – J6**Information Exchange/Support Requirements**

- **VOICE (Secure & Unsecure):**
 - Smart Phones (7) with local SIMS to be procured
 - CTAT Lead with Ottawa BB (1)
 - IRIDIUM Phones (2): secure sleeve
 - Hotel/residence landline and/or Embassy phone: secure OMNI
- **DATA (Classified & Designated):**
 - DWAN via T-DVPNI Laptops (7)
 - Full print/scan
 - [REDACTED]
 - Print only
 - [REDACTED] Office Amman only)
 - Full print/scan
 - [REDACTED] (Cdn Embassy)
- **SECURE VIDEO CONFERENCE (SVTC)**
 - CTAT & CDA Office
- [REDACTED]
- **INTERNET**
 - Contracted fixed line and wireless capability
- **Sigs NCO**
 - Cpl to Sgt ACCIS CORE
 - Secondary Duty: Ops NCO
 - FG ROTO 0: CFJSR High Readiness pool
- **JTF-I J6**
 - Crypto Support
 - Installation/Support TAVs
 - Sustain equipment requirements
 - CIS Reports & Returns
- **Canadian Embassy**
 - White bag mail service
 - Short term storage
 - [REDACTED] email traffic directed to CTAT (accounts not required)
 - Engagement as necessary to facilitate transport of sensitive (crypto) or high value CIS equipment into HN
- **IOC Equipment Requirements**
 - FG from CJOC J6 Ops Stock & CFJSR HR Equipment
 - Local procurement in theatre during Recce and at TAT
- **Theatre Activation**
 - 1 x PY to enable transport and initial setup (10 days)
 - 4/5 PYs to install [REDACTED] Solution CDA Jordan (5 days)
 - FG: Hybrid JTF-I J6 & CJOC/CFJSR

15-1

15 (1)

Op IMPACT LoE 4 Recce Brief – Project Approval Process Template

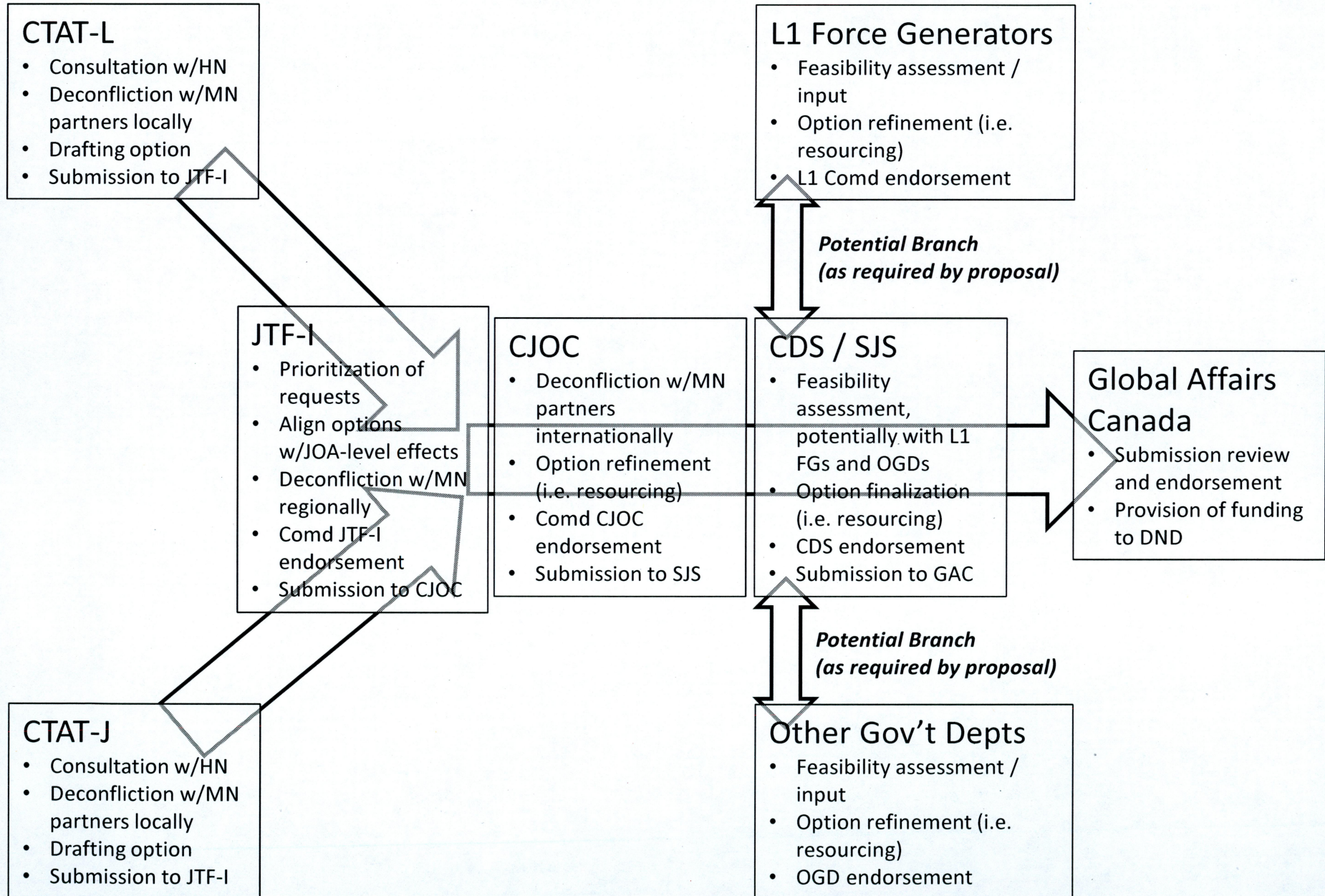

15 (1)

Op IMPACT LoE 4 Recce Brief – Summary

CTAT OLR Recce – Outstanding Items

- Force Protection
 - Recommend (enhanced)
- Programming
 - Development of a project approval process
 - Timeliness: impact on confidence of LAF/JAF and credibility of CAF/GoC
 - CJOC ability to deliver GAC CTCBP
- Canadian specific relevant contributions synchronized with Allied efforts

Op IMPACT

Commander's Update

27 Jul 16

- Inflow
- Erbil Camp
- MLT Close Protection & ASUVs
- CTAT Recce
- R2 Field Hospital

Op IMPACT Personnel and Capability In-Flow

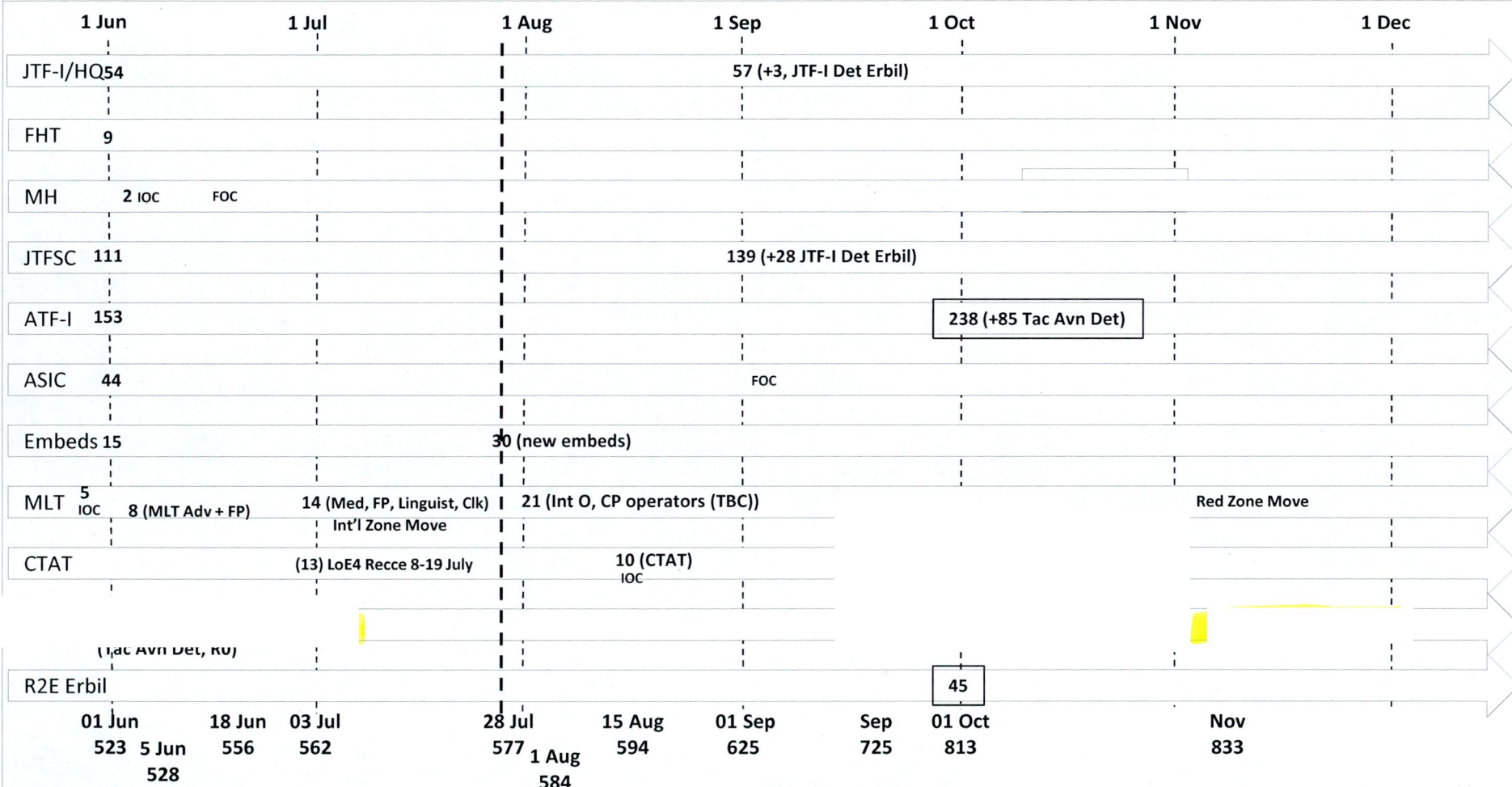

RECENT MILESTONES

- Capability
 - Embed Staff (last embed arrives on 28 July)
 - Theatre opening team (on-going)
- Authorities (staffed for approval)
 - TO&E change #9 (Tac Avn Det, JTF-I Det Erbil, ATF-I HQ) with SJS
 - C2 FHT, MP – CJOC Frag 0
- Planning / movements
 - CTAT Recce (8-19 July)

UPCOMING ACTIVITIES

- Capability
 - MLT Vehicle
 - MLT CP plus up
 - Tac Avn Det
- Planning
 - JTF-I Det Erbil
 - R2E Erbil Planning
 - CTAT IOC Planning

15-1

15(1)

Op IMPACT – Erbil Camp Build

Erbil Theatre Opening (TO) Timeline

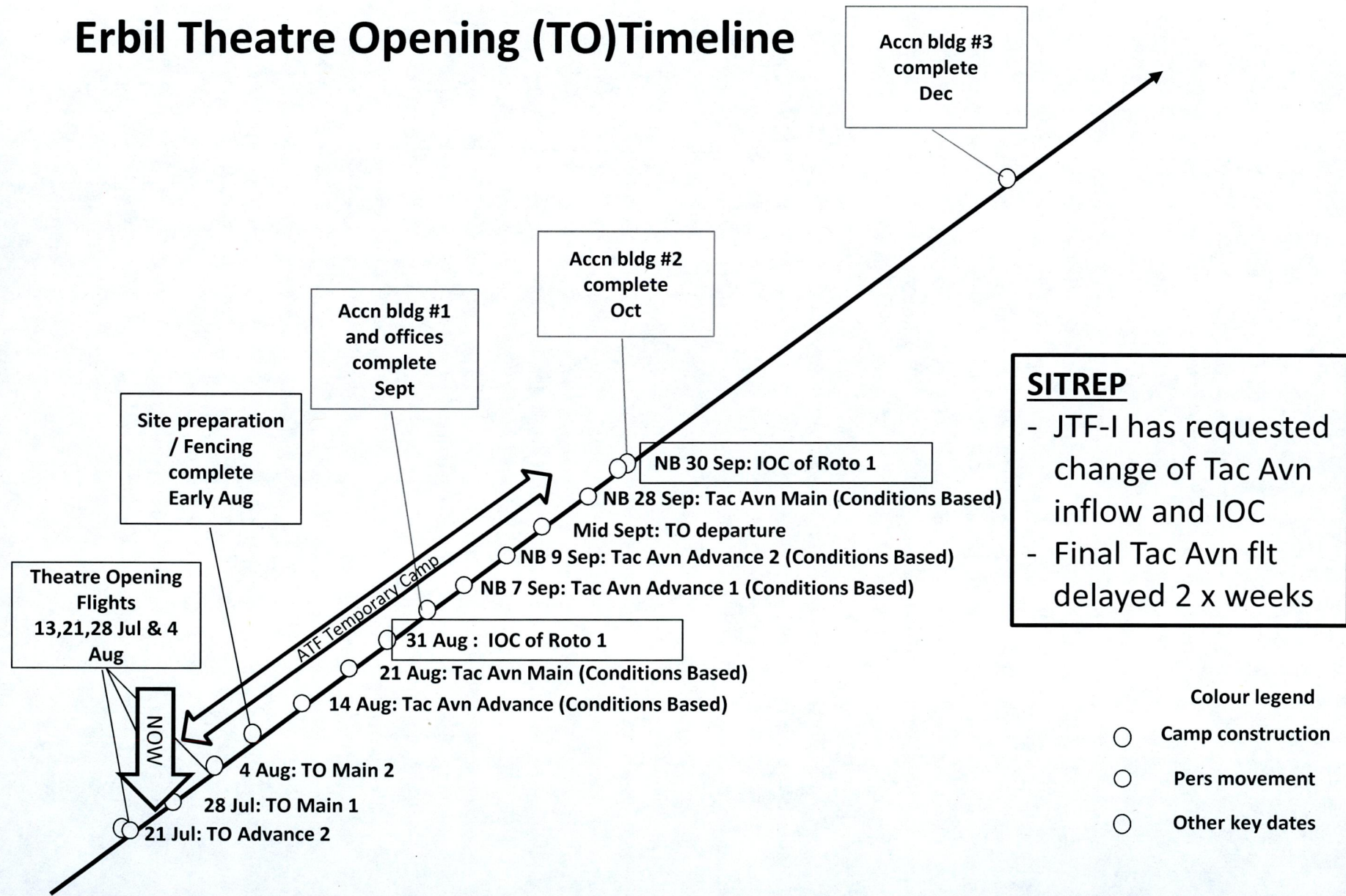

Op IMPACT – MLT Close Protection and Force Protection

Current Situation:

- MLT IOC allows [redacted] in either the [redacted]
- [redacted] are deployed to provide [redacted] using [redacted]

MLT Mobility Concept of Employment:

Refs: MLT BN received 19 Jul 16/Email MLT J2 to JTF-I J35 19 Jul 16

- [redacted] will form the basis of the [redacted] elm for the MLT Dir and the 12 x O-6 LOs.
- O-6s will require [redacted] moves and [redacted] per [redacted] in addition to the MLT Dir's
 - Necessitates concurrent [redacted]
- An [redacted] moves requires [redacted] and an [redacted] requires [redacted]
- The [redacted] required number to support this concept is [redacted]

JTF-I Request: (Ref: JTF-I letter received 19 Jul 16)

- [redacted] additional [redacted] be deployed in support of MLT to facilitate [redacted]
 - CJTF-OIR concurs
 - RLS is available at UNION III

Available Resources:

1. [redacted] trained for this msn in 14 days NTM
2. [redacted] Cbt Arms NCMs
 - [redacted] can deploy NB 1 Sep 16

Related Issues:

- **HLTA Backfill:** The [redacted] avail [redacted] are also HLTA backfill replacements for the CPO currently deployed (first backfill depl 2 Aug)
- **CA FP Pers:** CA seeks confirmation whether these pers are required
- **Delivery of CDN [redacted]** ETA Nov 16

Recommendation:

- Deploy remaining trained ava [redacted] NLT 15 Aug 16

**SECRET//
Update**

Op IMPACT – MLT

Provisional Timeline

NOTE:

Acquisition = ADM(Mat)/PSPC Lead - FMS, timeline TBC

Integration = CA/US DoS lead,

Testing = CA/ADM(S&T) Lead,

Installation = CA/DoS Lead, in theatre

SITREP

- "First in Class" vehicle will arrive in US on 2 Aug
- ADM (Mat) approved procurement

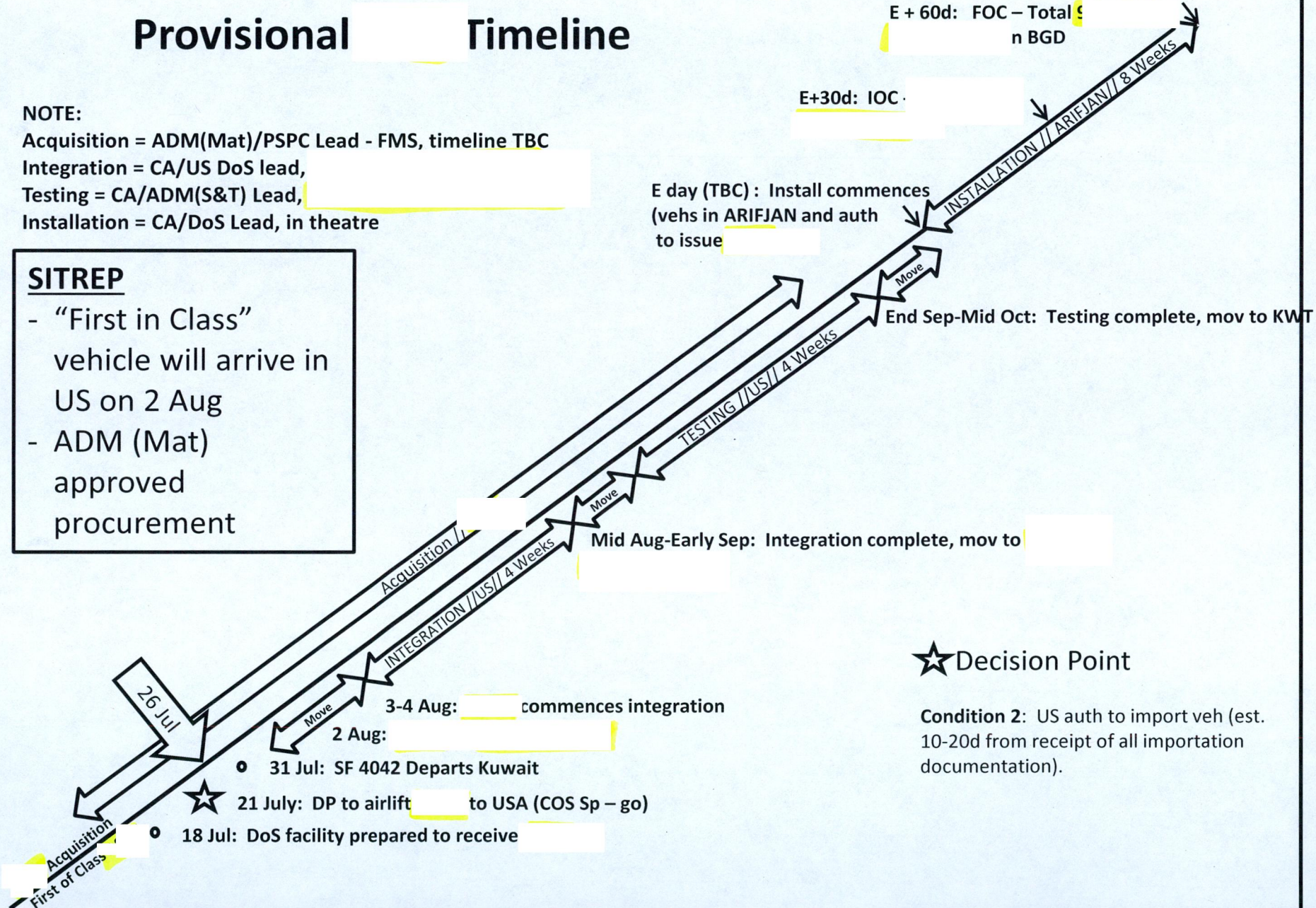

★ Decision Point

Condition 2: US auth to import veh (est. 10-20d from receipt of all importation documentation).

15 (1)

Op IMPACT LoE 4 Recce Brief – LoE 4 Overview

Proposed Intent:

In both JOR and LEB, CJOC will provide surge Build Partner Capacity to fulfill training and equipping gaps. In the short term, CJOC will deploy an enduring Country Training Assessment Team (CTAT) which will enhance mil-to-mil engagements, explore opportunity for Partner Capacity Building and staff projects for consideration. Upon reception of the projects, CJOC will conduct inter-departmental JOPG (SJS, ADM(Pol), GAC, CANSOFCOM, Force Generators) to secure funding, synchronize BPC efforts and operationalize the surge Training capabilities. CJOC will conduct surge BPC as required, until the

Proposed Scheme of Manoeuvre:

- Phase 1: **Exploration of options for BPC** (Enduring task)
 - Deploy a CTAT;
 - Develop mil-to-mil relationship with HN;
 - Participate in monthly country-specific BPC programming meetings;
 - Explore options for BPC;
 - Complete operational design for in-country BPC;
 - Develop longer-term projects; and
 - Staff BPC proposals.
- Phase 2: **Conduct surge BPC**
 - Operationalize and resource proposed options if deemed appropriate, relevant and realistic;
 - Deploy BPC Training and Equipping; and
 - Redeploy BPC once Trg completed.
- Phase 3: **Transition to Host Nation SASE**
 - Continually monitor and report on the HN situation.

CTAT Roto 0 Composition:

- CTAT Lead: 1 x Lcol (Combat arms)
- CTAT SM: 1 x CWO
- Log O: 1 x Capt to Maj
- Sig/Op: 1 x Cpl to Sgt
- Intelligence: 1 x IntO or NCM
- CTAT composition flexible
- 1 yr deployment recommended – 6 months for Roto 0
- Surge BPC capabilities deployed under OPCOM of appropriate CTAT for the limited period they are required;
- Limited support to CTAT and BPC Tm's provided remotely by JTF-I as required.

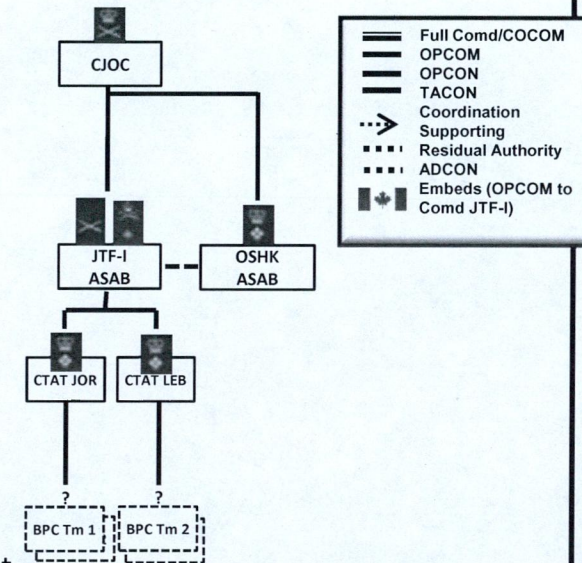

Types of Submissions

- Episodic support (e.g. trg)
- Semi-permanent support (e.g. extended mentoring)
- Equipment purchase
- Equipment donation
- Infrastructure purchase
- Third location training (e.g. in Canada)

15(1)

Op IMPACT LoE 4 Recce Brief – Limitations

- CTAT no more than pers per country;
- LoE 4 complete no more than pers per country;
- \$4.4M per country per year allocated to LoE 4 as per govt mandate. Financials authorities are released through GAC's Counter-Terrorism Capacity Building Program (CTCBP);
- While not the only financing option for projects, success criteria for GAC is that CTCBP funds have been expended during the FY; and
- No lethal aid.

15.1

Op IMPACT LoE 4 Recce Brief – Recce Plan and Goals

Situation: CJOC is preparing to deploy and implement a Canadian Training Assistance Team to Jordan and Lebanon.

Mandate: In order to coordinate BPC delivery and secure real life support, force protection, communication and technical requirements, a recce will be conducted to Jordan and Lebanon to meet with Allied staff and planners, Host Nation military authorities, and to conduct site surveys of potential work, accommodation and travel requirements. The recce will also set the conditions for delivery of Training or equipment for fall 2016.

Recce Mission Statement: CJOC will deploy a team to conduct a recce in order to develop the initial operating plan and RLS requirements for the Op IMPACT LoE 4 BPC effort in both Jordan and Lebanon.

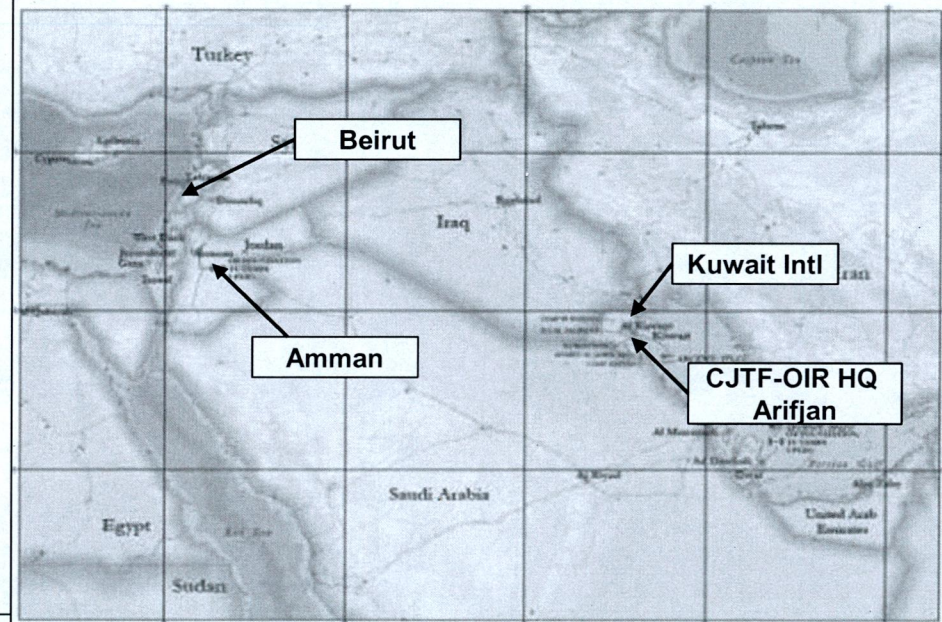

Recce Team Composition:

- CJOC Recce Lead: Maj
- JTF-I POLAD: C.
- CA HQ Rep: Maj
- LCS Ops: MCpl
- CTAT Lead Jordan: Lcol
- CTAT Lead Lebanon: Lcol
- J4 RLS Lead: Maj
- J4 Contracts #1: MWC
- J4 Contracts #2: MWC
- J2: Lt
- JTF-I J2 CI: K.
- J6: Capt

Timeline:

- 07 July 2016: Transit
- 08 July 2016: Transit/Acclimatization
- 09 July 2016: Acclimatization
- 10 July 2016: Embassy/Allied Meetings
- 11 July 2016: Day 1 of 2 for JOR
- 12 July 2016: Day 2 of 2 for JOR
- 13 July 2016: Day 1 of 3 for LEB
- 14 July 2016: Day 2 of 3 for LEB
- 15 July 2016: Day 3 of 3 for LEB
- 16 July 2016: Transit to KWT
- 17 July 2016: Flexibility
- 18 July 2016: Backbrief to Comd JTF-I
- 19 July 2016: Transit
- 20 July 2016: Backbrief to Comd CJOC

- 6 June 2016: Ramadan starts
- 17 June 2016: CDS FragO 002 to Op IMPACT Directive 002 : CAF Partner Capacity Building in Jordan and Lebanon
- 30 June 2016: OSTR for recce approved
- 4 July 2016: Recce order published
- 5 July 2016: Ramadan Ends: Eid Al-Fair
- 30 July 2016: NLT CAF deploys CTAT in both countries (slipped to 15 Aug, briefed to CDS) - IOC
- 15 Aug 2016: Planned deployment of CTAT
- 30 Sept 2016: NLT CAF deploys training delivery teams - FOC

Triple goal of Recce:

- Operational Recce: Gather needed information to publish a CJOC order related to LoE 4
- RLS Tactical Recce: Setup RLS to enable arrival of CTAT 15 Aug 16
- BPC Surge Recce: Propose initial projects to HN IOT accelerate FOC

15 (17)

Page 3923

**is withheld pursuant to section
est retenue en vertu de l'article**

15(1)

**of the Access to Information Act
de la Loi sur l'accès à l'information**

Op IMPACT LoE 4 Recce Brief – Jordan – CIAI Lead

- Focus during recce
 - establishing relationships with key pers; and
 - confirming project possibilities.
- Following Strategic Needs Assessment (SNA) conducted in Jan-Feb 16, proposals/requests for support from allied partners operating within Jordan, and the assessment that there should be a focus for a three horizon approach:
 - Horizon 1 – (initial/immediate proposal) Delivery of wet weather gear to the JAF QRF (about 1000 sets);
 - Horizon 2 – (mid-term proposal) Deployment of a battalion style logistics mentoring team to work with the JAF QRF; and
 - Horizon 3 – (Jan-Mar 17) Provision of JTAC instructors to aid the US Military Assistance Program in the establishment of a permanent JTAC training school within Jordan.
- CTAT-J Meetings 10-12 Jul
 - Canadian Embassy staff in Amman
 - US Military Assistance Program Jordan
 - JAF Director of Strategic Planning
 - Quick reaction Force
 - Royal Engineer Corps
 - Military Engagement Teams – Jordan (MET-J) at KASOTC

15 (1)

Op IMPACT LoE 4 Recce Brief – Jordan - POLAD

Jordan – Key Points

- **Jordanian Armed Forces well positioned to work with us**
 - TAA being reviewed
 - Goals align with Canadian Whole of Government approach
- **Existing Defence Collaboration Agreement is overarching MOU and provides Protections and Immunities to deployed Can mbrs**
- **CTAT Lead KLEs with CDA and Canadian embassy, US, JAF, UK**
- **Potential Challenges**
 - Determining which projects best fit needs of JAF and meet Canada's intent for cooperation
 - Recommended tours to be one year long
 - Mission in Jordan is relationship based
 - Takes time to build relationships and common understanding

Op IMPACT LoE 4 Recce Brief – Jordan – Force Protection

- Following [redacted] for Official Travel in Jordan (June 16), [redacted]
- [redacted], AV, Sat Phone or PRSN;
- [redacted] Zones: [redacted] AV, Sat Phone or PRSN;
- [redacted] Zones: [redacted] measures [redacted]
- [redacted] Zones: [redacted] measures; and
- Extraction and exit protocols defined.
- Most locations where CTAT and Surge Tms will need to travel to [redacted] vehicles.
- **Recommendations:**
- Follow Embassy Protocol;
- Multiple redundant Comms;
- [redacted]
- Logical reporting mechanism to JTF-I; and
- [redacted], except at training location.
- [redacted] direct [redacted] Comd JTF-I proposed employment of [redacted] will enhance protection from [redacted]

15.

15 (1)

Op IMPACT LoE 4 Recce Brief – Jordan – J2

• **Key Takeaway:**

- [redacted] function focus on [redacted]
- Existing [redacted] Agreement
- JORDAN
 - Security situation stable
 - Robust [redacted] support
 - Strong support from Canadian Embassy

• **Limitations:**

- [redacted] only

• **Enemy situation:**

- [redacted]
- [redacted] within the country [redacted]

• **Refugee situation:**

- Stable (concentrated in camps)
- Pockets along the border
- Relationship with Jordanian remains courteous

• **Intelligence Support:**

- [redacted] (Medium Term)
- [redacted] (Short Term)

15/



15 (1)

Page 3928

**is withheld pursuant to section
est retenue en vertu de l'article**

15(1)

**of the Access to Information Act
de la Loi sur l'accès à l'information**

CTAT JORDAN and LEBANON – Real Life Support

Concept of Operations: CAF LoE 4 is focussed on the conduct of capacity building in JORDAN and LEBANON. CTAT of 5-15 pers will be deployed to AMMAN, JORDAN and BEIRUT, LEBANON **NLT 15 Aug 16** to establish the training framework to support future surges of CAF trainers into each location.

Initial Team Composition (subject to change):
- 1 x CO, 1 x RSM, 1 x Log O, 1 x J2 NCO, 1 x Signals MCpl

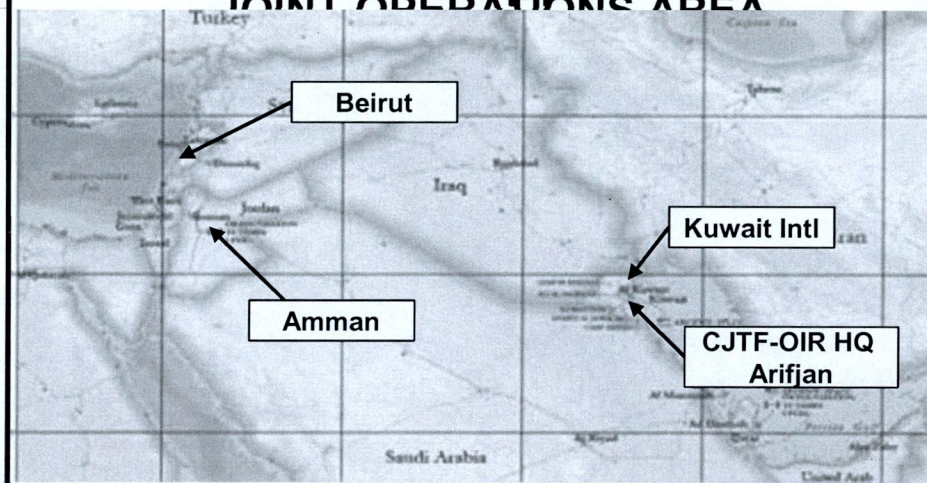

Concept of Support

Each CTAT will deploy with a very limited 1st line capacity and shall be expected to be self-sufficient through the maximum use of existing Host Nation services, new contracts and Technical Arrangements. JTF-I will provide 2nd and limited 3rd line support through its JTFSC.

CTAT members in both locations will initially live in hotel accommodations until suitable semi-permanent rental accommodations can be contracted. Surge teams accommodations will be either hotel or rental, depending on size and scope.

CTAT members in both locations will initially [redacted] until [redacted] can be sourced. Due to time and space considerations, JORDAN will initially require [redacted] and LEBANON will require [redacted]

Feeding. IMPs and feeding on the economy (per diem) will be used by the teams in both JORDAN and LEBANON.

Concept of Signals Support. Each CTAT will deploy with secure data and voice capability. The integral signaller will ensure intra-theatre and rear link comms.

Concept of Medical Support. Embassy recommended, Command Surg Approved, Western Accredited local medical services will be contracted for CTAT members in both JORDAN and LEBANON.

15(1)

Op IMPACT LoE 4 Recce Brief – Jordan – J4

• **Real-Life Support (RLS):**

- Contracted support for accn, transport and linguist
- Contracted surge capability for training teams (RLS)
- CTAT Log O – deployed contracting quals/experience
 - Accn – hotel (IOC), leased apt/house (FOC)
 - Local hotels – within city of Amman (IOC)
 - Embassy recommended hotels – meets security requirements, low visibility
 - Many compliant hotels – approved SOW to present to industry
 - Apt/houses (FOC)
 - Apt/houses (furnished + unfurnished)
 - CJOC JEngr – leasing real property
 - Transport – Travel requirement is for rented have
 - For IOC. Approved SOW to present to industry
 - x Principals + Spare/Flexibility/Surge)
 - Flexibility to rent larger vehs as required (SUVs, vans, buses, etc.) – CTAT Log O
 - not recommendec re) – requirement for drivers TBC
 - LPO – Sigs eqpt (cell phones, sim cards, printers, etc.)
 - IOC comms reqr established
 - Linguist/Translator
 - Further SOW development required
 - Define roles/responsibilities, attributes

Comd JTF-I would prefer Tm to

15/1

• **Comments**

- Material Accountability – Build and maintain DRMIS structures
- Develop support dependency matrix for LoE 4 Op IMPACT between CTAT, Surge Tms, Embassy, JTF-I, HN, etc..
- CTAT and BPC Surge as self-sufficient as possible

15(1)

Op IMPACT LoE 4 Recce Brief – Jordan – J6**Information Exchange/Support Requirements**

- **VOICE (Secure & Unsecure):**
 - Smart Phones (7) with local SIMS to be procured
 - CTAT Lead with Ottawa BB (1)
 - IRIDIUM Phones (5): secure sleeve
 - Hotel/residence landline and/or Embassy phone: secure OMNI
- **DATA (Classified & Designated):**
 - DWAN via T-DVPNI Laptops (7)
 - Full print/scan
 - _____ next gen
 - Print only
 - _____ CDA Office (Cdn Embassy)
 - _____ (Cdn Embassy)
- **SECURE VIDEO CONFERENCE (SVTC)**
 - CTAT and CDA
-
- **INTERNET**
 - Contracted fixed line and wireless capability
- **Support Dependency Matrix**
- **Sigs NCO**
 - Cpl to Sgt ACCIS CORE
 - Secondary Duty: Ops NCO
 - FG ROTO 0: CFJSR High Readiness pool
- **JTF-I J6**
 - Crypto Support
 - Installation/Support TAVs
 - Sustain equipment requirements
 - CIS Reports & Returns
- **Canadian Embassy**
 - White bag mail service
 - Short term storage
 - _____ email traffic directed to CTAT (accounts not required)
 - Engagement as necessary to facilitate transport of sensitive (crypto) or high value CIS equipment into HN
- **IOC Equipment Requirements**
 - FG from CJOC J6 Ops Stock & CFJSR HR Equipment
 - Local procurement in theatre during Recce and at TAT (SIM Cards)
- **Theatre Activation**
 - 1 x PY to enable transport and initial setup (10 days)

15 (1)

Page 3932

**is withheld pursuant to section
est retenue en vertu de l'article**

15(1)

**of the Access to Information Act
de la Loi sur l'accès à l'information**

Op IMPACT LoE 4 Recce Brief – Lebanon – CTAT Lead

CTAT Lead Overview

- Focus during recce
 - establishing relationships with key pers
 - confirming project possibilities
- Successful on both accounts
- Leadership and assistance of CDA Col [redacted] and her ACDA Sgt [redacted] were key

CTAT-L Meetings 13-15 Jul

- Canadian Embassy in Lebanon Staff
- LAF MOD J5 and J4
- Hamat Trg Centre Cmdt and S3
- UK Contractor and US Training Team Lead delivering Trg at Hamat
- Meeting with French Attaché
- NL Ambassador and Asst Attaché
- Meeting with UK Attaché and Staff

Op IMPACT LoE 4 Recce Brief – Lebanon – CTAT Lead

CTAT-L Projects

- Confirmed Proj #1: Winter Clothing. Strong need in LAF, and Canada suited to assist. Proj Proposal staffing started.
- Possible Projs
 - #2: Small Arms Trainer (SAT)
 - #3: First Aid (F/A) Trg
 - #4: Basic Recce Ptlmn Trg
 - #5: Tac-level CIMIC Tms
 - #6: “Simunition” Eqpt Hamat
 - #7: Counter-IED
 - #8: LAF Med Corps Eqpt, Org & Trg
 - #9: Engineer Eqpt
 - #10: Mtn Gear
 - #11: Lebanese ISF Professionalization

Op IMPACT LoE 4 Recce Brief – Lebanon - POLAD

Lebanon – Key Points

- **Lebanese Armed Forces keen to work with us**
 - TAA being reviewed, potential for MOU being explored
 - Concerns remain about the **CAF mbrs will deploy in Lebanon** when
 - Strategic Capabilities Plan and high-level coordination with LAF and key donor countries
 - Goals likely align with Canadian Whole of Government approach
- **CTAT Lead KLEs with CDA and Canadian embassy, NL, UK, FR**
 - Different models of cooperation, including private companies
 - Dutch CIMIC programs offers an opportunity for partnership and leadership
- **Potential Challenge**
 - Recommended tours to be one year long
 - Mission in Lebanon is relationship based
 - Takes time to build relationships and common understanding

15(1)

Op IMPACT LoE 4 Recce Brief – Lebanon – Force Protection



- Following [redacted] April 16), from [redacted]
- Zone: [redacted]
- Zones: [redacted] AV, Sat Phone or PRSN
- Zones: [redacted] zones: [redacted] AV, Sat Phone or PRSN
- Zones: [redacted] AV, Sat Phone or PRSN
- Zones: [redacted]
- Zones: [redacted]
- Almost all locations where CTAT and Surge Tms are [redacted]
- **Recommendations:**
- Follow [redacted] as much as possible;
- [redacted] Comms,
- Access to multiple AV
- [redacted]
- Logical reporting mechanism to JTF-I.
- [redacted] except at training location.

5

(50)

Op IMPACT LoE 4 Recce Brief – Lebanon – J2

• **Key Takeaway:**

- [redacted] function focus on [redacted]
- [redacted]
- Existing concerns about [redacted] as a legitimate source of [redacted]
- LEBANON
 - [redacted]
 - [redacted] support
 - [redacted] Canadian Embassy

• **Limitations:**

- [redacted]

• **situation:**

- [redacted]
- [redacted] within the country [redacted]
- Beirut specific [redacted] security

• **Refugee situation:**

- [redacted] (Scattered across the country)
- [redacted] with Lebanese [redacted]

• **Overall Situation:**

- Security Forces (LAF, GS, ISF – [redacted])
- [redacted] (Christians, Shias, Sunnis, Druze, etc... [redacted])

• **Intelligence Support:**

- [redacted] (Medium Term)
- [redacted] (Short Term)

15-1

15(1)

Page 3938

**is withheld pursuant to section
est retenue en vertu de l'article**

15(1)

**of the Access to Information Act
de la Loi sur l'accès à l'information**

Commandement des opérations interarmées du Canada

SECRET//

CTAT JORDAN and LEBANON – Real Life Support

Concept of Operations: CAF LoE 4 is focussed on the conduct of capacity building in JORDAN and LEBANON. CTAT of 5-15 pers will be deployed to AMMAN, JORDAN and BEIRUT, LEBANON NLT 15 Aug 16 to establish the training framework to support future surges of CAF trainers into each location.

Initial Team Composition (subject to change):

- 1 x CO, 1 x RSM, 1 x Log O, 1 x J2 NCO, 1 x Signals MCpl

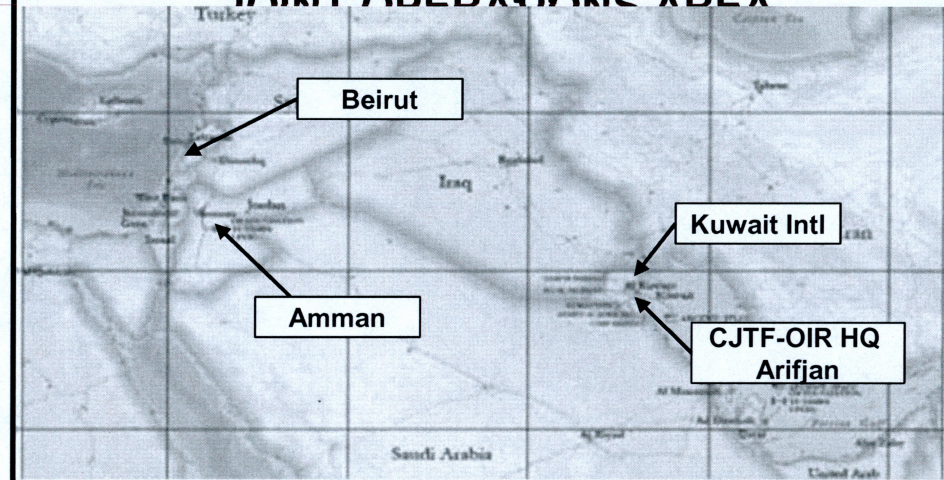

Concept of Support

Each CTAT will deploy with a very limited 1st line capacity and shall be expected to be self-sufficient through the maximum use of existing Host Nation services, new contracts and Technical Arrangements. JTF-I will provide 2nd and limited 3rd line support through its JTFSC.

CTAT members in both locations will initially live in hotel accommodations until suitable semi-permanent rental accommodations can be contracted. Surge teams accommodations will be either hotel or rental, depending on size and scope.

CTAT members in both locations will initially live in hotel accommodations until suitable semi-permanent rental accommodations can be sourced. Due to time and space considerations, JORDAN will initially require [redacted] and LEBANON will require [redacted]

Feeding. IMPs and feeding on the economy (per diem) will be used by the teams in both JORDAN and LEBANON.

Concept of Signals Support. Each CTAT will deploy with secure data and voice capability. The integral signaller will ensure intra-theatre and rear link comms.

Concept of Medical Support. Embassy recommended, Command Surg Approved, Western Accredited local medical services will be contracted for CTAT members in both JORDAN and LEBANON.

21 July 16 SECRET//

Canadian Joint Operations Command

A0639433_1-003939

15 (1)

Op IMPACT LoE 4 Recce Brief – Lebanon – J4

- **Real-Life Support (RLS):**
 - Contracted support for accn, transport and linguist
 - Contracted surge capability for training teams (RLS)
 - CTAT Log O – deployed contracting quals/experience
 - Accn – hotel (IOC), leased apt/house (FOC)
 - **Local hotels – within city of Beirut (IOC)**
 - Embassy recommended hotels – meets security requirements, low visibility
 - Many compliant hotels – approved SOW to present to industry
 - Experiences gathered from Op PROVISION (SOW development)
 - **Apt/houses (FOC) – located in northern Beirut**
 - Apt/houses (furnished + unfurnished)
 - CJOC JEngr – leasing real property
 - **Transport** (FOC)
 - [redacted] – approved SOW to present to industry
 - [redacted] – travel to [redacted]
 - Flexibility to rent larger vehs as required (SUVs, vans, buses, etc.) – CTAT Log O
 - [redacted] not recommended ([redacted] requirement for drivers TBC
 - LPO – local IT eqpt (cell phones, sim cards, printers, etc.)
 - IOC comms reqr established
 - Linguist/Translator
 - Further SOW development required
 - Define roles/responsibilities, attributes
- **Comments**
 - Material Accountability – Create and maintain DRMIS structures
 - Develop support dependency matrix – LoE 4 Op IMPACT between CTAT, Surge Tms, JTF-I, Embassy, HN, etc
 - CTAT and BPC Surge as self-sufficient as possible

Op IMPACT LoE 4 Recce Brief – Lebanon – J6

Information Exchange/Support Requirements

- **VOICE (Secure & Unsecure):**
 - Smart Phones (7) with local SIMS to be procured
 - CTAT Lead with Ottawa BB (1)
 - IRIDIUM Phones (2): secure sleeve
 - Hotel/residence landline and/or Embassy phone: secure OMNI
- **DATA (Classified & Designated):**
 - DWAN via T-DVPNI Laptops (7)
 - Full print/scan
 - [redacted] (next gen)
 - Print only
 - [redacted] Solution (CDA Office Amman only)
 - Full print/scan
 - [redacted] (Cdn Embassy)
- **SECURE VIDEO CONFERENCE (SVTC)**
 - CTAT & CDA Office
-
- **INTERNET**
 - Contracted fixed line and wireless capability
- **Sigs NCO**
 - Cpl to Sgt ACCIS CORE
 - Secondary Duty: Ops NCO
 - FG ROTO 0: CFJSR High Readiness pool
- **JTF-I J6**
 - Crypto Support
 - Installation/Support TAVs
 - Sustain equipment requirements
 - CIS Reports & Returns
- **Canadian Embassy**
 - White bag mail service
 - Short term storage
 - [redacted] email traffic directed to CTAT (accounts not required)
 - Engagement as necessary to facilitate transport of sensitive (crypto) or high value CIS equipment into HN
- **IOC Equipment Requirements**
 - FG from CJOC J6 Ops Stock & CFJSR HR Equipment
 - Local procurement in theatre during Recce and at TAT
- **Theatre Activation**
 - 1 x PY to enable transport and initial setup (10 days)
 - 4/5 PYs to install CSNI DASCO Solution CDA Jordan (5 days)
 - FG: Hybrid JTF-I J6 & CJOC/CFJSR

Op IMPACT LoE 4 Recce Brief – Project Approval Process Template

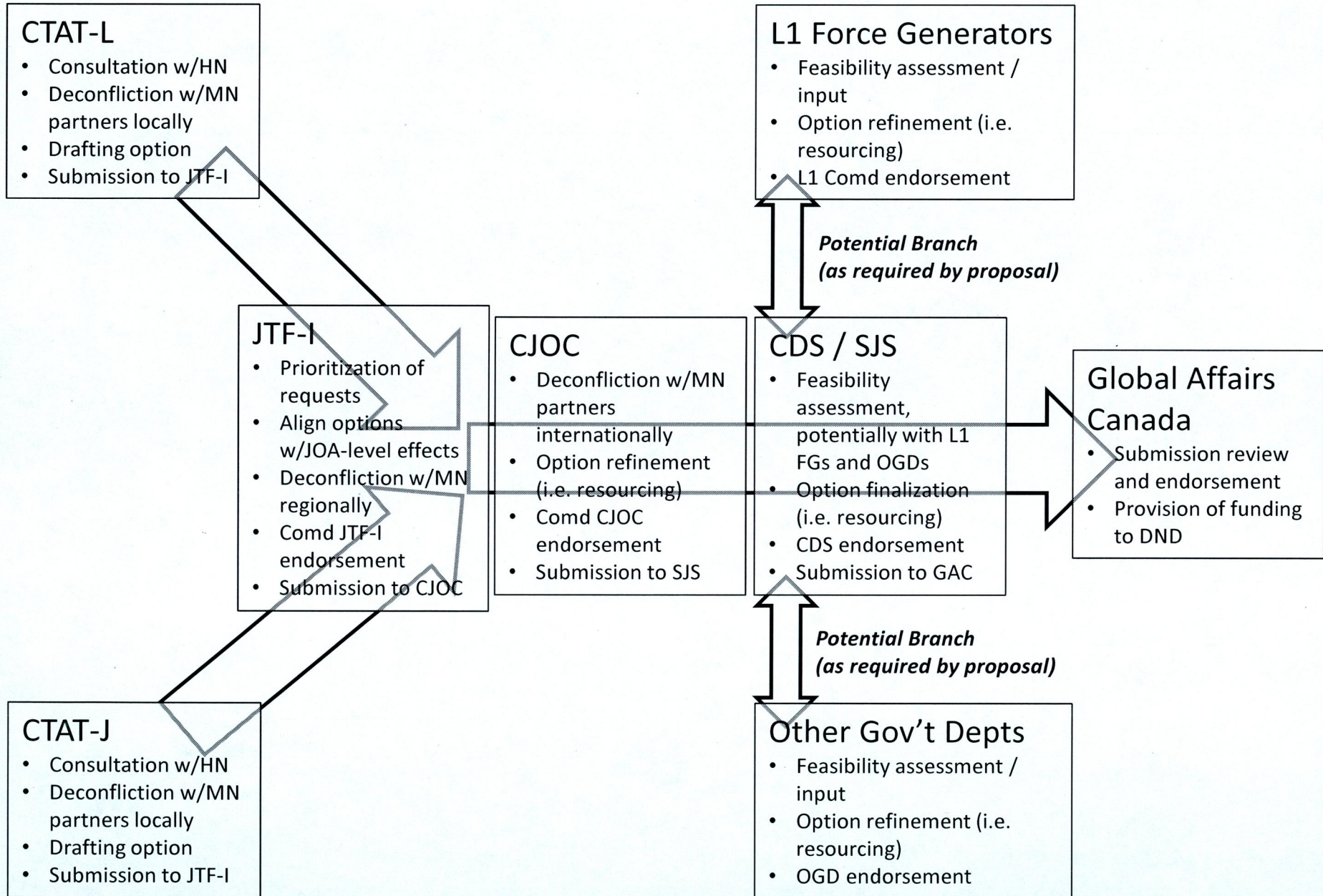

15(1)

Op IMPACT LoE 4 Recce Brief – Summary

CTAT OLR Recce – Outstanding Items

- Force Protection
 - Recommend
- Programming
 - Development of a project approval process
 - Timeliness: impact on confidence of LAF/JAF and credibility of CAF/GoC
 - CJOC ability to deliver GAC CTCBP
- Canadian specific relevant contributions synchronized with Allied efforts

Op IMPACT R2 DepI ERBIL

MAJOR PLANNING CONSIDERATIONS

- R2 costed at 4.4M for 6 months, ending 31 Mar 17
- MND announced 1 year commitment (dependant on the mission extension post-March 17)

MAJOR INFORMATION REQUIREMENTS

- Airlift requirements, pers and eqpt
- Camp construction timelines - ability to absorb R2 pers
- UK pers augmentation – 5 Pers, requirement to train with CAF R2 pers
- Requirement for a MOU with UK

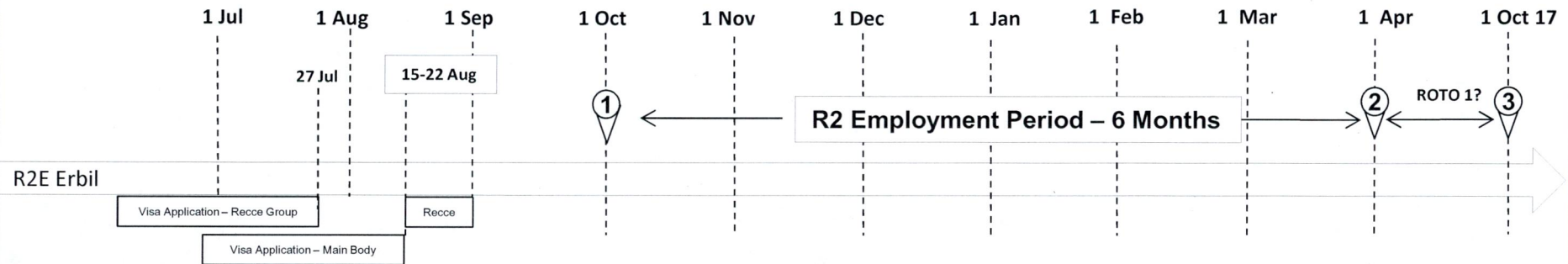

ONGOING ACTIVITIES

- Dip Note – Not required if CAF numbers remain below 450 in Iraq
- Visa Applications – **submitted** 27 Jul for Recce Party. To be **collected** NLT 15 Aug for remainder of R2 pers. 3 week process
- Tac Recce – Group composition J5ME, J6, JEng, HSS and 1 Cdn Fd H. **Recce party likely NMB 22 Aug** given visa application process
- TO&E –
 - Submitted to CJTF-OIR for validation, awaiting feedback
 - Being validated/refined and will be used to create CFTPO
 - JTF-I will validate to eliminate potential duplication of support tasks
 - TAV request a likely bridging measure prior to TO&E change request 10
- Pre-depl trg –
 - Coord ongoing CJOC J7/FG
 - Further refinement required on trg of UK embeds
 - Requirement for CAF pers to train on US CBRN eqpt to be left behind – preferred approach is to train in ERBIL
 - R2 eqpt is not required for trg and can be released for movement to ERBIL
- Pers Depl – Require further definition on movement of UK pers
- Eqpt Depl – Airlift requirements to be refined week of 25 Jul
- Camp Construction –
 - TF Engr/SET Comd to refine camp construction factors and deductions. Initial SET recce to ERBIL completed/PETAWAWA recce ongoing
 - Confirmation required of current state of infrastructure and engr work required to reach IOC.
 - If contracting or extensive work is required, timeline and work approval process may become a significant issue
- RiP of US R2 –
 - preferred approach is to have complete R2 deployed to ERBIL and synch RiP based on US movement

Op IMPACT
LoE 4 Build Partner Capacity
Jordan & Lebanon
Comd CJOC Update Brief

3 Aug 2016

This presentation is classified
SECRET//

15(1)

- Overview slide

Op IMPACT LoE 4 – General Observations

- Team manning potentially raised to **8** pers per location:
 - Potential addition of [redacted] drivers, [redacted] per team;
 - FG from [redacted] soldiers originally intended for depl in support of MLT
 - Pre-depl trg is completed with Bagdad as work environment.
 - CTAT-L still missing Int Op – FG solution being explored.
- CDS FRAGO 002 to Op IMPACT Directive 002:
 - Restraints: *“CAF will [redacted] except when in use during training and with the diplomatic consent of the host nation.”*
- ROE REQ:
 - CJOC currently working on ROE REQ.
 - Definition of [redacted] will require clarification as it refers to ‘ [redacted] within the [redacted] out [redacted] are identified.
- Lebanon HoM :
 - Differing views on approach to [redacted] in terms of [redacted]
 - [redacted] apparent from [redacted]
 - Resourcing issues with GAC [redacted]

Op IMPACT LoE 4 Risk Assessment

JORDAN RA – Refer to J2 placemat

Op IMPACT LoE 4 – Arrangements with JORDAN

- Technical Arrangements (TAs) with JOR to support CTAT deployments underway, for signature by Commander CJOC
-
- Existing DND/CAF legal arrangements for defence cooperation with Jordan
 - Defence Cooperation MOU – framework for defence and military cooperation
 - (2014)
 - Mutual Logistics Support Arrangement
- No legal concerns identified, however, note that legal arrangements are not legally binding

15(1)

Op IMPACT LoE 4 JORDAN Programming

- Following Strategic Needs Assessment (SNA) conducted in Jan-Feb 16, proposals/requests for support from allied partners operating within Jordan:
 - Initial/immediate proposal - Delivery of wet weather gear to the JAF QRF (about 1000 sets);
 - Mid-term proposal - Deployment of a battalion style logistics mentoring team to work with the JAF QRF; and
 - Jan-Mar 17 Provision of JTAC instructors to aid the US Military Assistance Program in the establishment of a permanent JTAC training school within Jordan.

- CTAT-J is considering additional opportunities for longer-term programming, though funding for some opportunities could not be drawn from CTCBP:
 - Women's Center of Excellence
 - Royal Corps of Engineers Training, to include C-IED

- CTAT-J is aware of road repair/construction requirements along the border, additional planning is required given project scale and that funding through CTCBP is not viable

Op IMPACT LoE 4 Recce Brief – Jordan – Force Protection



- Following [redacted] for Official Travel in Jordan (June 16), [redacted]
- [redacted] Zones: [redacted] AV, Sat Phone or PRSN;
- [redacted] Zones: [redacted], AV, Sat Phone or PRSN;
- [redacted] Zones: [redacted]
- [redacted] Zones: [redacted]
- and [redacted]
- [redacted]
- Most locations where CTAT and Surge Tms will [redacted]
- **Recommendations:**
- Follow [redacted]
- [redacted] Comms;
- [redacted]
- Logical reporting mechanism to JTF-I;
- [redacted] No [redacted], except at training location; and
- Recommended [redacted] measure [redacted]

15

15 (1)

15-1

Op IMPACT LoE 4 Risk Mitigation - JORDAN

Risk to mission	Probability	Impact	Mitigation
Loss of credibility (HN, GC, Allies) as a result of CAF inability to deliver substantive capacity building effects as a result of ineffective engagement with HN	[Redacted]	Critical	Active HoM enabling effort Streamline Programming approval process
Loss of credibility/enabling relationship with HN as a result of [Redacted] intent (i.e. [Redacted])	[Redacted]	Critical	Defence Collaboration Agreement, Technical Assistance Arrangement MOD/JAF oversight/input in programming initiatives
Loss of CAF credibility as a result of perceived or real [Redacted] to [Redacted]	[Redacted]	Critical	Vetting of recipient org or unit
Risk to Force	Probability	Impact	Mitigation
Degradation in operational capability as a result of [Redacted]	[Redacted]	Marginal	[Redacted]
Loss of life or serious threat to life [Redacted]	[Redacted]	Critical	[Redacted]
Loss of life as a result of [Redacted]	[Redacted]	Critical	[Redacted]
Loss of life as a result [Redacted]	[Redacted]	Catastrophic	[Redacted]
Reduced operational capability as a result of [Redacted]	[Redacted]	Marginal	[Redacted]

15 (1)

Op IMPACT LoE 4 Risk Assessment

LEBANON RA – Refer to J2 placemat

Op IMPACT LoE 4 LEBANON Programming

CTAT-L Projects

- Confirmed Project #1: Winter Clothing. Strong need in LAF, and Canada suited to assist. Project Proposal staffing started.
- Possible Projects
 - #2: Small Arms Trainer (SAT)
 - #3: First Aid (F/A) Trg
 - #4: Basic Recce Ptlmn Trg
 - #5: Tac-level CIMIC Tms
 - #6: "Simunition" Eqpt Hamat
 - #7: Counter-IED
 - #8: LAF Med Corps Eqpt, Org & Trg
 - #9: Engineer Eqpt
 - #10: Mtn Gear
 - #11: Lebanese ISF Professionalization

Op IMPACT LoE 4 – Arrangements with LEBANON

- Technical Arrangements (TAs) with LEB to support CTAT deployments underway, for signature by Commander CJOC
- No other existing DND/CAF legal arrangements for defence cooperation with Lebanon
- Risk associated with _____ for CAF members
- Currently no GC policy for strategic-level engagement with Lebanon – arrangement limited to mil-mil

- Legal primer

15-1

Op IMPACT LoE 4 Risk Mitigation - LEBANON

Risk to mission	Probability	Impact	Mitigation
Inability to deliver substantive capacity building effects as a result of ineffective engagement with HN (credibility with HN, Allies, GC)	[Redacted]	Critical	Active HoM enabling effort Streamline Programming approval process
Loss of credibility/enabling relationship with HN as a result of [Redacted]		Critical	Technical Assistance Arrangement MOD/LAF oversight/input in programming initiatives
Loss of CAF credibility with HN, GC, Allies as a result of perceived or real associations to hostile elements or criminal elements or listed elements		Critical	Vetting of recipient org or unit
Risk to Force	Probability	Impact	Mitigation
Degradation in operational capability as a result of [Redacted] and [Redacted]	[Redacted]	Marginal	[Redacted]
Loss of life or serious threat to life [Redacted]		Critical	[Redacted] control, [Redacted] implementation of [Redacted]
Loss of life as a result of [Redacted]		Critical	[Redacted]
[Redacted] as well as known [Redacted]		[Redacted]	[Redacted] personnel, [Redacted] of meeting venues [Redacted]
Loss of life as a result of [Redacted] against [Redacted] and or [Redacted]		Catastrophic	[Redacted] Beirut International Airport, [Redacted]
Reduced operational capability as a result of [Redacted]		Marginal	Mission [Redacted]

15(1)

Op IMPACT LoE 4 Recce Brief – Lebanon – Force Protection

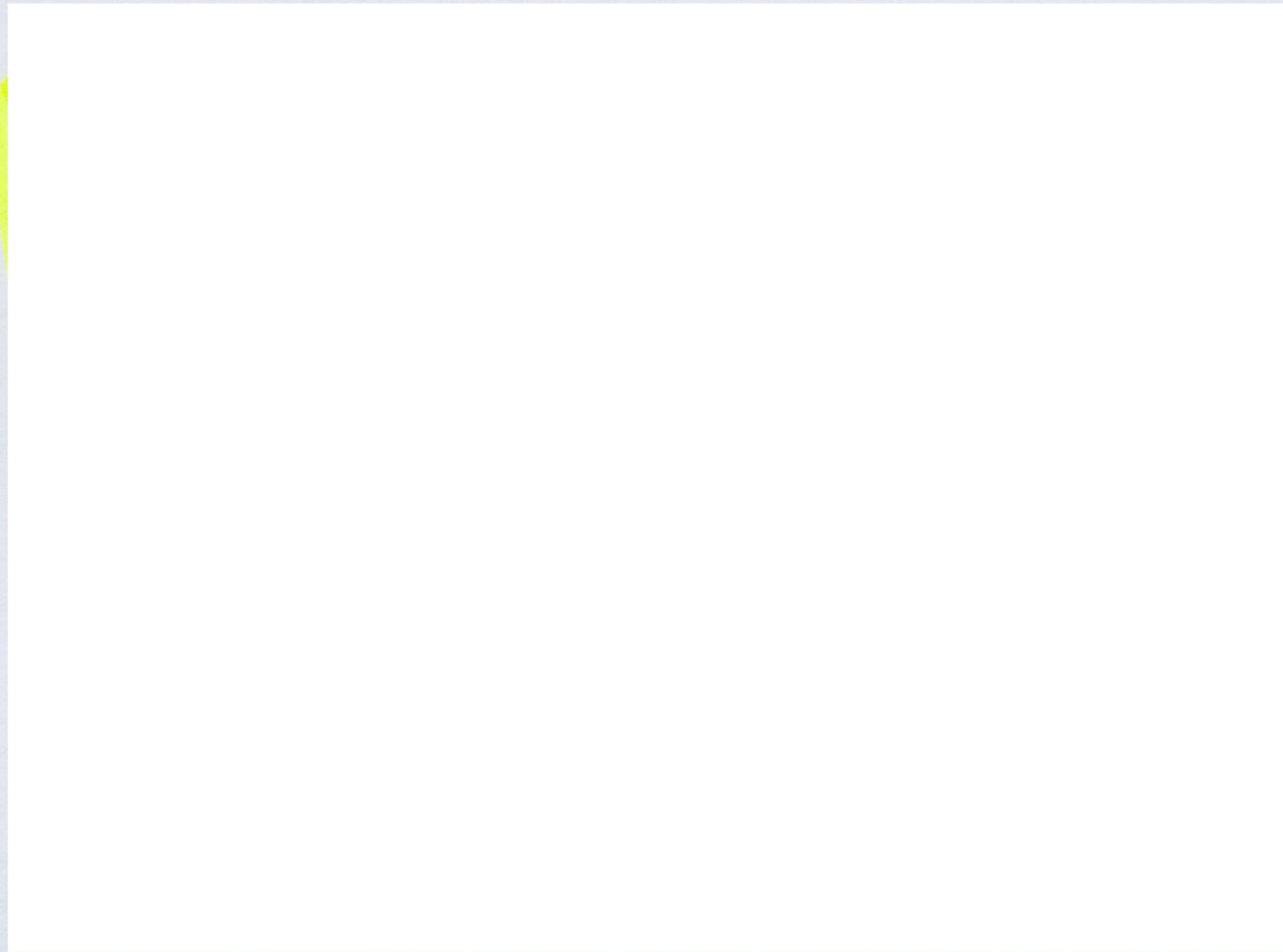

- Following [redacted] (April 16), from [redacted]
- Zone: [redacted]
- Zones: [redacted], AV, Sat Phone or PRSN [redacted]
- Zones: [redacted], AV, Sat Phone or PRSN [redacted]
- Zones: [redacted], AV, Sat Phone or PRSN [redacted]
- Zones: [redacted], FP measures IBC [redacted]
- Zones: [redacted]
- Almost all locations where CTAT and Surge Tms are [redacted]
- **Recommendations:**
- Follow [redacted] as much as possible;
- [redacted] Comms;
- Access to multiple AV;
- [redacted]
- Logical reporting mechanism to JTF-I;
- [redacted] except at training location; and
- Recommended measures [redacted]

- Recommendation slide for LEB

Page 3960

**is withheld pursuant to sections
est retenue en vertu des articles**

13(1), 15(1)

**of the Access to Information Act
de la Loi sur l'accès à l'information**

Op IMPACT – MLT

Update

Provisional Timeline

NOTE:

Acquisition = ADM(Mat)/PSPC Lead - FMS, timeline TBC

Integration = CA/US DoS lead,

Testing = CA/ADM(S&T) Lead,

Installation = DoS Lead, in theatre

SITREP

- "First in Class" veh integration complete, commenced testing
- Target end-Oct first in Baghdad

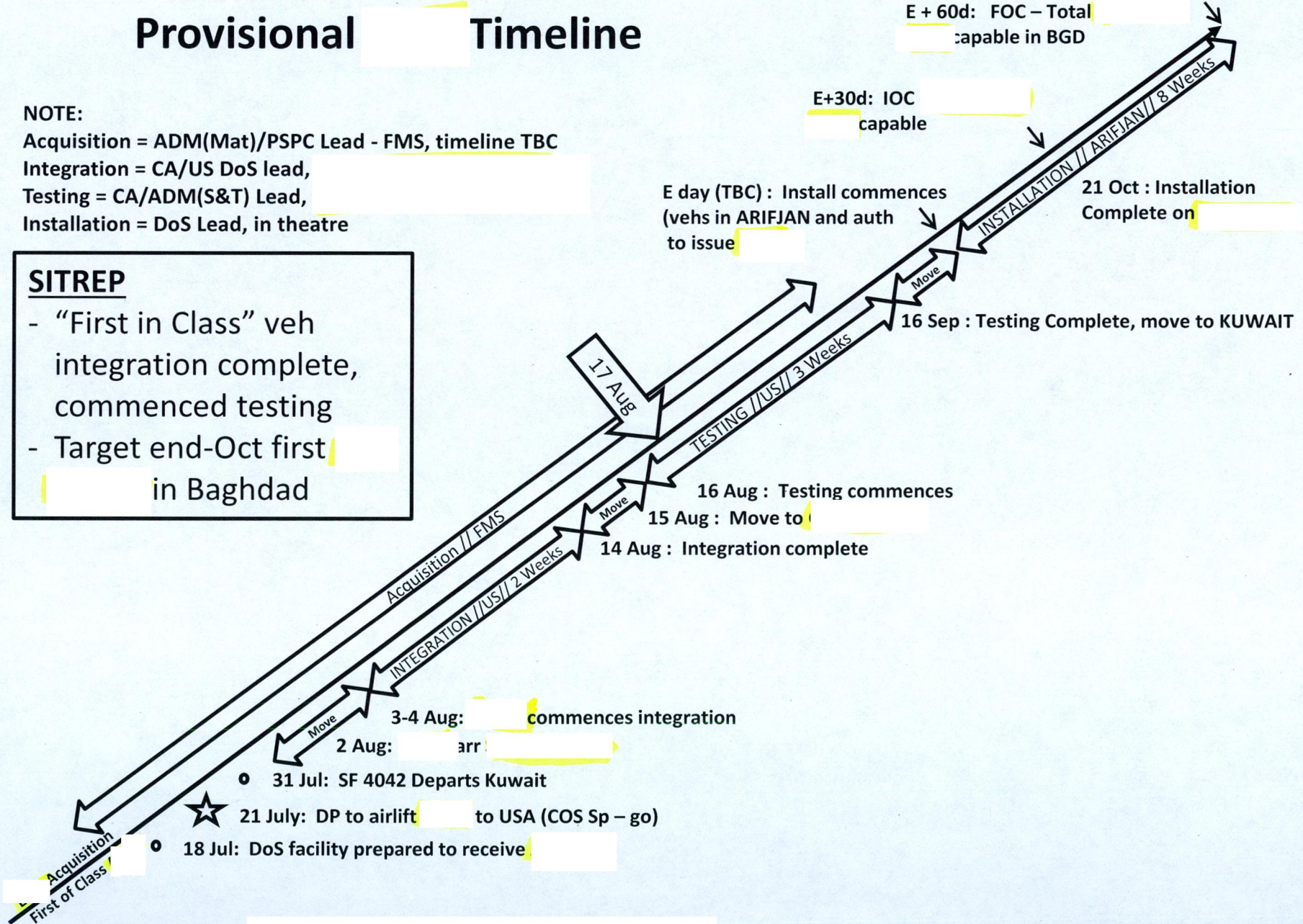

Op IMPACT – Erbil Camp Buila

SITREP

- Camp construction continues without issue
- Tac Avn and R2B main depl 26 & 28 Sep

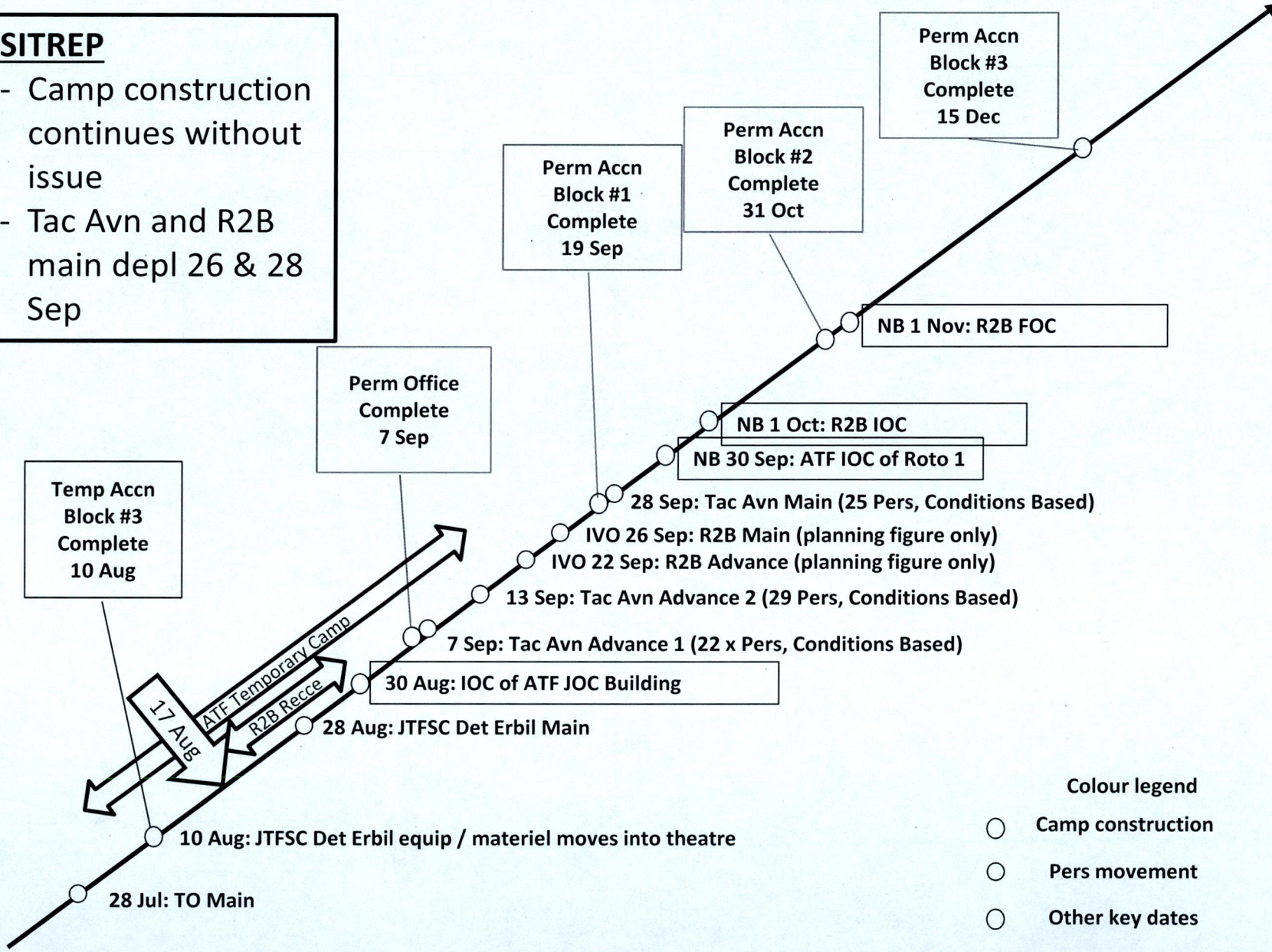

- Colour legend
- Camp construction
 - Pers movement
 - Other key dates

(154)

Page 3963

**is withheld pursuant to section
est retenue en vertu de l'article**

15(1)

**of the Access to Information Act
de la Loi sur l'accès à l'information**

CTAT PROJECT APPROVAL CONSIDERATIONS

Considerations

- CTAT is to identify options for GAC to move forward on
 - Process Flow CTAT → JTF-I → CJOC → SJS → GAC
- GAC Funding to come from GAC Vote 10, specifically Counter-Terrorism Capacity Building Program (CTCBP) funding
 - \$4.4M allocated per country through CTCBP, though not only funding option
- Cannot assume that procurement method will be DND/CAF
 - UNOps, CCC, Local Contracting etc
- Cannot assume that end product will be identical to current Canadian Military equipment / materiel

CTAT Jordan

- Wet Weather Clothing aimed for delivery in Nov 16
- Road Recce not before mid Sep

CTAT PROJECT SAMPLE APPROVAL TIMELINE

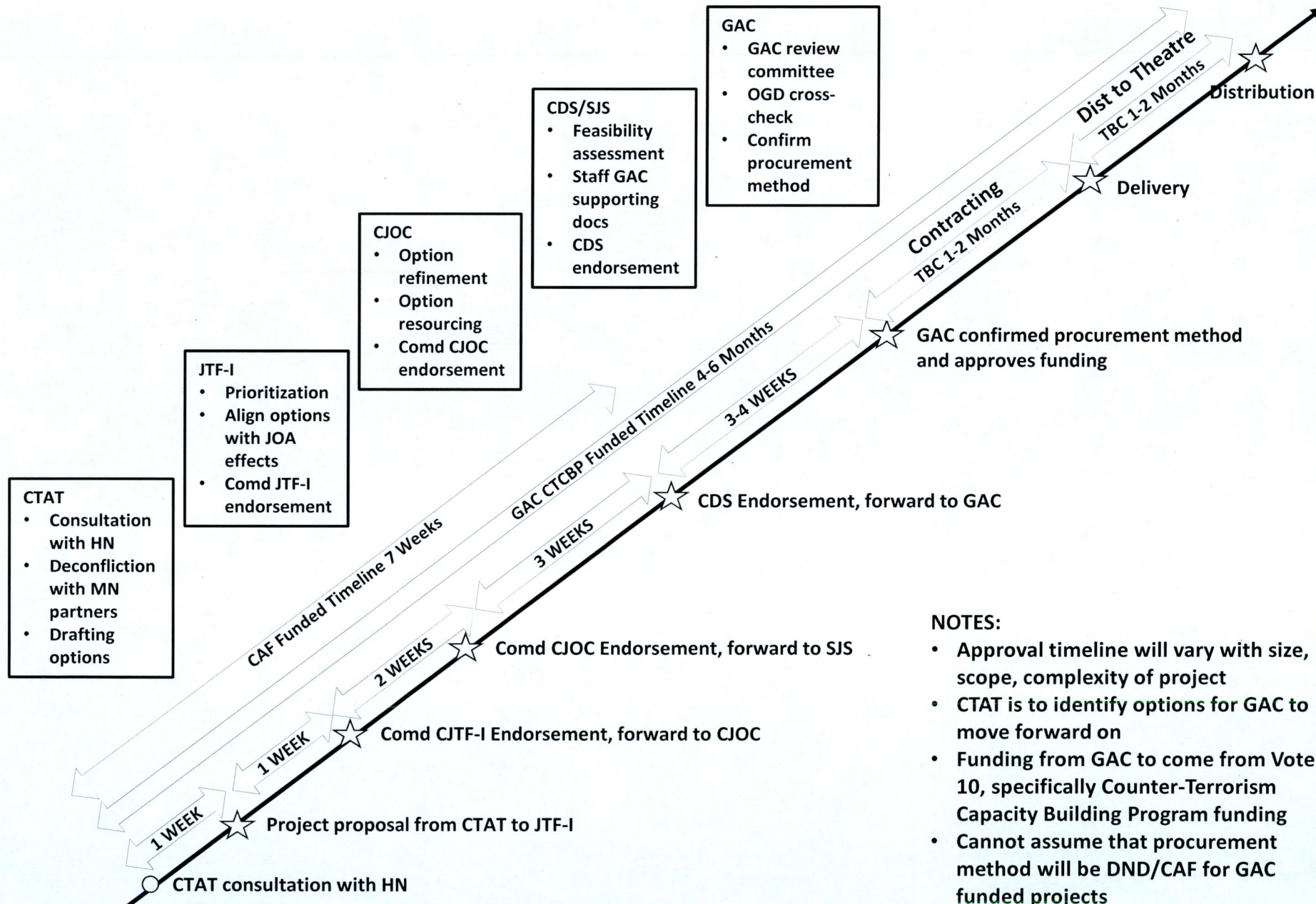

NOTES:

- Approval timeline will vary with size, scope, complexity of project
- CTAT is to identify options for GAC to move forward on
- Funding from GAC to come from Vote 10, specifically Counter-Terrorism Capacity Building Program funding
- Cannot assume that procurement method will be DND/CAF for GAC funded projects

CTAT INITIAL DEPLOYMENT

CURRENT SITUATION

- Initial 5 x posn in each CTAT filled and DAG Green
 - JOR visas aval on arrival; LEB all awaiting pp or visas
- In coord with CA for FG of 8 x FP/Dvrs (4 x per CTAT) – details next slide
- CJOC update to CDS on initial BPC projects 18 Aug 16

VISA/PASSPORT STATUS

POSN	JOR	LEB
Lead		
SM		
Int O		
Log O		
Sig		
FP x 8		

LEGEND

Can Depl Now
Visa or PP in Process
Visa Not Submitted

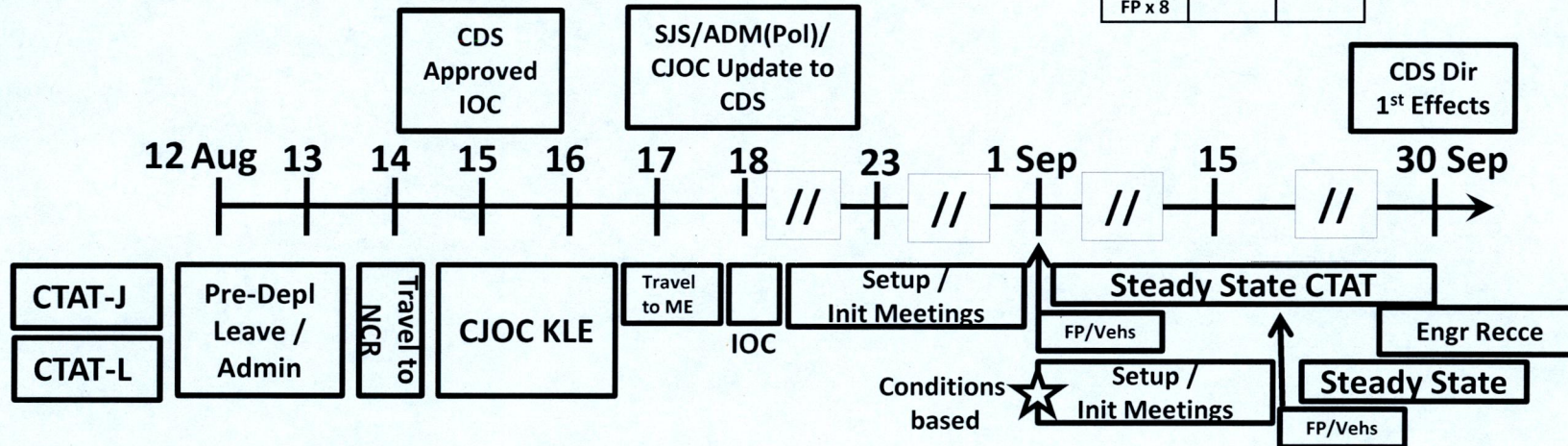

PROJECTS - JOR

- QRF Wet Weather Gear
 - Subm to SJS
- Border OP Access Rte
 - Planning Engr recce
- JTAC and Log Sp Trg
- Border OP QOL infra

COORD

- Movt:
 - CONOPs approved by Comd JTF-I
 - Veh / Pax/veh
 - MOVECON through JTF-I
 - with [redacted]
 - except for trg
 - PPE: [redacted] and [redacted] in go bag

C2

- OPCOM JTF-I
 - DSR and MOVECON
 - JTF-I KLE during RSOMI
- Comms
 - DWAN
 - CAN BB and Local Cell
 - Iridium
- Liaison
 - CJOC-J LNO
 - CDA JOR & A/CDA LEB

SUPPORT

- Accn: Has compliant bidders
- Veh: Has compliant bidders
- LEP/RLS/ [redacted] Contracts will be done by Log Os once depl

PROJECTS - LEB

- Winter Gear
 - Subm to SJS
- Mountain Gear/Trg
- Eqpt/Trg Initiatives

ISSUES

- LEB Visa delays
- LEB Embassy sp
- Project review process

Page 3967

**is withheld pursuant to section
est retenue en vertu de l'article**

15(1)

**of the Access to Information Act
de la Loi sur l'accès à l'information**

OP IMPACT LoE 4 – DETAILED PROJECT LIST

JORDAN

- From CDS FragO 002
 - Supporting the QRF with logistical support
 - Supporting the JAF Border Regt with trg, assistance and eqpt
 - NCO Trg
 - Women's Centre of Excellence
 - Aviation Trg
- From CDS visit to Jordan
 - ISR Eqpt (NVG, aerostats)
 - Improve border post access rte
- From OLR:
 - Wet Weather eqpt to QRF (1000 sets)
 - Logistics Mentoring team to QRF
 - EOD Eqpt and Trg
 - JTAC Trg

LEBANON

- From CDS FragO 002
 - Reinforce Land Border Regiments
 - Provide trainers to HAMAT TC
 - TCCC
 - Musketry
 - Reconnaissance
- From OLR
 - Winter clothing for LBR (10 000 sets)
 - Mountain equipment
 - Small Arms Trainer (SAT)
 - First Aid Training
 - Basic Recce Patrolman Training
 - Tac-level CIMIC Tm Training
 - "Simunition" Eqpt
 - Counter-IED Eqpt and Training
 - LAF Med Corps Eqpt, Org & Training
 - Engineer Equipmentt
 -

CTAT PROJECT APPROVAL CONSIDERATIONS

Considerations

- CTAT is to identify options for GAC to move forward on
 - Process Flow CTAT → JTF-I → CJOC → SJS → GAC
- GAC Funding to come from GAC Vote 10, specifically Counter-Terrorism Capacity Building Program (CTCBP) funding
 - \$4.4M allocated per country through CTCBP, though not only funding option
- Cannot assume that procurement method will be DND/CAF, may be UNOps, CCC, Local Contracting, etc.
 - CAF will be consulted on bidder selection before purchase
- Cannot assume that end product will be identical to current Canadian Military equipment / materiel
 - Requests will be tailored to be very specific to ensure correct products are sourced and potential compliant bidders identified early in the process

CTAT PROJECT SAMPLE APPROVAL TIMELINE

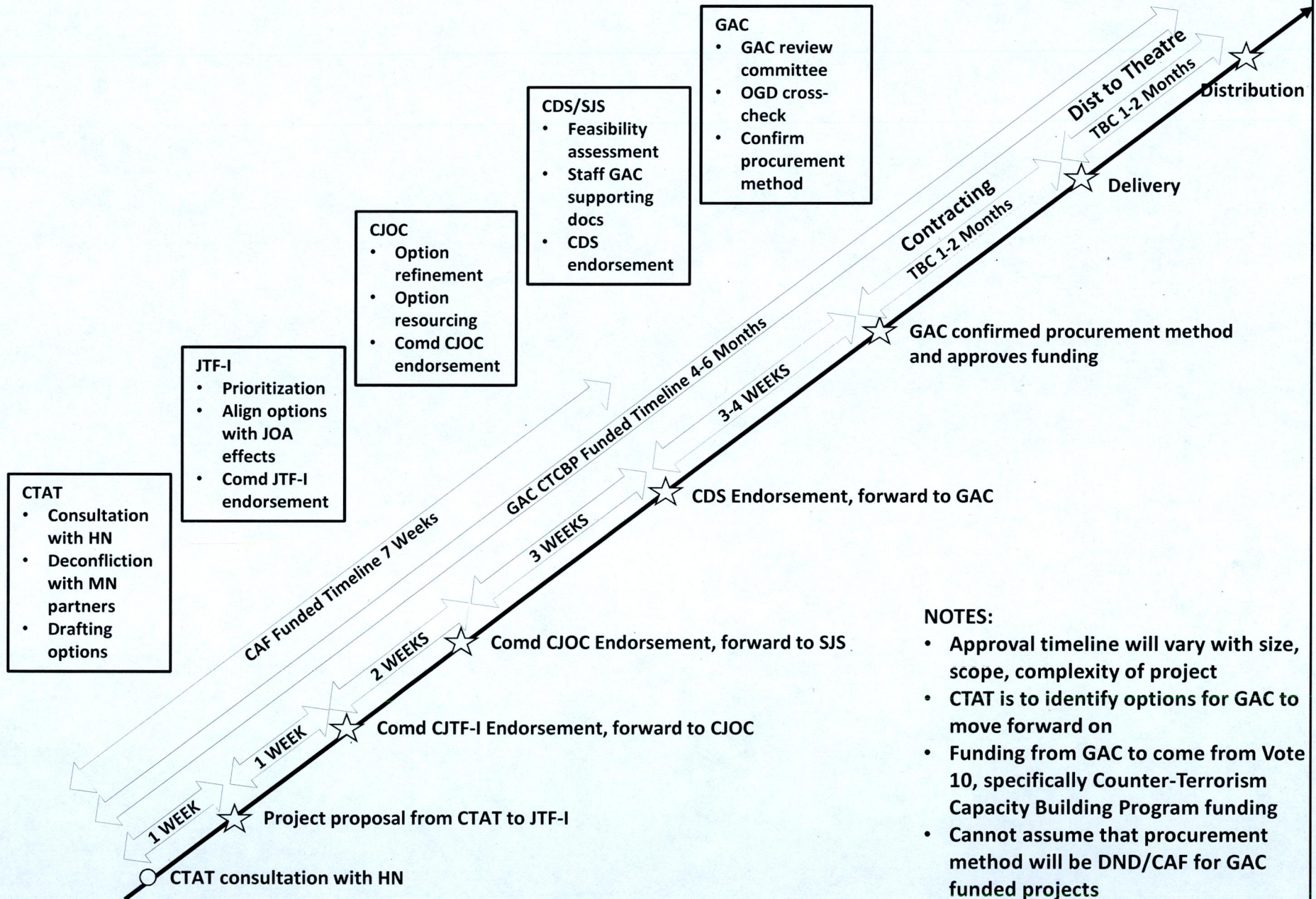

NOTES:

- Approval timeline will vary with size, scope, complexity of project
- CTAT is to identify options for GAC to move forward on
- Funding from GAC to come from Vote 10, specifically Counter-Terrorism Capacity Building Program funding
- Cannot assume that procurement method will be DND/CAF for GAC funded projects



Commander's Weekly Update

OP IMPACT

24 August 2016

AGENDA

- Personnel/Capability Update (J3 ME)
- CTAT Update (J3 ME)
- CTAT-J Reinforcement Update (J3 ME/J3)
- CTAT-J Assessment (J3 ME)
- Jordan Border Road (J5)
- Jordan Road Engr Pre-Recce (JEngr)
- CTAT Timeline (J5/DCOS Exped)
- Data (J3 ME/POLAD)
- Erbil Camp Build Update (COS Sp)
- MLT/ Update (COS Sp)
- MLT Placemat (J3 ME/J2/J3)
- CDS' RFIs (J3 ME)
- Comd's Direction

s.15(1)

Canadian Joint Operations Command

SECRET//

PERSONNEL AND CAPABILITY IN-FLOW

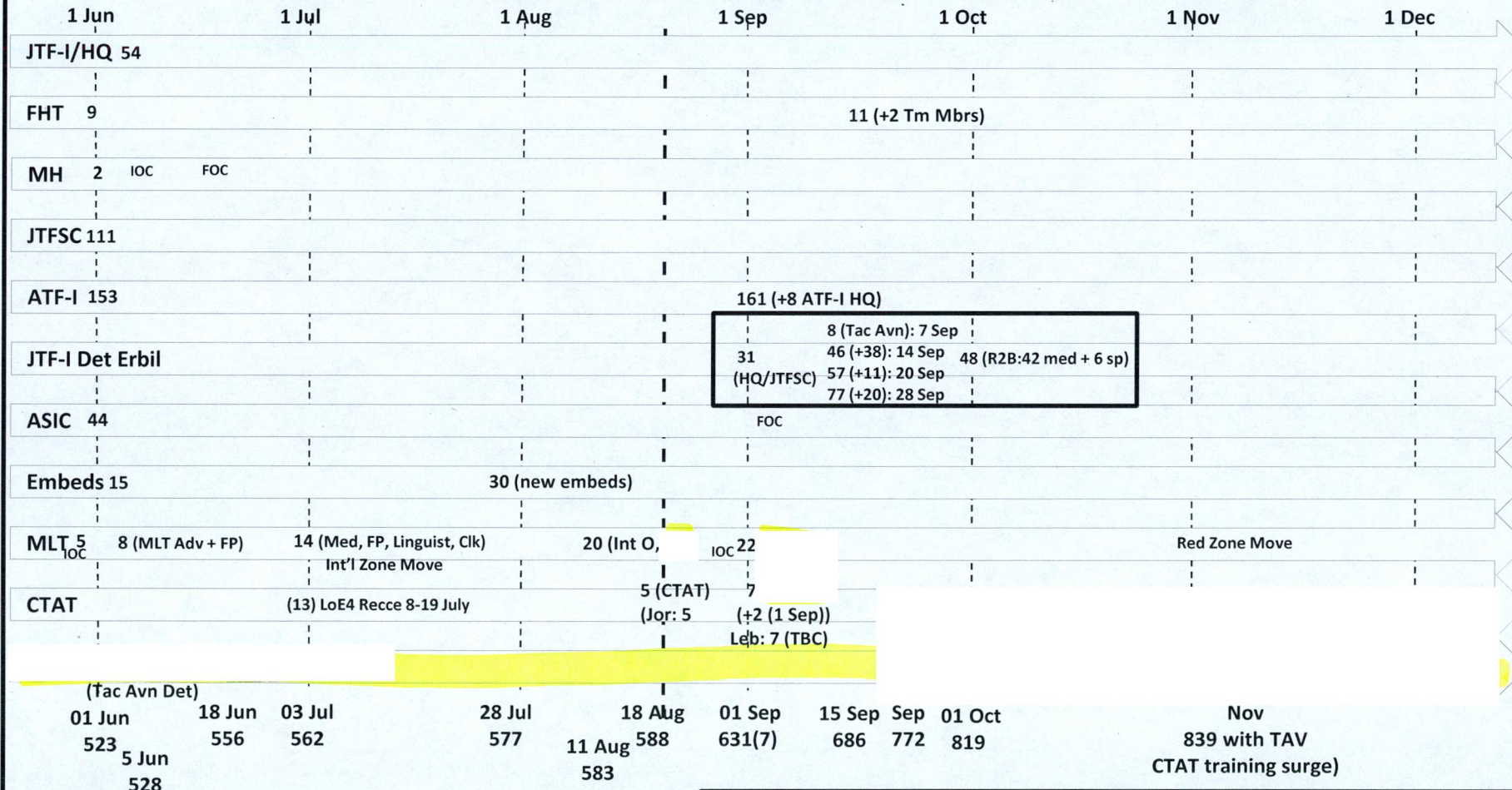

15/1

- RECENT MILESTONES**
- Capability
 - Theatre Opening Team (On-Going)
 - CTAT Jordan (Amman)
 - Authorities
 - TO&E change #9 (Tac Avn Det, JTF-I Det Erbil, ATF-I HQ)
 - Planning / movements
 - 1 x CC177 Delayed by 24 hrs (No significant impacts)

- UPCOMING ACTIVITIES**
- Capability
 - MLT Vehicle / [redacted] for testing)
 - FHT increase (2)
 - CTAT Lebanon (Visas)
 - JTF- I Det Erbil (Tac Avn Det TO&E, JTF-I Det Comd)
 - Planning
 - R2B Erbil Planning (Support Cell) and Recce (NMB 22 Aug – Visa)
 - TO&E Chg 10 (R2 Erbil)

CTAT UPDATE

LEGEND

Can Depl Now
Visa or PP in Process
Visa Not Submitted

VISA/PASSPORT STATUS

POSN	JOR	LEB
Lead	Deployed	
SM	Deployed	
Int O	Deployed	
Log O	Deployed	
Sig	Deployed	
	1 Sep 16	

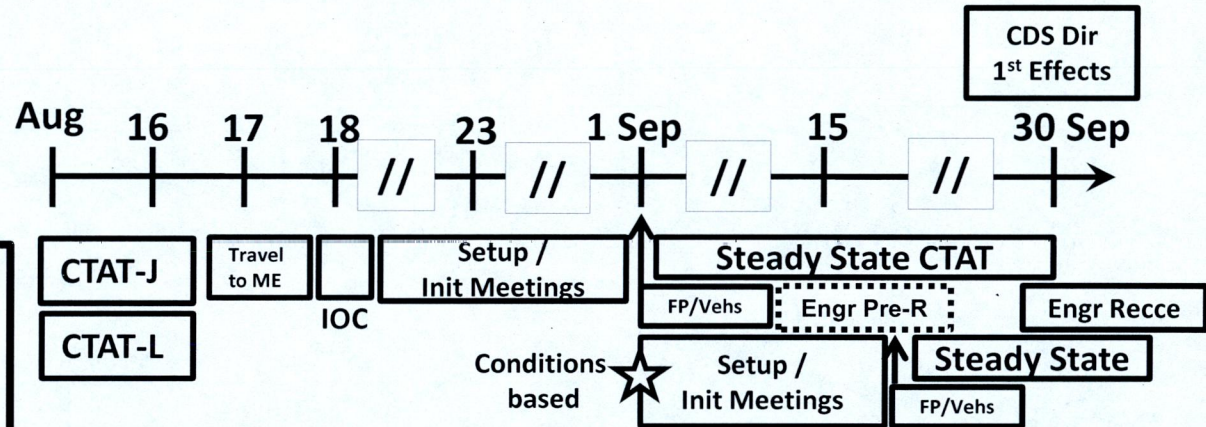

CURRENT SITUATION

- CTAT-L DAG Green, less passports or visas
- In coord with Can Army for FG of _____ Drivers (NB 15 Oct 16)

PROJECTS - JORDAN

- Pri 1 – Border OP Access Route
- Pri 2 – NVG's/ISR eqpt/trg
- Pri 3 – Border OP QOL Infra
- Pri 4 - QRF Wet Weather Gear
- Pri 5 - JTAC and Log Sp Trg

PROJECTS - LEBANON

- Pri 1 - Eqpt/Trg Initiatives
- Pri 2 - Mountain Gear/Trg
- Pri 3 - Winter Gear

COORD

- Movt:
 - CONOPs approved by Comd JTF-I
 - _____ Veh, _____ pax/veh
 - MOVECON through JTF-I
- Dress: Civ except for trg _____
- PPE: _____ in go bag

C2

- OPCOM JTF-I
- DSR and MOVECON
- JTF-I KLE during RSOMI
- Comms
 - DWAN
 - CAN BB and Local Cell
- Iridium
- Liaison
 - CJOC-J LNO
 - CDA JOR & A/CDA LEB

SUPPORT

- Accn: Has compliant bidders
- Veh: Has compliant bidders
- LEP/RLS
Contracts will be done by Log Os once depl

ISSUES

- LEB Visa delays
- LEB Embassy Support

CTAT-J REINFORCEMENT

SER	ORG	REMARKS
①	CJOC HQ	<ul style="list-style-type: none"> FE Project Management
②	JTF - I	<ul style="list-style-type: none"> C2
③	CDA - J & Embassy (2) (+2 on 11 Sep) (LCol & Maj)	<ul style="list-style-type: none"> Liaison & facilitation with Jordanian Govt & GAC
④	TF PROTEUS (1 - LCol) MC Space = 9	<ul style="list-style-type: none"> Regional engagements, oversight & coordination
⑤	CJOC - J LNO (Under Op FOUNDATION) (1 - LCol)	<ul style="list-style-type: none"> Coalition engagements via Build Partner Capacity
⑥	CJTf-OIR CJ7 (1 - BGen Anderson)	<ul style="list-style-type: none"> Coalition Training

PROJECTS
<ul style="list-style-type: none"> From CDS Frag O 002 <ul style="list-style-type: none"> Supporting the QRF with logistical support Supporting the JAF Border Regt with training, assistance and eqpt NCO Training Women's Centre of Excellence Aviation Training From CDS visit to Jordan <ul style="list-style-type: none"> ISR Eqpt (NVG, aerostats) Improve border post access route From OLR <ul style="list-style-type: none"> Wet Weather eqpt to QRF (1000 sets) Logistics Mentoring team to QRF EOD Eqpt and Training JTAC Training

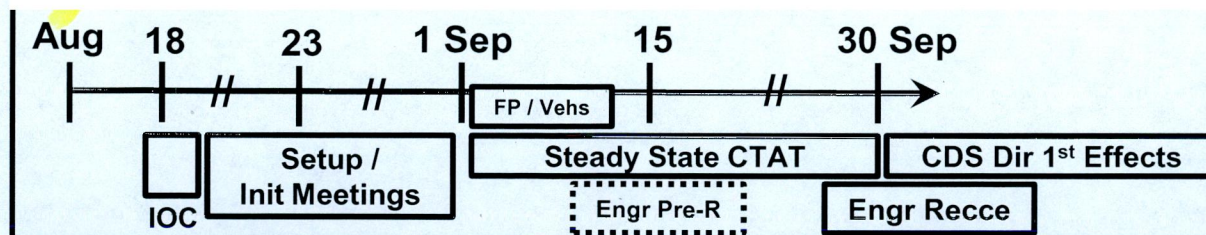

CTAT-J TM LDR – INITIAL ASSESSMENT

- Met JAF officials: Col [redacted] from the QRF, Col [redacted] from General Intelligence Department, and several internationals from the JICE. More meetings soon. JAF want to be very involved in the projects. I assess that this will result in some projects taking more time to get off the ground. 17
19(c)
- First quick delivery project will most likely be delayed. (QRF Rain Gear) Col [redacted] wants to see the exact rain gear we would bring in for his soldiers and approve it himself. This may be an extra step, but would allow the Col to have his buy in, as well as get them in a relatively short period of time (a few months) allowing delivery in time for the November rains.
- I believe the time taken to conduct ground level assessment will pay dividends. It may stretch out some delivery times, however it will prevent us from investing in projects that may not be worth investing in or require a different approach. A big case for this is the construction of roadways along the border with Syria. There are two areas that need to be looked at, both the road that links the towers along the Syrian border, and the road extension from [redacted]. The assessed long term utility of each of these two roadways, balanced with their direct result in contributing to border protection, will provide a better feel for which projects are worth pursuing. 25-
- Aim for next week is to link in with the CTAT steering committee, establish links with Royal Jordanian Engrs, assess EOD requests, and link in with [redacted] from the US to look at cooperative training options. 13
19(c)

Page 3977

**is withheld pursuant to section
est retenue en vertu de l'article**

15(1)

**of the Access to Information Act
de la Loi sur l'accès à l'information**

15.1

RECCE OBJECTIVES

- Confirm JAF requirements
- Gather data on the state of the road IOT define the feasibility, scope of work and ROM of costing and work flow.
- Confirm the capacity and capability of JAF Engr and local contractors (aggregate, rental of Heavy Eqpt and construction)
- Establish liaisons (with JAF, potential contractors & provider)
- Investigate
- Estimate for Engineer Work

Pre-Engr (TAV) Recce Composition (5)

- Maj T.W. [redacted] (Lead, CJOC HQ J Engr)
- 2 x Hor Constr SMEs (CFJOSG 1 ESU)
- 1 x Hy Eqpt SME (CFJOSG 1 ESU)
- 1 x Survey Tech (CFJOSG 1 ESU)

CTAT Support

- [redacted] coord
- Movement
- Linguistic/liasion
- Log O (contracting assessment, reach back J4 contracts)

CONCERNS / ISSUES

- JAF support required
- CAF capability limitations (Cbt road only)
- [redacted]
- JAF Engr/Local contracting capacity & capability

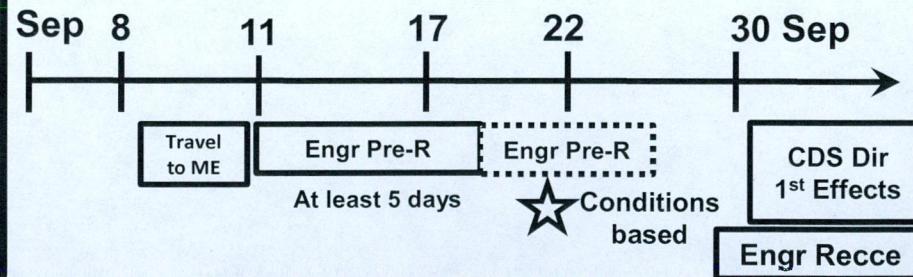

CTAT TIMELINE

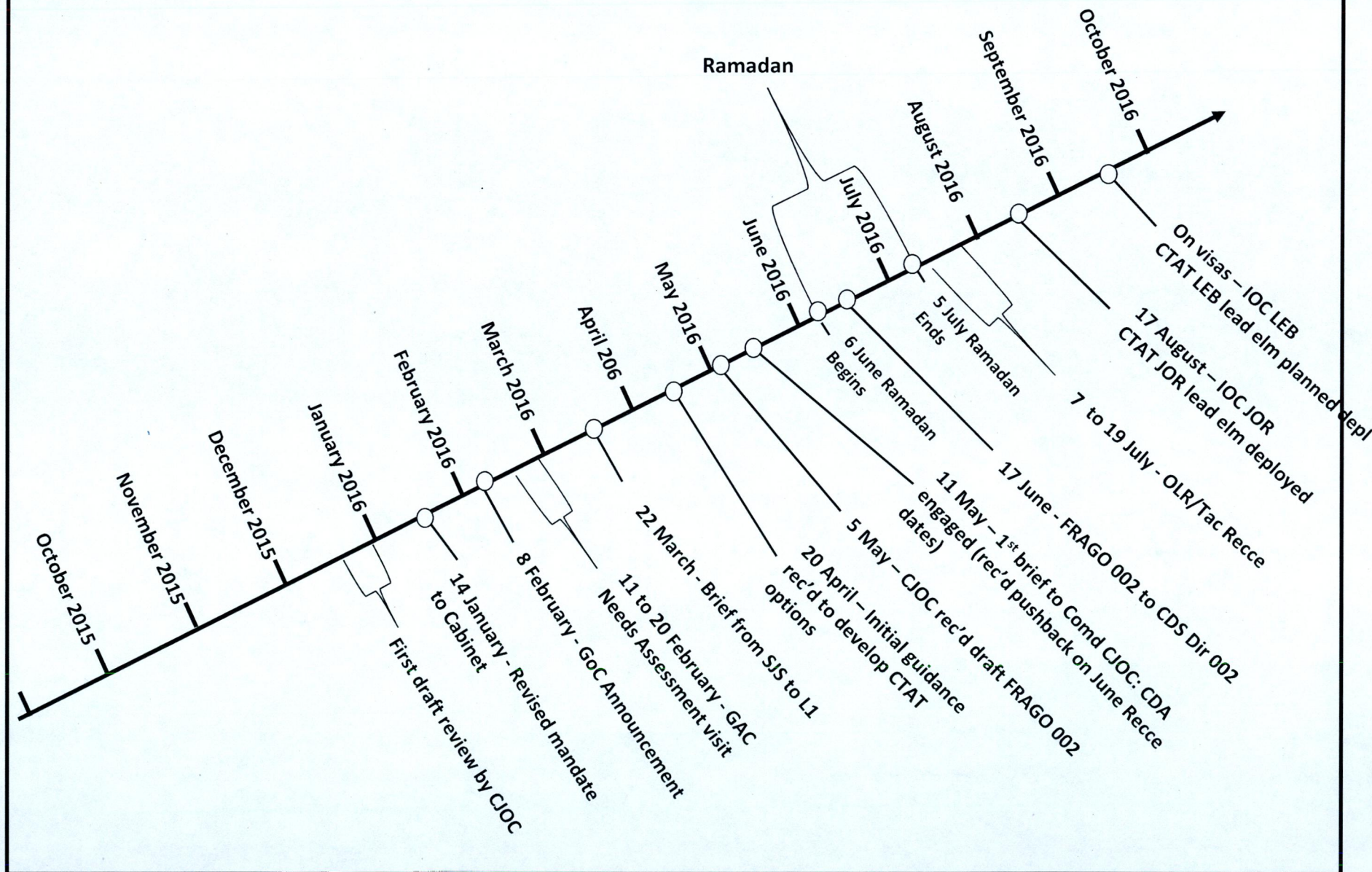

TAC AVN TO&E

Problem Statement (JFACC / 1 Wing) - Sustain a combat capable Tac Avn Det in support of Op IMPACT, be postured to sustain second deployed location (Africa TBC), while minimizing impact to its FP&R and YFR allocation

MACRO RCAF MRP

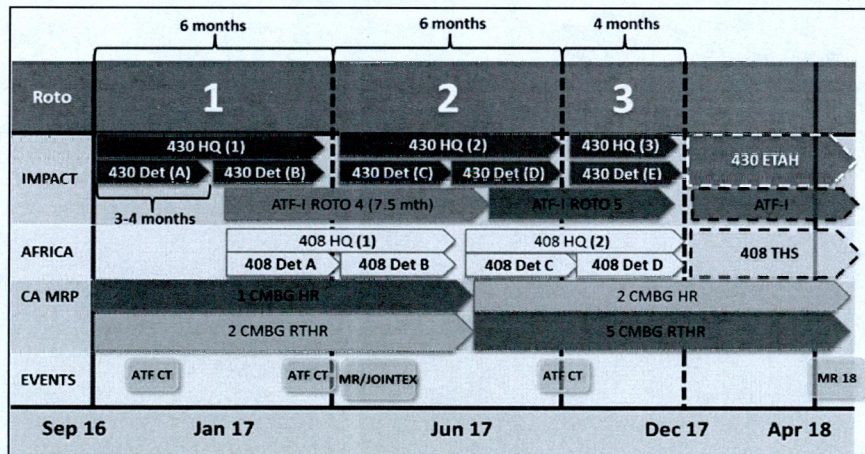

MICRO RCAF OP IMPACT OPTION

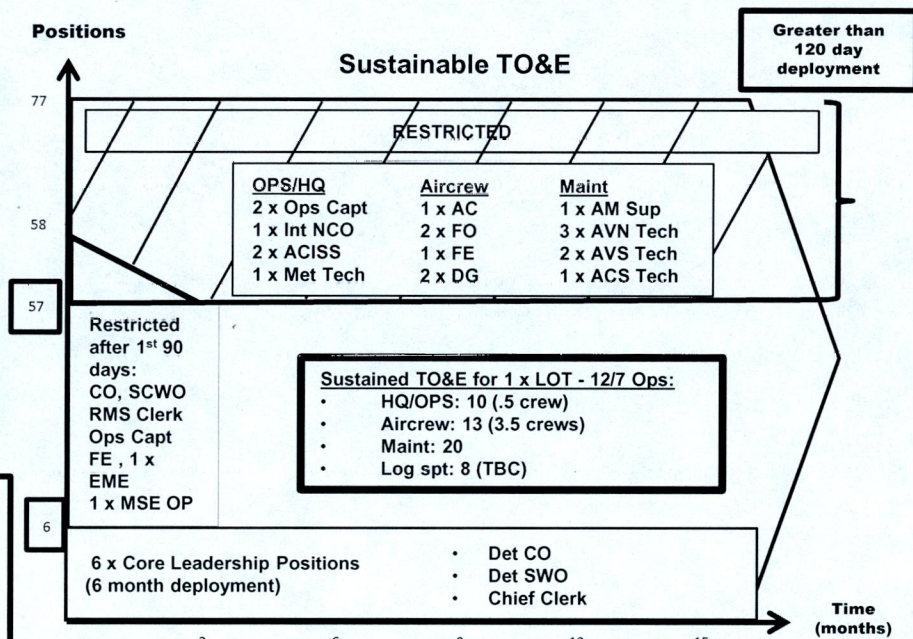

ATF FG: Shifting to 7/8 months for ATF/Fleet Alignment

RECOMMENDATIONS

- Approve the TO&E reduction (77 to 57) by Comd 1 CAD
- Restrict the new empty TO&E positions (Increased flexibility)
- Support the 90 day deployment cycle for the Tac Avn Det
 - RCAF have to sustain FG of a Tac Avn Det until Dec 17
- Reassess if operational tempo significantly increases for prolonged period of time

Background

- Initial CONOPs -
- Line of Task (LOT)
- CH146

Current Ops Tempo

- Weekly flying rate of
- Mission: Troop/VIP transport (primary)
 - Deliberate Ops: Secondary for casevac standby and

Assumptions

- 12/7 Flying Ops: 1x 8 hr LOT (2x CH146)
- Tac Avn Det [core] leadership will deploy for 6 - 8 months
- 1 Wing will fill ATF HQ A5/OSE and Los
- Enable sustainment until 31 Dec 17

Manning

- Unit establishment can only FG / Sustain 2 x Rotos with a 77 pers TO&E (reconstitution period)
- Short rotos (90 days) permit same pers to redeploy for a 2nd 90 day roto within 12 months

Advantages

- Indefinitely sustainable (incl simultaneous deployments)
- Reduced risk to execute YFR allocation (unit flexibility)
- Reduces DAG RED risk / Reduces Repat Risk
- Optimized TO&E/reduced requirements for augmentation (no HLTAs)

Page 3981

**is withheld pursuant to section
est retenue en vertu de l'article**

15(1)

**of the Access to Information Act
de la Loi sur l'accès à l'information**

ERBIL CAMP BUILD

SITREP

■ No change

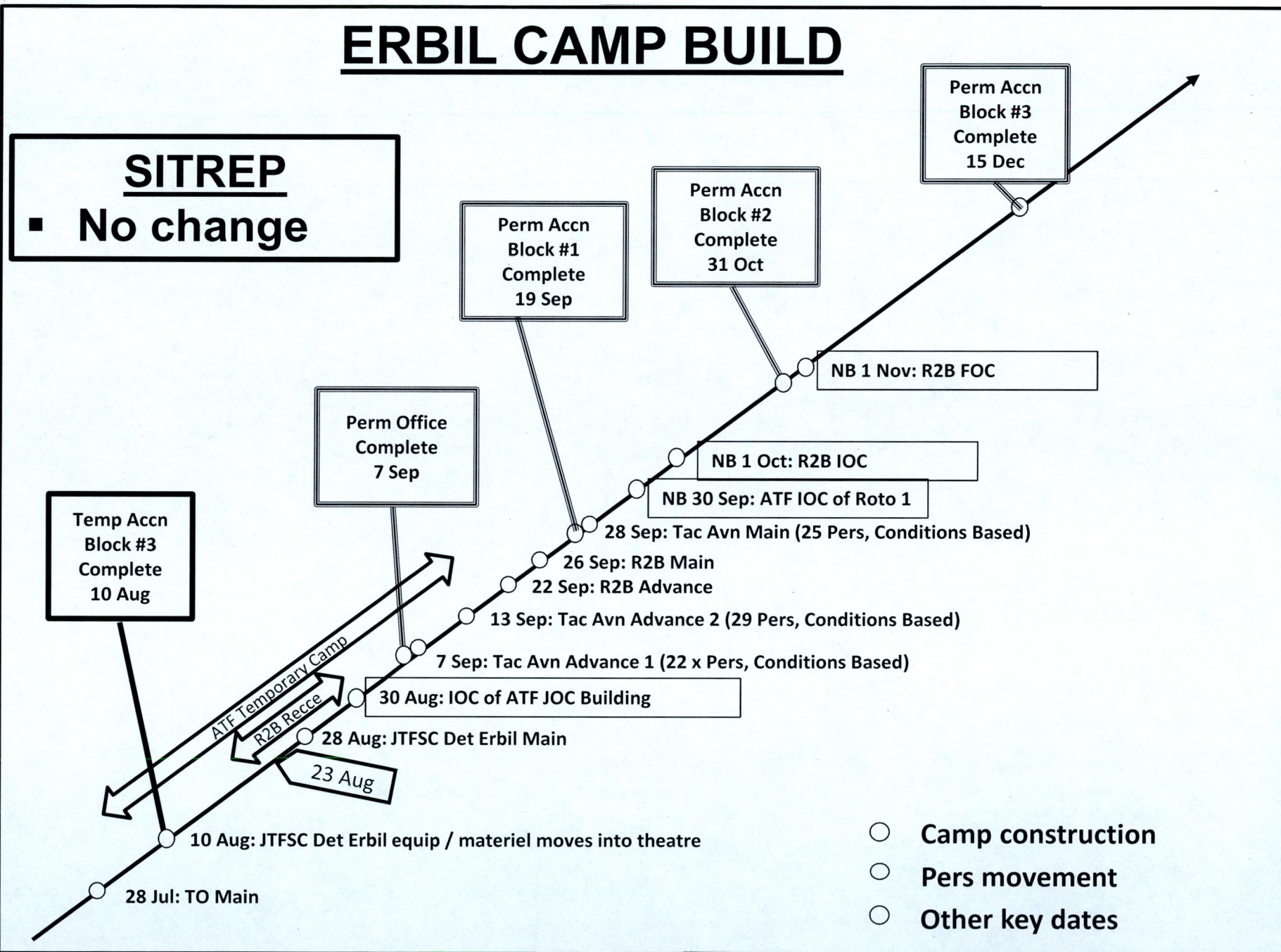

- Camp construction
- Pers movement
- Other key dates

MLT UPDATE

Provisional Timeline

NOTE:

Acquisition = ADM(Mat)/PSPC Lead - FMS, timeline TBC
Integration = CA/US DoS lead,
Testing = CA/ADM(S&T) Lead,
Installation = DoS Lead, in theatre

SITREP
▪ **No change**

E + 60d: FOC – Total
capable in BGD

E+30d: IOC
capable

E day (TBC) : Install commences
(vehs in ARIFJAN and auth
to issue

21 Oct : Installation
Complete on

16 Sep : Testing Complete, move to KUWAIT

23 Aug

TESTING // US // 3 Weeks

16 Aug : Testing commences

15 Aug : Move to

14 Aug : Integration complete

INTEGRATION // US // 2 Weeks

3-4 Aug: commences integration

2 Aug:

31 Jul: SF 4042 Departs Kuwait

21 July: DP to airlift to USA (COS Sp – go)

18 Jul: DoS facility prepared to receive

Acquisition
First of Class

13-1

MLT PLACEMAT – CONOP DELEGATION

MLT DIR MACRO ASSESSMENT

- Atmospherics
- Trends
- Etc.

MEDICAL

- Medical Assets / Resources
 - Integral
 - Facilities
- C2
 - Reporting Chains
 - Important Numbers
- Evac Plan
 - Pri 1/Pri 2
 - Pri 3
 - Strat

COMMS PLAN

- [redacted] at UIII during movt. Comms is maintained with US [redacted] through the UIII Situation Room (Ops Center). Direct comms with the RSO via cell.
 - P – Radio comms within convoy – Motorola APX
- A – Iridium Sat Phones
- C – Local Cell Phone Secure App (What's App)
- E – Blackberry

5y

Scenarios / Risks	Probability	Severity	Risk to Force	Risk to Mission	Mitigation Measures	Residual Risk
Harassment at Checkpoints	Frequent	Negligible	Moderate	JTF-I to Fill	MLT to Fill for all scenario's	
Mass Demonstrations - not directed at Coalition	Likely	Marginal	Moderate	JTF-I to Fill	However, at a minimum, the following must be covered	
Mass Demonstrations - directed at Coalition	Seldom	Critical	Moderate	JTF-I to Fill	Vehicle Plates	
Sectarian Violence / Petty Crime	Occasional	Marginal	Moderate	JTF-I to Fill	Window Tinting	
Low yield IED - ISIL	Likely	Catastrophic	High	JTF-I to Fill	Check Point Intervention	
[redacted]	Seldom	Catastrophic	High	JTF-I to Fill	[redacted]	
[redacted]	Occasional	Marginal	Moderate	JTF-I to Fill	[redacted]	
Hostile Intelligence Service Collection	Frequent	Negligible	Moderate	JTF-I to Fill	Other Nationalities SOPs	
High Yield IED	Seldom	Catastrophic	High	JTF-I to Fill		
Complex Ambush	Seldom	Catastrophic	High	JTF-I to Fill		
Kidnapping	Occasional	Critical	High	JTF-I to Fill		
Anti-Coalition IO Campaign	Occasional	Critical	High	JTF-I to Fill		
[redacted]	Unknown	Catastrophic	SEVERE	JTF-I to Fill		

15-1

CDS RFIs – 23 AUG 16

- 15-1
▪ CJ7 thoughts on effects achieved to date by the MLT
 - The Process for the Police Forces is now progressing
 - In the process of formalizing the MoD support to Mol
 - Training and real life support at the Training Sites
 - The Police Steering Committee efforts are ongoing and progressing
 - Hosting a Police Training Conference in September
 - All Police Training Efforts are properly synchronized and coordinated
- 17
▪ C2 of the Tac Avn Det vs Det Erbil
 - CO of Tac Avn Det = LCol
 - CO of JTF-I Det Erbil = Lcol
- Acceleration of CTAT-J effects. Will an Engr TAV prior to the Recce advance the project desires?
 - Yes. As briefed on slide 7
- Media visit dates to OP IMPACT require to be deconflicted with VVIP itineraries
 - Programmed Media Visit ~ 2 to 10 Oct 16 (Depending on PM Visit)
 - Programmed GG Visit in Oct 16 = Cancelled
 - Tentative PM Visit = Early Oct (Not confirmed via PMO yet)



Commander's Weekly Update

OP IMPACT

31 August 2016

AGENDA

- **Indications and Warnings Update (J2)**
- **Personnel & Capability Update (J3 ME)**
- **CTAT Update (J3 ME)**
- **CTAT-J Reinforcement Update (J3 ME)**
- **CTAT-J Road Engr Pre-Recce (JEngr)**
- **RCAF FG: Tac Avn TO&E and ATF Tour Length (J3 ME)**
- **Potential CC150 Capability (JFACC LO)**
- **Arifjan Benefits (J3/J1)**
- 15-1 ▪ **Erbil Camp Build Update (COS Sp Ops)**
- **MLT Update (COS Sp Ops)**
- **MLT Placemat (J3 ME/J2/J3)**
- **Comd's Direction**

PERSONNEL AND CAPABILITY IN-FLOW

	1 Jun	1 Jul	1 Aug	1 Sep	1 Oct	1 Nov	1 Dec
JTF-I/HQ 53/1							
FHT 9					11 (+2 Tm Mbrs)		
MH 2 IOC FOC							
JTFSC 105/6							
ATF-I 142/11				150/11 (+8 ATF-I HQ)			
JTF-I Det Erbil				31 (HQ/JTFSC) 8 (Tac Avn): 7 Sep 46 (+38): 14 Sep 57 (+11): 20 Sep 48 (R2B:42 med + 6 sp) 77 (+20): 28 Sep			
ASIC 43/1				FOC			
Embeds 15			30 (new embeds)		2 (CSEC & ITAC)		
MLT _{IOC} 5	8 (MLT Adv + FP)	14 (Med, FP, Linguist, Clk) Int'l Zone Move	20 (Int O, CP)	IOC 22 (+2 FP)		Red Zone Move	
CTAT		(13) LoE4 Recce 8-19 July	5 (CTAT) (Jor: 5)	7 (+2 FP) (+2 (1 Sep))			

(Tac Avn Det)	01 Jun	18 Jun	03 Jul	28 Jul	18 Aug	01 Sep	15 Sep	01 Oct	Nov
	506(525)	537(556)	543(562)	558(577)	569(588)	612(631)	660(679) Sep	800(819)	820(839)*
	5 Jun 509(528)			11 Aug 564(583)			746(765)		Mil(total) positions

RECENT MILESTONES

- Capability
 - Theatre Opening Team (On-Going)
- Authorities
 - CTAT Tasking Order
 - CTAT Engr Recce Tasking Order
- Planning / movements
 - CTAT-J – JEngr Recce

UPCOMING ACTIVITIES

- Capability
 - MLT Vehicle _____ (or testing)
 - FHT increase (2)
 - CTAT Lebanon (Visas)
 - JTF- I Det Erbil
- Planning
 - R2B Erbil Planning
 - TO&E Chg 10 (R2B Erbil)

CTAT UPDATE

LEGEND

Can Depl Now
Visa or PP in Process
Visa Not Submitted

VISA/PASSPORT STATUS

POSN	JOR	LEB
Lead	Deployed	
SM	Deployed	
Int O	Deployed	
Log O	Deployed	
Sig	Deployed	
FP x 8	1 Sep 16	

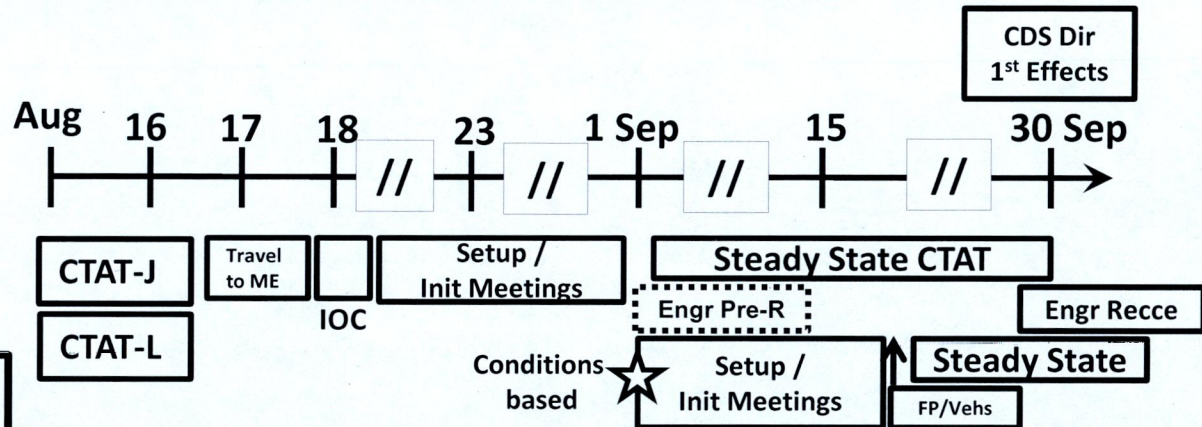

CURRENT SITUATION

- FG of / Drivers (NB 15 Oct 16)
- CTAT-L Moved to 7 days NTM

PROJECTS - JORDAN

- Pri 1 - Border OP Access Route
- Pri 2 - NVG's/ISR eqpt/trg
- Pri 3 - Border OP QOL Infra
- Pri 4 - QRF Wet Weather Gear
- Pri 5 - JTAC and Log Sp Trg

PROJECTS - LEBANON

- Pri 1 - Eqpt/Trg Initiatives
- Pri 2 - Mountain Gear/Trg
- Pri 3 - Winter Gear

COORD

- Movt:
- CONOPs approved by Comd JTF-I
- pax/veh through JTF-I
- PPE: in go bag

C2

- OPCOM JTF-I
- DSR and MOVECON
- JTF-I KLE during RSOMI
- Comms
- DWAN
- CAN BB and Local Cell
- Iridium
- Liaison
- CJOC-J LNO
- CDA JOR & A/CDA LEB

SUPPORT

- Accn: Has compliant bidders
- Veh: Has compliant bidders
- LEP/RLS/ASUV: Contracts will be done by Log Os once depl

ISSUES

- LEB Visa
- LEB Embassy Support

CTAT-J REINFORCEMENT

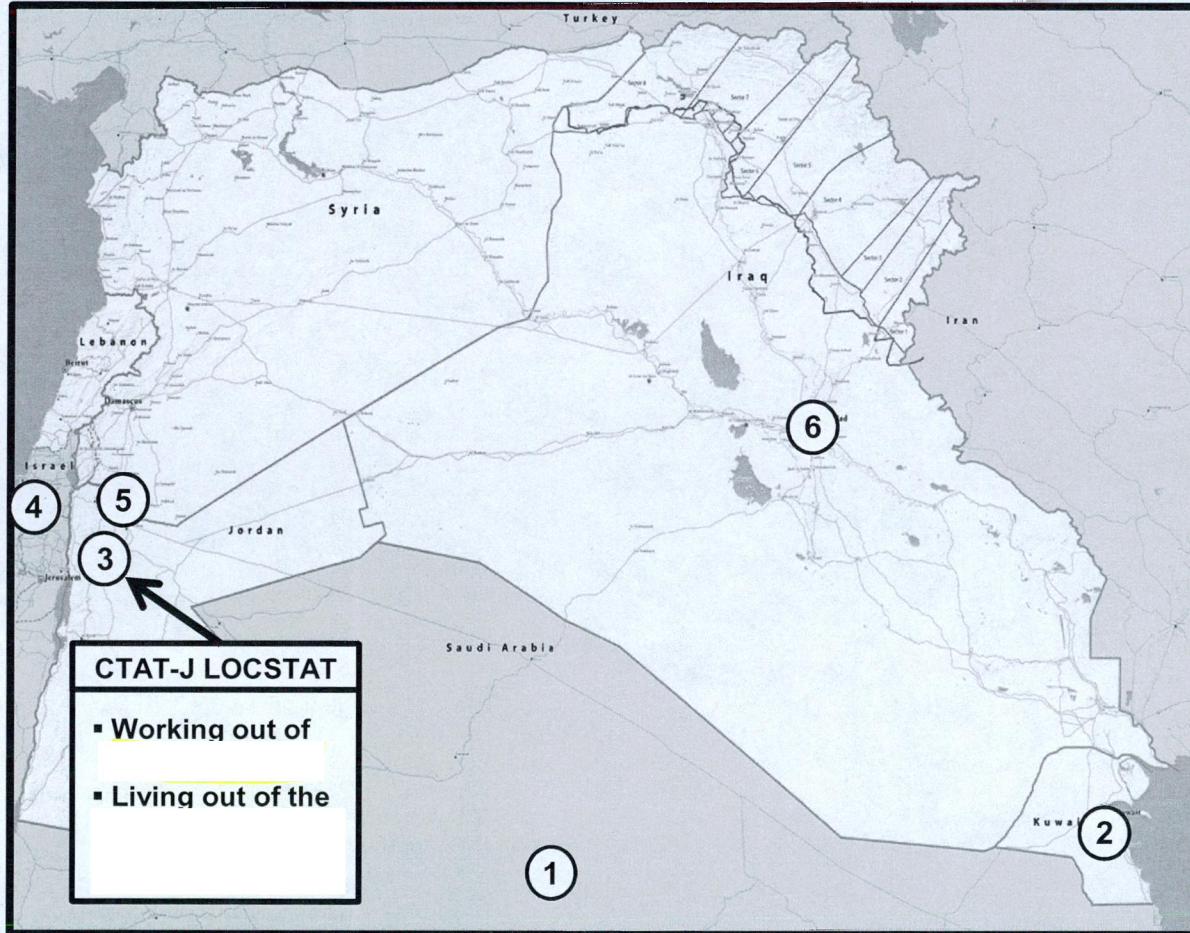

15-1

17

SER	ORG	REMARKS
①	CJOC HQ	<ul style="list-style-type: none"> FE Project Management
②	JTF - I	<ul style="list-style-type: none"> C2
③	CDA - J & Embassy (2) (+2 on 1 Sep) (LCol & Maj Foote)	<ul style="list-style-type: none"> Liaison & facilitation with Jordanian Govt & GAC
④	CDA Tel Aviv (1 - LCol) MC Space = 9	<ul style="list-style-type: none"> Regional engagements, oversight & coordination
⑤	CJOC - J LNO (Under Op FOUNDATION) (1 - LCol)	<ul style="list-style-type: none"> Coalition engagements via Build Partner Capacity
⑥	CJTf-OIR CJ7 (1 - BGen Anderson)	<ul style="list-style-type: none"> Coalition Training

CTAT-J PROJECTS	
<ul style="list-style-type: none"> Pri 1 - Border OP Access Route Pri 2 - NVG's/ISR eqpt/trg Pri 3 - Border OP QOL Infra Pri 4 - QRF Wet Weather Gear Pri 5 - JTAC and Log Sp Trg 	

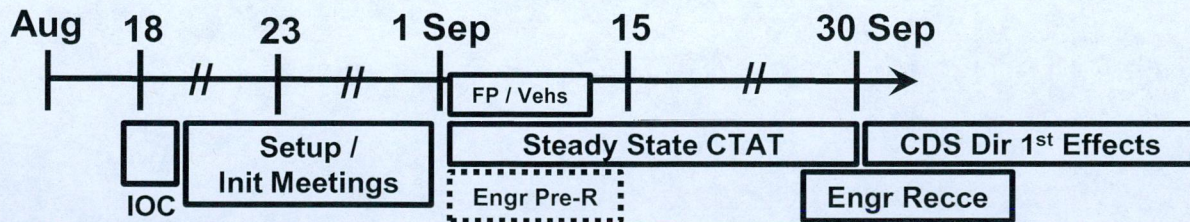

15-1

RECCE OBJECTIVES

- Confirm JAF requirements
- Gather data on the state of the road IOT define the feasibility, scope of work and ROM of costing and work flow.
- Confirm the capacity and capability of JAF Engr and local contractors (aggregate, rental of Heavy Eqpt and construction)
- Establish liaisons (with JAF, potential contractors & provider)
- Investigate [redacted]
- [redacted] stimate for Engr work

15,

Pre-Engr (TAV) Recce Composition (6)

- Maj T.W. [redacted] (Lead, CJOC HQ J Engr)
- 2 x Hor Constr SMEs (CFJOSG 1 ESU)
- 1 x CE Supt SME (CFJOSG 1 ESU)
- 1 x Hy Eqpt SME (CFJOSG 1 ESU)
- 1 x Survey Tech (CFJOSG 1 ESU)

CTAT Support

- [redacted] Coordination
- Movement
- Linguistic / Liaison
- Log O (contracting assessment, reach back J4 contracts)

CONCERNS / ISSUES

- Threats & Hazards [redacted]
- Local contracting capacity & capability

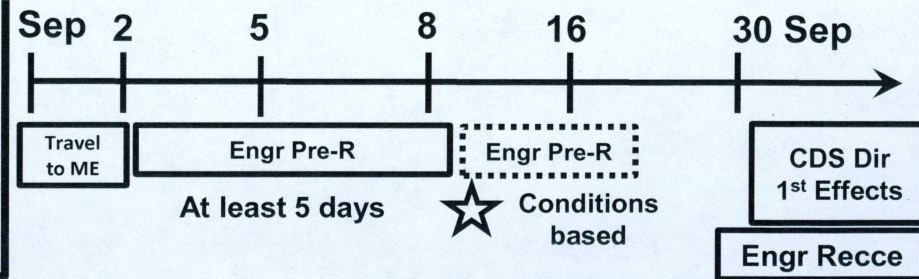

TAC AVN TO&E

Problem Statement (JFACC / 1 Wing) - Sustain a combat capable Tac Avn Det in support of Op IMPACT, be postured to sustain second deployed location (Africa TBC), while minimizing impact to its FP&R and YFR allocation

MACRO RCAF MRP

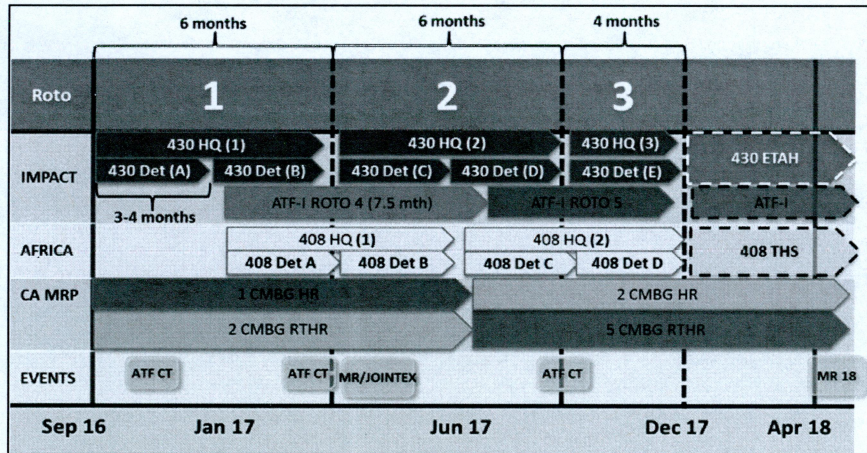

MICRO RCAF OP IMPACT OPTION

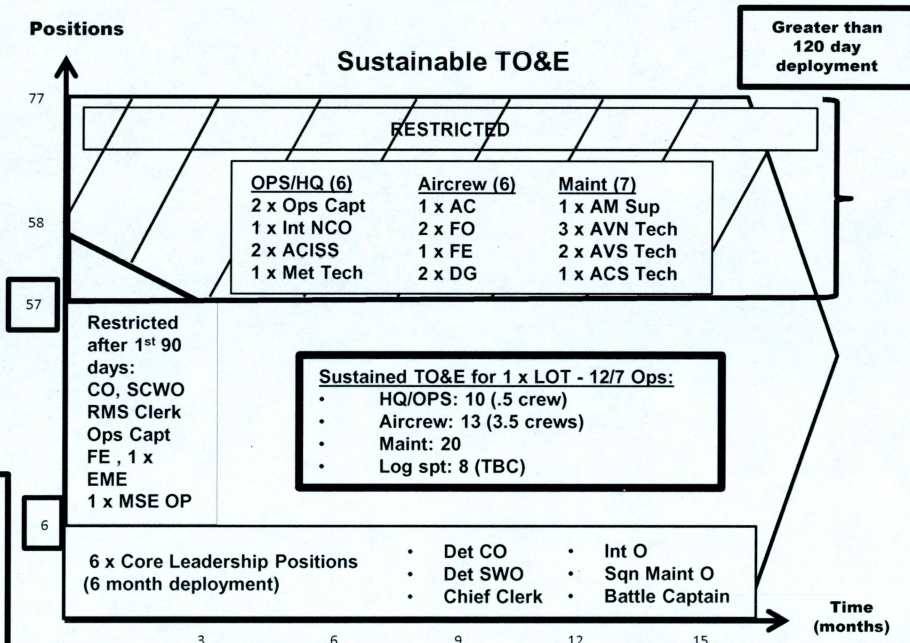

ATF FG: Shifting to 7/8 months for ATF/Fleet Alignment

RECOMMENDATIONS

- Approve the TO&E reduction (77 to 57) by Comd 1 CAD
- Restrict the new empty TO&E positions (Increased flexibility)
- Support the 90 day deployment cycle for the Tac Avn Det
 - RCAF have to sustain FG of a Tac Avn Det until Dec 17
- Reassess if operational tempo significantly increases for prolonged period of time

Background

- Initial CONOPs - daily flying

Current Ops Tempo

- Average mission duration - (longest)
- Weekly flying rate of

- Mission: Troop/VIP transport (primary)
 - Deliberate Ops: Secondary for casevac standby and

Assumptions

- 12/7 Flying Ops: 1x 8 hr LOT (2x CH146)
- Tac Avn Det [core] leadership will deploy for 6 - 8 months
- 1 Wing will fill ATF HQ A5/OSE and Los
- Enable sustainment until 31 Dec 17

Manning

- Unit establishment can only FG / Sustain 2 x Rotos with a 77 pers TO&E (reconstitution period)
- Short rotos (90 days) permit same pers to redeploy for a 2nd 90 day roto within 12 months

Advantages

- Indefinitely sustainable (incl simultaneous deployments)
- Reduced risk to execute YFR allocation (unit flexibility)
- Reduces DAG RED risk / Reduces Repat Risk
- Optimized TO&E/reduced requirements for augmentation (no HLTAs)

CC-150(T) SWAP - SEP 2016 - Op IMPACT

Current Status	CC150-005	Currently @ Op IMPACT, Leaving 9 Sep 16	All options to extend stay in theatre have been exercised, Tanker must depart on 9 Sep to enter maintenance on 12 Sep 2016
	CC150-004	Scheduled to arrive in theatre 9 Sep 16	Currently in maintenance in Mirabel, should arrive in theatre on 9 Sep 2016

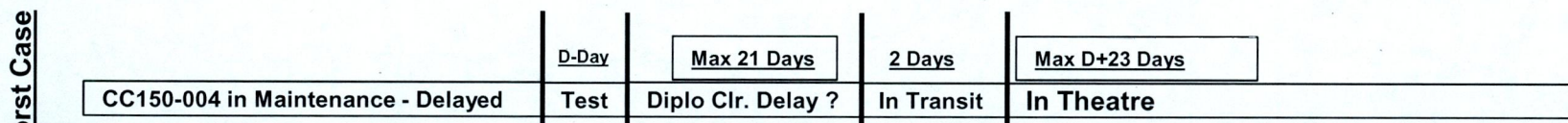
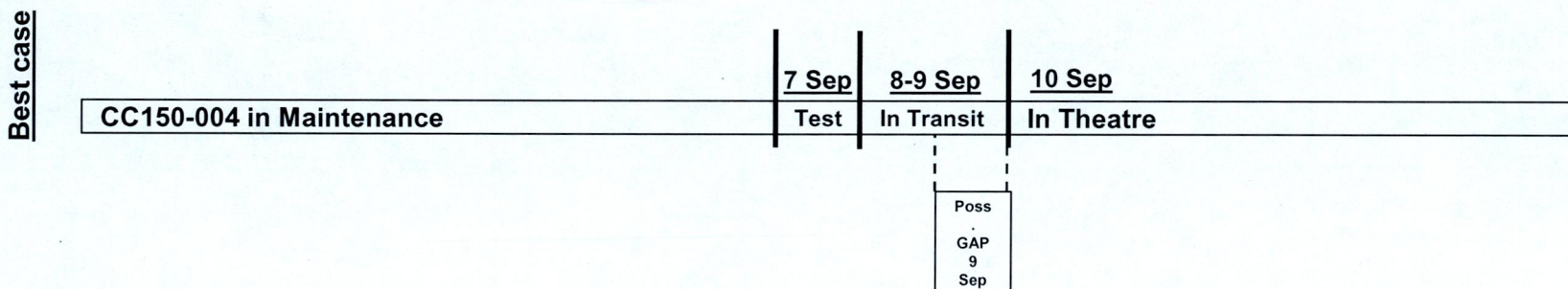
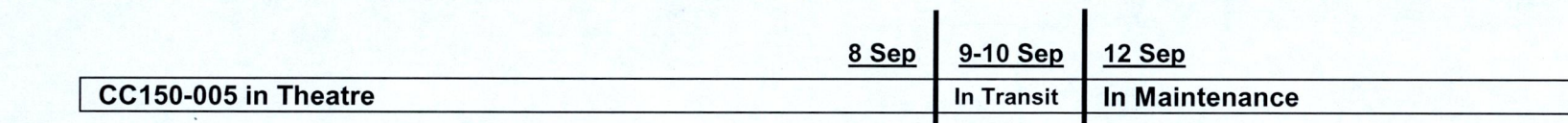

NOTE

- Possible Starting on 9 Sep
- **Best Case** – Maintenance completed as planned - Only a few hours depending on handover time required in theatre
- **Worst Case** – 23 Days no Tanker if all
- Next Diplo Window after 9 Sep scheduled for 05 Sep / 13 Sep / 21 Sep

OP IMPACT – ARIFJAN BENEFITS

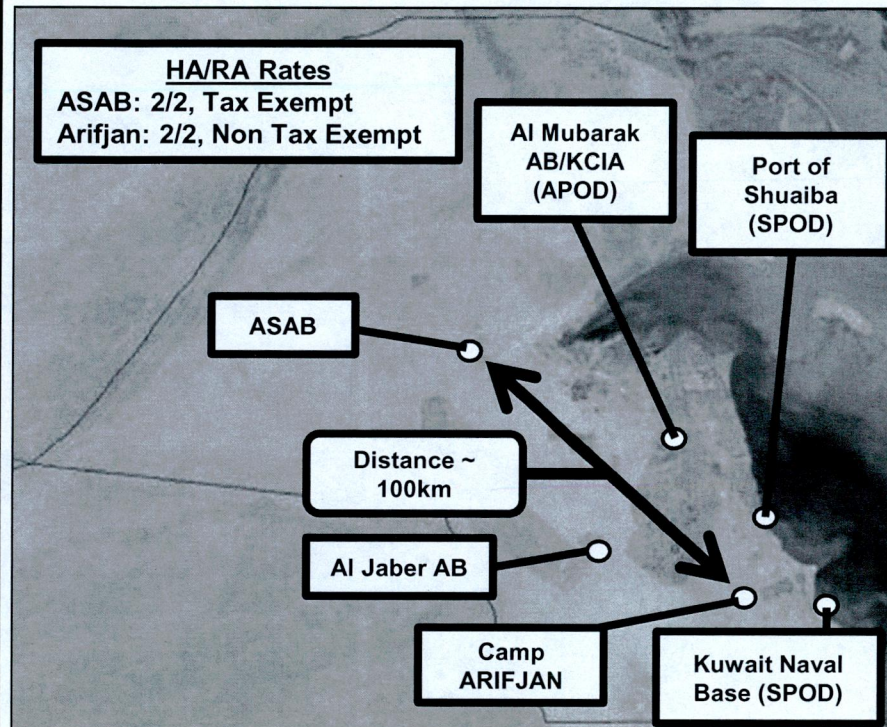

RECOMMENDATION

- Contact Chair of DHRC to request out of cycle review (end of Sep 16) of ARIFJAN
- Provide justification for the change of conditions
- Risk: Scores could go down
- Members will still lose their tax exemption 1 Sep 16
- If Raw Risk Score is between 2.00 – 2.49, tax relief is designated by the Minister of Finance (back dated once approved, but there will be a delay)

PROBLEM FRAME

- Background
 - ASAB, AJAB, ARIFJAN (ROTO 2) all reviewed Spring 2016
 - AJAB, ARIFJAN lost Tax Exemp (Risk Raw score < 2)
 - ASAB kept Tax Exemp (Risk Raw score = 2.00)
- Current Status
 - ARIFJAN will lose Tax Exemption 1 Sep 16 (six month grace was granted)
 - ARIFJAN review cycle – Mar 17
 - Op IMPACT (Baghdad) is being reviewed Sep 16, Comd JTF-I also submitted ARIFJAN for an out of cycle review (received at J1)
 - New submission for ARIFJAN is more detailed and includes more pictures (includes several points that were left off the last review)
- DHRC Committee Overview
 - DHRC will not review missions out of cycle based on TFC's not liking the score
 - For consideration out of cycle, CJOC needs to approach Chair of DHRC if there has been a material change in conditions and provide justifications
- RFIs from theatre (Deputy Chief of Staff CJTF-OIR)
 - CAF members can not move to ASAB, all Staff Officers (SO) are part of HQ CJTF-OIR (US)
 - All members are in a specific position within the HQ

ERBIL CAMP BUILD

SITREP

- ATF JOC bldg IOC delayed 72hrs due to contractor issues
- Confirming impacts of VISA delays on Tac Avn and R2B IOC/FOC

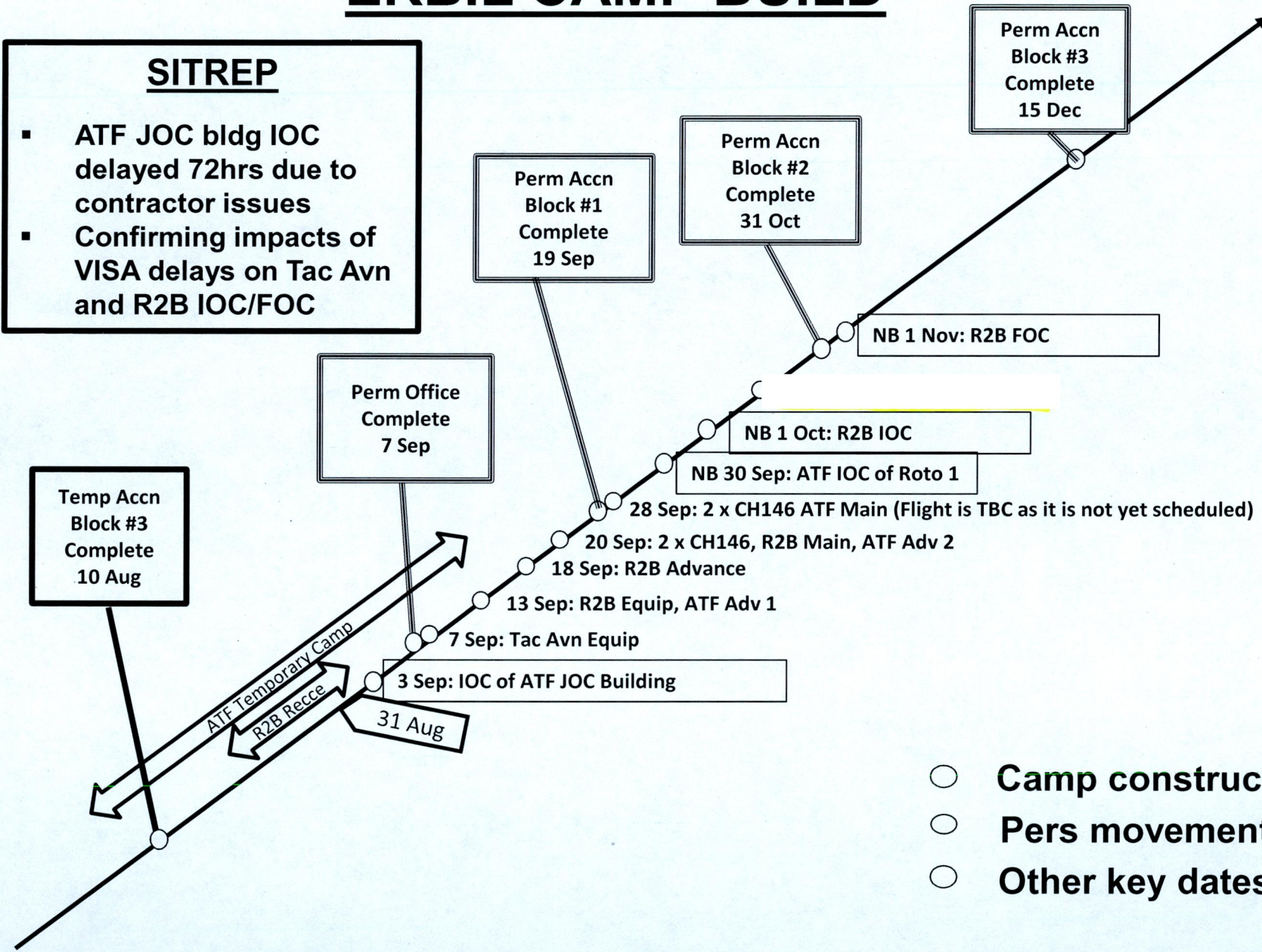

- Camp construction
- Pers movement
- Other key dates

MLT UPDATE

Provisional ECM Timeline

NOTE:

Acquisition = ADM(Mat)/PSPC Lead - FMS, timeline TBC
 Integration = CA/US DoS lead,
 Testing = CA/ADM(S&T) Lead,
 Installation = DoS Lead, in theatre

SITREP

- No change

15-1

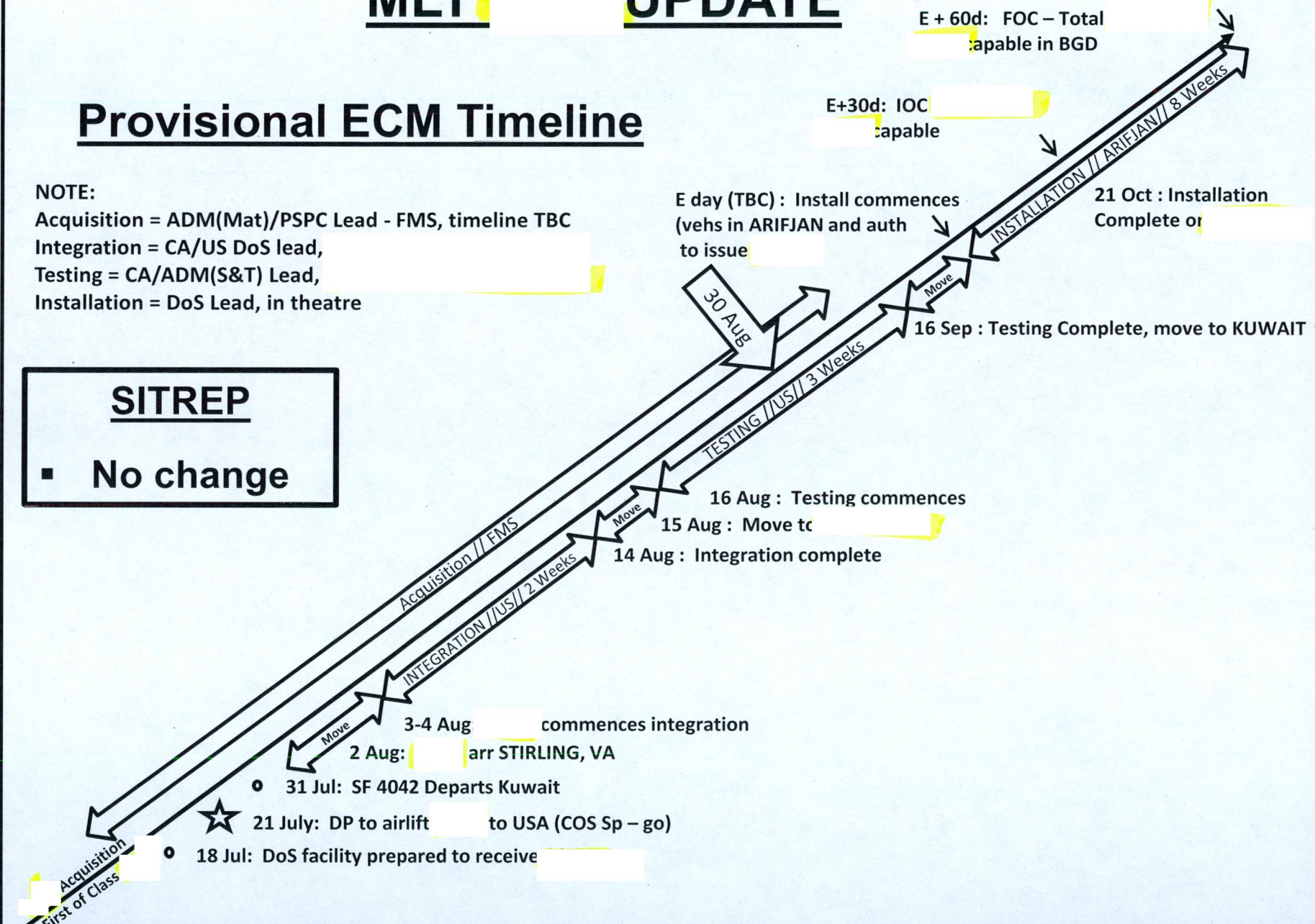

13-1

MLT PLACEMAT – CONOP DELEGATION

DELEGATION CRITERIA

AVAILABILITY: The [redacted] must be available and postured to support all MLT road moves. **TCCC PERSONNEL:** At a minimum, there must be [redacted]

every MLT road move. [redacted]: At a minimum, there must be a tested & workable [redacted] means of communication. This applies to the following:

RESIDUAL RISK: If the Residual Risk of any scenario is assessed as [redacted] the delegation of authority to [redacted]

MLT DIR MACRO ASSESSMENT

Atmospherics
The security situation in Baghdad continues to be stable with the persistent armed presence by Iraqi Security Forces. There have been absolutely **NO (0)** situations or events that any member of the MLT has felt threatened. I firmly believe that the most likely threat to low-profile personal movements in BAGHDAD remains a "wrong place, wrong time" scenario. **Notably, the Italian and French protection details also transit through Baghdad regularly without ECM and without incident.**

Pattern of Life
Iraqi pattern of life has been consistent since arrival in Baghdad. Citizens continue on with their daily affairs with the knowledge of the overt security presence and the elevated vigilance of the Iraqi Security Forces throughout Baghdad.

Trends
Procedures and movement continue to be strictly controlled through the use of permanent checkpoints of which vehicles require the appropriate documentation to transit through. This has remained constant.

MEDICAL

- Medical Assets / Resources
 - Integral (TCCC for CP)
 - Facilities
 - Role 1 at UIII
 - Role 2 at BDSC
- C2
 - Reporting Chains
 - CP Tm, MLT CP, CJTF-OIR, RSO (JTF-I notified immediately)

COMMS PLAN

- [redacted] CP at UIII during movt. Comms is maintained with [redacted]
- P – Radio comms within convoy – Motorola
- A – Iridium Sat Phones
- C – Local Cell Phone Secure App (What's App)
- E – Blackberry

15-1

13-1

(S)

s.15(1)

Canadian Joint Operations Command

SECRET/



Commander's Weekly Update

OP IMPACT

7 September 2016

(150)

AGENDA

- Personnel & Capability Update (J3 ME)
- CTAT Update (J3 ME)
- CTAT-J Reinforcement Update (J3 ME)
- CTAT-J Road Engr Pre-Recce Update (JEngr)
- RCAF FG: ATF Tour Length (J3)
- Erbil Camp Build Update (COS Sp Ops)
- MLT/ Update (COS Sp Ops)
- Comd's Direction

5211

PERSONNEL AND CAPABILITY IN-FLOW

	1 Jun	1 Jul	1 Aug	1 Sep	1 Oct	1 Nov	1 Dec		
JTF-I/HQ 53/1									
FHT 9					11 (+2 Tm Mbrs)				
MH 2 IOC FOC									
JTFSC 105/6									
ATF-I 142/11				150/11 (+8 ATF-I HQ)					
JTF-I Det Erbil				31 (HQ/JTFSC)	8 (Tac Avn): 07 Sep 46 (+38): 21 Sep 57 (+11): 02 Oct 77 (+20): 28 Sep	48 (R2B:42 med + 6 sp)			
ASIC 43/1				FOC					
Embeds 15			30 (new embeds)		2 (CSEC & ITAC)				
MLT _{IOC} 5	8 (MLT Adv + FP)	14 (Med, FP, Linguist, Clk) Int'l Zone Move	20 (Int O, CP)	IOC 22	26				
CTAT		(13) LoE4 Recce 8-19 July	5 (CTAT-J)	7	9		9 (CTAT-L)		
TF-66	(Tac Avn Det)								
	01 Jun 506	18 Jun 537	03 Jul 543	28 Jul 558	18 Aug 569	01 Sep 616	15 Sep 626	01 Oct 706	Nov 808
	5 Jun 509				11 Aug 564				

15-1

- RECENT MILESTONES**
- Capability
 - Theatre Opening Team (On-Going)
 - CTAT-J Engr Pre-Recce
 - LCMR
 - Authorities
 - Planning / movements
 - CTAT-J – JEngr Recce

- CIVILIANS IN JOA**
- Total =
 - HQ =
 - ATF-I =
 - JTFSC =
 - ASIC =

- UPCOMING ACTIVITIES**
- Capability
 - MLT Vehicle /
 - FHT increase
 - CTAT Lebanon
 - JTF-I Det Erbil
 - R2B Erbil
 - Planning
 - TO&E Change #10