

Summary of Amit Patel's Embezzlement of Jacksonville Jaguars Funds

Time Period: September 2019 - February 2023

Name	Amount (\$)
FanDuel	\$ 20,079,874.07
DraftKings	1,188,650.64
Apple	580,628.53
Newegg	297,084.11
Amazon	31,490.94
Palm Tree Music Festival	22,240.18
Best Buy	10,485.93
Fantasy Sports	1,000.00
Grand Total	\$ 22,211,454.40

Overview of Amit Patel's Embezzlement of Jacksonville Jaguars Funds Time Frame: January 2021 - March 2023

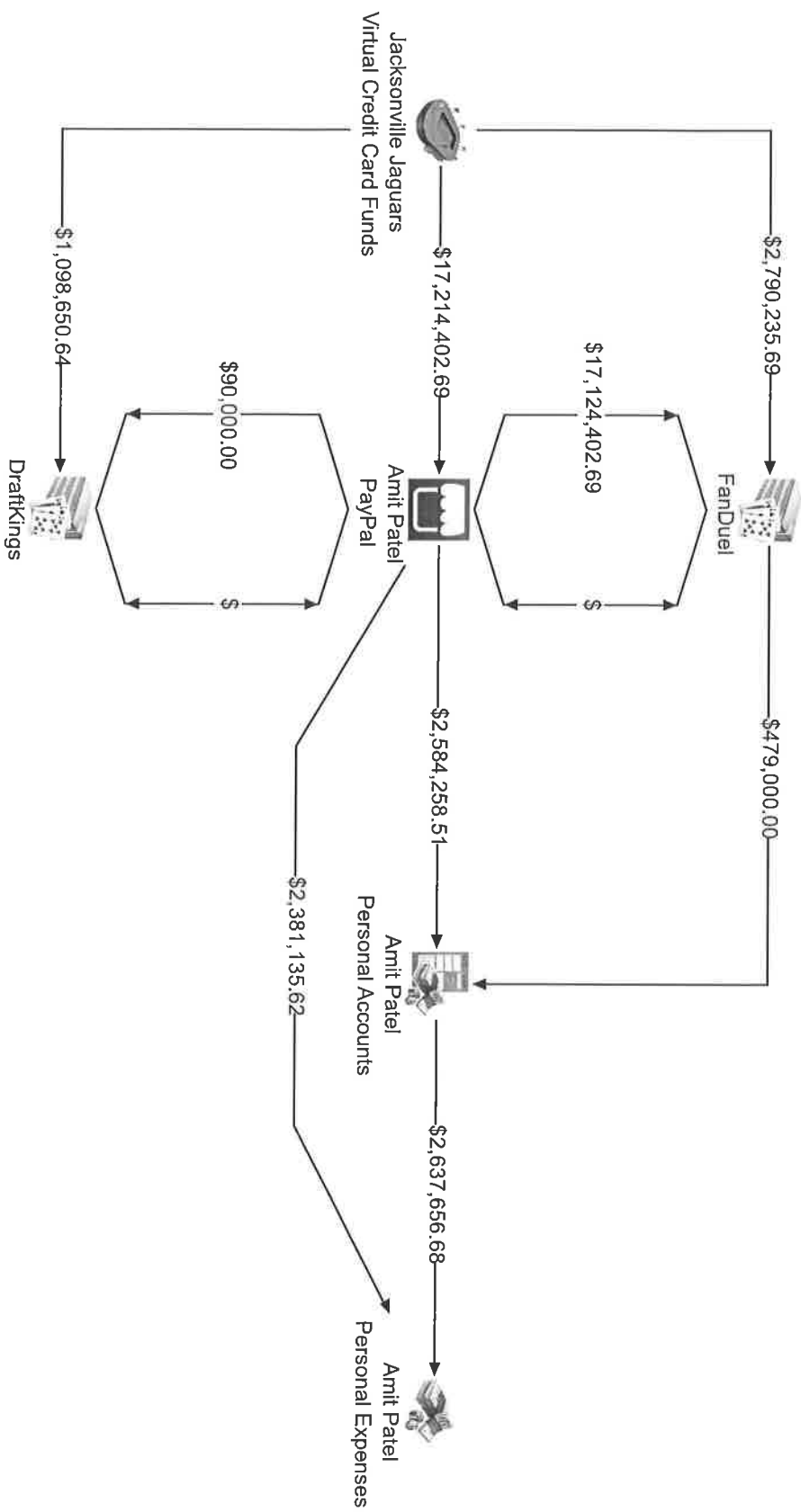

Exhibit 2

Amit Patel's Personal Expenditures Using Jacksonville Jaguars Embezzlement Proceeds

Time Frame: January 2021 - March 2023

Name by Category	Amount
Financial / Cryptocurrency	\$ 2,148,262.61
Regions Bank Credit Card Payment	1,089,000.00
Coinbase	717,461.94
Debit Card Transfers	99,637.72
ATM / Cash Withdrawal	87,763.78
CashApp Transactions	60,538.52
American Express	39,597.44
Apple Cash	37,901.75
PayPal Transactions	4,185.76
FTX	4,120.10
Withdrawal Fees	2,672.92
Credit Card Fees	1,971.21
Scotiabank	1,252.89
MoonPay	800.18
PayPal Crypto Hub	409.96
Fidelity Brokerage	392.86
Bank Fees	301.90
CoinTracker	199.00
E-File.com	29.99
Bitski Crypto	24.69
Individuals	1,063,067.16
Shopping	569,963.96
The Golf Auction, LLC	201,481.16
eBay	140,412.97
The RealReal, Inc	95,484.15
Golden Age Auctions LLC	43,687.60
Apple Inc	23,535.50
Amazon	8,705.27
Lenovo Corporation	4,870.34
Wayfair	4,306.66
DICK'S Sporting Goods	4,167.55
SPD Group Inc	2,748.51
Instacart	2,720.98
Harrods Ltd	2,452.66
Bettinardi Golf	2,150.00
Publix	1,775.29
Herman Miller	1,757.63
Dyson Inc	1,522.92
PGA Tour Superstore	1,505.20
Best Buy Co.	1,451.23
Target	1,422.98
Sunglass Hut	1,344.76
Gucci	1,224.75
Article Furniture	1,137.43
Samsung Electronics	1,056.43
Lowe's	943.90
Augusta National Golf Club Merchandise	937.98
Fanatics	937.19
Neiman Marcus	885.00
Cobra Golf	590.18
Acushnet Golf	543.15
Jaguars Pro Shop	500.19
Louis Vuitton	499.88
Callaway Golf	455.25
Nordstrom	441.29
Vineyard Vines	440.22
F1 Store	430.08
Macy's	426.76
Total Wine & More	423.12

Cost Plus World Market	397.42
NicknameThings	393.45
CVS Pharmacy	378.35
Nordstrom Rack	375.93
Petco	350.39
Fresh Direct Wines & Spirits	347.65
Golf Shop	330.15
The Home Depot	310.50
Interactive Life Forms, LLC	307.81
Bad Birdie Performance Golf	298.94
Team Fan Shop	287.95
Golf Galaxy	286.19
Tommy Bahama	277.63
Mosaic Foods	261.76
Sports Card Investor LLC	249.95
Fairmount Supermercado	243.71
Adobe Inc	238.82
Jax Pickleball Store	236.91
Puma Golf	234.30
Scotty Cameron	226.56
Whole Foods	221.21
Microsoft	219.94
Rhoback	216.17
Zola	200.00
HomeGoods	200.00
Cole Haan	196.92
ABC Fine Wine	183.00
J.Crew	180.60
Rhone Apparel Inc	178.92
GoCollect	178.00
Casper Sleep	152.41
ClickBank	150.00
New Balance	138.44
Solano Cycle	128.87
Ann Taylor Factory	123.56
ASAI Fashion	115.50
Smoke City	106.95
Lululemon	105.35
Duck Head	104.28
Quay Inc Sunglasses	102.13
Food Service Direct Logistics, LLC	98.90
Brooks Brothers	87.89
Express LLC	86.00
Academy Sports	85.99
Asher Golf	79.99
GameStop	75.24
Dillard's	74.71
Ikea	70.92
The Connect Las Vegas	70.44
Golf Discount	64.23
Vivid Images USA Inc	60.48
Ponte Vedra Liquors	55.34
Winn-Dixie	53.74
LFAVRE	53.50
Southern Tide	51.06
Walgreens	45.96
Kohl's	43.33
Vinci Brands LLC	37.26
Broudy's Liquors	33.64
S L Food Mart Inc	21.48
Bed Bath & Beyond	17.20
Honeyfund Gift	15.98
Rapid 24 Hrs Supermarket	15.40

Smokers Depot	13.50
FedEx	12.25
UPS	7.99
Pinspiration	6.50
MySoda	4.99
US Connect Vend	3.45
Google Storage	2.48
Dollar Tree	1.34
Entertainment / Recreation	301,105.55
Gate Hospitality	77,866.83
Ticketmaster LLC	69,025.26
StubHub	63,345.98
Vladdy Daddy Show	35,150.00
Beach Club Encore	9,372.85
Jacksonville Jaguars	7,860.91
TPC Sawgrass	5,895.61
Chinawhite Nightclub	2,911.74
Palm Tree Music Festival	2,776.24
Savor Arena	2,539.90
Top Golf	1,837.76
Zouk Nightclub Las Vegas	1,832.61
Hulu	1,780.19
Inca London	1,316.06
Epoch	1,087.02
On Location Experience	1,000.00
Mosaic Ultra Lounge Night Club	942.70
YouTube TV	847.10
Tournament Players Club	840.08
King & Bear Golf Course	812.01
Everbank Field	625.54
Oak Bridge Club	585.78
SeatGeek Event Tickets	579.71
Golf Club of Amelia Island	576.70
UNF Athletics	560.00
TIAA Stadium Club	490.67
Scores Las Vegas	480.00
Breakers Sports Pro Shop	476.15
DataGolf	435.00
GolfNow	431.88
Maple Hill Golf Course	415.71
The Players Championship	410.73
Slammer & Squire Golf Course	364.27
Timuquana Country Club	360.04
Dave & Buster's	328.95
ATP Media	299.80
UFC Fight Pass	277.42
MLB.TV	259.98
The Yards	243.89
Spotify USA	226.60
Atlantic Beach Country Club	220.38
Windsor Parke Golf Club	213.32
Glen Kernan Golf	196.47
The Golf Club at South Hampton	193.39
Netflix	173.36
Puttshack - Miami	163.46
Google Disney Mobile	161.14
Florida Theatre	161.10
The Honda Classic	137.00
NBA League Pass	129.99
Moose Lodge	125.45
London Eye	124.51
Jacksonville Jumbo Shrimp	116.00
Facility Concession Palm Beach	114.77

Julington Creek Golf Club	107.07
Magnolia Point Golf Club	105.78
Fanmio	99.98
Shingle Creek Golf Club	95.26
TouchTunes	80.00
Aramark MGM Grand	78.00
Hampton Court Palace Tour	68.64
Florence Nightingale Museum	57.12
Hippodrome Casino	54.01
Marsh Landing Golf	53.25
Showtime Digital	52.52
Amalie Arena	51.50
The Secret Garden Las Vegas	50.00
Hard Rock Stadium	49.00
Amway Arena	45.82
Forescore Golf	42.89
NBC Gold PGA Tour Live	39.96
SMG Jacksonville	35.00
Moment House	31.18
Oak Marsh at Omni Amelia Island Resort	29.97
GenMedia	29.95
UNF Golf Learning	28.77
Masters Concessions	28.00
Anchor Amusement Co	26.40
Autobahn Indoor Speedway	20.00
Trowel & Trellis Epcot	20.00
Prime Video	9.50
Wembley Stadium Concessions	8.47
CTM Group Inc	4.00
GolfBack LLC	2.50
Gannett Newspaper	1.00
Travel	278,989.96
FBO Jets	78,800.00
Hotels.com	39,546.11
Delta Air Lines	29,792.11
Vrbo	17,515.83
United Airlines	17,021.41
American Airlines	16,217.50
The Surf Lodge Hotel	11,001.23
Wynn Las Vegas Hotel	9,348.21
Cosmopolitan Las Vegas	8,259.98
Seminole Hard Rock Hotel	6,606.95
Southwest Airlines	4,751.96
Vacations to Go	4,131.27
Sea Island Lodge	4,094.52
Chase Travel Trip Charge	2,796.98
Uber	2,647.00
JetBlue Airways	2,579.08
Ameristar Kansas City	2,499.48
Mission Inn Resort & Club	2,260.96
1 Hotel South	2,045.48
Bellagio Las Vegas	1,975.66
The Breakers Hotel	1,740.62
Cocal Hotel and Casino Costa Rica	1,500.00
Leader Worldwide Chauffeured Services	1,365.00
Four Seasons Beverly Wilshire	1,174.25
Mega Light Brasil	1,096.86
PV Hotel	993.97
Ritz Carlton Amelia Island	983.22
Los Suenos Costa Rica Marriott	915.79
Grand Hyatt Tampa	779.89
Bally's Las Vegas	764.00
Price 4 Limo Service	701.00

Jacksonville Aviation Authority	622.55
Landmark London Hotel	446.67
Jacksonville International	405.50
Lyft	269.15
MGM Grand Las Vegas	233.64
Rickshaw	220.50
AC Hotels by Marriott	196.88
Westin Charlotte	127.37
GoGo Air WiFi	123.80
Minisuper El Ruby	67.89
Ecommerce Sagicor Costa Rica	56.00
Wheels Ride In Style	54.02
Bird Rides Inc	50.00
Wifi OnBoard	47.21
Viasat In-Flight Wifi	36.00
Britt Shop MM Aeropuerto	26.78
Seminole Exchange LLC	25.00
Sunpass Operations	22.97
T-Mobile Hotspot	19.02
Intelsat Inflight LLC	15.99
Maud In-Flight	12.00
Central Florida Expressway	4.70
Legal Fees	275,000.00
Monroe & King PA	275,000.00
Home / Car	234,003.66
Gasdick Stanton Early PA	123,000.00
Tesla Inc	50,478.84
Coggin Nissan at the Avenues	32,500.00
St Johns County	4,625.97
Interiors Revitalized	3,626.33
Allstate Ins Co Premium	2,914.00
Chimney Champions	2,899.00
The Elite Experience	2,487.72
St Augustine Wrap	2,400.75
Comcast	2,327.97
Advanced Window Tinting	1,204.00
LunsPro Inspections	934.00
Beaches Energy	718.83
Marsh Cove Condo HoA	620.00
All About Blinds	598.00
Wawa	577.57
St Johns County Utility	539.54
Security First Insurance	296.34
Buehler Air Conditioning	282.00
ecobee SmartThermostat	266.24
Shell Oil	136.16
Duval County Clerk	132.55
St. Johns Board of County Commissioners	115.99
Duval Vehicle Department	79.05
My DMV Portal	77.00
Luv Car Wash	44.00
RaceTrac	41.13
Gate	37.66
Scrubbles Car	25.00
Circle K	13.96
BP	2.14
Chargepoint	1.92
Gambling / Sports Betting	95,984.52
Bestbet	33,916.02
Underdog Sports Inc	29,834.75
Bravo Poker Live	10,298.00
SuperDraft Fantasy Sports	5,000.00
MonkeyKnife Fight	5,000.00











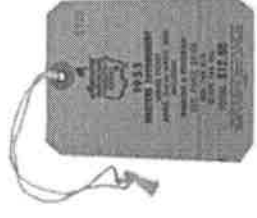
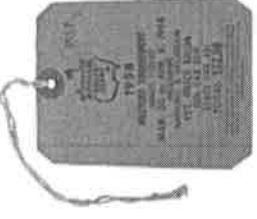

Performance Predictions LLC	3,500.00
Poka Nigeria Limited	1,665.90
Awesemo.com	1,539.45
RotoGrinders	1,319.89
Sleeper Software	1,000.00
DailyFanMMA	895.64
Everi	818.98
SaberSim Fantasy	425.95
Better Collective Tennessee LLC	399.99
Cutsweats Analytics	220.00
Occupy Fantasy	100.00
FantasyCruncher	49.95
Restaurants / Bars	25,206.27
Uber Eats	3,320.05
Main Squeeze Juice Co	1,174.93
JaxSpice	1,002.08
Anejo Cocina Mexicana Restaurant	930.31
Louie Bossis Ristorante	774.74
Mezza Luna Ristorante	764.64
Buffet Prepaid	732.47
Hawkers Asian Street Food	641.78
Tijuana Flats	597.44
Taco Bell	585.93
V Pizza	575.68
Chuy's	533.36
Grape & Grain Exchange	439.03
Sierra Grille	424.19
Taqueria Mexico	421.48
The Refinery Restaurant	400.00
Benihana	400.00
Circle Dining Room	398.04
Restoration Hardware Restaurant	378.05
Kaiba Japanese Steak House	353.59
HMS Host	352.18
The Loyalist	347.00
Mellow Mushroom	328.75
Dishoom Carnaby Indian Restaurant	291.83
McDonalds	285.96
Taverna	277.50
Olive Garden	276.20
Foxtail Coffee	274.31
Subway	268.05
Caffe Andiamo Restaurant	239.36
Baires Grill	229.71
Jimmy Johns	203.28
Waffle House	202.82
Brix Taphouse	198.70
Chick-Fil-A	180.88
Ritz Lounge Bar	171.41
Hovan Mediterranean Gourmet	168.85
Valley Smoke Restaurant	168.32
Bombay Bustle Indian Restaurant	168.23
Biggie's Pizza	162.36
O-Ku Restaurant	157.50
Panera Bread	154.90
Sushi House	151.52
Papa John's	146.56
Bonos Pit Bar-B-Q	143.47
The District SPR	135.00
Newk's Eatery	119.29
Yard House	115.21
Hoptinger	114.66
Main Event	112.03

Quick Pick	110.68
Otaki Japanese Steakhouse	110.63
Surfer the Bar	106.89
Another Broken Egg	106.88
Southern Grounds	104.17
Casa Reina	103.86
Chipotle	103.67
The Tavern	99.40
Drive Coffee, Inc.	99.00
Briciole Italian London	96.29
Crabtree Pub & Restaurant	93.41
Intuition Ale Works	93.26
Burgerfi	92.67
Monkey's Uncle Tavern	88.13
Nashville Underground Restaurant	87.30
Restaurante Bar Black	83.62
Wasabi Japanese Steak	83.16
Bold Bean	81.25
Landshark Bar Grill	77.67
3 Palms Grille	77.51
Banq Catering St Simons Island	77.24
Tonino's Trattoria	75.00
Ink Factory Brewing	70.79
Famous Toastery	70.00
Daruma Japanese	65.71
PF Chang's	61.65
Bento Asian Kitchen	60.20
The Drugstore Café Las Vegas	56.30
Cantina Louie	55.09
La Nopalera Mexican Restaurant	52.39
DragonFly Sushi	50.02
Fancy Sushi Jax	49.17
Kaika Teppanyaki Asian Fusion	48.96
Firehouse Subs	47.87
The French Pantry	47.50
Sugar Bar	47.46
Casa Maria	47.40
Hyde Lounge at Crypto.com Arena	44.00
Pusser's	43.77
Wicked Barley Brewing	42.26
Renna's Pizza	40.75
Marylebone Bar & Grill London	40.56
Palm Valley American Legion	40.52
Engine 15 Brewing	37.96
9 Zero Pour LLC	36.86
Zoe's Kitchen	36.33
Brewer's Pizza	34.18
In N Out Burger	32.14
Mayes Food Service	32.00
Que Onda Tacos & Tequila	31.82
Pete's Bar	30.30
Senor Loco Tacos & Tequila	30.12
DiFara Pizza at Caesars Palace	29.23
Superica	27.32
Auntie Anne's	26.45
Tropical News	25.34
Moe's	24.79
The Mini Bar	23.65
Wreck Tiki Bar	23.14
Currito Burrito	21.51
Olio Restaurant	21.44
TacoLu	21.26
Apna Bazar	21.08

The Lemon Bar	21.04
The Mirage Las Vegas	20.70
Five Guys	20.49
Cantina Laredo	20.00
Sbarro	19.78
Cultured Collective Brewing Co	19.50
Si Senor Mexican Restaurant	19.33
The Element Indian Cuisine	19.33
Ida Claire	17.99
The Garage	17.37
Iguana on Park	16.90
Starbucks	16.81
The Mitt Tex-Mex Café	15.79
Green Room Brewing	15.00
Hibashi Party	14.78
Panda Express	12.89
Gringos Locos	11.94
Pine Garden Restaurant	11.86
Midtown Table	11.60
Jaco Restaurante Bar	11.59
Coca Cola	11.00
Mitchell's Fish Market	11.00
Chill's	10.86
Mercedes Benz Stadium	10.85
Soho Saloon	10.06
CMS Vend	10.00
Beer Vending	9.60
The Wine Bar	9.50
Wendy's	9.13
Sonic Drive-In	9.02
904 Burgers	8.61
Ez Eats by Yaya	7.74
The Hungry Owl Food Truck	7.38
Better Days Cocktail Bar	7.37
Aardwolf Brewing Company	6.99
The Happy Grilled Cheese	6.72
Round Bird Coffee	6.62
Vending Machine	5.69
Wingin'it	5.00
Yugen Café London	4.60
Ocean Front Food	3.98
Mayport Cats	3.50
Canteen Vending	1.75
Employment & Development	17,927.92
Palm Tree Pool Club LLC	8,567.01
CPA Exam Services	3,322.32
Riptide Pool Vacuums	2,215.20
DFS Inc Flex Plan	1,185.82
Prometric Exam Fee	878.74
Becker CPA	428.08
Grasshopper.com	404.75
BrandCrowd	386.00
Swim University	249.00
Clear Pool Di	145.00
Squarespace	92.00
Skimmer Pool Software	39.00
Primate Pool Tools	15.00
Personal Care	8,089.45
Jacksonville One Ocean Resort and Spa	2,344.27
Med UF Health	1,525.73
F45 Training Jacksonville	1,441.00
Marriott Sawgrass Spa	1,113.32
Keeps	560.00

Beau the Barber	390.25
Elite Nail Spa	315.00
Avecina Medical, PA	125.00
Cool Cats Cave Barbershop & Parlor	100.00
The Cut Inc	78.16
Man Cave	61.27
Beach Cleaners	19.95
Pugh's Dry Cleaners	15.50
Miscellaneous	1,191.24
Grand Total	\$ 5,018,792.30

Payments to The Golf Auction, LLC (\$201,481.16) Using Jacksonville Jaguars Embezzlement Proceeds

							\$36,300.00	\$17,707.00	\$1,854.00	\$4,814.00	\$6,297.00	\$1,685.00	\$1,531.00
							\$10,144.00	\$12,100.00	\$2,988.00	\$18,997.00	\$5,724.00	\$27,815.00	\$7,321.00

*Additional \$46,204.16 of expenses incurred for buyer premiums; insurance; sales tax; and shipping



The Golf Auction - Vintage Golf Memorabilia & Collectibles
 4710 Eisenhower Blvd South
 Suite A-1
 Tampa, FL 33634
 TEL: (866) 842-0268
 sales@thegolfauction.com

Invoice #: 01530260
 Invoice Date: 28 November 2022
 Invoice Due: 12 December 2022
 Tracking #: FEDEX 622093626520
 Ship Date: 21 December 2022

Bill To:

Amit Patel
 [Redacted]
 Jacksonville, FL 32256
 (904) 322-1720
 amyth92@gmail.com

Ship To:

Amit Patel
 [Redacted]
 Jacksonville, FL 32256

2022 November Golf Memorabilia Auction - Closing Date 11/27/2022

	Lot	Description	Final Bid
	4	102035 - Tiger Woods' Personally Gifted Scotty Cameron 1996 US Amateur Newport Victory..	\$36,300.00



The Golf Auction - Vintage Golf Memorabilia & Collectibles
 4710 Eisenhower Blvd South
 Suite A-1
 Tampa, FL 33634
 TEL: (866) 842-0268
 sales@thegolfauction.com

Invoice #: 01530260
 Invoice Date: 28 November 2022
 Invoice Due: 12 December 2022
 Tracking #: FEDEX 622093626520
 Ship Date: 21 December 2022

Thank you for participating in our Golf Memorabilia Auction.

The Golf Auction offers the ability to pay for your invoice right from your user account. You may pay by credit card or by PayPal right from your account. We also offer wire transfer payments using the information below. Please select the Powered By PayPal button to pay by PayPal or Credit Card Checkout button to pay by credit card. The credit card option will allow you to securely store your credit card for future purposes.

PLEASE NOTE: If you have stored a credit card on file, your credit card will be automatically charged within five (5) business days of the end of the auction unless otherwise notified that another payment method will be used for payment of items.

For payment by check or money order please mail payment to:
 The Golf Auction, 4710 Eisenhower Blvd, Suite A-1, Tampa, FL 33634

If there is zero shipping charge on this invoice, please do not pay, shipping is still being updated. An invoice with shipping charges will be available within 24 hours of the end of the auction. There is up to a (5) business day hold on all checks. If you have any questions, please call us at (866) 842-0268 or email us at sales@thegolfauction.com. Shipping of paid items will begin within 3-5 business days of end of auction. Thank you for you bids in our auction and we look forward to seeing you in future auctions. - The Golf Auction

Please visit GolfMemorabilia.com, an extension of The Golf Auction, for a platform of golf collectibles currently up for auction. GolfMemorabilia.com will be open for bidding for 30 days, opening on the first day of the month and closing at 10pm ET on the final day of the month. We're going to do our best to keep these auctions lively and fun for all collectors and fans alike. We have many great items consigned for our upcoming auctions.

Wire Transfer Info:

Wire information
 Domestic Wire Transfer Routing #: [REDACTED]
 International Swift Code (for International wire): WFBIUS6S
 Account # [REDACTED]
 Account Name: The Golf Auction, LLC
 Bank Name: Wells Fargo Bank, NA
 Bank Address: 420 Montgomery Street San Francisco, CA 94104

Lot Total(1 Lot)	\$36,300.00
Buyers Premium	\$7,078.50
Shipping	\$32.03
FL Sales Tax	\$3,253.39
Insurance	\$450.00
Total	\$47,113.92
Paypal 12/21/2022	\$47,113.92
Total Amount Paid	\$47,113.92
Total Due	\$0.00

Transaction details

December 21, 2022 at 6:00:26 AM PST | Transaction ID: 6HN65317T88079924

Payment received from Amit Patel

Gross amount

Payment Status: Completed

Shipping Status: Shipped

\$47,113.92 USD

Ship To Address

Buy Shipping Label

Seller protection

Eligible

Amit Patel

Jacksonville, FL 32256-2359

UNITED STATES

Confirmed

Tracking Information

Add Tracking Info

622093626520

December 25, 2022 at 6:52:49 PM PST

Sent by FEDEX

Manually added

Order details	Quantity	Price	Subtotal
Invoice #01530260 - Auction Lots	1	\$47,113.92 USD	\$47,113.92 USD
		Purchase Total	\$47,113.92 USD

Payment details	
Purchase Total	\$47,113.92 USD
Sales Tax	\$0.00 USD
Shipping Amount	\$0.00 USD
Handling Amount	\$0.00 USD
Insurance Amount	\$0.00 USD
Gross Amount	\$47,113.92 USD
PayPal Fee	-\$1,644.77 USD
Net Amount	\$45,469.15 USD

Invoice ID 16695

Shipment details Shipped
622093626520
FEDEX

Paid by Amit Patel
The sender of this payment is **Unverified**
ap11g@my.fsu.edu

Payment Sent to aaron@thegolfaction.com

Need help?

Go to the Resolution Center for help with this transaction, to settle a dispute or to open a claim.

Payment to The RealReal, Inc for the Purchase of a Patek Philippe Watch Using Jacksonville Jaguars Embezzlement Proceeds

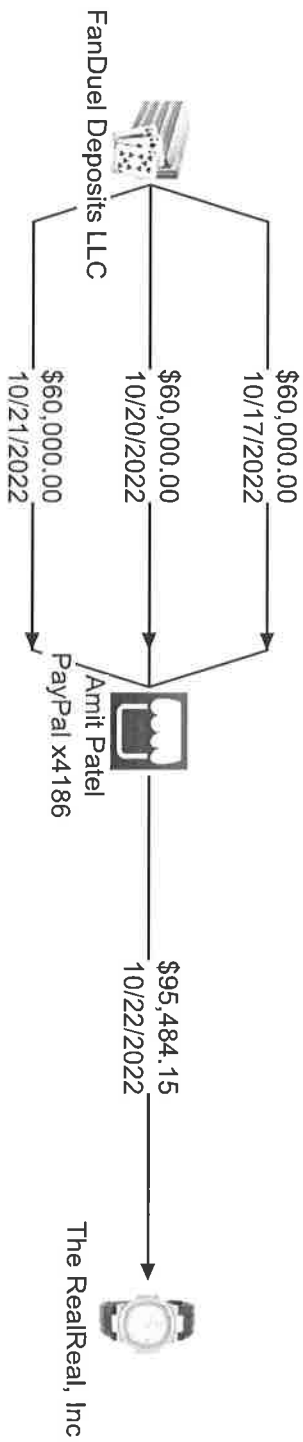

Note: Amit Patel's FanDuel account was analyzed using the lowest intermediate balance rule; based on the analysis performed, the FanDuel deposits into Amit Patel's PayPal account were proceeds of embezzled funds.

Payments to Gasdick Stanton Early PA for the Purchase of a Ponte Vedra Beach Condo Using Jacksonville Jaguars Embezzlement Proceeds

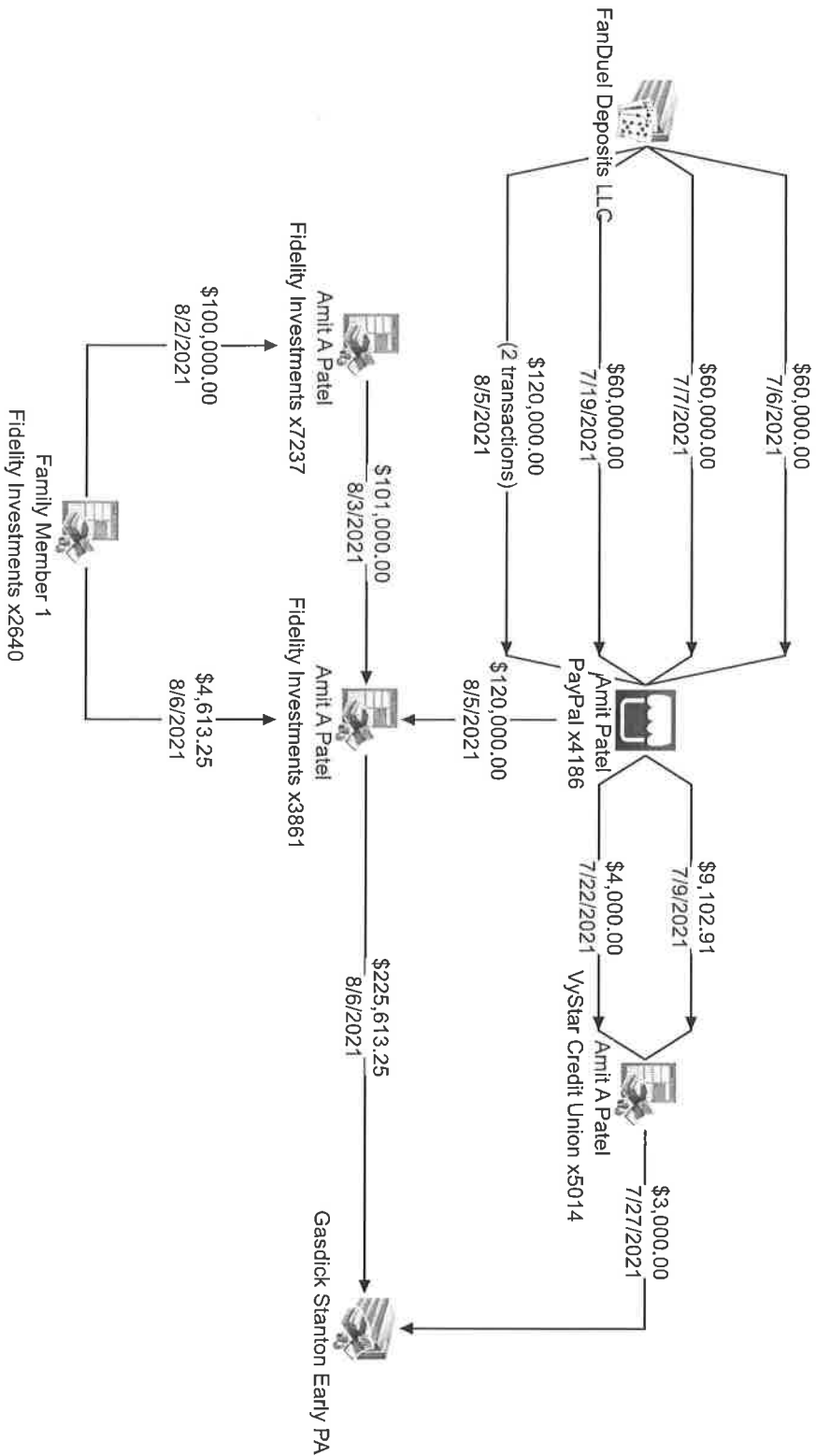

Note: Amit Patel's FanDuel account was analyzed using the lowest intermediate balance rule; based on the analysis performed, the FanDuel deposits into Amit Patel's PayPal account were proceeds of embezzled funds.

Payment to Tesla Motors for the Purchase of a 2021 Model 3 Sedan Using Jacksonville Jaguars Embezzlement Proceeds

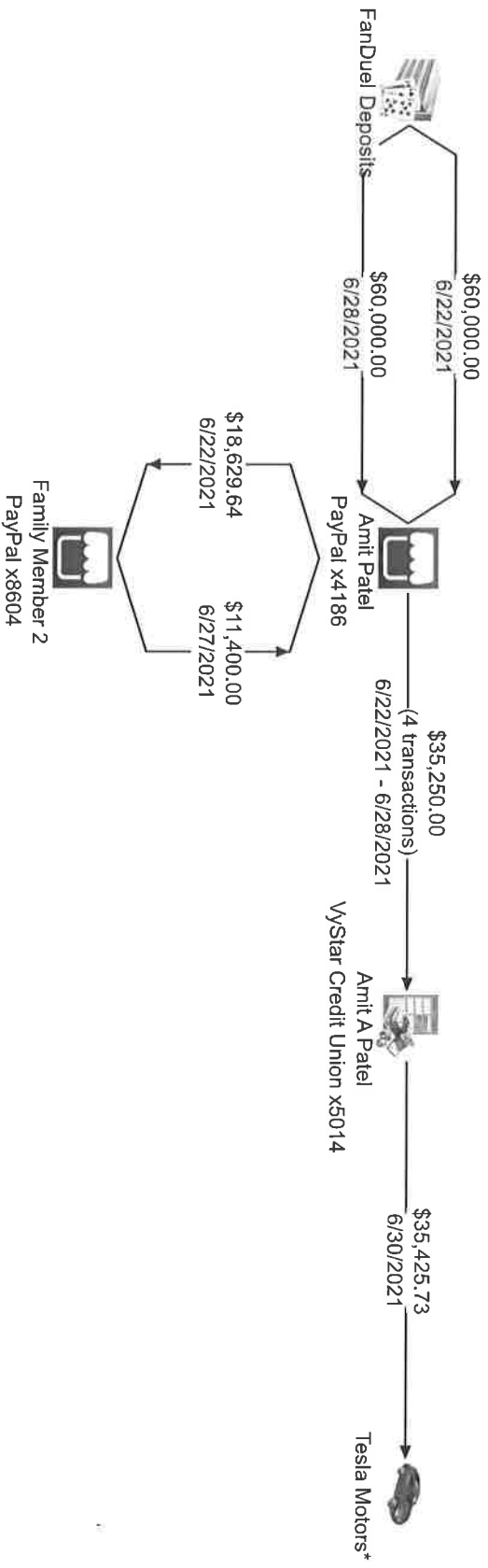

Notes:

- 1) Amit Patel's FanDuel account was analyzed using the lowest intermediate balance rule; based on the analysis performed, the FanDuel deposits into Amit Patel's PayPal account were proceeds of embezzled funds.
- 2) The total purchase price of the Tesla was \$61,625.73. As part of the purchase, Amit Patel traded in a 2018 Tesla for \$26,100.00.



Item: 235330830305



Trevor Lawrence Jacksonville JAGUARS "GAME ISSUED" Jersey

legendssportsart (116)

Item Condition	--
Sale Date	Dec 08, 2023
Quantity	1
Price	US \$2,200.00

[See order details](#)



eBay Money Back Guarantee

Get the item you ordered or your money back

Item specifics

League	National Football League (NFL)
Features	Used in Game
Sport	Football
Team	Jacksonville Jaguars

Seller's description

[See full description](#)

Trevor Lawrence Jacksonville JAGUARS "GAME ISSUED" Jersey. Features include 2022 year, 40 size, L-BK cut collar tagging. Correct cuffed sleeves and length. NIKE logos, NFL shield, captains patch, etc.



Trevor Lawrence Jacksonville JAGUARS "GAME ISSUED" Jersey

Return started



See return details

More actions ▾

Order

Order no.	16-10898-38002
Sales record no.	261
Date sold	Dec 8, 2023
Date buyer paid	Dec 8, 2023
Buyer	Amit Patel palmtreappool@up (103) Repeat buyer

Show contact info ▾

Track package

Contact buyer

Shipping

Ship to **Amit Patel**
 Ponte Vedra Beach, FL 32082-1628
 United States

Buyer selected shipping service
 UPS Ground

Tracking
 9410808205498417309266 Edit

Phone
 +1 904-712-0744

Payment

This order is complete and we've made the funds available for payout.
[Learn how you get paid](#)