

**Here's an example, a battalion tactical group, 700 to 900 soldiers and an array of different types of vehicles.**

It is one of many types of formations used by the Russian army, according to retired Lt. Col. Alex Vershinin, whose career with U.S. and NATO forces included building logistical models.

10

**Tanks**

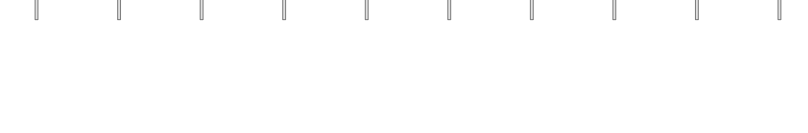

6

**Armored personnel carriers (APCs)**

With mortars mounted on top

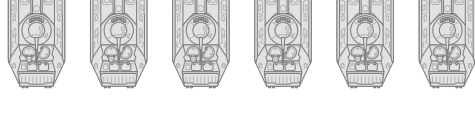

40

**Armored infantry fighting vehicles (IFVs)**

Carry troops into battle and usually have cannons mounted on them

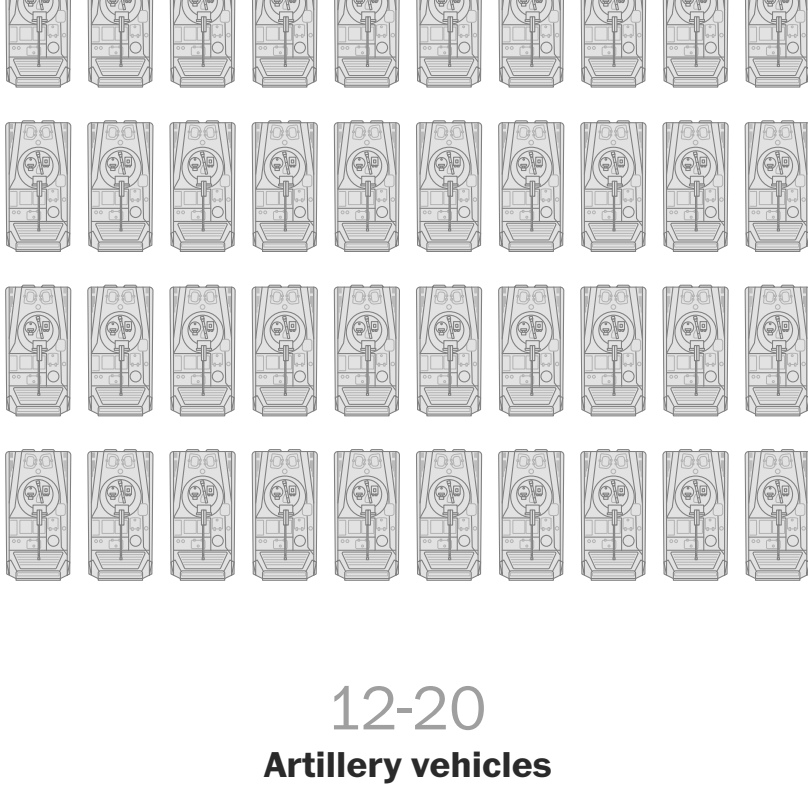

12-20

**Artillery vehicles**

Include cannons and possibly rocket launchers

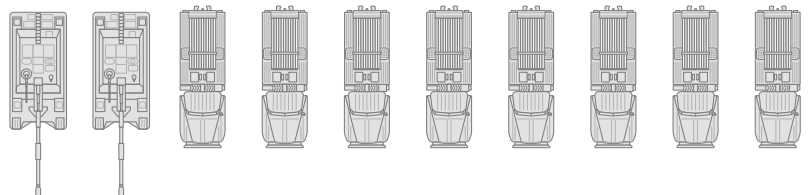

10

**Air defense vehicles**

Fire cannons, missiles or a mix

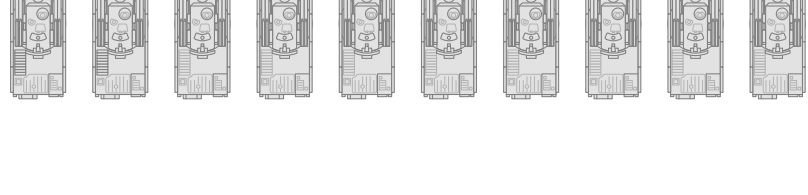

3

**Trucks for food**

Ten days' worth



5

**Water trucks**



2-5

**Medical trucks**

For front-line treatment (not equipped for surgeries)

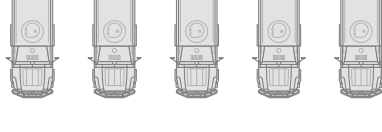

2

**Mobile kitchen trucks**

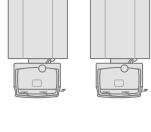

10-12

**Fuel trucks**

About two days' worth

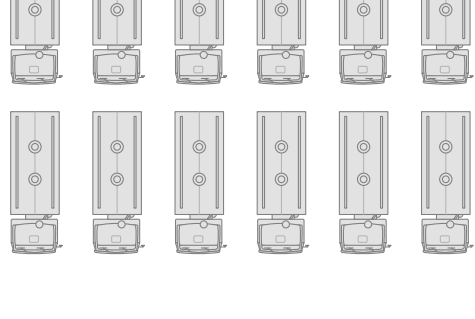

5

**Trucks with engineers and their supplies**

Mine-clearing equipment, for example

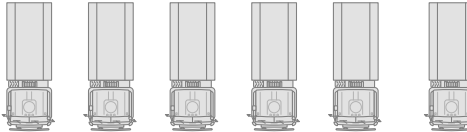

5

**Vehicles with drones**

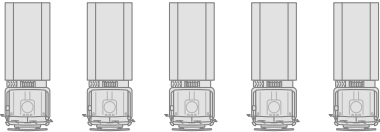

2

**Electronic signal jammers**

To neutralize spy satellites and radars

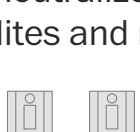

2

**Recovery vehicles**

One tow truck for lighter vehicles and one for towing tanks and cannons

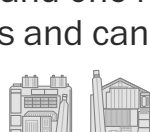

**Here's an example, a battalion tactical group, which would establish the front with 700 to 900 soldiers and an array of different types of vehicles.**

It is one of many types of formations used by the Russian army, according to retired Lt. Col. Alex Vershinin, whose career with U.S. and NATO forces included building logistical models.

10

**Tanks**

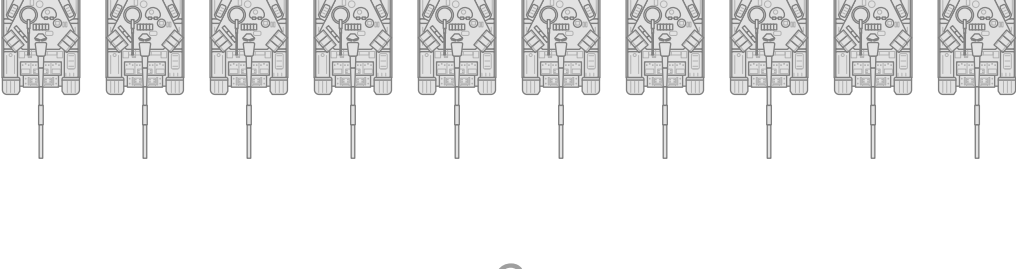

6

**Armored personnel carriers (APCs)**

With mortars mounted on top

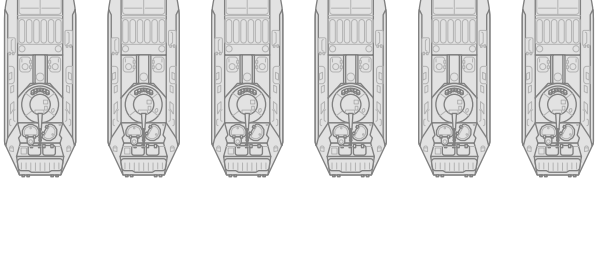

40

**Armored infantry fighting vehicles (IFVs)**

Carry troops into battle and usually have cannons mounted on them



12-20

**Artillery vehicles**

Include cannons and possibly rocket launchers

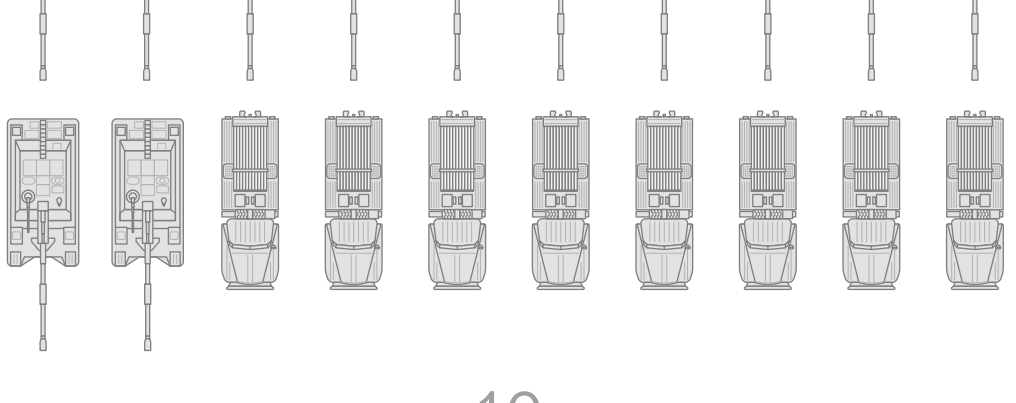

10

**Air defense vehicles**

Fire cannons, missiles or a mix

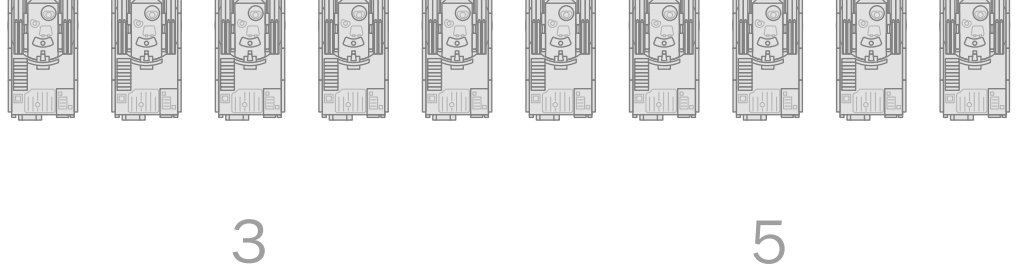

3

**Trucks for food**

Ten days' worth

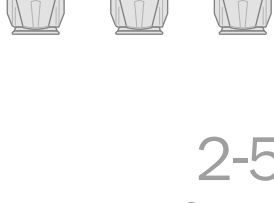

5

**Water trucks**



2-5

**Medical trucks**

For front-line treatment (not equipped for surgeries)



2

**Mobile kitchen trucks**

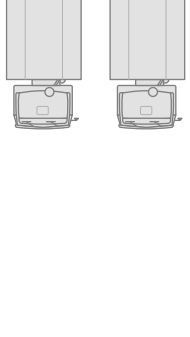

10-12

**Fuel trucks**

About two days' worth

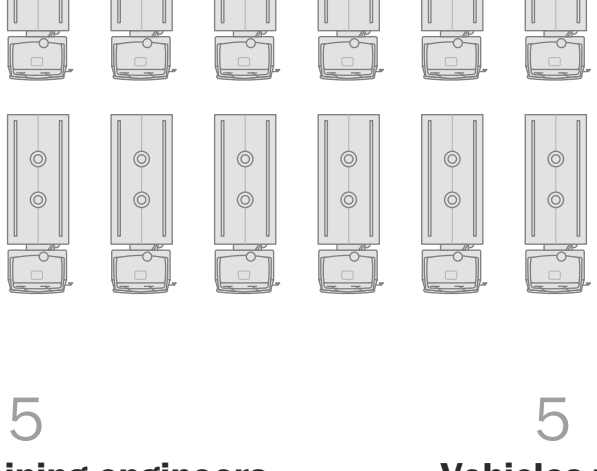

5

**Trucks containing engineers and their supplies**

Mine-clearing equipment, for example

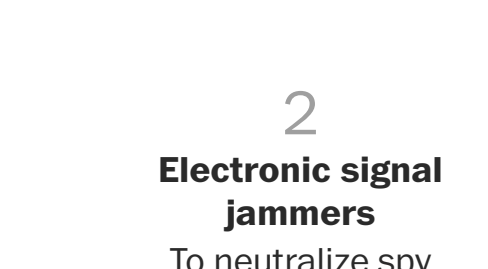

5

**Vehicles with drones**

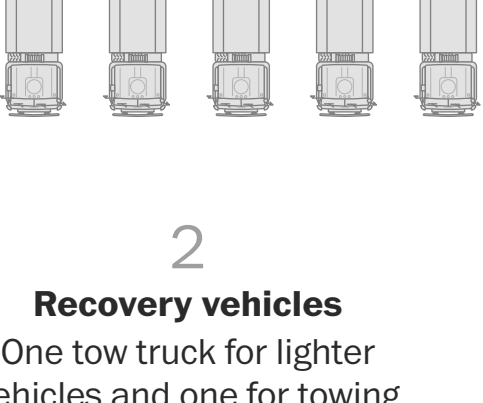

2

**Electronic signal jammers**

To neutralize spy satellites and radars



2

**Recovery vehicles**

One tow truck for lighter vehicles and one for towing tanks and cannons



**Here's an example, a battalion tactical group, which would establish the front with 700 to 900 soldiers and an array of different types of vehicles.**

It is one of many types of formations used by the Russian army, according to retired Lt. Col. Alex Vershinin, whose career with U.S. and NATO forces included building logistical models.

10

**Tanks**

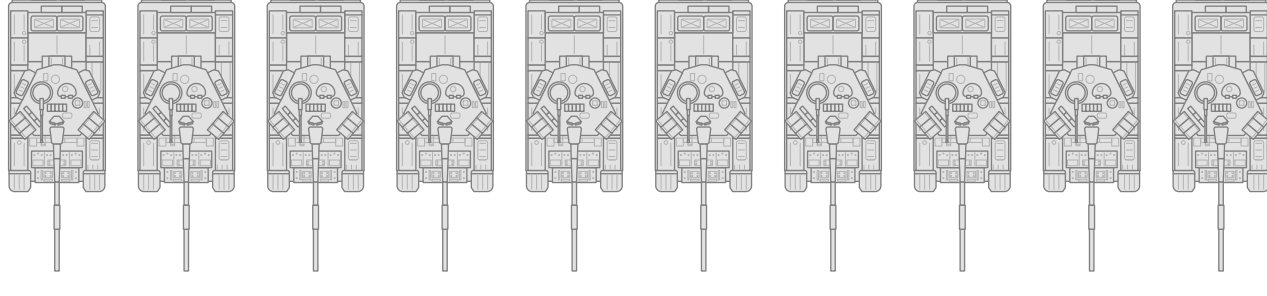

6

**Armored personnel carriers (APCs)**

With mortars mounted on top

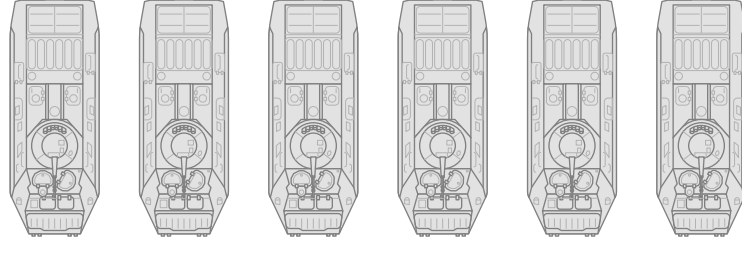

40

**Armored infantry fighting vehicles (IFVs)**

Carry troops into battle and usually have cannons mounted on them

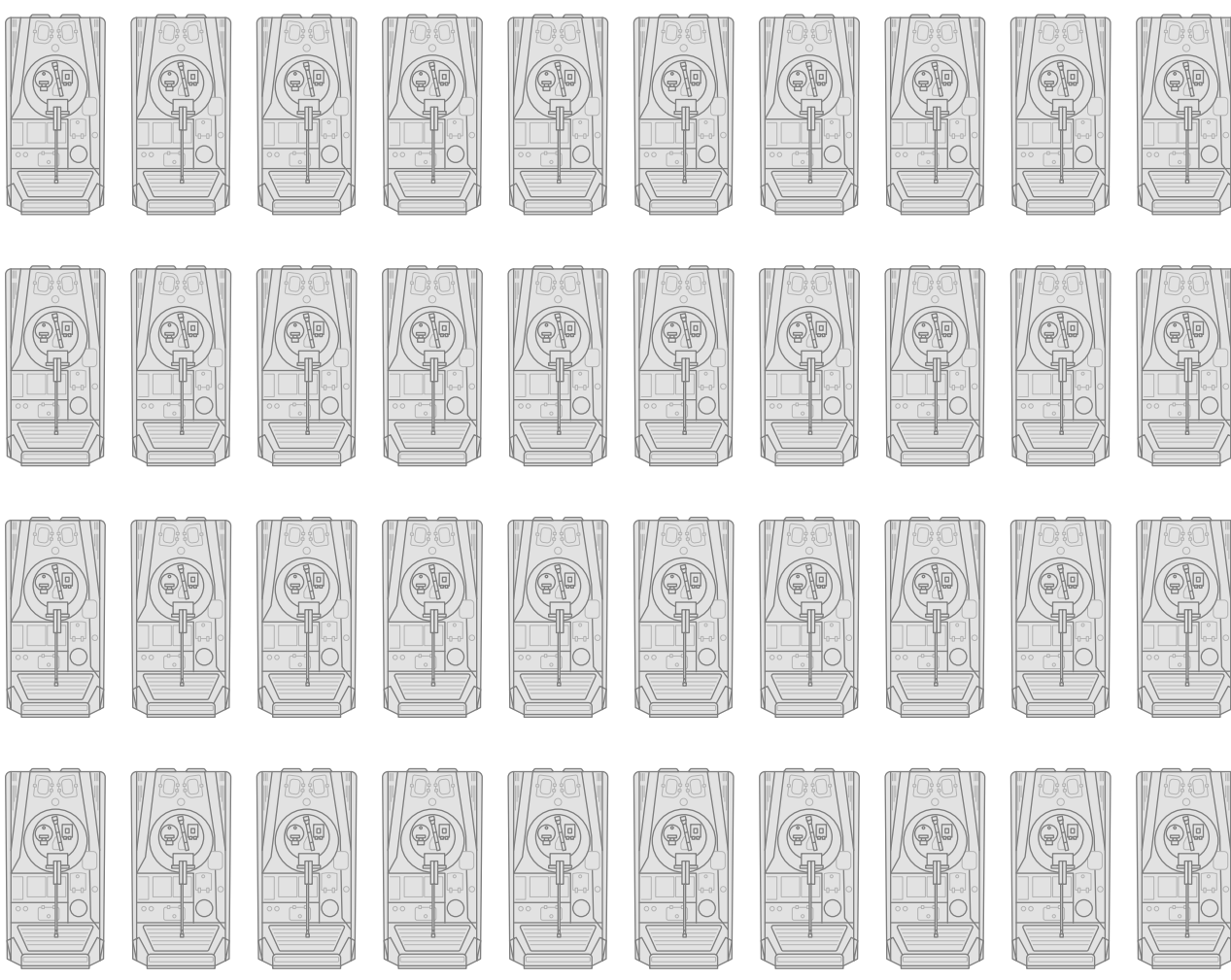

12-20

**Artillery vehicles**

Include cannons and possibly rocket launchers

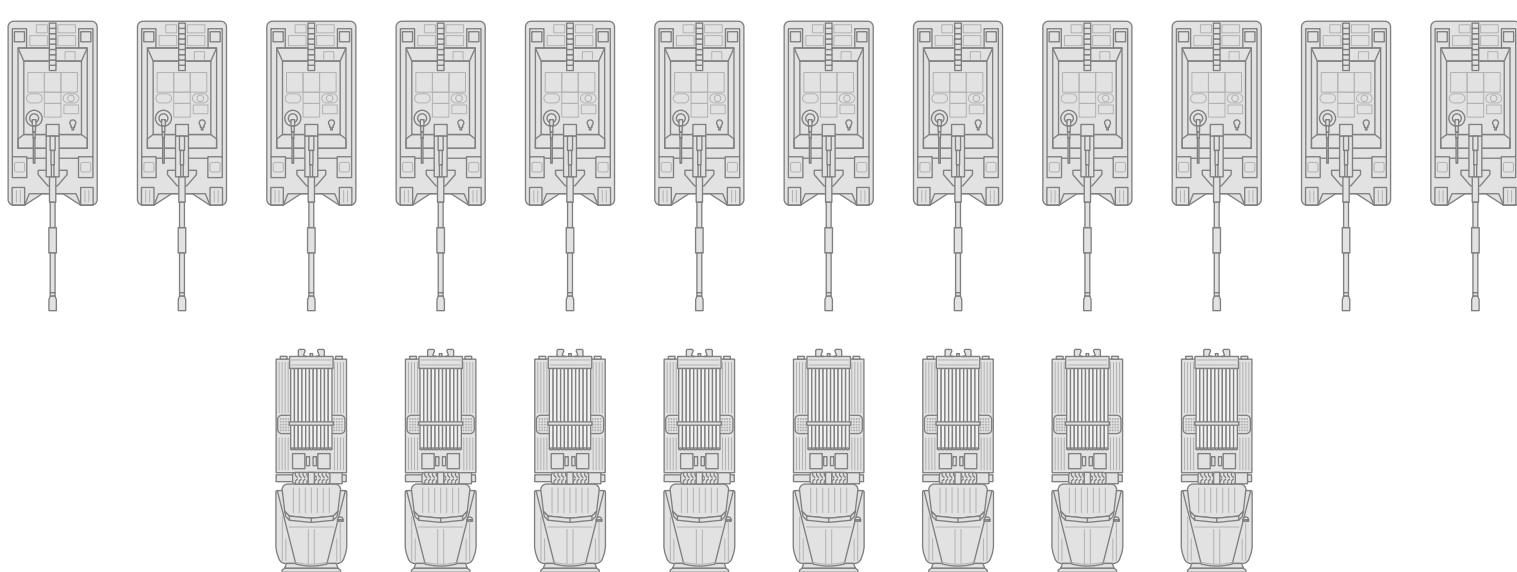

10

**Air defense vehicles**

Fire cannons, missiles or a mix

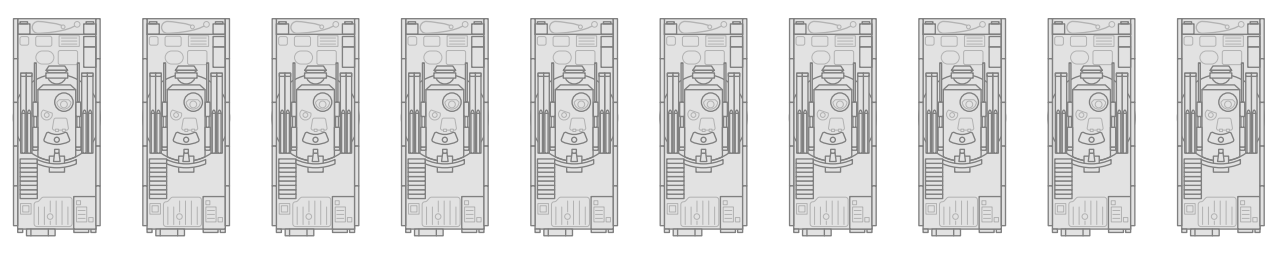

3

**Trucks for food**

Ten days' worth

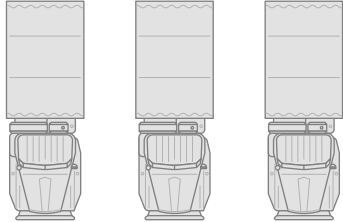

5

**Water trucks**

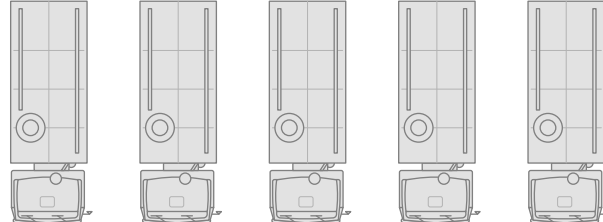

2-5

**Medical trucks**

For front-line treatment (not equipped for surgeries)

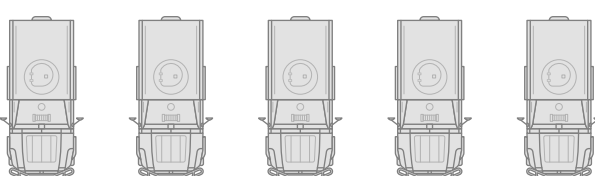

2

**Mobile kitchen trucks**

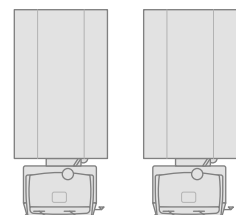

10-12

**Fuel trucks**

About two days' worth

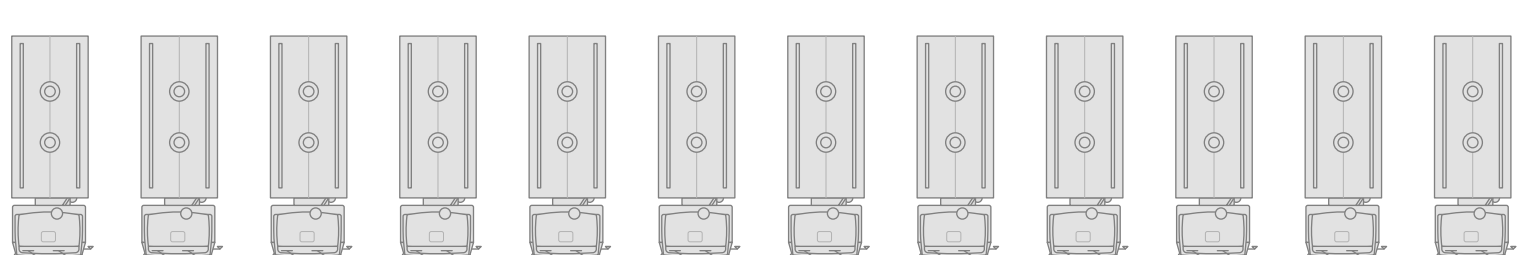

5

**Trucks containing engineers and their supplies**

Mine-clearing equipment, for example

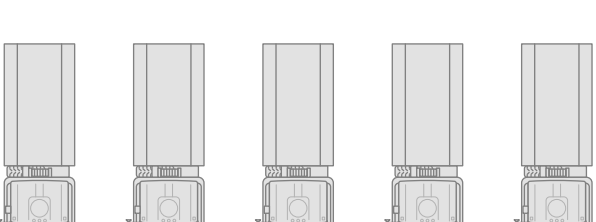

5

**Vehicles with drones**

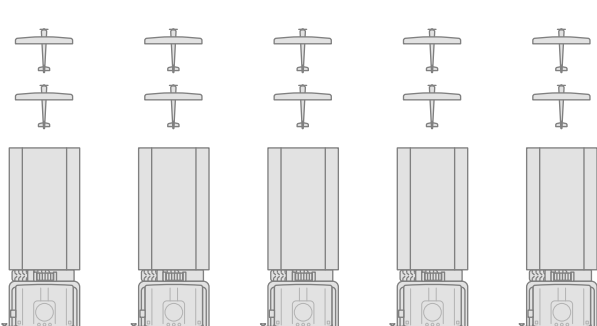

2

**Electronic signal jammers**

To neutralize spy satellites and radars

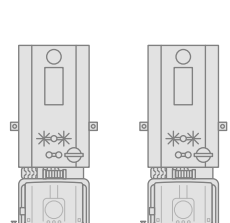

2

**Recovery vehicles**

One tow truck for lighter vehicles and one for towing tanks and cannons

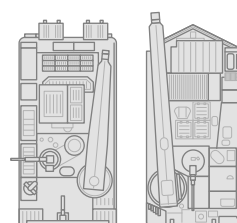

**Here's an example, a battalion tactical group, which would establish the front with 700 to 900 soldiers and an array of different types of vehicles.**

It is one of many types of formations used by the Russian army, according to retired Lt. Col. Alex Vershinin, whose career with U.S. and NATO forces included building logistical models.

10  
**Tanks**

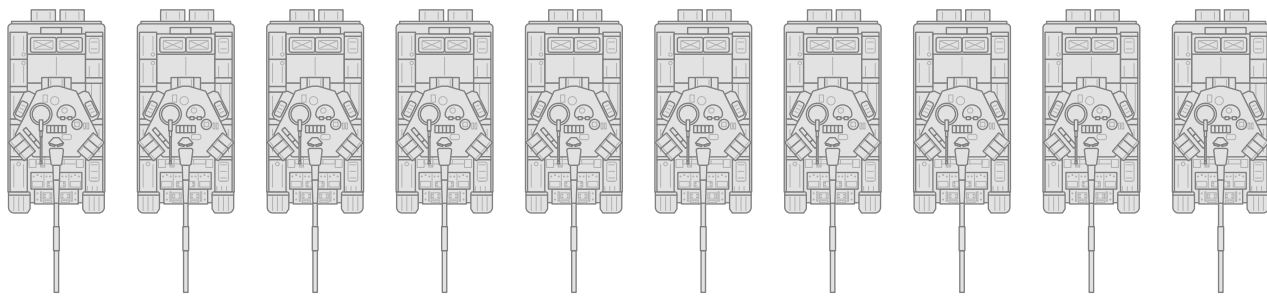

6

**Armored personnel carriers (APCs)**  
With mortars mounted on top

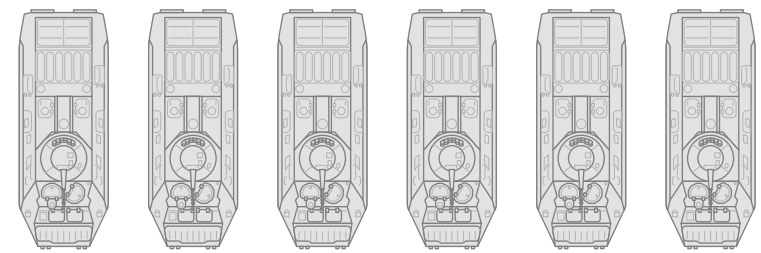

40

**Armored infantry fighting vehicles (IFVs)**

Carry troops into battle and usually have cannons mounted on them

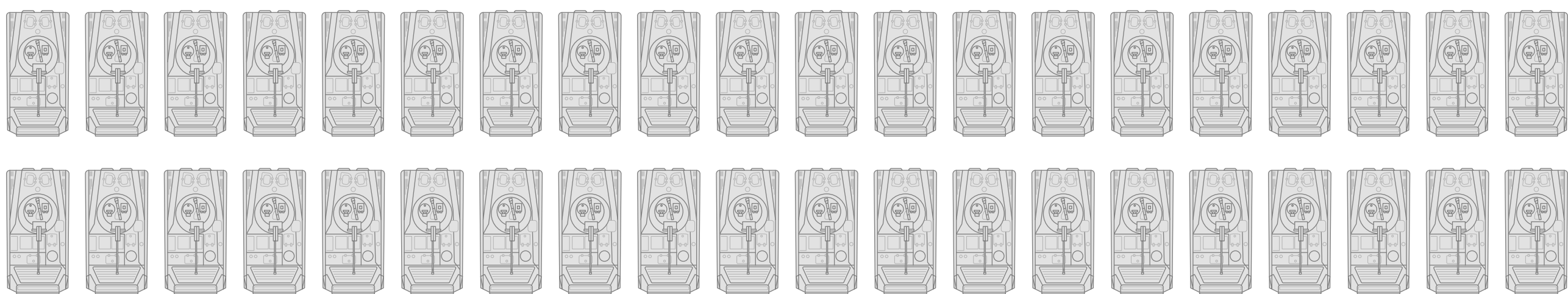

12-20

**Artillery vehicles**

Include cannons and possibly rocket launchers

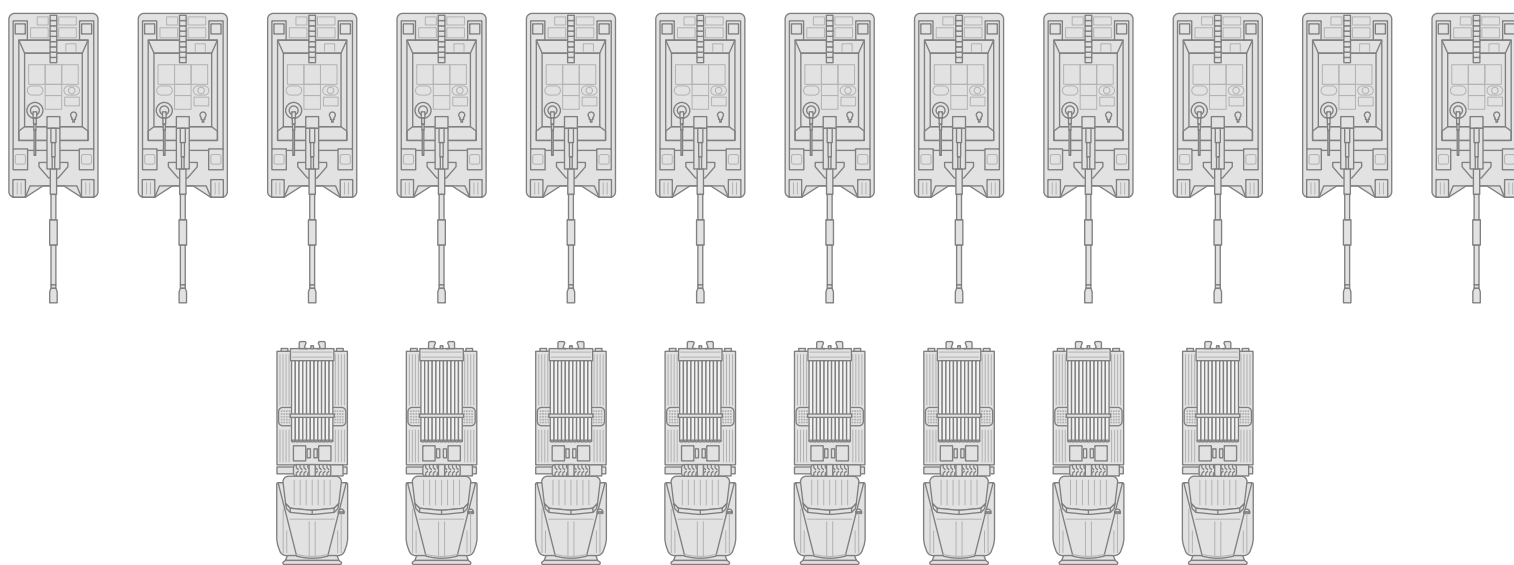

10

**Air defense vehicles**

Fire cannons, missiles or a mix

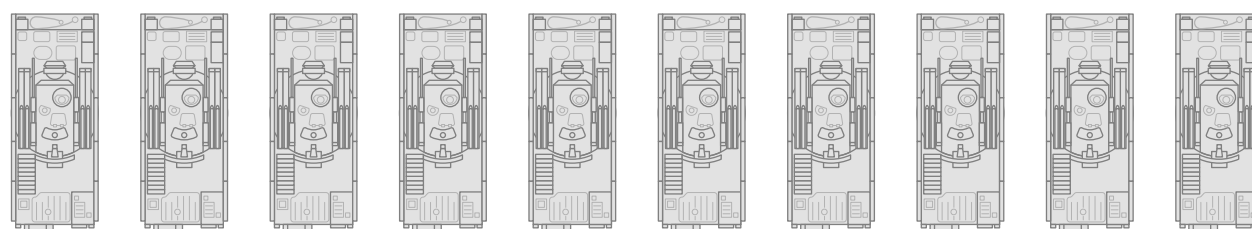

3

**Trucks for food**

Ten days' worth

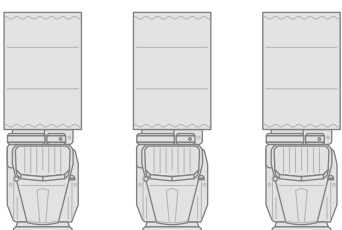

5

**Water trucks**

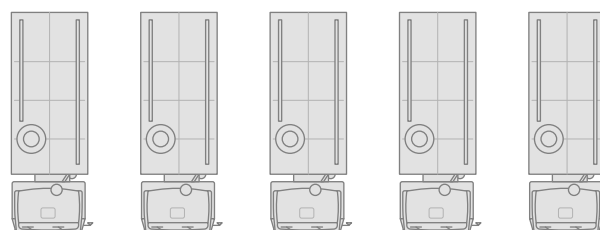

2-5

**Medical trucks**

For front-line treatment (not equipped for surgeries)

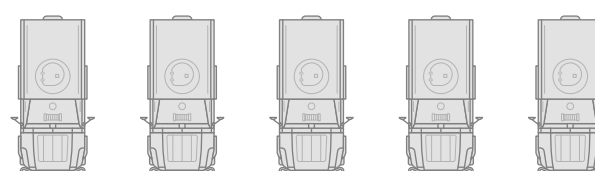

2

**Mobile kitchen trucks**

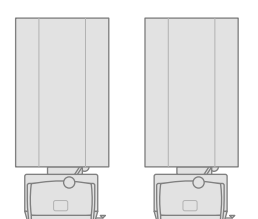

10-12

**Fuel trucks**

About two days' worth

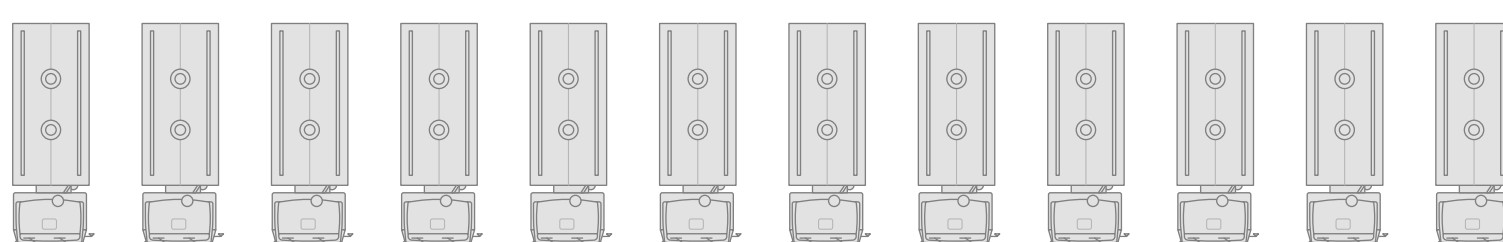

5

**Trucks containing engineers and their supplies**

Mine-clearing equipment, for example

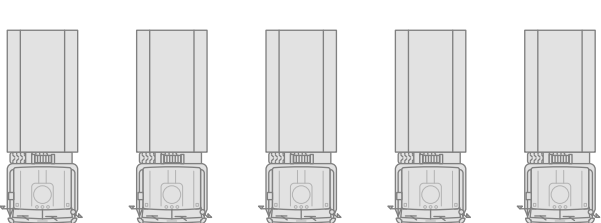

5

**Vehicles with drones**

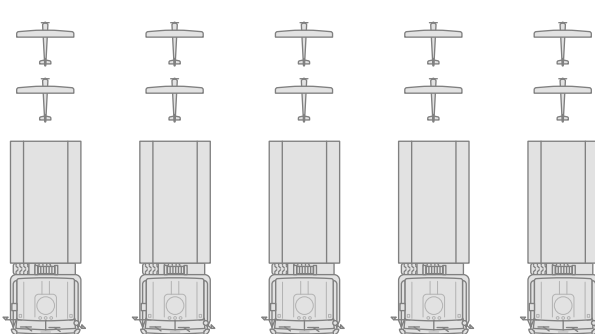

2

**Electronic signal jammers**

To neutralize spy satellites and radars

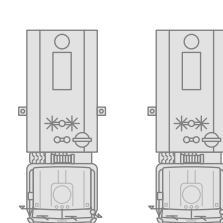

2

**Recovery vehicles**

One tow truck for lighter vehicles and one for towing tanks and cannons

