



United States Department of Agriculture

---

# Pinto Valley Mine

## Final Environmental Impact Statement

### Volume 3 (Appendix H)



Forest Service

Tonto National Forest

MB-R3-12-09

April 2021

In accordance with Federal civil rights law and U.S. Department of Agriculture (USDA) civil rights regulations and policies, the USDA, its Agencies, offices, and employees, and institutions participating in or administering USDA programs are prohibited from discriminating based on race, color, national origin, religion, sex, gender identity (including gender expression), sexual orientation, disability, age, marital status, family/parental status, income derived from a public assistance program, political beliefs, or reprisal or retaliation for prior civil rights activity, in any program or activity conducted or funded by USDA (not all bases apply to all programs). Remedies and complaint filing deadlines vary by program or incident.

Persons with disabilities who require alternative means of communication for program information (e.g., Braille, large print, audiotope, American Sign Language, etc.) should contact the responsible Agency or USDA's TARGET Center at (202) 720-2600 (voice and TTY) or contact USDA through the Federal Relay Service at (800) 877-8339. Additionally, program information may be made available in languages other than English.

To file a program discrimination complaint, complete the USDA Program Discrimination Complaint Form, AD-3027, found online at [http://www.ascr.usda.gov/complaint\\_filing\\_cust.html](http://www.ascr.usda.gov/complaint_filing_cust.html) and at any USDA office or write a letter addressed to USDA and provide in the letter all of the information requested in the form. To request a copy of the complaint form, call (866) 632-9992. Submit your completed form or letter to USDA by: (1) mail: U.S. Department of Agriculture, Office of the Assistant Secretary for Civil Rights, 1400 Independence Avenue, SW, Washington, D.C. 20250-9410; (2) fax: (202) 690-7442; or (3) email: [program.intake@usda.gov](mailto:program.intake@usda.gov).

USDA is an equal opportunity provider, employer and lender.

**Appendix H. Environmental Protection  
Measures, Monitoring, and  
Mitigation**



## Table of Contents

<b>1.0</b>	<b>Introduction</b> .....	<b>H-1</b>
<b>2.0</b>	<b>Environmental Protection Measures</b> .....	<b>H-1</b>
<b>3.0</b>	<b>Environmental Protection Measures Required by Other Agencies</b> .....	<b>H-2</b>
<b>4.0</b>	<b>Proposed Monitoring and Mitigation</b> .....	<b>H-3</b>
4.1	Mitigation under the National Environmental Policy Act .....	H-3
4.2	Role of the Tonto National Forest.....	H-3
4.3	Role of Pinto Valley Mining Corp. ....	H-4
4.4	Proposed Monitoring and Mitigation Measures.....	H-4
4.4.1	General Mitigation Measures .....	H-4
4.4.2	Air Quality .....	H-13
4.4.3	Biological Resources (Vegetation, Fish and Wildlife, Special Status Species).....	H-14
4.4.4	Cultural Resources .....	H-17
4.4.5	Tribal Resources of Concern .....	H-19
4.4.6	Fire and Fuels Management .....	H-20
4.4.7	Geology, Minerals, and Geotechnical Stability .....	H-21
4.4.8	Livestock Grazing .....	H-25
4.4.9	Public Health and Safety .....	H-26
4.4.10	Soils .....	H-27
4.4.11	Traffic and Transportation .....	H-28
4.4.12	Water Resources and Hydrogeochemistry .....	H-33
<b>5.0</b>	<b>References</b> .....	<b>H-38</b>

## List of Attachments

- Attachment A – Biological Resources Monitoring and Mitigation Plan
- Attachment B – Open Pit Wall Stability and Mitigation Plan
- Attachment C – Post-Closure Stormwater Control, Inspection, and Maintenance Plan
- Attachment D – Comprehensive Water Resource Monitoring and Mitigation Plan
- Attachment E – Post-Closure Tailings Seepage Management and Mitigation Plan

## Acronyms and Abbreviations

CFR	Code of Federal Regulations
EIS	environmental impact statement
Forest Service	U.S. Department of Agriculture, U.S. Forest Service

## 1.0 Introduction

This appendix presents environmental protection measures currently being employed at the Pinto Valley Mine, measures required by other agencies, and agency-proposed mitigation measures and monitoring plans that could be applied to the selected action to minimize potential adverse impacts analyzed in the Pinto Valley Mine Environmental Impact Statement (EIS). The analysis of impacts in chapter 3, “Affected Environment and Environmental Consequences,” of the EIS considers the effects of these mitigation measures in the disclosure of potential impacts.

Monitoring and mitigation requirements that are within the jurisdiction of the U.S. Department of Agriculture, Forest Service (Forest Service) and deemed necessary for the approval of the selected action in the mining plan of operations will be identified in the final record of decision for inclusion in the final mining plan of operations prior to Forest Service approval.

## 2.0 Environmental Protection Measures

The environmental analysis considered in this EIS includes environmental protection measures (design features) proposed and employed by Pinto Valley Mining Corp. to reduce potential adverse environmental effects. These measures are nondiscretionary, as they are part of the proposed action, as described in more detail in chapter 2, “Proposed Action and Alternatives,” of the EIS.

Existing applicant-committed environmental protection measures include but are not limited to:

- Air Resources
  - Pinto Valley Mining Corp. has developed a fugitive dust control plan as an operational manual that describes the methods used to ensure compliance with the particulate matter emissions requirements of the air quality control permit (see section 3.0).
- Fire Management
  - Pinto Valley Mining Corp. has trained employees in initial fire response and many are members of the emergency response and emergency management teams. Many mine vehicles are equipped with fire extinguishers and water trucks are located on site and are available to control fire until help arrives. Pinto Valley Mining Corp. coordinates with the Tonto National Forest as needed to support firefighting efforts on and in the vicinity of Pinto Valley Mine; all fires on National Forest System lands will be reported to the Forest Service Dispatcher’s office even if the fire is extinguished.
- Safety
  - Pinto Valley Mining Corp. has worked with the Tonto National Forest to restrict access to areas subject to blasting to ensure public and operational safety.
  - Pinto Valley Mining Corp. monitors pit slope stability on a continuous basis to detect ground movement that could affect mining operations or result in upslope disturbance.
  - Pinto Valley Mining Corp. assesses the stability of tailings storage facility embankments and waste rock dumps to ensure that the facilities meet good engineering practice standards. These facilities are inspected and assessed on a regular basis.
- Traffic
  - Pinto Valley Mining Corp. encourages employees to carpool or work remotely, when practicable, to minimize vehicle traffic on U.S. Highway 60 and Pinto Valley Road (National Forest System Road 287).

- Water
  - Pinto Valley Mining Corp. continuously evaluates operating procedures to improve water use efficiency through reuse, minimize loss through leaks and evaporation, and implement alternative technologies that use less water than conventional procedures.
  - Pinto Valley Mining Corp. also applies an operations and maintenance manual for catchment ponds, reservoirs, and tailings storage facilities that identifies best management practices, maintenance, and inspection to manage and prevent the unauthorized discharge of storm water at the Pinto Valley Mine (Oracle Environmental 2016).

### **3.0 Environmental Protection Measures Required by Other Agencies**

There are other regulatory agencies that have permitting, compliance, and reporting requirements for the Pinto Valley Mine (such as the Arizona Department of Environmental Quality and Arizona State Mine Inspector). Requirements of these other agencies are relevant to the evaluation of environmental effects in the Pinto Valley Mine EIS and monitoring and mitigation requirements but are not authorized or overseen by the Forest Service. Permits and authorizations administered by these other agencies establish resource protection requirements for a range of resources. In general, these measures are nondiscretionary as they are required under existing permits and authorizations for the Pinto Valley Mine.

The primary existing authorizations and permits from other agencies for facilities and activities at the Pinto Valley Mine that are relevant to environmental protection are listed in table 1-2 in the final EIS and summarized below.

- Arizona Department of Environmental Quality's Aquifer Protection Permit includes terms and conditions that specify how groundwater will be protected by certain design, operation, monitoring, and response requirements. The Aquifer Protection Permit includes a variety of monitoring requirements for groundwater, water levels, discharges, and best available demonstrated control technology, including the protection of groundwater from tailings storage facility discharge. The Aquifer Protection Permit also requires a closure and post-closure strategy that describes how facilities will be closed when operations are complete. The Arizona Department of Environmental Quality currently holds a financial bond posted by Pinto Valley Mining Corp. as stipulated in its permit.
- Arizona Department of Environmental Quality's Authorization to Discharge under the Arizona Pollutant Discharge Elimination System authorizes Pinto Valley Mining Corp. to discharge storm water mixed with mine process water and mine drainage from facilities at Pinto Valley Mine. This permit establishes effluent limitations, monitoring requirements, and other conditions to minimize discharge of pollutants to surface waters.
- Arizona Department of Environmental Quality's Notice of Intent Certificate to comply with the Arizona Storm Water Multi-Sector General Permit requires Pinto Valley Mining Corp. to maintain a storm water pollution prevention plan for managing, monitoring, and controlling storm water to minimize pollutants in storm water discharges.
- Arizona Department of Environmental Quality's Air Quality Class II "synthetic minor" emissions control permit includes voluntarily accepted and federally enforceable emission and operating limits and air pollution control requirements. In accordance with Pinto Valley Mining Corp.'s air quality permit, Pinto Valley Mining Corp. applies a visual observation plan that requires Pinto Valley Mining Corp. to conduct readings, testing, and visual observations



of emissions from point sources, fugitive sources, and other equipment to determine opacity levels.

- Arizona State Mine Inspector requires a Mined Land Reclamation Plan that describes closure and reclamation of infrastructure and includes provisions for end-of-mine protection of public safety. Additionally, Arizona State Mine Inspector holds a financial bond posted by Pinto Valley Mining Corp. to ensure reclamation activities occur as described in the Mined Land Reclamation Plan.
- Arizona Department of Water Resources' permits for Pinto Valley Mining Corp.'s Peak Wells require that well abandonment and reclamation occur in accordance with procedures enumerated at Arizona Revised Statutes 45-594 and Arizona Administrative Code R12-15-816 to prevent the possibility for groundwater contamination.
- The U.S. Environmental Protection Agency requires a spill prevention, control, and countermeasures plan to address storage and containment of spills of petroleum and non-petroleum products.

## 4.0 Proposed Monitoring and Mitigation

This section presents the monitoring and mitigation measures that have been developed to minimize the adverse impacts on National Forest System lands as identified in chapter 3 of the Pinto Valley Mine EIS. The final monitoring and mitigation measure requirements will be included in the record of decision and will be incorporated into the final mining plan of operations prior to agency approval.

### 4.1 Mitigation under the National Environmental Policy Act

Mitigation is an important mechanism that Federal agencies can use to minimize the potential adverse environmental impacts associated with their actions. As described in the Council on Environmental Quality regulations at Title 40, part 1508.1(s) of the Code of Federal Regulations (CFR), mitigation refers to measures that avoid, minimize, or compensate for effects caused by a proposed action or alternatives as described in an environmental document or record of decision and that have a nexus to those effects. While the National Environmental Policy Act requires consideration of mitigation, it does not mandate the form or adoption of any mitigation. In accordance with 40 CFR 1508.1(s), mitigation can include:

- Avoiding the impact altogether by not taking a certain action or parts of an action
- Minimizing impacts by limiting the degree or magnitude of the action and its implementation
- Rectifying the impact by repairing, rehabilitating, or restoring the affected environment
- Reducing or eliminating the impact over time by preservation and maintenance operations during the life of the action
- Compensating for the impact by replacing or providing substitute resources or environments

### 4.2 Role of the Tonto National Forest

The role of the Tonto National Forest under its primary authorities in the Organic Administration Act, Surface Resources Act of 1955, and the Locatable Regulations (36 CFR 228 subpart A) is to ensure that mining activities minimize adverse environmental effects on National Forest System surface resources to the extent practicable. The Forest Service may impose reasonable conditions to protect

surface resources but cannot materially interfere with reasonably necessary activities under the General Mining Law of 1872 that are otherwise lawful. The Forest Service's authority related to mitigation is limited to protection of surface resources of National Forest System lands (see 30 U.S. Code 612, 5 U.S. Code 551, and 36 CFR 228.1). Unless otherwise noted, mitigation and monitoring measures listed in this appendix are within the authority of the Forest Service.

Pinto Valley Mining Corp.'s activities at Pinto Valley Mine are also subject to compliance with other applicable Federal regulations. As a result, the mitigation and monitoring measures presented below also include measures from the biological opinion (see appendix D, "Biological Opinion," of the Pinto Valley Mine EIS) resulting from the Endangered Species Act section 7 consultation process with the U.S. Fish and Wildlife Service in addition to measures from the Memorandum of Agreement (2020) and Historic Property Treatment Plan (2019) associated with the National Historic Preservation Act section 106 consultation process with the Arizona State Historic Preservation Office and other consulting parties.

The effectiveness of the identified monitoring and mitigation measures would be evaluated on a regular basis by both the Forest Service and Pinto Valley Mining Corp. It is expected that, in certain cases, monitoring and mitigation may need to be adapted to changing circumstances to ensure their effectiveness over the duration of the selected action.

### 4.3 Role of Pinto Valley Mining Corp.

While the Forest Service seeks to coordinate with other agencies to approve a legally compliant final mining plan of operations, it is the operator's responsibility to ensure that its actions comply with all applicable laws. Therefore, it is the responsibility of Pinto Valley Mining Corp. to ensure that the monitoring and mitigation measures included in the record of decision and final approved mining plan of operations are implemented and all reporting requirements are fulfilled on time.

## 4.4 Proposed Monitoring and Mitigation Measures

Specific monitoring and mitigation measures identified through the National Environmental Policy Act review process are listed under each applicable resource heading below. Monitoring and mitigation requirements described below that are within the jurisdiction of the Forest Service and deemed necessary for the approval of the selected action in the mining plan of operations will be identified in the final record of decision.

### 4.4.1 General Mitigation Measures

#### Mitigation Measure MM-1: Annual Status Report to the Forest Service

**Resource affected/impacts being mitigated:**

Ensuring effective coordination between the Forest Service and Pinto Valley Mining Corp. during operations, closure, and post-closure.

**Description of mitigation measure:**

Pinto Valley Mining Corp. would provide the Forest Service an annual summary of mining operations, reclamation, and other activities on National Forest System lands that occurred in the previous year and an overview of planned mining activities in the upcoming year. The status report would include a summary of mine area expansion (location and acres),

reclamation activities, a summary of monitoring activities and results (such as a summary of activities conducted under the comprehensive water resource monitoring and mitigation plan), a list of other monitoring reports and dates provided to other regulatory agencies, and other appropriate information relevant to activities and potential impacts on National Forest System lands including but not limited to evidence of review and update, if needed, of the operating plans identified in Mitigation Measure MM-3. The format of the annual status report will be developed by the Forest Service and Pinto Valley Mining Corp. prior to submittal of the first report.

**Measure timing:**

Annual status report would be required during operation, closure, and post-closure.

**Source of measure:**

Developed by the Forest Service

**Applicable alternatives:**

Proposed action and alternative 1

**Authority to require:**

Authority is provided under 36 CFR 228, subpart A (§228.13).

**Additional ground disturbance or other impacts that could result from implementation of this mitigation measure:**

There would be no surface disturbance or other impacts associated with this measure.

**Effectiveness of the mitigation measure:**

Annual operating plans would provide a tool to ensure effective coordination of project status and review of mitigation effectiveness via monitoring results for activities on or that could affect National Forest System lands.

**Mitigation Measure MM-2: Updating and Maintaining Plans during Operations, Closure, and Post-Closure**

**Resource affected/impacts being mitigated:**

The range of resources on National Forest System lands covered in operational plans and monitoring and mitigation plans.

**Description of mitigation measure:**

Pinto Valley Mining Corp. would maintain and review annually all required monitoring and mitigation plans and operating plans that are included or part of the overall approved mining plan of operations. During annual reviews of plans, Pinto Valley Mining Corp. would determine if there is new information, changing circumstances, or other factors that require updates.

The plans that would require an annual assessment would include but not be limited to:

- **Monitoring and Mitigation Plan**
  - Biological Resources Monitoring and Mitigation Plan
  - Open Pit Wall Stability and Mitigation Plan
  - Post-Closure Stormwater Control, Inspection, and Maintenance Plan

- Comprehensive Water Resources Monitoring and Mitigation Plan
- Post-Closure Tailings Seepage Management and Mitigation Plan
- **Operating Plans**
  - Fugitive Dust Control Plan
  - Road Use and Maintenance Plan
  - Emergency Action Plan
  - Noxious Weed Control Plan
  - Health and Safety Plan
  - Hazardous Materials Management Plan
  - Fire Prevention Plan
  - Explosives Management Plan
  - Stormwater Pollution Prevention Plan
  - National Forest System Land Reclamation Plan
  - Interim Closure Plan

**Measure timing:**

Plans would be reviewed annually during operations, closure, and post-closure and updated as needed.

**Source of measure:**

Developed by the Forest Service

**Applicable alternatives:**

Proposed action and alternative 1

**Authority to require:**

Authority is provided under 36 CFR 228, subpart A (§228.4).

**Additional ground disturbance or other impacts that could result from implementation of this mitigation measure:**

There would be no surface disturbance or other impacts associated with this measure.<sup>1</sup>

**Effectiveness of the mitigation measure:**

Annual reviews and as-needed updates to operating plans and monitoring and mitigation plans would provide a mechanism to adjust these plans if there are identified new circumstances, new information, or other factors to ensure that the plans are adapted to meet their overall objectives.

---

<sup>1</sup> In general, updating and maintaining plans would not trigger the need for additional analysis under the National Environmental Policy Act. However, additional National Environmental Policy Act review may be required if there are necessary updates or proposed changes to monitoring and mitigation measures that are beyond the scope of activities and impacts analyzed in this final EIS.

### **Mitigation Measure MM-3: Interim Shutdown Procedures**

**Resource affected/impacts being mitigated:**

Potential impacts on the range of resources that could result from interim shutdown of the mine.

**Description of mitigation measure:**

Pinto Valley Mining Corp. will be required to execute the interim closure plan as described in the approved mining plan of operations no later than 60 days after any potential cessation of operations on National Forest System lands. No later than 60 days after cessation of operations, Pinto Valley Mining Corp. will also submit for approval by the Forest Service an updated detailed closure plan for activities on National Forest System lands that meets the requirements of CFR 228.10 and includes specific actions to be taken to secure and stabilize the site, an anticipated date for recommencement of operations with a revised mine life schedule, or a date for implementation of final reclamation and closure.

Upon approval of the updated interim closure plan, Pinto Valley Mining Corp. will execute the updated plan in lieu of the conceptual interim closure plan in the mining plan of operations. At this time, Pinto Valley Mining Corp. will need to ensure compliance with requirements under 36 CFR 228.10 for cessation of operations, including the requirement for submittal of annual statements (36 CFR 228.10(c)). Pinto Valley Mining Corp. will also review the interim closure plan on an annual basis and supply an updated plan when substantive changes are warranted for approval by the Forest Service. For the duration of interim closure activities, the Forest Service may also choose to conduct annual bond reviews and recalculations, regardless of the previous planned bonding schedule. The Forest Service may direct Pinto Valley Mining Corp. to implement final reclamation and closure plans on National Forest System lands in the event that Pinto Valley Mining Corp. is in noncompliance with requirements contained in the record of decision and final mining plan of operations, including required monitoring, best management practices, mitigation, and security, or in the event that the approved dates contained in the updated interim closure plan for recommencement of operations or implementation of final reclamation and closure have been exceeded.

**Measure timing:**

This measure would be applied if there is a temporary cessation of active mining that requires interim shutdown of the Pinto Valley Mine.

**Source of measure:**

Developed by the Forest Service

**Applicable alternatives:**

Proposed action and alternative 1

**Authority to require:**

Authority is provided under 36 CFR 228, subpart A, regarding the cessation of operations and removal of structures and equipment (§228.10).

**Additional ground disturbance or other impacts that could result from implementation of this mitigation measure:**

There would be no surface disturbance or other impacts associated with this measure.

**Effectiveness of the mitigation measure:**

The development and maintenance of an updated interim closure plan with specific actions would ensure that interim shutdown procedures are appropriate and approved in a timely manner to reduce potential impacts on National Forest System lands from temporary cessation of mining operations.

**Mitigation Measure MM-4: National Forest System Land Reclamation Plan**

**Resource affected/impacts being mitigated:**

Existing and proposed surface disturbance on National Forest System lands and associated impacts on the long-term productivity of soils, vegetation, and other ecosystem components.

**Description of mitigation measure:**

Pinto Valley Mining Corp. will prepare a reclamation plan as part of the overall mining plan of operations that is specific to all areas of existing and proposed disturbance and reclamation on National Forest System lands, including but not limited to the 19 Dump, Cottonwood Tailings Impoundment, Tailings Storage Facilities No. 3 and No. 4, power line and corridors, pipeline and corridors, and roads on National Forest System lands. The reclamation plan will describe decommissioning and reclamation of inactive facilities that would occur in the near term and decommissioning and reclamation of facilities that would occur during the reclamation and closure phase. The reclamation plan will identify reclamation standards, objectives, and practices to meet desired conditions and land uses following closure of the mine. The reclamation plan would be reviewed and approved by the Forest Service prior to new disturbance on National Forest System lands.

Components of the reclamation plan on National Forest System lands would include but not be limited to soil surveys and soil characterization, soil or growth media to be used, balance of reclamation need compared to salvage available, target post-mining land uses, reclamation success criteria, measures taken to ensure soil productivity and revegetation (such as type and amount of seed and plant mixes, weed-free products, and application rates of mulch or soil supplements), description of reclamation phases and schedule (such as concurrent reclamation, interim reclamation, or final reclamation), and other measures that will be taken to meet the defined success criteria for target post-mining land uses on National Forest System lands.

**Measure timing:**

The reclamation plan will be applied for existing and proposed surface disturbance on National Forest System lands.

**Source of measure:**

Developed by the Forest Service

**Applicable alternatives:**

Proposed action and alternative 1

**Authority to require:**

Authority is provided under 36 CFR 228, subpart A, which indicates that all operations shall be conducted so as, where feasible, to minimize adverse environmental impacts on national forest surface resources (§228.8) and that an operator shall reclaim the surface disturbed in

operations by taking such measures as will prevent or control on-site and off-site damage to the environment and forest surface resources (§228.8(g)).

**Additional ground disturbance or other impacts that could result from implementation of this mitigation measure:**

There would be no additional ground disturbance associated with this mitigation measure. Potential surface disturbance areas associated with reclamation (such as borrow and riprap sources) are described and accounted for in the estimates of surface disturbance for the alternatives in chapter 2, "Proposed Action and Alternatives," of the EIS and activities associated with reclamation (such as reclamation emissions, workforce, and noise) are described in the disclosure of environmental consequences in chapter 3, "Affected Environment and Environmental Consequences," of the EIS.

In general, reclamation activities could result in surface disturbance due to extraction of borrow and riprap sources, recontouring and grading, removal of culverts and other infrastructure, and other activities. However, in most cases, reclamation-related disturbance would be occurring in areas that have already been disturbed. In general, development and application of a reclamation plan for National Forest System lands would result in beneficial impacts on surface resources by committing Pinto Valley Mining Corp. to specific reclamation activities to achieve desired reclamation objectives and post-mining land uses.

**Effectiveness of the mitigation measure:**

This measure would require Pinto Valley Mining Corp. to meet measurable performance standards for revegetation, stability, post-mining land configuration, and other reclamation outcomes. These standards would be developed by Pinto Valley Mining Corp. for approval by the Forest Service in accordance with Forest Service Manual 2840. Reclamation standards on National Forest System lands may be more stringent than State standards that apply to adjacent private lands. The reclamation plan could have beneficial effects on a range of resources by reestablishing native vegetation communities and wildlife habitat, and planning for post-closure land uses.

**Mitigation Measure MM-5: Post-Closure Maintenance and Monitoring**

**Resource affected/impacts being mitigated:**

Potential impacts on the range of resources that could persist longer than Pinto Valley Mining Corp.'s proposed 3-year maintenance period and the 30-year monitoring period.

**Description of mitigation measure:**

As part of the initial bond calculation process and subsequent bond update processes, the Forest Service will conduct an evaluation of long-term risks of the post-closure conditions and reclamation requirements and adequacy of the 3-year maintenance period and 30-year post-closure timeframes. If site conditions or monitoring indicates that impacts are likely to occur after Pinto Valley Mining Corp.'s proposed 3-year maintenance period and the 30-year post-closure monitoring period (such as reclamation success criteria not being met, or water quality monitoring exceeding established thresholds), Pinto Valley Mining Corp. would coordinate with the Forest Service to continue ongoing maintenance, monitoring, and mitigation activities beyond their proposed periods until the potential issues are resolved.

**Measure timing:**

The measure would be applied during the post-closure period.

**Source of measure:**

Developed by the Forest Service.

**Applicable alternatives:**

Proposed action and alternative 1

**Authority to require:**

Authority is provided under 36 CFR 228, subpart A, which indicates that operations shall be conducted to minimize adverse environmental impacts on national forest surface resources (§228.8).

**Additional ground disturbance or other impacts that could result from implementation of this mitigation measure:**

Potential extended post-closure maintenance and monitoring activities would result in the continuance of occasional noise, human presence, and ground disturbance as described for maintenance and monitoring activities during the 3-year maintenance period and the 30-year post-closure monitoring period under the proposed action in the Pinto Valley Mine EIS. No notable environmental effects are anticipated from the extension of these activities because they would take place within areas of authorized surface disturbance and would ensure that reclamation success criteria are being met and all post-closure systems are functioning properly.

**Effectiveness of the mitigation measure:**

Providing ongoing monitoring and maintenance activities beyond the proposed 3-year maintenance period and the 30-year monitoring period would provide a means of ensuring that reclamation success criteria are met and all post-closure systems are functioning properly in the event that such determinations cannot be made after 3 or 30 years, respectively. Conducting an evaluation of long-term risks of the post-closure conditions and reclamation requirements would inform the Forest Service of likely problem areas and inform the justification for requiring financial assurance to cover identified risks.

**Mitigation Measure MM-6: Pipeline and Power Line Operation, Inspection, and Reporting**

**Resource affected/impacts being mitigated:**

Proposed activities at Pinto Valley Mine include both new and reauthorized use of National Forest System lands for activities related to both pipelines and power lines, including potential construction or relocation of these linear features. Monitoring and inspection of these features are intended to identify, prevent, and detect potential issues (safety and environmental) before they pose risks, such as potential leaks, processes for containment of potential spills, and measures for preventing equipment failure or decline.

**Description of mitigation measure:**

Pinto Valley Mining Corp. will submit a plan that describes specific procedures for inspections, maintenance, reporting, incident actions, and emergency response protocols, and to provide for a documented program to monitor and address potential issues at all linear facilities including power lines and pipelines on National System Forest lands owned and managed by Pinto Valley Mining Corp. Maintenance and repair of the pipeline and electric lines could include but is not limited to excavation to expose the buried lines, repair of any broken or cut lines, and mowing the rights-of-way to clear the brush and grass. All



maintenance and repair equipment will remain within the authorized corridor unless a request is received and approved for additional area.

This measure would ensure inspections are a part of a routine monitoring program, good housekeeping, maintenance, line and corridor construction quality assurance/quality control, and any necessary repairs. Similar activities should occur at an increased frequency during and after considerable rainfall events.

**Measure timing:**

This measure would be implemented following the record of decision and would persist during operation and closure until the features are reclaimed.

**Source of measure:**

Developed by the Forest Service

**Applicable alternatives:**

Proposed action and alternative 1

**Authority to require:**

Authority is provided under 36 CFR 228.8 and 228.9.

**Additional ground disturbance or other impacts that could result from implementation of this mitigation measure:**

None.

**Effectiveness of the mitigation measure:**

This measure would ensure that linear features, such as pipelines and power lines, are inspected and maintained to minimize adverse impacts on National Forest System lands. Additionally, it would improve communication and understanding of these features while providing support for the final reclamation plan.

**Mitigation Measure MM-7: Forest Service Bond Requirements**

**Resource affected/impacts being mitigated:**

National Forest System surface resources (soil, vegetation) will be disturbed by the proposed operation and will require financial assurance to ensure they are reclaimed in accordance with regulation, policy, and the mining plan of operation.

**Description of mitigation measure:**

The Forest Service is authorized and will require Pinto Valley Mining Corp. to furnish a bond or other financial assurance for the mining plan of operations (36 CFR 228.13). The Forest Service has developed guidance (2004) for calculating the amount of financial assurance required for mining projects, and it must be developed or reviewed by a Certified Locatable Minerals Administrator. This guidance includes costs to remove structures, regrade and recontour the surface, replace soil, and revegetate the reclaimed land, and it accounts for costs for long-term monitoring and maintenance costs, if such were to be required to meet applicable laws and regulations.

**Measure timing:**

The bond will be posted prior to approval of the proposed mining plan of operation.

**Source of measure:**

Forest Service

**Applicable alternatives:**

Alternative 1 and proposed action

**Authority to require:**

Authority is provided under 36 CFR 228.13 and in compliance with form FS-2800-05.

**Additional ground disturbance or other impacts that could result from implementation of this mitigation measure:**

There would be no surface disturbance or other impacts associated with this measure.

**Effectiveness of the mitigation measure:**

In following the bond calculation guidance outlined in the 2004 Forest Service bonding guide, the agency will ensure sufficient funds are available for the agency to complete necessary reclamation work should Pinto Valley Mining Corp. not fulfill its requirements.

**Mitigation Measure MM-8: Mining Plan of Operations Expiration Date Extension**

**Resource affected/impacts being mitigated:**

The mining plan of operations expiration date may need to be extended due to continued operations, additional time required to address monitoring and mitigation requirements, additional time required to successfully complete reclamation, or other factors.

**Description of mitigation measure:**

The mining plan of operations will have a specified expiration date or term. If operations will need to continue beyond that date, a new or modified plan must be submitted to the Forest Service in accordance with 36 CFR part 228, subpart A.

**Measure timing:**

A date will be identified and included prior to the final approval of the mining plan of operations.

**Source of measure:**

Forest Service

**Applicable alternatives:**

Alternative 1 and proposed action

**Authority to require:**

Authority is provided under 36 CFR part 228, subpart A and in compliance with form FS-2800-05.

**Additional ground disturbance or other impacts that could result from implementation of this mitigation measure:**

There would be no surface disturbance or other impacts associated with this measure.

**Effectiveness of the mitigation measure:**

This measure will ensure the disclosed potential impacts occur as disclosed in the EIS and are not extended beyond the timeframe considered.

## 4.4.2 Air Quality

### Mitigation Measure AQ-1: Lower-Emitting Engines

**Resource affected/impacts being mitigated:**

Potential impacts on air quality (nitrogen oxides and particulate matter emissions) resulting from use of higher-emitting engines that are currently utilized at the Pinto Valley Mine.

**Description of mitigation measure:**

Even though there are no identified exceedances of National Ambient Air Quality Standards, at the end of the lifespan of the current haul trucks, hydraulic shovels, and track dozers, the Forest Service recommends that Pinto Valley Mining Corp. replace or retrofit these vehicles or engines with lower-emitting vehicles or engines that meet U.S. Environmental Protection Agency Tier 4 emissions standards or better.

**Measure timing:**

This measure would be implemented at the end of the lifespan of the current fleet of vehicles used at the Pinto Valley Mine.

**Source of measure:**

Developed by the Forest Service in coordination with the U.S. Environmental Protection Agency

**Applicable alternatives:**

Proposed action and alternative 1

**Authority to require:**

Authority exists under 36 CFR 228.8 and the Clean Air Act, as amended (42 U.S. Code 1857 et seq.). In addition, the Tonto National Forest Plan (Forest Service 1985) requires that activities be planned so that air quality will be equal to or better than that required by applicable Federal, State, and local standards or regulations.

**Additional ground disturbance or other impacts that could result from implementation of this mitigation measure:**

None.

**Effectiveness of the mitigation measure:**

Mitigation Measure AQ-1 would reduce emissions from haul trucks, hydraulic shovels, and track dozers by replacing older, higher-emitting engines with lower-emitting engines. The lower-emitting engines would be effective at reducing nitrogen oxides and particulate matter emissions.

### 4.4.3 Biological Resources (Vegetation, Fish and Wildlife, Special Status Species)

#### Mitigation Measure BR-1: Biological Resources Monitoring and Mitigation Plan

**Resource affected/impacts being mitigated:**

This plan addresses potential impacts on vegetation, wildlife, and special status species from surface disturbance, project-related water use, and potential effects on water quality and quantity that could affect vegetation, wildlife habitat, and special status species.

**Description of mitigation measure:**

The “Biological Resources Monitoring and Mitigation Plan” (see attachment A) outlines a program of monitoring, surveys, and potential mitigation and adaptive management to address the Endangered Species Act-listed threatened yellow-billed cuckoo (*Coccyzus americanus*) and its proposed critical habitat, the endangered Arizona hedgehog cactus (*Echinocereus triglochidiatus* var. *arizonicus*), noxious and invasive weeds, raptor nests, and other special status species that may occur within the biological analysis area. This plan identifies thresholds for these monitored ecosystem components and identifies possible mitigation actions that could be taken if these thresholds are exceeded. Refer to attachment A in this appendix for the complete “Biological Resources Monitoring and Mitigation Plan.”

Pinto Valley Mining Corp. would continue to consider monitoring, mitigation, and adaptive management strategies to address impacts on biological resources, including potential impacts from the post-closure pit lake.

**Measure timing:**

This plan would be implemented during active mining operations, closure, and post-closure of the mine.

**Source of measure:**

Developed by the Forest Service and Pinto Valley Mining Corp.

**Applicable alternatives:**

Proposed action and alternative 1

**Authority to require:**

Authority to protect threatened and endangered species and the ecosystems upon which they depend is granted by the Endangered Species Act of 1973 (16 U.S. Code 1531 et seq.), and section 7 of this act specifically requires Federal agencies to ensure actions undertaken do not jeopardize the continued existence of threatened and endangered species. Additionally, the Migratory Bird Treaty Act of 1918 (16 U.S. Code 703–712) and the Bald and Golden Eagle Protection Act (16 U.S. Code 668–668c) establish protection of migratory birds and bald and golden eagles. Furthermore, 36 CFR 228.8(e) indicates that an operator shall take all practicable measures to maintain and protect wildlife habitat that may be affected by operations. In addition, the Tonto National Forest Plan (Forest Service 1985) includes a management objective to prevent destruction or adverse modification of critical habitats for threatened and endangered species and manage for a goal of increasing population levels that will remove them from the lists.

**Additional ground disturbance or other impacts that could result from implementation of this mitigation measure:**

At this time, there are no specific restoration or relocation activities proposed that would result in additional surface disturbance or other impacts. However, should there be a need for restoration, relocation, or other adaptive management, certain actions such as upland habitat restoration for yellow-billed cuckoo, relocation of Arizona hedgehog, or relocation of active raptor nests could have additional effects on these target species and their habitats. In general, these activities would result in short-term effects on surface resources while the activities are occurring (such as from disturbance or noise); however, these activities would typically result in long-term beneficial effects on habitat and species. These actions would be subject to approval by the Forest Service and U.S. Fish and Wildlife Service and would be implemented in response to exceedance of thresholds identified in section 4 of the plan.

**Effectiveness of the mitigation measure:**

Mitigation Measure BR-1 will assist the Forest Service in determining if project-related effects on riparian vegetation and hydrology would affect yellow-billed cuckoo or its proposed critical habitat; if new project-related disturbance would affect Arizona hedgehog cactus; and if operation of the Pinto Valley Mine would affect the occurrence, abundance, or distribution of noxious and invasive weeds, raptors, or other special status species in the analysis area. If impacts are identified through surveys and monitoring, the plan identifies potential adaptive management approaches and mitigation measures that would be considered to reduce potential impacts.

**Mitigation Measure BR-2: Whole-Effluent Toxicity Testing**

**Resource affected/impacts being mitigated:**

Some monitoring wells immediately downgradient from Tailings Storage Facility No. 1/2, Tailings Storage Facility No. 3, and Tailings Storage Facility No. 4 exhibit high concentrations of total dissolved solids and sulfate that exceed the non-enforceable National Secondary Drinking Water Regulations. During the mining and post-mining periods, the high total dissolved solids and high sulfate leachate would continue to drain through the tailings and seep out of the base of the tailings storage facilities, entering the groundwater flow system. There is a potential for seepage to discharge as baseflow (and degrade water quality) in Pinto Creek, in particular, during the post-closure period after the Peak Well field pump system is shut down. Increased levels of total dissolved solids and sulfate in Pinto Creek could have adverse impacts on aquatic organisms including macroinvertebrates, fish, and plants.

**Description of mitigation measure:**

Pinto Valley Mining Corp. will contract with a qualified entity to conduct whole effluent toxicity testing in Pinto Creek at sites identified in Mitigation Measure WR-1 (Pinto Creek Below Haunted Canyon, U.S. Geological Survey station 09498501, and Pinto Creek near Miami, Arizona, U.S. Geological Survey station 09498502) to assess the aggregate toxic effects of surface water quality conditions in Pinto Creek on representative aquatic organisms at locations up- and downstream of Pinto Valley Mine. Whole effluent toxicity testing would be conducted during the first 2 years of monitoring under the "Comprehensive Water Resource Monitoring and Mitigation Plan," as defined in Mitigation Measure WR-1.

Whole effluent toxicity testing may also be required after the initial monitoring period if any of the following conditions are met:

1. The results of the initial whole effluent toxicity testing indicate adverse effects on water quality or aquatic organisms that are attributable to Pinto Valley Mine.
2. The Pinto Creek water quality monitoring program identified in the “Comprehensive Water Resource Monitoring and Mitigation Plan” (see attachment D) indicates increased levels of total dissolved solids and sulfate that are attributable to the Pinto Valley Mine during operations or the post-closure period.
3. Thresholds for total dissolved solids and sulfate are established by the Arizona Department of Environmental Quality that require additional whole effluent toxicity testing.

Site-specific methods for whole effluent toxicity testing will be consistent with U.S. Environmental Protection Agency methodology and agreed upon by the Forest Service and Pinto Valley Mining Corp. prior to conducting the whole effluent toxicity testing during the initial monitoring period. Updates to whole effluent toxicity testing methodology would be considered as needed. If whole effluent toxicity testing indicates adverse impacts attributable to the mine on aquatic species, additional adaptive management strategies would be developed by Pinto Valley Mining Corp. and the Forest Service, and then applied.

**Measure timing:**

Whole effluent toxicity testing would be conducted at the two locations twice during the initial monitoring period on the same schedule as under the “Comprehensive Water Resource Monitoring and Mitigation Plan” (attachment D): once during the summer wet season (June 1–October 31) and once during the winter wet season (November 1–May 31). Additional whole effluent toxicity testing may be required after the initial monitoring period based on the results of the initial testing or of water quality monitoring in Pinto Creek, or if thresholds for total dissolved solids and sulfate are established.

**Source of measure:**

Developed by the Forest Service

**Applicable alternatives:**

Proposed action and alternative 1

**Authority to require:**

Authority exists under 36 CFR 228.8(e), which indicates that the operator shall take all practicable measures to maintain and protect fisheries and wildlife habitat that may be affected by the operations. In addition, the Tonto National Forest Plan (Forest Service 1985) indicates that watersheds will be managed so as to improve them to a satisfactory or better condition. Operators shall improve and manage the included riparian areas (as defined by Forest Service Manual 2526) to “benefit riparian dependent resources.” The Tonto National Forest Plan also indicates: “Manage the warm water non-game type streams to support Gila sucker and longfin dace.”

**Additional ground disturbance or other impacts that could result from implementation of this mitigation measure:**

There would be no surface disturbance or other impacts associated with this measure.

**Effectiveness of the mitigation measure:**

Mitigation Measure BR-2 would provide a means to understand the aggregate potential toxic effects of water quality conditions on representative aquatic organisms during and after the initial monitoring period. If the results of the whole effluent toxicity testing or water quality testing indicate issues that are attributable to the mine, other adaptive management strategies could be developed and implemented to reduce impacts on water quality and aquatic organisms in Pinto Creek.

#### 4.4.4 Cultural Resources

##### Mitigation Measure CR-1: Historic Properties Treatment Plan

**Resource affected/impacts being mitigated:**

Potential adverse effects on 45 historic properties associated with surface disturbance and other project-related activity and potential impacts on undiscovered properties that may be affected by project-related activity.

**Description of mitigation measure:**

The historic properties treatment plan (WestLand Resources, Inc. 2019) developed for Pinto Valley Mining Corp.'s proposed action identifies specific protective measures and data recovery strategies that would be applied to minimize potential adverse effects on the identified historic properties. The historic properties treatment plan has been codified as part of the memorandum of agreement among the Forest Service, State Historic Preservation Office, Advisory Council on Historic Preservation, and Pinto Valley Mining Corp. The historic properties treatment plan describes conditions for 18 historic properties located within the direct area of potential effect where topographic settings will provide protection. The plan provides for protective measures (signs and barriers) to be used at 13 other properties that could be affected. The plan also identifies another 14 historic properties proposed for data recovery prior to any project activities that could affect these sites. One of the identified properties will be treated with both protective measures and partial data recovery. The plan also includes a discovery plan that describes the specifies procedures for evaluating and treating inadvertent discoveries of cultural resources that may occur during construction, operation, maintenance, decommissioning, or reclamation activities including inadvertent discoveries of artifacts, artifact scatters, features, and archaeological sites, as well as human remains, funerary objects, sacred objects, and objects of cultural patrimony.

**Measure timing:**

This plan would be implemented whenever there are potential adverse effects on identified historic properties.

**Source of measure:**

Developed by the Forest Service, Pinto Valley Mining Corp., Arizona State Historic Preservation Office, and Advisory Council on Historic Preservation

**Applicable alternatives:**

Proposed action. The current memorandum of agreement and historic properties treatment plan would be updated if alternative 1 is selected.

**Authority to require:**

The authority to require this mitigation measure is derived from the National Historic Preservation Act of 1966 (Public Law 89 665; 54 U.S. Code Section 300101 et seq.). Section 106 of the act requires Federal agencies to take into account the effects of the undertaking on any entity included in or eligible for inclusion in the National Register of Historic Places, and to consult with tribes to determine if there are historic properties of tribal interest that may be adversely affected by the undertaking. Additional Federal laws granting authority to require this mitigation measure are the Archaeological Resources Protection Act of 1979 (16 U.S. Code Section 470aa–470mm); Native American Graves Protection and Repatriation Act of 1990 (23 U.S. Code 3001 et seq.); American Indian Religious Freedom Act of 1978 (42 U.S. Code 1996–1996a); American Antiquities Act of 1906 (6 U.S. Code 431–433); 25 U.S. Code 32A; Executive Order 13175: Consultation and Coordination with Indian Tribal Governments; and Executive Order 13007: Indian Sacred Sites. Various Forest Service regulations, policies, and guidance and Arizona State laws provide further guidance to carry out these requirements. In addition, the Tonto National Forest Plan (Forest Service 1985) indicates that for all surface-disturbing activities, the Forest Service will comply with the National Historic Preservation Act and that the preferred management of sites eligible for the National Register of Historic Places is to avoid and protect the historic sites.

**Additional ground disturbance or other impacts that could result from implementation of this mitigation measure:**

In accordance with the historic properties treatment plan, there are 14 historic properties that would be subject to data recovery efforts. Data recovery for historic properties would generally consist of a variety of tasks that could result in human activity, surface use, and minor levels of disturbance including reconnaissance and documentation, surface artifact collections, archaeological testing, feature excavation, exploration of extramural areas, and post-excavation stripping. Reconnaissance and documentation, surface artifact collection, and archaeological testing are not anticipated to result in any impacts on resources on National Forest System lands, as there is no excavation associated with these tasks. Feature excavation, exploration of extramural areas, and post-excavation stripping would generally employ hand and mechanical excavation of relatively small areas associated with the property (such as 2-meter by 2-meter or 4-meter by 4-meter grids with hand excavation up to approximately 20 centimeters deep). Due to the relatively minimal amount of expected excavation area, the localized nature of the hand excavation areas, and the limited duration of these activities, there are no anticipated impacts on surface resources on National Forest System lands.

In accordance with the historic properties treatment plan, there are 14 historic properties that would be subject to protective measures (including protective measures at a site that will also receive partial data recovery). Protective measures for historic properties would generally consist of the installation of boulder barriers, protective signage, construction monitoring, and annual review of the effectiveness of the protective measures. In general, construction monitoring and annual review of the effectiveness of the protective measures are not anticipated to result in impacts on surface resources on National Forest System lands. Boulders used as barriers would be a minimum of 3 feet in diameter and would be obtained off site, and protective signage would generally involve installation of signs with estimated footings of up to 1 foot by 1 foot installed along roadways. Boulder barriers and protective signs may result in minor localized surface disturbance where the boulders are placed or the signs are installed. Due to the relatively limited size of the boulders and signs and the



localized nature of their placement, there are no anticipated impacts on resources on National Forest System lands. In general, boulders or signs placed along National Forest System roads would be installed outside the main road surface or on pullouts from the main road surface. As such, there are no anticipated impacts on access to or use of National Forest System roads by the general public due to these protective measures besides the intended effect of limiting access to the identified historic properties.

**Effectiveness of the mitigation measure:**

Implementation of the approved mitigation measures in the historic properties treatment plan reduce potential impacts on historic properties and would ensure that important information that could be gained from identified historic properties would be recovered prior to disturbance. Adherence to these requirements would be enforced through the memorandum of agreement. The historic properties treatment plan includes provisions to monitor and evaluate the effectiveness of mitigations applied to historic properties, which would vary based on the specific treatments applied. In addition, the historic properties treatment plan contains a monitoring and discovery plan that will determine if residual effects on historic properties would occur. This discovery plan specifies procedures for evaluating and treating discoveries of cultural resources that may occur during construction, operation, maintenance, decommissioning, or reclamation activities associated with the undertaking after the implementation of the historic properties treatment plan. Data recovery can reduce adverse effects by sampling historic properties that are eligible for their scientific information potential under Criterion D of the National Register of Historic Places. However, there are several limitations to data recovery's effectiveness. Data recovery can record and preserve some of the materials from the sites, but it cannot preserve the current integrity of setting, association, workmanship, feeling, location, and design.

#### 4.4.5 Tribal Resources of Concern

##### Mitigation Measure TR-1: Tribal Monitors

**Resource affected/impacts being mitigated:**

Potential impacts on historic properties that are of concern to tribes.

**Description of mitigation measure:**

As part of the memorandum of agreement, tribal monitors would be invited to participate in the data recovery phase of the historic properties treatment plan.

**Measure timing:**

This measure would be implemented whenever there are data recovery efforts for identified historic properties.

**Source of measure:**

Developed by the Forest Service with input from tribes

**Applicable alternatives:**

Proposed action and alternative 1

**Authority to require:**

This mitigation measure is the result of tribal consultation for the project in accordance with the National Historic Preservation Act of 1966 (Public Law 89 665; 54 U.S. Code section 300101 et seq.) and Executive Order 13175: Consultation and Coordination with Indian Tribal Governments.

**Additional ground disturbance or other impacts that could result from implementation of this mitigation measure:**

Refer to mitigation measure CR-1 for a description of data recovery activities and potential effects.

**Effectiveness of the mitigation measure:**

This mitigation measure would ensure that data recovery efforts under the historic properties treatment plan are conducted in a manner respectful to the tribes.

## 4.4.6 Fire and Fuels Management

### Mitigation Measure FF-1: Fire Plan

**Resource affected/impacts being mitigated:**

Potential for unplanned wildfire ignitions from Pinto Valley Mining Corp.'s activities on and adjacent to National Forest System lands during operations, closure, and post-closure and documentation of measures to avoid and respond to fires if they occur.

**Description of mitigation measure:**

As part of the mining plan of operations approval, Pinto Valley Mining Corp. will prepare a fire plan for the project. The main components of the fire plan would include but not be limited to identification of applicable fire restrictions, measures taken to reduce the potential for unplanned ignitions, fire response activities, water supply for fire response, and a description of how Pinto Valley Mining Corp. will coordinate with Federal, State, and local entities on fires and fire response. The fire plan would also include annual meetings between Pinto Valley Mining Corp. and the Forest Service to confirm fire response strategies and protocols for each season. As part of these annual fire meetings, Pinto Valley Mining Corp. and the Forest Service will coordinate and assess adequacy and clarity of signage (for emergency response and public information) following construction, realignment, or maintenance on roads, in the mine operations area.

**Measure timing:**

This plan would be implemented following the record of decision and would persist during operations, closure, and post-closure.

**Source of measure:**

Developed by the Forest Service and Pinto Valley Mining Corp.

**Applicable alternatives:**

Proposed action and alternative 1

**Authority to require:**

Authority is provided under 36 CFR 228, subpart A (§228.11). In addition, authority exists under the Federal Wildland Fire Management Policy of 1995, which provides direction for consistent implementation of the Federal fire policy. Additional authority is provided under Executive Order 13855, which promotes active management of America's forests to improve conditions and reduce wildfire risk. In addition, Arizona Revised Statute title 37-623.02(F) provides that the Forest Service should coordinate with appropriate entities (such as operators and State and local agencies) to ensure prevention and suppression of wildfires.

**Additional ground disturbance or other impacts that could result from implementation of this mitigation measure:**

The fire plan may identify additional measures that could be taken to reduce the potential for unplanned ignitions and additional fire response activities that may result in additional ground disturbance. For example, the fire plan may identify additional vegetation clearing or treatments that could provide fire breaks in the event of unplanned ignitions. In general, these activities would be implemented on an as-needed basis and additional permitting or National Environmental Policy Act review would be conducted at the time the specific activities are proposed, if required.

**Effectiveness of the mitigation measure:**

This measure would document measures that Pinto Valley Mining Corp. would take to reduce the potential for unplanned ignitions and would enhance planning and coordination among Pinto Valley Mining Corp., the Forest Service, and emergency responders in response to fire, reducing the potential for loss of life and property.

## 4.4.7 Geology, Minerals, and Geotechnical Stability

### Mitigation Measure GM-1: Open Pit Wall Stability and Mitigation Plan

**Resource affected/impacts being mitigated:**

There are potential impacts on and from instability of the Open Pit during operation, closure, and post-closure of the Pinto Valley Mine. Depending on the geotechnical conditions in the Open Pit at the time of mine closure, there may be a risk of progressive failure of the pit wall, especially during the post-closure period. A progressive failure could result in the formation of tension cracks and slope creep on National Forest System lands located outside of the planned pit perimeter. Impacts from pit instability could include threats to public health and safety and to mine workers, loss of National Forest System lands for post-mine land use, and long-term maintenance liabilities.

**Description of mitigation measure:**

The "Open Pit Wall Stability and Mitigation Plan" (see attachment B) identifies actions that Pinto Valley Mining Corp. will conduct to monitor the Pinto Valley Mine Open Pit walls adjoining National Forest System lands and mitigate stability issues during the operations and the post-closure periods. The plan identifies practices and procedures that Pinto Valley Mining Corp. would continue to apply to mitigate the potential for slope creep and failures within the Open Pit during operations and mitigation measures that would be applied post-closure. The plan also identifies adaptive management practices that would be applied based on the results of pit wall monitoring and inspection. Refer to attachment B in this appendix for the complete "Open Pit Wall Stability and Mitigation Plan."

**Measure timing:**

The “Open Pit Wall Stability and Mitigation Plan” would be applied during the operations, closure, and post closure periods.

**Source of measure:**

Developed by the Forest Service and Pinto Valley Mining Corp.

**Applicable alternatives:**

Proposed action and alternative 1

**Authority to require:**

Authority is provided under 36 CFR 228, subpart A, which indicates that operators should maintain all structures to protect the public in accordance with Federal and State laws and regulations (§228.9) and that all operations shall be conducted to minimize adverse environmental impacts on national forest surface resources (§228.8).

**Additional ground disturbance or other impacts that could result from implementation of this mitigation measure:**

The estimates of existing disturbance for the alternatives in chapter 2, “Proposed Action and Alternatives,” of the EIS and in the disclosure of environmental consequences in chapter 3, “Affected Environment and Environmental Consequences,” of the EIS account for surface disturbance associated with current instability issues and the expected extent of the Open Pit. The Forest Service does not anticipate any additional surface disturbance or impacts associated with this plan.

**Effectiveness of the mitigation measure:**

Implementation of the plan is expected to minimize potential impacts associated with slope failures and encroachment onto National Forest System lands outside of permitted limits during the mining and post-mining periods. Annual updates to the plan would ensure that the monitoring and mitigations are adapted to changing conditions.

**Mitigation Measure GM-2: Post-Closure Storm Water Control, Inspection, and Maintenance Plan for Tailings Storage Facilities on National Forest System Land**

**Resource affected/impacts being mitigated:**

During the last 10 years of active mining, Tailings Storage Facility No. 4 will be modified by construction of internal benches and berms on top of the facility to create three separate cells for storage of tailings, process water, and storm water. Tailings will be deposited behind the benches to create an approximately flat tailings surface. Berms will be constructed on top of the benches to provide freeboard for storing storm water. The total storage capacity within the three cells, behind the berms, is sufficient to store storm water volumes resulting from the probable maximum flood event from the contributing watersheds to each cell. A potential issue is that if these cell berms are not removed following the 10-year post-closure period, there is a potential for storm water to be stored behind the berms during flood events larger than a 500-year flood. During any major flood event larger than a 500-year storm, it is likely that the east channel spillway armoring will suffer damage. Head cutting along the unprotected steep channel section during the event could breach the east side of the berm, releasing the stored water as a flood wave and mobilizing impounded tailing materials.

Additionally, the Cottonwood Tailings Impoundment is on National Forest System lands and is subjected to storm water events that could affect the existing closure design of this facility.

**Description of mitigation measure:**

The “Post-Closure Stormwater Control, Inspection, and Maintenance Plan” (see attachment C) developed for Pinto Valley Mining Corp.’s proposed action establishes inspection and maintenance protocols for the storm water management facilities at Tailing Storage Facilities No. 3 and No. 4 following cessation of mining and after reclamation. The plan describes the post-closure storm water control plan for Tailings Storage Facilities No. 3 and No. 4; describes the operation, maintenance, and surveillance components of the post-closure storm water control plan; identifies triggers for maintenance and mitigation for post-closure storm water controls; and describes reporting requirements for the post-closure storm water controls. Refer to attachment C in this appendix for the complete “Post-Closure Stormwater Control, Inspection, and Maintenance Plan.” Pinto Valley Mining Corp. will also update the plan to include appropriate storm water control measures, inspection procedures, and potential maintenance activities for the existing Cottonwood Tailings Impoundment on National Forest System lands.

**Measure timing:**

This measure would be applied during the post-closure period, which is currently assumed to last approximately 30 years. A 30-year post-closure monitoring and maintenance period was selected based on an expectation that reclaimed facilities will reach a stable condition and vegetation will have matured to a natural-looking community within 30 years. If facilities are determined to not be stable at the end of the 30-year post-closure period, additional monitoring and mitigation may be required.

**Source of measure:**

Developed by the Forest Service and Pinto Valley Mining Corp.

**Applicable alternatives:**

Proposed action and alternative 1

**Authority to require:**

Authority is provided under 36 CFR 228, subpart A, which indicates that operators should maintain all structures to protect the public in accordance with Federal and State laws and regulations (§228.9) and that all operations shall be conducted to minimize adverse environmental impacts on national forest surface resources (§228.8).

**Additional ground disturbance or other impacts that could result from implementation of this mitigation measure:**

Ongoing maintenance of storm water management facilities is not anticipated to result in additional surface disturbance outside of those areas considered under the alternatives analysis. These maintenance activities are accounted for in the estimated disturbance calculations presented under the alternatives in chapter 2, “Proposed Action and Alternatives,” of the EIS and potential impacts are disclosed in chapter 3, “Affected Environment and Environmental Consequences,” of the EIS. The Forest Service does not anticipate any further impacts associated with this mitigation measure unless there are departures from planned maintenance activities described in the plan.

**Effectiveness of the mitigation measure:**

A documented program for the operation, maintenance, and surveillance of post-closure storm water controls would reduce the potential for geotechnical instability issues at the tailings storage facilities associated with storm water management during the post-closure period. This measure would also ensure that any changes to the post-closure storm water management strategies and plans are communicated to the Forest Service. In particular, Pinto Valley Mining Corp. would demonstrate that any changes would not allow for impoundment of flood waters at Tailings Storage Facility No. 4, which would reduce risk of downstream flooding due to potential breach and release of impounded water in the event of storm events that exceed the design hydrologic events for the storm water conveyance facilities.

**Mitigation Measure GM-3: Post-Closure Grading for Tailings Storage Facilities on National Forest System Land**

**Resource affected/impacts being mitigated:**

Improper grading could result in retention of storm water and other fluids in the tailings storage facilities, increasing the potential for geotechnical instabilities. Geotechnical instabilities would increase the risk of downstream flooding and contamination of National Forest System lands due to potential breach and release of impounded water during storm events that exceed the design hydrologic events for the storm water conveyance facilities.

**Description of mitigation measure:**

Prior to commencement of final closure activities at either Tailings Storage Facility No. 3 or Tailings Storage Facility No. 4, and whenever changes are made to the post-closure storm water management strategies and plans already submitted, Pinto Valley Mining Corp. will provide the Forest Service with copies of the updated strategies and plans containing details on how these updates maintain consistency with the closure strategy of not retaining fluids in the facilities and ensuring stable slopes. In addition, Pinto Valley Mining Corp. would conduct appropriate maintenance and grading activities on the Cottonwood Tailings Impoundment to ensure proper surface runoff from the facility.

**Measure timing:**

This measure would be applied when facilities enter the post-closure phase.

**Source of measure:**

Developed by the Forest Service

**Applicable alternatives:**

Proposed action and alternative 1

**Authority to require:**

Authority is provided under 36 CFR 228, subpart A, which indicates that operators should maintain all structures to protect the public in accordance with Federal and State laws and regulations (§228.9) and that all operations shall be conducted to minimize adverse environmental impacts on national forest surface resources (§228.8).

**Additional ground disturbance or other impacts that could result from implementation of this mitigation measure:**

Surface disturbance and other project-related activity associated with post-closure grading is accounted for in the estimated disturbance calculations presented under the alternatives in chapter 2, “Proposed Action and Alternatives,” of the EIS and potential impacts are disclosed in chapter 3, “Affected Environment and Environmental Consequences,” of the EIS. The Forest Service does not anticipate any further impacts associated with this mitigation measure.

**Effectiveness of the mitigation measure:**

This mitigation measure would provide a mechanism for Pinto Valley Mining Corp. to coordinate with the Forest Service to ensure that grading, reclamation, storm water management, and other activities are consistent with closure strategy objectives and support the long-term stability of the tailings storage facilities on National Forest System lands during post-closure, and would minimize the potential for impoundment of flood waters.

## **4.4.8 Livestock Grazing**

### **Mitigation Measure LG-1: Livestock Grazing Fencing**

**Resource affected/impacts being mitigated:**

Proposed activities at Pinto Valley Mine could result in removal of existing fencing or create need for additional fencing to manage livestock grazing in the Pinto Creek and Sleeping Beauty allotments administered by the Forest Service.

**Description of mitigation measure:**

If Pinto Valley Mine-related activities damage or destroy livestock grazing fences, Pinto Valley Mining Corp. would promptly notify the Forest Service and would be responsible for promptly repairing or replacing livestock grazing fencing on National Forest System lands to control livestock movement and access.

**Measure timing:**

This measure would be implemented following the record of decision and would persist during operation and closure.

**Source of measure:**

Developed by the Forest Service and Pinto Valley Mining Corp.

**Applicable alternatives:**

Proposed action and alternative 1

**Authority to require:**

Authority for this measure and for regulating and improving rangelands for grazing on public lands is granted by the Taylor Grazing Act of 1934, as amended, 43 U.S. Code 315 et seq. Authority also exists under 36 CFR 222, Grazing and Livestock Use on National Forest System Lands, which indicates that the Forest Service administers and protects range resources and permits the grazing use of all kinds and classes of livestock on National Forest System lands.

**Additional ground disturbance or other impacts that could result from implementation of this mitigation measure:**

Repairing and replacing livestock grazing fencing could result in localized and minor levels of surface disturbance due to installing fence footings and fence posts. However, this disturbance would typically be located in existing alignments and existing disturbance areas for fencing. Due to the minimal amount of surface disturbance and the localized nature of fence repair and replacement, impacts are expected to be negligible.

**Effectiveness of the mitigation measure:**

This measure would ensure that fences are maintained to prevent livestock from moving into areas not authorized for grazing or areas that may present injury or entrapment hazards. This measure would also ensure that grazing permit authorizations are not interfered with due to damage or destruction of fences from activities associated with the Pinto Valley Mine.

## 4.4.9 Public Health and Safety

### Mitigation Measure PH-1: Health and Safety Plan

**Resource affected/impacts being mitigated:**

Potential impacts on the health and safety of the general public and other resources (such as wildlife) from project-related facilities and the use, storage, and transport of hazardous and nonhazardous materials at the Pinto Valley Mine on National Forest System lands.

**Description of mitigation measure:**

As part of the mining plan of operations approval, Pinto Valley Mining Corp. will prepare a health and safety plan (or a series of plans for each component) for activities on National Forest System lands including the use, transport, and storage of hazardous materials and explosives. The main components of the health and safety plan would include, but not be limited to: identification of applicable regulatory standards and requirements; description of how hazardous and nonhazardous materials are managed during operations, closure, and post-closure; identification of hazardous and nonhazardous materials that are transported, used, and stored on National Forest System lands; and a description of activities and procedures for reducing public health and safety hazards from project activities and facilities during the operation, closure, and post-closure periods (such as blasting, fencing around the open pit, and access limitations). The plan would describe fencing and other enclosures during operations, closure, and post-closure to ensure that a perimeter security fence will be installed at a sufficient distance from the rim of the Open Pit to prevent unintentional public access.

**Measure timing:**

This plan would be implemented following the record of decision and would persist during operation, closure, and post-closure.

**Source of measure:**

Developed by the Forest Service and Pinto Valley Mining Corp.

**Applicable alternatives:**

Proposed action and alternative 1



**Authority to require:**

Authority to require this mitigation measure is granted by 36 CFR part 228, subpart A, which sets forth rules and procedures for maintaining public health and safety associated with locatable mineral operations on National Forest System lands. Authority also exists under the Resource Conservation and Recovery Act of 1976, the Hazardous Materials Transportation Act of 1975, and 40 CFR 112 due to the use, storage, and transport of hazardous materials at the Pinto Valley Mine. Authority also exists under Arizona Hazardous Waste Management (Arizona Revised Statute 49-921–932) and Pollution Prevention (Arizona Revised Statute 49-961–969) laws.

**Additional ground disturbance or other impacts that could result from implementation of this mitigation measure:**

There would be no surface disturbance or other impacts associated with this measure.

**Effectiveness of the mitigation measure:**

Development and application of a health and safety plan for National Forest System lands would reduce potential physical public health and safety risks posed by mine features during operations, closure, and post-closure. The plan would reduce the potential for exposure to or inadvertent release of hazardous and nonhazardous materials that could have adverse effects on human health and the environment. Additionally, the hazardous and nonhazardous material safety program would ensure that protocols are in place to respond to, contain, and remediate material spills or releases if they occur on or would affect National Forest System lands.

## 4.4.10 Soils

### Mitigation Measure SR-1: Soil Characterization and Salvage

**Resource affected/impacts being mitigated:**

Existing and proposed surface disturbance and associated impacts on soils including the long-term productivity of soils and vegetation on National Forest System lands.

**Description of mitigation measure:**

Where feasible and practical, Pinto Valley Mining Corp. will salvage and stockpile growth media removed during excavation on National Forest System lands to be used in reclamation. This includes the need to develop best management practices for storing salvaged material, such as to store stockpiled topsoil separately from other vegetative slash or soil and rock materials and protect from wind and water erosion, unnecessary compaction, and contaminants. Additionally, Pinto Valley Mining Corp. would maintain its Noxious Weed Control Plan and apply other suitable measures, in compliance with local direction, to prevent and control invasive species and noxious weeds. The details of soil characterization and salvage will be included in the reclamation plan for National Forest System lands; see mitigation measure MM-4.

**Measure timing:**

This measure would be applied during periods of new soil disturbance on National Forest System lands during operations, closure, and the post-closure period.

**Source of measure:**

Developed by the Forest Service

**Applicable alternatives:**

Proposed action and alternative 1

**Authority to require:**

Authority is provided under 36 CFR 228, subpart A, which indicates that all operations shall be conducted so as, where feasible, to minimize adverse environmental impacts on national forest surface resources (§228.8) and that an operator shall reclaim the surface disturbed in operations by taking such measures as will prevent or control on-site and off-site damage to the environment and forest surface resources (§228.8(g)).

**Additional ground disturbance or other impacts that could result from implementation of this mitigation measure:**

There would be surface disturbance associated with certain reclamation activities such as grading, stockpiling and salvaging soils, and extracting soils for sources of borrow and riprap during reclamation. Surface disturbance associated with reclamation activities is accounted for in the surface disturbance estimates in chapter 2, "Proposed Action and Alternatives," of the EIS and within the impacts disclosure in chapter 3, "Affected Environment and Environmental Consequences," of the EIS.

**Effectiveness of the mitigation measure:**

This measure would require Pinto Valley Mining Corp. to salvage growth material to help meet measurable performance standards for revegetation, stability, post-mining land configuration, and other reclamation outcomes. This will also increase the potential for success of the reclamation plan that could have beneficial effects on a range of resources by reestablishing native vegetation communities and wildlife habitat, and planning for post-closure land uses.

## 4.4.11 Traffic and Transportation

### Mitigation Measure TR-1: Road Use Permit for National Forest System Road 287

**Resource affected/impacts being mitigated:**

Continued use of and potential impacts on National Forest System Road 287 resulting from authorized access to Pinto Valley Mine. The proposed use would require commercial hauling and ongoing maintenance necessary to meet assigned maintenance levels for public and administrative access.

**Description of mitigation measure:**

The Forest Service will issue Pinto Valley Mining Corp. a road use permit (FS-7700-41) containing the relevant terms and conditions for Pinto Valley Mining Corp.'s commercial use and maintenance of the paved portion of National Forest System Road 287.

On an annual basis, Pinto Valley Mining Corp. and the Forest Service will meet to discuss and, if needed, update the road use permit for all permitted maintenance and commercial uses of the paved portion of National Forest System Road 287 including road conditions, safety, and signage and will work together to identify and address any issues. If Pinto Valley Mining Corp.

elects to perform or contract for the performance of any reconstruction, improvements, or replacement of the paved portion of National Forest System Road 287, with Forest Service authorization via the road use permit, Pinto Valley Mining Corp. improvements will meet all applicable standards and guidelines for roadway and roadside including those for signs, guardrail, shoulders, vegetation, cattle guards, striping, and surface, among others.

**Measure timing:**

The measure would be implemented during operation, closure, and post-closure.

**Source of measure:**

Developed by the Forest Service and Pinto Valley Mining Corp.

**Applicable alternatives:**

Proposed action and alternative 1

**Authority to require:**

Authority is provided under 36 CFR 228 subpart A, Forest Service Manual 7730, "Transportation System Operation and Maintenance," and Forest Service Handbook 7709.59, "Road System Operations and Maintenance Handbook," chapter 20, "Traffic Management." Authority is also provided under Forest Service Manual 2813.25, which indicates that commercial hauling on existing roads requires a road use permit.

**Additional ground disturbance or other impacts that could result from implementation of this mitigation measure:**

There would be no surface disturbance or other impacts associated with this measure.

**Effectiveness of the mitigation measure:**

The road use permit will identify proposed commercial use and maintenance activities on National Forest System Road 287 to ensure compliance with Forest Service Manual 7730 by requiring Pinto Valley Mining Corp. be responsible for the maintenance costs associated with its commercial road use and impacts from the proposed action.

**Mitigation Measure TR-2: Rerouting or Realignment of National Forest System Road 287**

**Resource affected/impacts being mitigated:**

Rerouting and realignment of National Forest System Road 287 could affect agency needs, public safety, and emergency response access.

**Description of mitigation measure:**

Potential rerouting or realignment of segments of National Forest System Road 287 located on Pinto Valley Mining Corp.'s private land during proposed project operations will be coordinated with the Forest Service to ensure appropriate signage, gates and fencing, and other mechanisms to ensure clear and appropriate access for fire response, recreation, and other public uses. Additionally, Pinto Valley Mining Corp. will maintain public access to National Forest System Road 287 across Pinto Valley Mining Corp.'s private lands in accordance with the Forest Service's easement. The Forest Service requests that Pinto Valley Mining Corp. coordinate with the Forest Service on any realignments of National Forest System Road 287. The Forest Service also recommends that the Forest Service and Pinto Valley Mining Corp. pursue reciprocal easements for National Forest System Road 287 and other National Forest System roads crossing private property.

**Measure timing:**

This measure would be implemented during operation, closure, and post-closure.

**Source of measure:**

Developed by the Forest Service and Pinto Valley Mining Corp.

**Applicable alternatives:**

Proposed action and alternative 1

**Authority to require:**

Authority for Forest Service involvement in rerouting and realignment of National Forest System Road 287 on private land is provided based on the land patent and Forest Service easement for National Forest System Road 287 on private land (United States of America 1972).

**Additional ground disturbance or other impacts that could result from implementation of this mitigation measure:**

Under Mitigation Measure TR-2, rerouting or realignment of National Forest System Road 287 could result in surface disturbance and associated effects on resources (such as vegetation removal, habitat degradation, increased potential for soil erosion, and increased potential for spread and establishment of noxious weeds). The amount of surface disturbance and associated effects would depend on the location and overall mileage and disturbance area associated with potential reroutes or realignments of the road. In general, the estimated disturbance area would include the linear distance of the road reroute or realignment and an assumed road disturbance width of 25 feet. At this time, there are no specific reroutes or realignments proposed. This mitigation measure would ensure that Pinto Valley Mining Corp. coordinates with the Forest Service to identify an alignment for road reroutes or realignments that minimize potential impacts on surface resources on adjacent National Forest System lands. In general, potential impacts on surface resources from any future rerouting or realignment of National Forest System Road 287 are expected to be minimal based on the localized nature of potential reroutes of National Forest System Road 287, the limited amounts of surface disturbance, and requirements in accordance with existing easements.

In addition, rerouting or realignment of National Forest System Road 287 could result in minor delays to public users or other road users. However, there would be no anticipated closure of existing roads that would limit access. Also, as described in this mitigation measure, Pinto Valley Mining Corp. and the Forest Service would coordinate to ensure that appropriate signage, gates and fencing, and other mechanisms are in place to allow for continued access for fire response, recreation, and other public uses during any rerouting or realignment of National Forest System Road 287. As such, impacts on access along National Forest System Road 287 during reroutes or realignments are expected to be minimal.

**Effectiveness of the mitigation measure:**

This measure confirms rights in the existing easement, which relate to public access for fire response, recreation, and public use if rerouting or realignment of National Forest System Road 287 occurs on private land. This measure would also reduce any potential impacts on access during rerouting or realignment of National Forest System Road 287.

### **Mitigation Measure TR-3: Post-Closure Road Status and Reclamation**

**Resource affected/impacts being mitigated:**

Potential impacts on the long-term use, condition, and closure status of all National Forest System roads used by Pinto Valley Mining Corp.

**Description of mitigation measure:**

As a part of the reclamation plan for National Forest System lands (described in Mitigation Measure MM-4), Pinto Valley Mining Corp. will include a description of the final road status, timing for end of use, and any other details necessary for the reclamation all roads (National Forest System roads and access roads) that are proposed and authorized for use on National Forest System lands.

In regard to designated National Forest System roads, final road condition status will be in accordance with the Tonto National Forest Travel Management Plan at the time of completion of reclamation, which includes the paved portion of National Forest System Road 287 on National Forest System lands from the private parcel to the intersection with U.S. Highway 60. During closure and post-closure planning, Pinto Valley Mining Corp. will propose a final reclamation action and condition of the paved portion of National Forest System Road 287 from the private parcel to the intersection with U.S. Highway 60, subject to final approval by the Forest Service.

For all access roads on National Forest System lands, Pinto Valley Mining Corp. will be required to fully reclaim the roads when no longer necessary for mining and reclamation operations. The reclamation plan should include recontouring to pre-disturbance conditions to promote drainage and mimic natural topography, covering with rock armor or growth media, and revegetating with a native seed mix or plantings. Storm water best management practices such as water bars, culverts, and erosion-control features would also be removed as necessary and as specified by the Forest Service.

**Measure timing:**

This measure would be implemented as roads are no longer needed for operations, likely during the closure and post-closure periods.

**Source of measure:**

Developed by the Forest Service and Pinto Valley Mining Corp.

**Applicable alternatives:**

Proposed action and alternative 1

**Authority to require:**

Authority is provided under 36 CFR 228, subpart A, which states that operators shall reclaim the surface disturbed in operations by taking such measures as will prevent or control on-site and off-site damage to the environment and forest surface resources (§228.8(g)). Additional authority is provided under Forest Service Manual 7730, "Transportation System Operation and Maintenance," and Forest Service Handbook 7709.59, "Road System Operations and Maintenance Handbook."

**Additional ground disturbance or other impacts that could result from implementation of this mitigation measure:**

Reclamation activities associated with roads could result in surface disturbance due to recontouring, grading, extraction or movement of borrow and riprap, and removal of culverts and other features in or along the roadbed. In general, this disturbance would occur in areas that were previously disturbed, and the disturbance is accounted for within the average 25-foot-wide disturbance area for roads presented in chapter 2, "Proposed Action and Alternatives," of the EIS. In addition, potential sources of borrow and riprap for roads are accounted for in the surface disturbance estimates in chapter 2, "Proposed Action and Alternatives." In general, surface disturbance associated with reclamation activities would support an overall improvement in surface resource conditions and would eventually support meeting reclamation objectives and post-mining land uses.

In addition to surface disturbance, reclamation would result in emissions, noise, and other impacts while the reclamation activities are occurring. In general, project-related activity associated with reclamation activities is described in the disclosure of impacts in chapter 3, "Affected Environment and Environmental Consequences," of the EIS and the Forest Service does not anticipate further impacts.

**Effectiveness of the mitigation measure:**

This measure will ensure that final reclamation and post-closure conditions of all roads on National Forest System lands used by Pinto Valley Mining Corp. will meet Forest Service objectives for the road to ensure continued public use that is safe along with environmental conditions that are appropriate for overall Forest Service management and target uses following mine closure.

**Mitigation Measure TR-4: Restricted Access on National Forest System Roads**

**Resource affected/impacts being mitigated:**

There are existing gates on National Forest System roads restricting public access to the Pinto Valley Mine and the Open Pit. It is important to ensure gates are installed and maintained in a safe and functioning manner, thus ensuring public safety throughout the duration of current operation, closure, and, if needed, during the post-closure period.

**Description of mitigation measure:**

Pinto Valley Mining Corp. will be required to maintain the currently installed gates on National Forest System roads that are proposed for use during operation, closure, and, if needed, during the post-closure period. The gates will be secured with multiple locks to provide access for both Pinto Valley Mining Corp. and the Forest Service. Additionally, restricting access requires installation and maintenance of Forest Service-approved signage to inform the public of potential danger (EM-7100-15, 2013). When/if replacement of a gate or sign is needed, installation and maintenance shall be coordinated with the Forest Service to meet Forest Service standards (Forest Service Handbook 7709.59, chapter 20, section 25). Final closure methods will be agreed upon at the time of closure to ensure compliance with the Travel Management Plan.

Additionally, Pinto Valley Mining Corp. will continue to coordinate with the Forest Service to ensure public closure orders are in effect for appropriate areas on National Forest System lands.

**Measure timing:**

This plan would be implemented following the record of decision and would persist during operation, closure, and the post-closure period.

**Source of measure:**

Developed by the Forest Service

**Applicable alternatives:**

Alternative 1 and proposed action

**Authority to require:**

Authority is provided under 36 CFR 228.8(f).

**Additional ground disturbance or other impacts that could result from implementation of this mitigation measure:**

None.

**Effectiveness of the mitigation measure:**

This measure ensures compliance with Forest Service standards when restricting access due to public safety.

## 4.4.12 Water Resources and Hydrogeochemistry

### Mitigation Measure WR-1: Comprehensive Water Resource Monitoring and Mitigation Plan

**Resource affected/impacts being mitigated:**

Mine-related drawdown and potential contamination of water resources from mine-related facilities could affect groundwater and surface water quantity and quality.

**Description of mitigation measure:**

The “Comprehensive Water Resource Monitoring and Mitigation Plan” (see attachment D) developed for Pinto Valley Mining Corp.’s proposed action provides for a comprehensive approach to monitoring and tracking potential changes in groundwater quality and quantity in the shallow alluvial and deeper bedrock aquifers in and around the Pinto Valley Mine, surface water in Pinto Creek and selected tributaries, and selected seeps and springs. The plan also identifies monitoring triggers and mitigation measures, actions, and adaptive management that would be considered to reduce potential impacts. The Forest Service recommends that Pinto Valley Mining Corp. continually evaluate new techniques to improve water conservation practices and reduce evaporation. Other water conservation adaptive management activities not referenced in the plan may be also be identified by Pinto Valley Mining Corp. and implemented subject to Forest Service approval.

**Measure timing:**

This plan would be implemented following the record of decision and would persist during operation and the post-closure period.

**Source of measure:**

Developed by the Forest Service and Pinto Valley Mining Corp.

**Applicable alternatives:**

Proposed action. The plan would be updated specific to alternative 1, if selected.

**Authority to require:**

Authority is provided under 36 CFR 228.8, which indicates that operators should minimize adverse environmental effects to the extent feasible and implement practicable measures to maintain and protect fisheries and wildlife habitat that may be affected by the operations. In addition, the Tonto National Forest Plan (Forest Service 1985) indicates that water quality will be monitored in key locations to aid in the identification and correction of resource problems.

**Additional ground disturbance or other impacts that could result from implementation of this mitigation measure:**

This plan includes the installation of four new supplemental monitoring wells, including two pairs of wells in two locations. Preliminary locations identified for the supplemental monitoring wells would place the southernmost well pair on private lands owned by Pinto Valley Mining Corp. and the northernmost well pair on National Forest System lands. Pinto Valley Mining Corp. will finalize the locations to ensure that the wells are located outside the ordinary high-water mark of "waters of the United States." Locating the wells above the high-water mark of Pinto Creek will facilitate vehicle access and reduce the risk of flood damage and vandalism to the wells. A geophysical survey may be performed to confirm the approximate depth of the alluvium prior to drilling. Appendix A of the Comprehensive Water Resource Monitoring and Mitigation Plan provides standard operating procedures recommended by the U.S. Environmental Protection Agency for installing groundwater monitoring wells.

Potential impacts from installation and use of these wells could include surface disturbance from construction of well pads and access roads, noise and lighting during well drilling and completion activities, and potential for contamination of water-bearing zones. The size of the areas disturbed for installation of the supplemental monitoring wells is likely to be similar in size to the well pads of existing Peak Wells, which average approximately 0.06 acre per well. Depending on the final locations of the well pairs, construction new roads may be necessary to access and maintain the wells. Existing access roads for well pads at Pinto Valley Mine are an average of 25 feet in width and unpaved. Disturbances for new well pads and access roads would be relatively minor in comparison to total existing disturbances at Pinto Valley Mine; however, they may occur in riparian areas along Pinto Creek, which provide important habitat for a variety of terrestrial and aquatic wildlife species. Well construction could result in a small, but long-term, incremental contribution to cumulative loss of riparian habitat along Pinto Creek due to mining, drought, and other factors.

Noise from vehicle traffic, operation of heavy equipment, artificial lighting, and human presence during well drilling and completion activities, and to a lesser extent during ongoing well monitoring and maintenance, could result in impacts on wildlife species. These effects are anticipated to be localized and short term in duration and their intensity would depend on the location of the wells relative to wildlife habitats, the time of year and sensitivity of wildlife species to noise, the method of monitor well installation, and the size of the area affected by increases in noise above ambient levels.

Adherence to procedures recommended by the U.S. Environmental Protection Agency for installing groundwater monitoring wells, as provided in appendix A of this water plan, would minimize the potential for introduction of contaminants into the well bores, alteration of



groundwater chemistry with drilling mud, and cross-contamination of water-bearing zones. Risks of contamination would vary based on the method of monitor well installation but should be minimized through proper cleaning of drilling equipment and installation of well casing.

**Effectiveness of the mitigation measure:**

This measure would provide an effective means to monitor water quality and quantity for both groundwater and surface water resources to determine if mine-related activities are resulting in exceedances of identified thresholds. The plan would also describe the process and mitigation measures, actions, and adaptive management that would be considered if thresholds are exceeded.

**Mitigation Measure WR-2: Post-Closure Tailings Seepage Management Plan**

**Resource affected/impacts being mitigated:**

Seepage resulting from draindown from Tailings Storage Facility No. 3, Tailings Storage Facility No. 4, and the Cottonwood Tailings Impoundment is predicted to continue at progressively reduced rates for several decades after mine closure and then reach a low steady-state flow rate that would persist for the foreseeable future. The seepage may migrate downgradient (outside of the Pinto Valley Mine project boundary) and potentially discharge as baseflow in Pinto Creek. The high total dissolved solids and sulfate concentrations in the seepage from the facilities would likely degrade water quality in the groundwater system and in Pinto Creek downgradient of these facilities during the post-closure period and affect potential beneficial uses.

**Description of mitigation measure:**

The “Post-Closure Tailings Seepage Management Plan” (see attachment E) developed for Pinto Valley Mining Corp.’s proposed action provides information on the expected conditions of tailings storage facilities, modeling that has been performed to predict post-closure flow routes and water quality, the planned post-closure tailings seepage monitoring, and contingency plans for exceedances of water quality and site condition requirements, mitigation trigger thresholds, and adaptive management and contingency planning if there are monitored exceedances of thresholds. Refer to attachment E in this appendix for the complete “Post-Closure Tailings Seepage Management Plan.”

**Measure timing:**

This plan would be implemented during post-closure.

**Source of measure:**

Developed by the Forest Service and Pinto Valley Mining Corp.

**Applicable alternatives:**

Proposed action and alternative 1

**Authority to require:**

Authority is provided under 36 CFR, subpart 228.8, which indicates that operators should minimize adverse environmental effects to the extent feasible and implement practicable measures to maintain and protect fisheries and wildlife habitat that may be affected by the operations. In addition, the Tonto National Forest Plan (Forest Service 1985) indicates that

water quality will be monitored in key locations to aid in the identification and correction of resource problems.

**Additional ground disturbance or other impacts that could result from implementation of this mitigation measure:**

If compliance monitoring of tailings seepage water during the post-closure period meets contingency plan requirements for action and adaptive management in section 2.6 of Pinto Valley Mine's Aquifer Protection Permit, such as consistent exceedance of numeric water quality standards, Pinto Valley Mining Corp. will consider other adaptive or mitigation steps. The need for and types of specific on-the-ground activities that may be implemented have not been determined at this time, but could include installing a series of pump-back wells to capture tailings seepage and (1) pump untreated water to the Open Pit for evaporation or permanent storage; (2) treat captured water to meet Arizona Aquifer Water Quality Standards with subsequent re-injection to groundwater; or (3) treat captured water to meet Arizona Surface Water Quality Standards with subsequent release to Pinto Creek.

Implementation of options 1 or 3 may result in additional surface disturbance. Although the locations of these potential future disturbances are not known at this time, they would likely occur primarily within the footprint of existing facilities at Pinto Valley Mine and on private lands owned by Pinto Valley Mining Corp. Pipelines transporting captured water to the Open Pit or treated water to Pinto Creek may result in construction of a new treatment facility and pipelines on private or National Forest System lands. Unless placed within an existing right-of-way corridor, these disturbances would result in minor incremental contributions to cumulative soil disturbance, vegetation loss, erosion and sedimentation, and habitat fragmentation in the vicinity of Pinto Valley Mine.

If thresholds for adaptive management are exceeded and any of three storage or treatment options are implemented, surface- and groundwater quality in Pinto Creek is anticipated to improve if the system effectively reduces downgradient migration of contaminants.

**Effectiveness of the mitigation measure:**

This plan effectively describes post-closure tailings seepage monitoring and mitigation thresholds and contingency plans if monitoring indicates exceedances and adverse impacts on water resources from tailings seepage during the post-closure period.

### **Mitigation Measure WR-3: Watershed Workshop**

**Resource affected/impacts being mitigated:**

Mine-related water use and facilities would affect surface water quality and quantities and potentially affect beneficial uses downstream.

**Description of mitigation measure:**

Pinto Valley Mining Corp. would host and facilitate meetings annually, or as deemed necessary, that would include other Pinto Creek stakeholders including basin surface water rights holders and other agencies as deemed appropriate based on vested rights and interests. The purpose of these meeting is to discuss Pinto Valley Mine water use and the water budget for the Pinto Valley watershed. This group would review observed and modeled surface water flows, collaboratively examine the causes for divergence, and could propose additional recommended monitoring and mitigation measures to minimize potential impacts, which would include reviewing options for acquisition of future water supplies from elsewhere within or outside the Pinto Creek basin in order to reduce the impacts on Pinto

Creek surface resources from groundwater withdrawals. Workshop recommendations could pertain to actions including 1.) the design and implementation of any modifications to the monitoring plan; 2.) site-specific mitigation plans; or 3.) modifications to any implemented mitigation measures, if necessary. Pinto Valley Mining Corp. would publish the proceedings of the workshop in an annual report for the Forest Service's administrative project record.

Based on the input received at the watershed workshops, the findings in the published proceedings, and review of the monitoring results, the Forest Service could use an adaptive management approach to modify and adjust the monitoring program or could require the implementation of any necessary water resource-related mitigation measures to minimize effects on National Forest System resources attributable to the project.

**Measure timing:**

Meetings would occur annually, or as deemed necessary by the Forest Service, during operation, closure, and post-closure periods.

**Source of measure:**

Forest Service

**Applicable alternatives:**

Proposed action and alternative 1

**Authority to require:**

Authority is provided under 36 CFR 228.8, which indicates that operators should minimize adverse environmental effects to the extent feasible and implement practicable measures to maintain and protect fisheries and wildlife habitat that may be affected by the operations. In addition, the Tonto National Forest Plan (Forest Service 1985) indicates that water quality will be monitored in key locations to aid in the identification and correction of resource problems.

**Additional ground disturbance or other impacts that could result from implementation of this mitigation measure:**

There would be no surface disturbance or other impacts associated with this measure.

**Effectiveness of the mitigation measure:**

This measure would provide an effective means of tracking, coordinating, and addressing potential impacts on surface water resources.

## **Mitigation Measure WR-4: Water Rights Mitigation**

### **Resource affected/impacts being mitigated:**

Mine-induced drawdown and well field pumping could potentially reduce water levels and affect the active water rights within the projected drawdown areas.

### **Description of mitigation measure:**

Pinto Valley Mining Corp. is responsible for monitoring groundwater levels downstream of the mine to ensure surface water rights within the projected mine-related and well field-related drawdown area are not affected as part of the water resources monitoring program (see Mitigation Measure WR-1). Adverse impacts on water wells and water rights would be identified and mitigated as required under Arizona State law.

### **Measure timing:**

During operation, closure, and post-closure periods.

### **Source of measure:**

Developed by the Forest Service

### **Applicable alternatives:**

Proposed action and alternative 1

### **Authority to require:**

Authority is provided under 36 CFR 228, subpart A, which indicates that operators should minimize adverse environmental effects to the extent feasible and implement practicable measures to maintain and protect fisheries and wildlife habitat that may be affected by the operations (§228.8). Arizona surface water rights are generally regulated pursuant to Arizona Revised Statute 45-141 through 167.

### **Additional ground disturbance or other impacts that could result from implementation of this mitigation measure:**

There are no specific on-the-ground activities associated with this measure at this time. If future monitoring or other information indicates potential impacts on water rights and beneficial uses, adverse effects would be mitigated as required under Arizona State law. Depending on the nature of mitigation measures (such as water supply from different sources, and additional wells or pipelines), additional site-specific environmental review may be required.

### **Effectiveness of the mitigation measure:**

This measure would ensure that water quantity impacts are monitored and adverse impacts on water rights are addressed in accordance with Arizona State law.

## **5.0 References**

Oracle Environmental. 2016. Pinto Valley Mine Catchment Ponds O&M Manual. February 2016.

United States of America. 1972. Land Patent and Easement for Forest Road 287. Patent Number 02-72-0067.

U.S. Department of Agriculture, Forest Service (Forest Service). 1985. Tonto National Forest Management Plan, as modified. 1985.

U.S. Department of Agriculture, Forest Service (Forest Service). 2004. Training Guide for Reclamation Bond Estimation and Administration for Mineral Plans of Operation Authorized and Administered under 36 CFR 228A. April 2004.

WestLand Resources, Inc. 2019. Pinto Valley Mine Plan of Operations Historic Properties Treatment Plan. Tucson, Arizona. August 28.



## **ATTACHMENT A: BIOLOGICAL RESOURCES MONITORING AND MITIGATION PLAN**





**PINTO VALLEY MINE  
BIOLOGICAL RESOURCES MONITORING AND MITIGATION PLAN**

**Prepared for:** Pinto Valley Mining Corp.  
**Prepared by:** WestLand Resources, Inc.  
**Date:** June 5, 2020  
**Project No.:** 208.57

---

**TABLE OF CONTENTS**

1.	INTRODUCTION.....	1
2.	BACKGROUND.....	1
	2.1. Yellow-Billed Cuckoo .....	1
	2.2. Arizona Hedgehog Cactus.....	2
	2.3. Noxious or Invasive Weeds .....	2
	2.4. Raptor Nests and Special-Status Species.....	3
3.	METHODS.....	4
	3.1. Yellow-Billed Cuckoo .....	4
	3.1.1. Yellow-Billed Cuckoo Occupancy Monitoring .....	5
	3.1.2. Yellow-Billed Cuckoo Habitat Monitoring.....	7
	3.1.3. Grazing Monitoring.....	15
	3.1.4. YBC Reporting.....	15
	3.2. Arizona Hedgehog Cactus.....	16
	3.2.1. Methods.....	16
	3.2.2. Reporting.....	16
	3.3. Noxious and Invasive Weeds.....	17
	3.3.1. Monitoring Locations and Frequency.....	17
	3.3.2. Methods.....	17
	3.3.3. Reporting.....	17
	3.4. Raptor Nests and Special-Status Species.....	17
	3.4.1. Monitoring Locations and Frequency.....	18
	3.4.2. Methods.....	18
	3.4.3. Reporting.....	18
4.	MITIGATION MEASURES AND ADAPTIVE MANAGEMENT.....	18
5.	REFERENCES .....	20

**TABLES**

Table 1. Invasive Plants Documented in the Analysis Area.....3  
Table 2. Raptors and Special-Status Species with Known or Potential Occurrence  
in the Analysis Area.....4  
Table 3. Yellow-Billed Cuckoo Survey Dates per Protocol.....5  
Table 4. Ground Cover Types Recorded along Each Sampling Point .....11  
Table 5. Age Class Categories for Woody Plant Species Rooted within Belt Transects.....12  
Table 6. Categories of Vigor (Canopy Condition) for Nearest Tree in Point-Centered  
Quarter Sampling Plot Quadrants.....13  
Table 7. Variables and Metrics for 30 Percent Change Threshold.....14  
Table 8. Thresholds, Triggers, and Adaptive Management/Mitigation Measures by  
Species/Resource.....19

**FIGURES**

(follow text)

Figure 1. Analysis Area  
Figure 2. YBC Proposed Critical Habitat, Grazing Allotments, and Pastures  
Figure 3. YBC Survey Transects  
Figure 4. YBC Proposed Critical Habitat Riparian Habitat Monitoring Locations  
Figure 5. YBC Critical Habitat Riparian Habitat Monitoring Field Sampling Design

## I. INTRODUCTION

This plan outlines a program to monitor and mitigate potential impacts to biological resources from implementation of the Pinto Valley Mine Plan of Operations (MPO). Monitoring and mitigation will address the Endangered Species Act (ESA) listed threatened yellow-billed cuckoo (*Coccyzus americanus*; YBC) and its proposed critical habitat, the endangered Arizona hedgehog cactus (*Echinocereus triglochidiatus* var. *arizonicus*; AHC), noxious and invasive weeds, and raptor nests and other special-status species that may occur within the Analysis Area (as defined in the revised Biological Assessment prepared by the Tonto National Forest [TNF] for the MPO [Figure 1; USFS 2020]). The program will assist in determining if project-related effects to riparian vegetation and hydrology would impact YBC or its proposed critical habitat; if new project-related disturbance would impact AHC; and if implementation of the MPO would affect the occurrence, abundance, or distribution of noxious and invasive weeds, raptors, or other special-status species in the Analysis Area. This plan also identifies thresholds for these monitored ecosystem components and identifies possible mitigation/actions that could be taken if these thresholds are exceeded.

This plan provides background for these biological resources (Section 2), proposed monitoring methods (Section 3), impact thresholds and mitigation approaches (Section 4), and a list of references cited (Section 5).

## 2. BACKGROUND

### 2.1. YELLOW-BILLED CUCKOO

The western Distinct Population Segment (DPS) of YBC is listed as an ESA threatened species (USFWS 2014) with proposed critical habitat (USFWS 2020). In Arizona, YBC is most commonly found in lowland riparian woodlands where Fremont cottonwood, willow, velvet ash, Arizona walnut, mesquite, and tamarisk are dominant (USFWS 2013). This species also uses drier woodlands including mesquite bosques, drainages in desert scrub and desert grassland with a tree component, and Madrean evergreen woodlands in perennial, intermittent or ephemeral drainages (USFWS 2020). This species typically occurs at elevations less than 6,600 ft (AGFD 2011). YBC may migrate along riparian corridors and surrounding upland vegetation (Hughes 2015).

This species is a long-distance neotropical migrant (Hughes 2015). At the species level, YBC breeds throughout temperate North America south to Mexico and the Greater Antilles (Hughes 2015). The western DPS of YBC breeds west of the Continental Divide and the watershed boundary between the Rio Grande and Pecos River and the Chihuahuan Desert. The U.S. Fish and Wildlife Service (USFWS) considers the historical breeding range to include southern British Columbia, Canada and in Washington, Idaho, Nevada, Oregon, Utah, western Colorado, southwestern Wyoming, California, Arizona, western New Mexico, and Texas in the U.S. Breeding range extends into the Cape Region of Baja California Sur, Sonora, Sinaloa, western Chihuahua and northwestern Durango, Mexico (USFWS

2014). This species winters in South America, east of the Andes and typically south of the Amazon Basin in southern Brazil, Paraguay, Uruguay, eastern Bolivia and northern Argentina (USFWS 2014).

In Arizona, YBC is more common in southern, central and the extreme northeastern portion of state, but occurs throughout the state where suitable habitat exists (AGFD 2011). Yellow-billed cuckoos have been detected during surveys along various reaches of Pinto Creek in and near the Analysis Area in 1993, 2004, 2011, 2016, and 2017 but breeding has not been confirmed as a result of any surveys. The most recent protocol surveys, conducted by WestLand Resources, Inc. (WestLand), detected no YBC in 2015, three YBC in 2016, and one YBC in 2017. Because YBC were not detected on at least two separate occasions at least 10 days apart during any of the past surveys, possible or probable breeding by YBC along Pinto Creek cannot be inferred and these findings indicate the Analysis Area provides only dispersal and migration habitat for this species.

The USFWS published a revised proposal to designate critical habitat for YBC within the geographic range of the western DPS of the species (USFWS 2020). Perennial reaches of Pinto Creek are identified as proposed critical habitat and the Analysis Area includes portions of Unit 29: AZ-27 Pinto Creek North and Unit 26: AZ-24 Pinto Creek South (**Figure 2**).

## **2.2. ARIZONA HEDGEHOG CACTUS**

AHC is listed as an Arizona endemic (AGFD 2003) cactus and is listed as endangered with no designated or proposed critical habitat (USFWS 1979). This species grows in a variety of substrates including Apache Leap tuff, diabase, Dripping Spring quartzite, volcanic rocks, Pinal schist, quartz monzonite porphyry, quartz diorite, rhyolite, Schulte granite, Troy quartzite, Whitetail conglomerate and possibly Quaternary talus and Martin limestone (Baker 2013). Individuals are typically found in rock crevices, between boulders or on weathered bedrock in Interior chaparral and Madrean evergreen woodland (Baker 2013). AHC occurs between 3,300 and 5,800 ft (Baker 2013), and occasionally up to 6,360 ft (AGFD 2003).

Near the Analysis Area, this species occurs from Spencer Canyon in the Superstition Wilderness Area southeast to the Pinal Mountains and from just east to Superior to Pinto Creek, west of Miami. Additionally, there is a small subpopulation in the vicinity of El Capitan Peak in the Mescal Mountains (Baker 2013). The results of AHC surveys conducted by WestLand between 2008 and 2016 covered approximately 1,640 acres and a screening analysis was completed to determine potential presence in the 2015 and 2016 survey years. This analysis suggests that the Analysis Area provides marginal habitat and no AHC have been detected in pedestrian or optical surveys completed since 2008.

## **2.3. NOXIOUS OR INVASIVE WEEDS**

Invasive plant species or noxious weeds, referred to collectively as “invasive plants,” are defined for the purposes of monitoring as:

- Invasive plant species listed by the TNF (USFS 2018);
- Nonnative plant species considered invasive by the interagency Arizona Wildlands Invasive Plant Working Group (Arizona Wildlands Invasive Plant Working Group 2005); and
- Plant species listed as noxious weeds by the State of Arizona (Arizona Administrative Code R3-4-245).

Based on vegetation surveys and incidental observations between 2005 and 2017, 12 invasive plant species have been observed and documented in the Analysis Area (**Table 1**; USFS 2020).

**Table 1. Invasive Plants Documented in the Analysis Area**

Common Name	Scientific Name	TNF Status <sup>1</sup>	Arizona Wildlands Invasive Plant Working Group Status <sup>2</sup>
Bermudagrass	<i>Cynodon dactylon</i>	-	Medium
Fountain grass	<i>Pennisetum setaceum</i>	Class C	High
Lehmann lovegrass	<i>Eragrostis lehmanniana</i>	Class C	High
Mediterranean grass	<i>Schismus barbatus</i>	Class C	Medium
Red brome	<i>Bromus rubens</i>	Class C	High
Redstem filaree	<i>Erodium cicutarium</i>	-	Medium
Ripgut brome	<i>Bromus diandrus</i>	Class C	Medium
Russian thistle	<i>Salsola tragus</i>	Class C	-
Saltcedar (Tamarisk)	<i>Tamarix ramosissima</i>	Class C	High
Tree of heaven	<i>Ailanthus altissima</i>	Class C	-
Wild oats	<i>Avena fatua</i>	Class C	Medium
Yellow sweetclover	<i>Melilotus officinalis</i>	Class C	Medium

<sup>1</sup> Class C—weeds have spread beyond our capability to eradicate them. The USFS management goal is to contain the species' spread to its present size, then decrease the population if possible (USFS 2018).

<sup>2</sup> High—These species have severe ecological impacts on ecosystems; invasiveness attributes are conducive to moderate to high rates of dispersal and establishment; species are usually widely distributed. Medium—These species have substantial and apparent ecological impacts on ecosystems; invasiveness attributes are conducive to moderate to high rates of dispersal, often enhanced by disturbance; ecological amplitude and distribution range from limited to widespread (Arizona Wildlands Invasive Plant Working Group 2005).

TNF biologists identified several other invasive plant species that may be present in the general vicinity, but have not been formally documented: wild oats (*Avena fatua*), Sahara mustard (*Brassica tournefortii*), Globe chamomile (*Oncosiphon piluliferum*), field bindweed (*Convolvulus arvensis*), and Malta starthistle (*Centaurea melitensis*).

#### 2.4. RAPTOR NESTS AND SPECIAL-STATUS SPECIES

Raptors (birds of prey species) may be protected under Migratory Bird Treaty Act (MBTA) or the Bald and Golden Eagle Protection Act (BGPA), or may be managed as management indicator or sensitive species under the National Forest Management Act. Other special-status species include plant, fish, amphibian, reptile, bird, and mammal species identified as Forest Service sensitive (FS

Sensitive) or management indicators (MIS). **Table 2** lists raptors, FS Sensitive, and MIS known to occur or with potential to occur in the Analysis Area (USFS 2020).

**Table 2. Raptors and Special-Status Species with Known or Potential Occurrence in the Analysis Area**

Common Name	Scientific Name	Status <sup>1</sup>	Known or Potential Occurrence in Analysis Area
Arizona alum root	<i>Heuchera glomerulata</i>	FS Sensitive	Potential, unlikely
Mogollon fleabane	<i>Erigeron anchana</i>	FS Sensitive	Potential, unlikely
Desert sucker	<i>Catostomus clarkii</i>	FS Sensitive	Known
Lowland leopard frog	<i>Rana yavapaiensis</i>	FS Sensitive	Known
Bezy's night lizard	<i>Xantusia bezyi</i>	FS Sensitive	Potential
Golden eagle	<i>Aquila chrysaetos</i>	FS Sensitive, BGPA, MBTA	Potential
Bald eagle	<i>Haliaeetus leucocephalus</i>	FS Sensitive, BGPA, MBTA	Potential
Ash-throated flycatcher	<i>Myiarchus tyrannulus</i>	MIS, MBTA	Known
Gray vireo	<i>Vireo vicinior</i>	MIS, MBTA	Known
Juniper titmouse	<i>Baeolophus ridgwayi</i>	MIS, MBTA	Known
Spotted towhee	<i>Pipilo maculatus</i>	MIS, MBTA	Known
Black-chinned sparrow	<i>Spizella atrogularis</i>	MIS, MBTA	Known
Horned lark	<i>Eremophila alpestris</i>	MIS, MBTA	Known
Black-throated sparrow	<i>Ampispiza bilineata</i>	MIS, MBTA	Known
Bell's vireo	<i>Vireo bellii</i>	MIS, MBTA	Known
Summer tanager	<i>Piranga rubra</i>	MIS, MBTA	Known
Hooded oriole	<i>Icterus cucullatus</i>	MIS, MBTA	Known
Western wood- pewee	<i>Contopus sordidulus</i>	MIS, MBTA	Known
Common black-hawk	<i>Buteogallus anthracinus</i>	MIS, MBTA	Known
Red-tailed hawk	<i>Buteo jamaicensis</i>	MBTA	Known
Allen's big-eared bat	<i>Idionycteris phyllotis</i>	FS Sensitive	Potential
Western red bat	<i>Lasiurus blossevillii</i>	FS Sensitive	Potential

<sup>1</sup> FS Sensitive=TNF sensitive species list, BGPA=Bald and Golden Eagle Protection Act, MBTA=Migratory Bird Treaty Act, MIS=Management Indicator Species

### 3. METHODS

#### 3.1. YELLOW-BILLED CUCKOO

The objectives for this component of the plan are to monitor occupancy of the Analysis Area by YBC across temporal periods and to determine breeding status if applicable (**Section 3.1.1**). This monitoring will also evaluate and track changes in the Physical and Biological Factors (PBF) of proposed critical habitat along Pinto Creek and its tributaries (USFWS 2020; **Section 3.1.2**). In addition, a grazing monitoring program will be initiated where Pinto Valley Mine Corp (PVMC) controlled grazing allotments overlap YBC proposed critical habitat (**Section 3.1.3**). **Section 3.1.4** provides details on data deliverables and reporting for YBC.

**3.1.1. Yellow-Billed Cuckoo Occupancy Monitoring**

YBC surveys will target currently proposed critical habitat, which includes areas where YBC have previously been detected. Transects will be surveyed along the mainstem of Pinto Creek and two of its tributaries to cover proposed critical habitat in and near the Analysis Area. These transects will include the stream morphology and vegetation monitoring locations identified in **Section 3.1.2** to allow comparison/correlation of YBC habitat use/occupancy with riparian habitat condition measured during long-term monitoring efforts. YBC surveys will occur in the Analysis Area in three areas:

1. Pinto Creek downstream of Gold Gulch to and including the short reach of West Fork Pinto Creek proposed as critical habitat – a reach within the modeled 5-foot phreatic surface change contour (zone).
2. Pinto Creek upstream and downstream of Apache Canyon – a reach located outside and just downstream of the modeled 5-foot phreatic surface change zone, and
3. Pinto Creek upstream and downstream of Haunted Canyon and the short reach of Haunted Canyon proposed as critical habitat – a reach outside of and upstream of the modeled 5-foot phreatic surface change zone.

YBC transect locations are depicted on **Figure 3**. YBC surveys will be conducted once every 3 years for the duration of active mining or until the western DPS of the species is delisted.

YBC surveys will be conducted following the methods described in the 2015 survey protocol (Halterman et al. 2015). The YBC survey protocol requires four survey visits over three survey periods for each site, with an approximate schedule of survey times between mid-June and mid-August (**Table 3**). Per the protocol, surveys will be completed a minimum of 12 days apart and no more than 15 days between survey visits.

**Table 3. Yellow-Billed Cuckoo Survey Dates per Protocol**

Survey Dates	Survey Number
Survey Period 1 - June 15 to 30 (one survey required)	1
Survey Period 2 - July 1 (±3 days) to 31 (±3 days) (two surveys required)	2 3
Survey Period 3 - August 1 to 15 (one survey required)	4

Surveys will begin at sunrise and will continue no later than 11:00 AM and will not be conducted in inclement weather conditions, including temperatures of 104°F (40°C) or greater. Surveyors will broadcast a series of recorded YBC contact calls at points spaced approximately 100 meters (m) apart along each transect. At each point, following a 1-minute listening period, five YBC contact calls will be broadcast at 1-minute intervals, while surveyors actively listen and watch for YBC. Surveyors will also listen for YBC

while walking between calling points. If YBC are detected spontaneously or in response to the playback, the next broadcast point will be moved approximately 300 m from the estimated location of the detected bird to reduce the risk of drawing it away from a potential nesting area.

Survey results will be interpreted following the methods described in the protocol to estimate the breeding status of YBC and the number of possible, probable, and confirmed breeding territories in an area (Halterman et al. 2015, USFWS and Reclamation 2019). Definitions of the breeding territories per the protocol followed by the interpretation that will be used, are:

*Possible breeding territory:* “Detections within a 300 - 500 m area during at least 2 surveys and 12 - 14 days apart”. For example, within a certain area, one detection made during Survey Period 2 coupled with another cuckoo detection made 12-14 days later, also during Survey Period 2, warrants a possible breeding territory designation.” This will be interpreted to signify that possible breeding territories are areas where two or more total detections occur during two survey visits (rather than survey periods) that are at least 12 days but no more than 14 days apart.

*Probable breeding territory:* “Detections within a 300 - 500 m area during at least 3 surveys and 12-14 days apart; or PO [possible breeding] territory plus purposeful food carry (single observation, bird does not eat food), stick carry (single observation), multiple incidents of alarm calls in same area, or PO territory plus pair exchanging multiple kowlp or alarm calls (not coos) within 100 m of one another”.

This will be interpreted to signify that probable breeding territories are areas where three or more total detections occur during at least three survey visits (rather than survey periods), with at least 12 days but no more than 14 days between each detection. A possible breeding territory coupled with at least one of the previously stated observations also qualifies an area as a probable breeding territory.

*Confirmed breeding territory:* “Observation of active nest (or multiple stick carries to nest being built), copulation, fledgling (unable to fly) with adult; or PR [probably breeding territory] plus multiple food carries to same area; or distraction display (dropped wing)”. This will be interpreted to signify that confirmed breeding territories are areas where at least one of these observations has been made.

A survey report will be prepared and submitted by September 30 of each survey year. The report will include a summary of YBC natural history, a description of the survey area and methods, and a discussion of the results. Results of the surveys will also be summarized in table format and appendices will include completed survey summary forms and ground-level photographs.



### **3.1.2. Yellow-Billed Cuckoo Habitat Monitoring**

The primary objective for this component of the monitoring plan is to monitor changes to riparian habitat and stream morphology along Pinto Creek over time. The ultimate objective is to inform any management actions that may be needed to address project-related changes. Monitoring under this component of the plan will target multiple reaches of Pinto Creek and will incorporate control sites to account for variability caused by factors unrelated to PVMC mining activity. The sampling design will allow monitoring of any changes within sites over time, between test and control sites, and among all sampled sites over time. It will also allow comparison of data with long term monitoring efforts that have been completed upstream of the analysis area. This YBC habitat monitoring uses the PBFs established by the proposed critical habitat publication as the basis for design (USFWS 2020).

PBFs described as essential for YBC by the USFWS in the 2020 proposal for critical habitat are (USFWS 2020):

- PBF 1—Riparian woodlands, mesquite woodlands (mesquite-thorn-forest), and Madrean evergreen woodland drainages.
- PBF 2—Adequate prey base. Presence of prey base consisting of large insect fauna (for example, cicadas, caterpillars, katydids, grasshoppers, large beetles, dragonflies, moth larvae, spiders), lizards, and frogs for adults and young in breeding areas during the nesting season and in post-breeding dispersal areas.
- PBF 3—Hydrologic processes, in natural or altered systems, that provide for maintaining and regenerating breeding habitat.

PBF 1, the habitat component, will be monitored using a riparian habitat and vegetation monitoring program. PBF 2, the prey component, will not be monitored directly but will be inferred based on riparian habitat conditions monitored over time. PBF 3, the hydrology component, will be monitored using channel morphology across temporal periods and will be related to any changes in riparian habitat conditions over time. Specific aspects of the riparian habitat monitoring program will provide information on hydrologic processes related to maintenance and regeneration of habitat for YBC (e.g., tree density, health, species composition, canopy cover, age structure, recruitment, estimated stream flow/volume, etc.). Water quantity and quality will be monitored as part of the Comprehensive Water Resources Monitoring and Mitigation Plan and will inform this monitoring and mitigation plan with regard to these variables.

#### **3.1.2.1. Monitoring Locations**

The monitoring for both PBF 1 and PBF 3 will share the same locations. Monitoring locations (sampling sites) will be established along four distinct reaches of Pinto Creek and along one tributary

reach to document potential changes in riparian vegetation over time (**Figure 4**). Two of these sampling sites have been selected to monitor potential changes along Pinto Creek in:

- A reach within the modeled 5-foot phreatic surface change zone, and
- A reach outside but downstream of the modeled 5-foot phreatic surface change contour.

Three additional sampling sites will serve as controls to assess potential changes in riparian vegetation due to factors other than phreatic surface change, such as regional weather variability or long-term climate change (e.g., precipitation patterns, extended drought), or other natural causes. These will consist of:

- A reach of Pinto Creek outside and upstream of the modeled 5-foot phreatic surface change zone.
- A reach of Pinto Creek outside of but bounded at its upstream and downstream ends by the modeled 5-foot phreatic surface change zone.
- A tributary reach along upper Haunted Canyon, West Fork Pinto Creek, Horrell Creek, or another suitable reach that is located outside of and upstream of the modeled 5-foot phreatic surface change contour and supports similar vegetation.

Control sites outside the Pinto Creek watershed were not considered. Stream reaches within the watershed but outside the phreatic surface change zone (i.e., areas potentially affected by PVMC mining-related changes in phreatic surface) serve as the most suitable control sites because they are geographically proximate, more likely to be subject to similar local climatic conditions/events, occur at similar elevations, and support comparable plant communities.

Proposed sampling sites are identified in **Figure 4** and described in more detail below. Each of these sites will be monitored annually for an initial 3-year period. Monitoring results will be reviewed with the TNF after the initial 3-year period to analyze any changes in riparian habitat conditions, the need for any mitigation measures or adaptive management actions, and the frequency of subsequent monitoring efforts (annual, biennial, or other). If substantial changes in riparian condition are observed after the first year of monitoring (e.g., in the second year of monitoring), consultation and review by the TNF take place at that time and not delayed until after the initial 3-year period. Monitoring will continue until 6 years after mine closure and cessation of well field pumping. The five stream reaches to be monitored are identified as follows:

**Pinto Creek No. 1** (control; reach outside and upstream of change in phreatic surface). This monitoring location represents a reach of Pinto Creek immediately upstream and downstream of Haunted Canyon. This reach is located outside of and upstream of the modeled 5-foot phreatic surface change zone and will therefore serve as a control for riparian vegetation

condition along a reach that would not be affected by potential PVMC mining-related changes to the phreatic surface. It should be noted that this reach of Pinto Creek has been monitored since 1996 by Carlota Mine. One of the permanent sampling plots from that monitoring effort occurs along this reach and therefore contributes long-term monitoring data related to Carlota Mine operations. Sampling along this reach will complement prior and on-going monitoring efforts and will provide additional data for comparison. This reach has pedestrian access via the road/trail access that leads to the Haunted Canyon trailhead off Forest Road (FR) 287.

**Pinto Creek No. 2** (reach within change in phreatic surface). This monitoring site corresponds to a reach of Pinto Creek that is located immediately upstream and downstream of Iron Bridge and within the 5-foot phreatic surface change zone. This reach will be used to monitor effects of potential PVMC mining-related changes to the phreatic surface on riparian vegetation. This reach is accessible via the road/trail access that leads to the Haunted Canyon trailhead off FR 287.

**Pinto Creek No. 3** (reach outside change in phreatic surface). This monitoring location represents a reach of Pinto Creek downstream of Gold Gulch and upstream of West Fork Pinto Creek; it is downgradient from Pinto Valley Mine and Carlota Mine. This reach is outside but bounded at both its upstream and downstream end by the modeled 5-foot phreatic surface change zone. It therefore has the potential to be affected indirectly by change in the phreatic surface. This reach runs parallel to and is generally accessible via FR 287.

**Pinto Creek No. 4** (reach outside and downstream of change in phreatic surface). This site corresponds to a reach of Pinto Creek upstream and downstream of Apache Canyon, downgradient of Pinto Valley Mine and Carlota Mine. This reach of the creek is located outside and just downstream of the modeled 5-foot phreatic surface change zone and downgradient of tailings storage facilities and may therefore be indirectly affected by change in the phreatic surface. Pedestrian access will be gained to this site from the north end/terminus of FR 287.

**Tributary No. 1** (control; tributary reach outside and upstream of phreatic surface change). A monitoring location will be selected along a tributary of Pinto Creek to serve as a control for Pinto Creek No. 2 (reach within change in phreatic surface). Potential locations include upstream reaches of Haunted Canyon, West Fork Pinto Creek, and Horrell Creek. The location of this sampling site will be determined based on aerial photo and field reconnaissance and using the following criteria: (1) location outside and upstream of the modeled 5-foot phreatic surface change zone, (2) vegetation type that is comparable to that in Pinto Creek No. 2, and (3) accessibility.

### 3.1.2.2. PBF I Monitoring

PBF 1 sampling methods are based on a published U.S. Forest Service (USFS) monitoring protocol and will yield data to determine changes in riparian vegetation over time and will also be both complementary and comparable with other long-term monitoring data collected by others along Pinto Creek (e.g., for Carlota Mine). The methodology is based on the USFS National Riparian Core Protocol (USDA 2017) and will yield data that includes ground cover by stratum for woody and herbaceous plant species, and woody plant density/mortality that will be analyzed for changes over time, both within and among sampling sites.

The sampling design includes a series of line-point intercept and belt transects with embedded point-centered quarter sampling plots. Transects will be established following a structured sampling design. Each of the test and control reaches will be subdivided into five sub-reaches (**Figure 5a**). Each sub-reach will begin and end with a vegetation sampling transect that is oriented perpendicularly to the stream. Thus, each of stream reaches will have five sample transects evenly distributed for a total sample of 25 transects. Each transect will be laid out perpendicular to the stream course and will extend between the upland boundaries on each side of the stream. Transect start and end points will be marked with rebar or other monumentation and recorded with Global Positioning System (GPS) instrumentation with sub-decimeter accuracy for re-measurement during monitoring in subsequent years. Data collection methods are described in detail below. Field vegetation data collected will be complemented by ground-level photography, aerial photography, and LiDAR described under **Section 3.1.2.3**.

Ground cover by stratum for woody and herbaceous plant species will be collected at intervals along the line-intercept transect established within each of the five sub-reaches comprising each monitoring location/stream reach (**Figure 5b**). Transects will be variable in length based on the lateral extent of the stream and associated floodplain terrace/riparian zone. Vegetation data will be collected at each meter interval along the line-intercept transect using a vertical pole method that measures an index of total vegetation volume (TVV) or biomass at decimeter height intervals. This methodology has been used extensively in Arizona and has been correlated with breeding bird density (Mills, Dunning, and Bates 1991).

The measurement pole is extendable up to 6 m and is marked in decimeter (dm) sections. At each m interval, the measurement pole is placed vertically, and the observer counts the number of dm sections that contain vegetation within a radius of 1 dm from the pole. This results in the sampling of a series of cylinders 0.1 m tall and 0.1 m in radius. Each dm cylinder that contains vegetation is called a “hit.” The number of possible hits in each meter layer above the ground ranged from 0 to 10. The number of hits per meter layer and the plant species responsible for each hit are recorded on a standardized data form. If two or more plant species are present in the same meter layer, the total number of hits in that layer are allotted between the plant species according to the relative dominance of each plant

within the layer. The pole is held above the observer’s head to count the number of hits in layers up to 8 m above ground. The number of hits in layers > 8 m are visually estimated. TVV is estimated from these data as:  $TVV=h/10p$ ; where h = the total number of hits summed over all m layers at all points measured, and p=the number of points at which vegetation volumes were measured. TVV has the units of cubic m of vegetation per square m ( $m^3/m^2$ ). This technique overestimates actual vegetation volume because each dm cylinder containing any vegetation, regardless of amount, was counted as full. However, it yields an index of vegetation volume that can be compared between sampling efforts to detect vegetation change. The TVV methodology for the line-point intercept transect will yield data on percent plant cover by stratum, an estimate of canopy cover, plant species composition and relative abundance. The data can also be used to estimate plant height and foliage height diversity.

In addition to vegetative cover by stratum, ground cover will be recorded at each m interval sampling point along the transect per the categories identified in the National Riparian Core Protocol (**Table 4**).

**Table 4. Ground Cover Types Recorded along Each Sampling Point**  
(each m interval along the variable length line-point intercept [TVV] transect)

Physical	Organic
Bare soil – sand (<0.1mm) (BARE1)	Basal vegetation (list plant code on form) (BAVE)
Bare soil – clay silt (0.1-2 mm) (BARE2)	Bryophyte – cryptogams, mosses, and lichens (CML)
Gravel – (>2-7 5mm) (GRAV)	Wood (WOOD)Number of plants per unit area
Cobble (75-250 mm) (COBB)	Number of plants per unit area
Boulder (>600 mm) (BOUL)	
Bedrock (BEDR)	Litter: including leaf, needle litter and other dead plant material or animal droppings (LITT)
Water (WATE)	

Woody plant density and mortality or condition will be measured using a combination of belt transects and point-centered quarter sampling plots. Belt transects will be 4 m in width and will be centered along the variable length line-point intercept (TVV) transect established in each sub-reach of every monitoring location/stream reach (**Figures 5a and 5b**). After collecting TVV data along the transect, as described above, the observer will walk along the length of the transect while extending a 2-m section of pole on either or both sides of the transect line and record the number of woody plant individual by species, rooted within the belt transect limits. At the outside edges of the belt transect, a plant will be judged to be rooted within if more than 50 percent of its canopy occurs within the belt transect/plot. In addition to species, each individual plant within the belt transect will be recorded by age class to allow comparison of long-term monitoring data by others (**Table 5**).

Tree mortality will be further monitored by counting, mapping, and characterizing dead or critically stressed trees greater than 40 cm in diameter-at-breast height within 20 m of each side of the transect

centerline and not already recorded within the 4-m belt transect, resulting in a 40-m belt transect for quantification of larger trees that are dead or critically-stressed.

**Table 5. Age Class Categories for Woody Plant Species Rooted within Belt Transects**

Age Class Category and Code	Definition
Seedling (SEE)	Trees less than 12 inches in height Shrubs less than 6 inches in height
Young (YOU)	Trees between 12 inch in height and 1 inch diameter-at-breast height (dbh) Shrubs between 6 and 12 in in height
Sapling (SAP)	Trees between 1 and 3 inches dbh Shrubs – not applicable
Pole Trees (POL)	Trees between 1 and 3 inches dbh
Immature (IMM)	Trees between 6 and 12 inches dbh
Mature (MAT)	Trees over 12 inches dbh

Point-centered quarter plots will be established at intervals along each of the line-point intercept (TVV) transects to provide an additional measure of tree density and tree mortality. These plots will also provide data on basal area, frequency, and condition of individual trees.

Point-centered quarter sampling plots will be located at consistently spaced intervals, corresponding to specific intervals along each variable length line-point intercept (TVV) transect. Two sampling plots will be established within the riparian zone on each streambank, as space allows (without trees in adjacent sampling overlapping), but at least one point-centered sampling plot will be established on each bank, yielding a minimum of two per transect/sub-reach and minimum of 10 plots for each monitoring location/stream reach (**Figure 5c**). The location of sampling point will be recorded using GPS instrumentation with sub-dm accuracy to allow re-sampling of plots in subsequent monitoring years.

At point-centered quarter sampling point, the transect and line oriented perpendicular to the transect will define the four sampling plot quadrants. At each sampling point, the nearest tree in each of four quadrants will be identified by species and the distance to that tree from the point measured (**Figure 5c**). The basal area of the nearest tree in each quadrant will be measured using a diameter tape or calipers and the overall condition of the tree will be recorded as live or dead. If recorded as live, the condition or health of the nearest tree in each quadrant will be estimated as a visual determination of percentage of live canopy relative to potential crown volume. This will be recorded using vigor classes identified in the National Riparian Core Protocol (**Table 6**). If possible, the cause of diminished vigor will be recorded (WS, water stress; PD, pathogens or disease; MD, mechanical damage such as wind, falling branches, or human canopy removal; I, insects; or UK, unknown/other). If the nearest tree in a quadrant is recorded as live, the distance to the nearest dead tree in that quadrant will also be recorded.

**Table 6. Categories of Vigor (Canopy Condition) for Nearest Tree in Point-Centered Quarter Sampling Plot Quadrants**

<b>Vigor</b>	<b>Criteria for Assessing Condition</b>
Critically stressed	Major leaf death and or branch die back (>50% of canopy volume affected)
Significantly stressed	Prominent leaf death and or branch die back (21–50% of canopy volume affected)
Stressed	Minimal leaf death and or branch die back (11–20% of canopy volume affected)
Mildly stressed	Little or no sign of leaf stress (between 5%–10% of canopy affected)
Vigorous	No sign of leaf stress/very healthy-looking canopy (<5% of canopy affected)

**3.1.2.3. PBF 3 Monitoring**

In order to detect potential changes in stream characteristics and the associated YBC habitat a stream morphology sampling framework was designed (PBF 3). This methodology is based on the Rosgen Stream Classification (Rosgen 1985) methods for stream channel evaluation. The sampling locations will consist of those identified in **Section 3.1.2.1**. This approach will allow characterization of stream condition that can be compared across temporal scales and management condition.

At the center of the stream channel along the vegetation monitoring transects described in **Section 3.1.2.1**, detailed stream channel morphological data will be collected. These data include channel slope, width to depth ratio, bed material, entrenchment ratio, sinuosity, maximum water depth, distance from source point, velocity, substrate class, channel morphology, and vegetation characteristics.

A systematic nested sampling approach will be used to collect variables associated with Rosgen’s classification. Sampling cells will consist of a 1-m quadrat centered on flowing water (or the deepest channel point) within the channel nested in a 1-m wide rectangular sample cell that will extend one meter past the channel banks on either side.

Channel slope and sinuosity will be spatially derived, while width to depth ratio, bed material and entrenchment ratio will be calculated from field sampling data. In order to calculate width to depth ratio we will divide the channel width by the bankfull depth at each sample cell. Bed material will be calculated from the mean percent cover of each substrate class. An entrenchment ratio will be calculated by dividing the width of the floodplain at each sample cell by the width of the channel.

The quantitative field data collected in the above data collection structure will be complemented using three qualitative data sources: ground level photography, LiDAR and aerial photography. These complementary data will allow documentation and interpretation of qualitative changes in channel morphology relative to quantitative data collected in the field.

Ground-level photography will be taken at each sampling point. Photographs will be taken and repeated using a tripod that allows photos to be taken at the same height, in the same direction, and same angle. This will yield four ground-level photos per sub-reach or a total of 20 per monitoring location/stream reach.

LiDAR data will be collected at the same points/locations as the ground-level photo monitoring points described above. LiDAR data will be collected using the handheld GeoSLAM Horizon mobile LiDAR unit. This device allows the user to create a point cloud of large areas by focusing the unit on a target area and collecting. While the photo points will provide a visual representation, the LiDAR data will provide a structural estimate that can be compared across sample periods.

Aerial photography will be analyzed using remotely sensed Normalized Vegetation Density Index (NVDI). The NVDI sampling will occur using a spatially explicit GIS-based approach and will cover the entire stream reach representing each monitoring location/site. This data index can then be correlated with quantitative vegetation data collected in the field and will allow for comparison of any changes in vegetation density or canopy cover over the monitoring period related to changes in channel morphology. These qualitative visual data will also be used to inform the vegetation monitoring. As available, historical aerial photography will be reviewed for broad patterns of change along Pinto Creek prior to initiation of monitoring, though no quantitative analysis will be completed.

**3.1.2.4. Analysis of Threshold Values**

Quantitative vegetation data collected for PBF-1 will be analyzed for chronic changes over time that trigger consultation with the TNF to discuss potential need for adaptive management strategies or actions. Thresholds will be the same as those used for the Haunted Canyon vegetation monitoring program implemented by Carlota Mining. The specific trigger for consultation with TNF is the exceedance of threshold values for 8 of the following 10 variables listed in **Table 5**. Threshold exceedance is defined as a 30-percent change in the variables compared with values recorded during the first monitoring year (**Table 7**).

**Table 7. Variables and Metrics for 30 Percent Change Threshold**

Variable	Metric
Tree stratum cover	TVV above 5 m
Shrub stratum cover	TVV for woody species from 1 to 5 m
Herbaceous stratum cover	TVV for non-woody species
Total ground cover	percent cover by type
Cover composition	TVV contributed by riparian vs. upland species
Density composition	woody stem density of riparian vs. upland species
Riparian shrub density	woody stem density for plants 1 to 5 m in height
Riparian tree density	woody stem density for plants > 5 m in height
Total density of riparian woody plants	woody plant density for all riparian species
Tree health	proportion of trees by vigor class



Threshold exceedances will be evaluated relative to control sites and water monitoring results from the Comprehensive Water Resources Monitoring and Mitigation Plan (CWRMMP) to evaluate potential causes for any changes observed.

### **3.1.3. Grazing Monitoring**

Units 26 and 29 of the proposed critical habitat for YBC lie partially within the Pinto Creek Grazing Allotment for which PVMC is the permittee. Fencing has been installed that excludes livestock from Pinto Creek around large portions of the proposed critical habitat units that fall within the allotment (**Figure 2**) Concurrently with the YBC habitat monitoring described in **Section 3.1.2**, the exclusion fence will be inspected for breaches and the areas included in the YBC habitat monitoring will be observed for evidence of cattle activity (e.g., cows, tracks, and droppings). Any breaches or evidence of cattle activity will be immediately reported to the grazing allotment permittee, the rancher responsible for the allotment, and the TNF in accordance with the grazing permit. Fence integrity or breaches and cattle activity or lack thereof, will be documented. A narrative description of observations associated with cattle activity will be included in each YBC monitoring report. The TNF Range Specialist holds an Annual Operating Instructions meeting each year, then issues the Annual Operating Instructions which includes a pasture rotation schedule.

### **3.1.4. YBC Reporting**

#### **3.1.4.1. Yellow-Billed Cuckoo Occupancy Monitoring**

A YBC occupancy monitoring report will be submitted once every 3 years following survey protocol completion, unless and until YBC is delisted. This report will contain detection information (if any), photos, and all other data collected during the surveys. A draft report will be prepared to summarize the results of the surveys. The report will be organized in a standard format, including an introduction, methods and materials, results, discussion, and references section. Information regarding any YBC detections that were made during the surveys will be provided in a table. Estimates of the number of individual YBC detected and breeding territories will be made based on survey results and following the methods described in the YBC Survey Protocol and the 2019 draft amendment (Halterman et al. 2016). Figures (U.S. Geological Survey [USGS] topographic maps) depicting survey areas and the estimated locations of YBC detections and territories will also be provided. Survey forms and photographs taken during the survey will be included as appendices.

#### **3.1.4.2. Yellow-Billed Cuckoo Habitat Monitoring**

A YBC habitat monitoring report will be prepared after each monitoring effort. Each report will summarize methods and results of field data collection and statistical analyses. The report will include summaries of field data collected, by method and measurement variable, in table format. Copies of completed data forms, ground-level photos, and NVID/LiDAR images will be included as appendices. The report will quantify and discuss any changes in riparian vegetation condition

compared with prior monitoring efforts, including monitoring completed along Pinto Creek by others. The analysis and report will examine any trends as they relate to surface and groundwater monitoring data. Any significant trends or changes in riparian habitat and vegetation condition along Pinto Creek after 2027, as indicated by exceedance of thresholds defined in the previous section, will be identified and, as appropriate, a recommendation will be included in the report to consult with the TNF to discuss any potential adaptive management strategies or actions that may be warranted. Within each YBC habitat monitoring report a narrative description of observations associated with cattle activity and observations of raptor nests and other special-status species (FS Sensitive, MIS, MBTA, and BGPA) will be included.

### **3.2. ARIZONA HEDGEHOG CACTUS**

Monitoring AHC will specifically address potential effects of new disturbance on TNF lands identified in the MPO. The approximate 229 acres corresponding to TNF lands identified for disturbance under the MPO have been previously surveyed and no AHC have been found. Monitoring under this plan will consist of one final pre-disturbance survey to ensure that no AHC became established and that no AHC are present that may have been missed in previous surveys.

#### **3.2.1. Methods**

The survey will be conducted prior to planned surface disturbance. The survey will include two techniques: pedestrian and binocular surveys. The pedestrian survey will be completed by qualified botanists using transects spaced no more than 10 m apart to obtain complete coverage of the survey area. Any areas that are too steep to be accessed safely (generally greater than 30-percent slopes) will be surveyed with binoculars. The survey will be conducted during the peak flowering period for AHC, which typically occurs from mid-April into the first week in May. Flowering by AHC in the general vicinity of the analysis area will be confirmed prior to completing each survey, to ensure optimal detectability. Any AHC located will be mapped in the field using GPS instrumentation with sub-dm accuracy or mapped on aerial photography if occurring on steep inaccessible terrain. General age, health, number of stems, and flowering phenology/status will be recorded for any AHC found.

#### **3.2.2. Reporting**

A report will be prepared following the survey that outlines the methods and results of the AHC survey. The report will describe in detail field methodology and will identify areas where effective pedestrian surveys were completed and areas that were visually surveyed as a result of steep terrain. Mapping will be included to show the location of any AHC discovered and information on general age, health, number of stems, and flowering phenology/status will be reported. Ground-level photographs will be included as an appendix to the report. If AHC are located in the field, coordination with the TNF and USFWS will take place to determine appropriate and feasible mitigation action such as preservation in place or relocation.

### **3.3. NOXIOUS AND INVASIVE WEEDS**

The objective will be to monitor the occurrence, abundance, and change in distribution of noxious and invasive weeds in USFS system lands in the Analysis Area. Monitoring results will inform the need for implementation of specific measures for control of noxious and invasive plant species through development of a noxious and invasive weed treatment plan.

#### **3.3.1. Monitoring Locations and Frequency**

Noxious weed surveys will be completed on the 229 acres of TNF lands that will be disturbed as part of the proposed action and along FR 287 from its south terminus at U.S. Highway 60 to its north terminus in the Analysis Area. Surveys on the 229 acres will be conducted 1 year prior to surface disturbance to document existing conditions and inform any treatments prior to disturbance. FR 287 will be surveyed prior to disturbance and in every year that riparian habitat monitoring for YBC occurs.

#### **3.3.2. Methods**

Surveys will be completed during one outing in late spring or early summer. Lands subject to surface disturbance will be surveyed on foot using transects spaced no further than 10 m apart. Patches of noxious weeds will be mapped using GPS instrumentation as polygons or buffered line features and attributes collected will include species and estimate percent cover class. FR 287 will be surveyed by vehicle and weed patches will be mapped as off-set buffered line features with the same attributes collected. Species mapped will be any invasive or noxious plant species as identified in **Section 2.3**. Number of noxious weed plant stems (stem density) or precise cover will not be estimated. The objective for surveys will be to determine presence/absence and approximate abundance of invasive or noxious weed species.

#### **3.3.3. Reporting**

A report will be prepared following each survey year that describes the methods and results of the noxious weed survey. Results will be discussed and presented in table format that includes species, location, and approximate abundance. The report will include maps showing the locations and extent of noxious weeds in the surveyed areas, as well as representative ground-level photographs. Results will be discussed in relation to potential treatment options or best management practices.

### **3.4. RAPTOR NESTS AND SPECIAL-STATUS SPECIES**

The objective for this component of the plan is to document the potential occurrence of nesting raptors and the presence of other species status species on TNF lands subject to disturbance under the proposed action and along Pinto Creek within the Analysis Area. Special-status species are defined as FS sensitive species, MIS, and species protected under the BGPA or the MBTA.

### **3.4.1. Monitoring Locations and Frequency**

Raptor nests and the occurrence of special-status species will be documented on the 229 acres of TNF lands subject to disturbance under the proposed action prior to surface disturbance and during the course of YBC surveys and riparian area monitoring and AHC and noxious weed surveys. If raptor nests are located prior to surface disturbance, a follow-up survey (if needed) will be conducted 30 days immediately prior to surface disturbance on TNF lands to determine nesting status and allow implementation of avoidance of mitigation measures.

Raptor nests and the occurrence of special-status species will be recorded incidentally during the course of other monitoring efforts in the Analysis Area, specifically YBC surveys and habitat monitoring along Pinto Creek and its tributaries.

### **3.4.2. Methods**

Surveys for raptor nests and the occurrence of special-status species will be completed concurrently with AHC and noxious weed surveys on the 229 acres of federal land to be disturbed and during YBC surveys and habitat monitoring detailed in **Section 3.3**. Any raptor nests or special-status species encountered will be mapped using GPS instrumentation with sub-dm accuracy or mapped on aerial photography if in steep inaccessible terrain. Information collected on any raptor nests will include raptor species, nest substrate, approximate height, and nesting stage if it can be visually determined. All efforts and observations will be incidental to AHC, noxious weed, and YBC survey and monitoring work. No species-specific surveys for plants, fish, herptiles, birds, or mammals will be completed.

### **3.4.3. Reporting**

Any raptor nests or special-status species findings will be included as part of the AHC, noxious weed, YBC survey, or habitat monitoring reports. A separate stand-alone report will be prepared if a follow-up survey is completed 30 days prior to surface disturbance of the 229 acres of federal lands. The report will include a detailed description and mapped locations of any raptor nests and special-status species detected during field surveys. Ground-level photographs will be included for any such resources encountered, and recommendations will be made for further actions.

## **4. MITIGATION MEASURES AND ADAPTIVE MANAGEMENT**

Specific thresholds are identified whose exceedance will trigger consideration of adaptive management and mitigation actions. The general process will involve consultation with the TNF when results of survey or monitoring efforts indicate the exceedance of specific thresholds identified in any one monitoring year (YBC monitoring will occur annually for the initial 3-year period, after which results will be reviewed with TNF, except if thresholds are exceeded sooner after the first year of monitoring.

Table 8 lists monitoring thresholds by species or resource and potential mitigation actions that may be considered and implemented through consultation with the TNF.

**Table 8. Thresholds, Triggers, and Adaptive Management/Mitigation Measures by Species/Resource**

Species/Resource	Threshold/Trigger	Potential Adaptive Management Actions or Mitigation Measures
YBC	30 percent change in 8 out of 10 vegetation variables identified in <b>Table 6</b> compared with values recorded during the first year of monitoring (tree stratum cover, shrub stratum cover, herbaceous stratum cover, total ground cover, cover composition, density composition, riparian shrub density, riparian tree density, total density of riparian woody plants, tree health)	<ul style="list-style-type: none"> <li>• Further reductions and deferments in the Pinto Creek Grazing Allotment</li> <li>• Upland habitat restoration to improve/increase habitat and prey base that would benefit YBC</li> <li>• Options for reducing water-resource related impacts resulting from mine drawdown that could be affecting the YBC habitat.</li> <li>• Possible mitigation measure options that may be identified in the CWRMMP relevant for YBC habitat</li> </ul>
AHC	Documented presence of AHC on federal lands to be disturbed	<ul style="list-style-type: none"> <li>• Protection in place</li> <li>• Relocation/transplanting</li> </ul>
Noxious and Invasive Plants	Identification of new noxious or invasive plant species in the analysis area or 30-percent increase in abundance of known documented species	<ul style="list-style-type: none"> <li>• Development and implementation of a noxious and invasive species treatment plan</li> </ul>
Raptor Nests and Special-Status Species	Identification of raptors nests and special-status species on federal lands to be disturbed or along Pinto Creek.	<ul style="list-style-type: none"> <li>• Avoidance of nest sites during the breeding season</li> <li>• Relocation of active nests/young</li> <li>• Monitoring of raptor nest reproductive success over the monitoring timeframe</li> <li>• Monitoring of special-status species populations along Pinto Creek over the monitoring timeframe</li> </ul>

## 5. REFERENCES

- Arizona Game and Fish Department. 2003. Arizona Hedgehog Cactus (*Echinocereus triglochidiatus* var. *arizonicus*). *Unpublished abstract compiled and edited by the Heritage Data Management System*. Phoenix, Arizona: Arizona Game and Fish Department. October 2, 2003. 7 pp.
- \_\_\_\_\_. 2011. Yellow-billed Cuckoo (*Coccyzus americanus*). *Unpublished abstract compiled and edited by the Heritage Data Management System*. Phoenix, Arizona: Arizona Game and Fish Department. October 31, 2011. 6 pp.
- Arizona Wildlands Invasive Plant Working Group. 2005. Invasive Non-Native Plants That Threaten Wildlands in Arizona: A Categorized List Developed by the Arizona Wildlands Invasive Plant Working Group. August 2005. 23 pp.
- Baker, Marc A. 2013. Draft Recovery Plan for (*Echinocereus arizonicus*) subsp. *arizonicus* (Arizona Hedgehog Cactus). *Prepared for the U.S. Fish and Wildlife Service*,. September 19, 2013. 82 pp.
- Halterman, Murrelet D., Matthew J. Johnson, Jennifer A. Holmes, and Stephen A. Laymon. 2015. A Natural History Summary and Survey Protocol for the Western Distinct Population Segment of the Yellow-billed Cuckoo Final Draft. *U.S. Fish and Wildlife Techniques and Methods*: U.S. Fish and Wildlife Service. April 22, 2015. 45 pp.
- \_\_\_\_\_. 2016. A Natural History Summary and Survey Protocol for the Western Distinct Population Segment of the Yellow-billed Cuckoo. *U.S. Fish and Wildlife Techniques and Methods*: U.S. Fish and Wildlife Service. May 2016.
- Hughes, Janice M. 2015. "Yellow-billed Cuckoo (*Coccyzus americanus*), version 2.0." In *The Birds of North America [online]*, edited by P.G. Rodewald. Ithaca, New York: Cornell Lab of Ornithology.
- Mills, G. Scott, John B. Dunning, and John M. Bates. 1991. "The Relationship Between Breeding Bird Density and Vegetation Volume." *The Wilson Bulletin* 103 (3):468-479.
- Rosgen, David L. 1985. A Stream Classification System. *Symposium: Riparian Ecosystems and Their Management*. Tucson, Arizona. April 16, 1985.
- U. S. Fish and Wildlife Service, and U.S. Bureau of Reclamation. 2019. Draft Addendum to Appendices 1 to 3 for yellow-billed cuckoo survey protocol in Arizona, New Mexico, and Texas: in Halterman, M.D., M.J. Johnson, J.A. Holmes and S.A. Laymon. 2016. A Natural History Summary and Survey Protocol for the Western Distinct Population Segment of the Yellow-billed Cuckoo: Draft. *U.S. Fish and Wildlife Techniques and Methods*. June 2019.
- U.S. Department of Agriculture. 2017. The National Riparian Core Protocol: A Riparian Vegetation Monitoring Protocol for Wadeable Streams of the Conterminous United States. *Forest Service Rocky Mountain Research Station Gen. Tech. Rep. RMRS-GTR-367*. November 2017.
- U.S. Fish and Wildlife Service. 1979. Determination that *Echinocereus triglochidiatus* var. *arizonicus* is an Endangered Species. *Federal Register*. October 25, 1979. 3.

- \_\_\_\_\_. 2013. Endangered and Threatened Wildlife and Plants; Proposed Threatened Status for the Western Distinct Population Segment of the Yellow-billed Cuckoo (*Coccyzus americanus*); Proposed Rule. U.S. Department of Interior. October 3, 2013. *Federal Register*, 78:61622-61666.
- \_\_\_\_\_. 2014. Endangered and Threatened Wildlife and Plants; Determination of Threatened Status for the Western Distinct Population Segment of the Yellow-billed Cuckoo (*Coccyzus americanus*); Final Rule. U.S. Department of Interior. October 3, 2014. *Federal Register*, 79:59992-60038.
- \_\_\_\_\_. 2020. Endangered and Threatened Wildlife and Plants; Revised Designation of Critical Habitat for the Western Distinct Population Segment of the Yellow-Billed Cuckoo; Proposed Rule. U.S. Department of Interior. *Federal Register*, 85:11458-11594.
- U.S. Forest Service. 2018. Tonto National Forest Service Invasive Species List. Phoenix, Arizona: U.S. Department of Agriculture.
- \_\_\_\_\_. 2020. Pinto Valley Mine Environmental Impact Statement Biological Assessment. U.S. Department of Agriculture. April 2020.

---

**FIGURES**



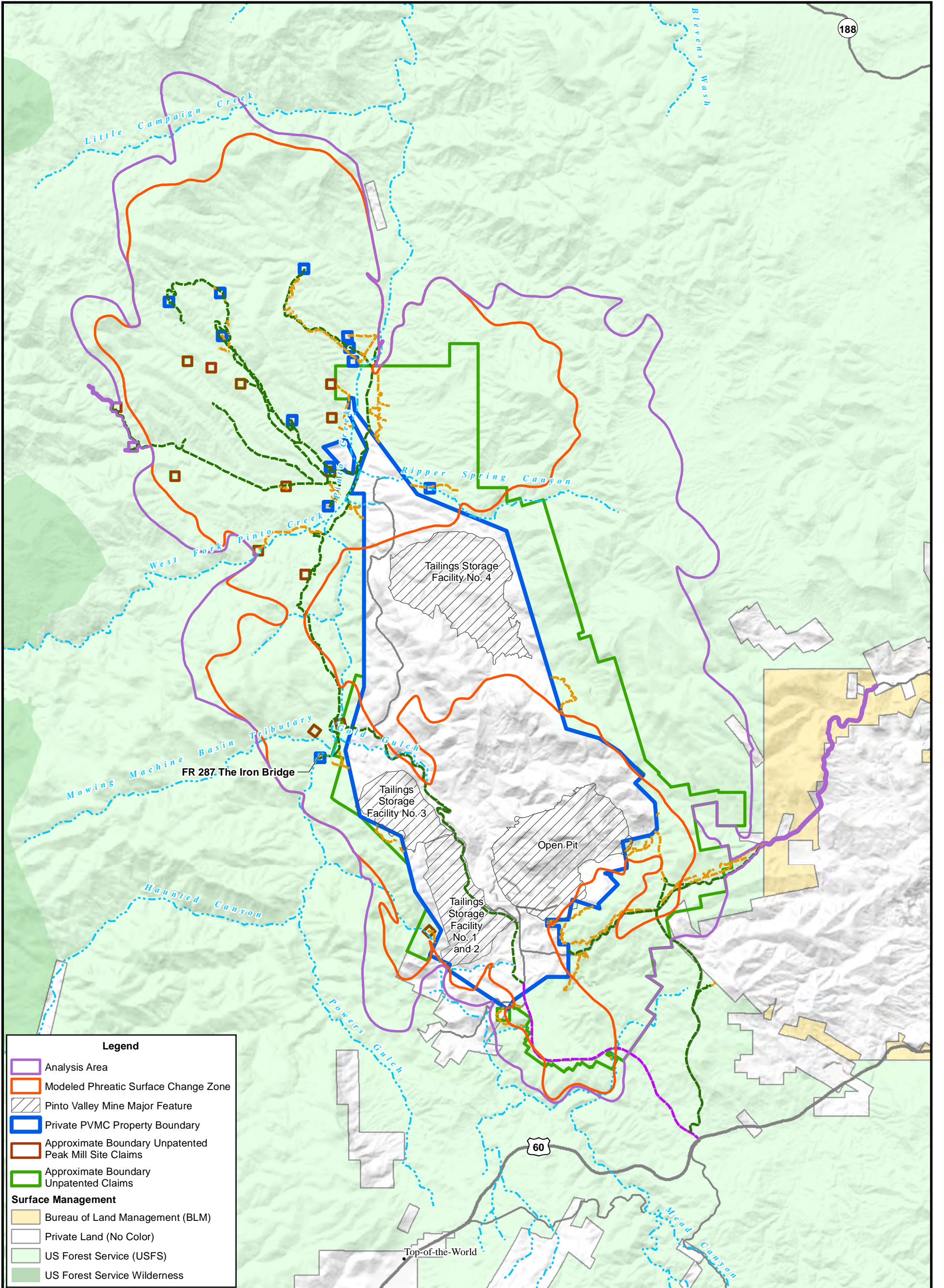

Private PVMC Property Boundary as surveyed and approximate boundary Unpatented PVMC Claims in portions of T1N, R13E; T1N, R14E; T1S, R14E; and T2N, R13E, Gila County, Arizona, PVMC Property Boundary provided by AJAX Record of Survey 12/04/2015 Unpatented PVMC Claim Boundary provided by Cornerstone 03/26/2015 Analysis Area: ICF 06/03/2020 Flow Regime: ArcGIS Online - ADEQ Water Flow Regimes, WRI Modified 2020 Image Source: ArcGIS Online, USGS Shaded Relief Basemap

**PINTO VALLEY MINING CORP.**  
 NEPA Support  
 Pinto Creek Biological Resources  
 Monitoring and Mitigation Plan

ANALYSIS AREA  
 Figure 1

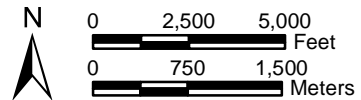

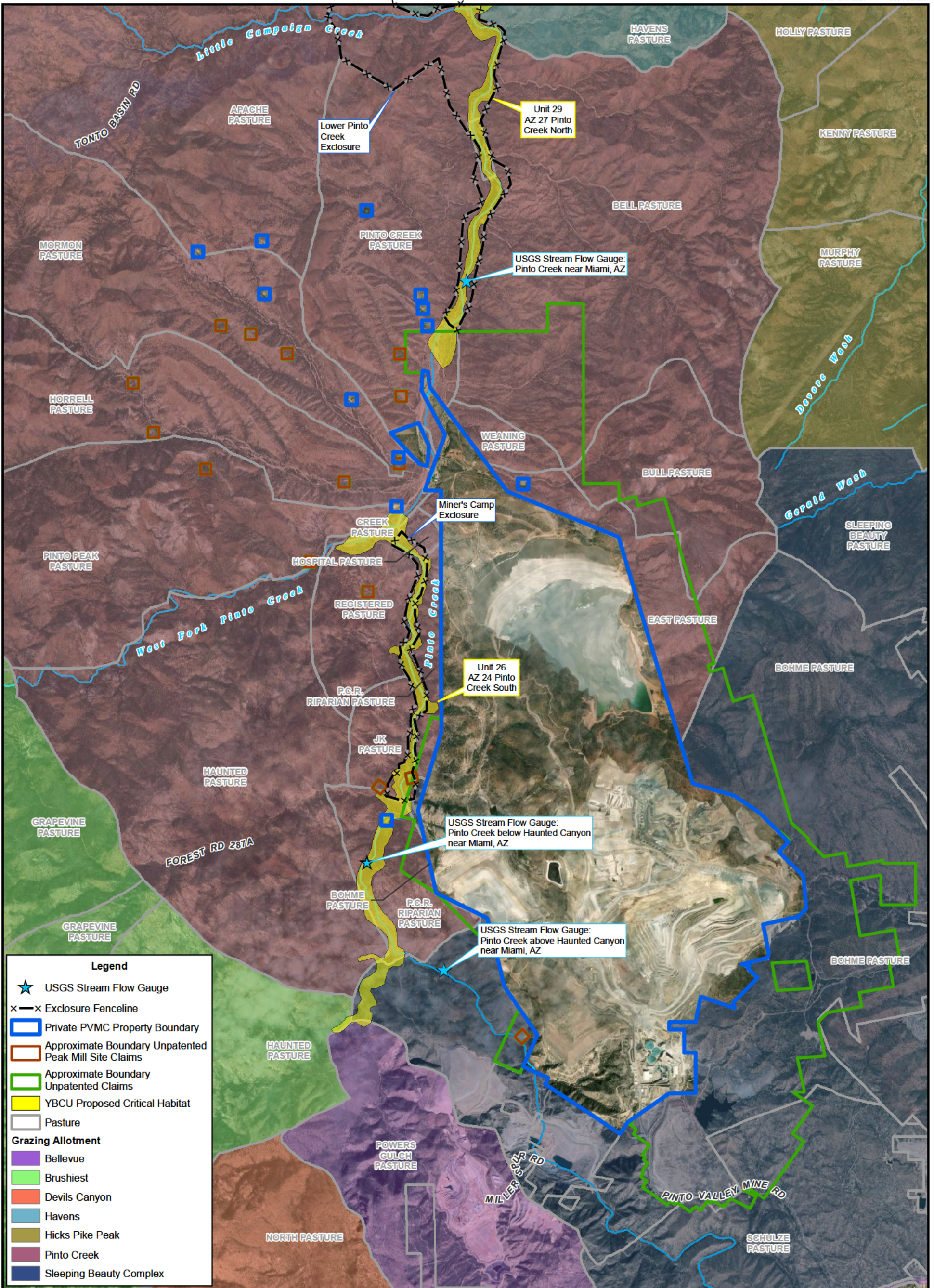

Private PVMC Property Boundary as surveyed and approximate boundary Unpatented PVMC Claims in portions of T1N, R13E; T1N, R14E; T1S, R14E; and T2N, R13E, Gila County, Arizona, PVMC Property Boundary provided by AJAX Record of Survey 12/04/2015 Unpatented PVMC Claim Boundary provided by Cornerstone 03/26/2015 Stream Flow Gauge: USGS, Pasture and Grazing Allotments: USDA Forest Service Southwestern Region posted 01/05/2021 Proposed Critical Habitat: USFWS 02/27/2020 Image Source: ArcGIS Online, World Imagery 02/06/2018

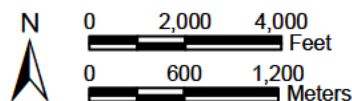

**PINTO VALLEY MINING CORP.**  
NEPA Support  
Pinto Creek Biological Resources  
Monitoring and Mitigation Plan

YELLOW-BILLED CUCKOO  
PROPOSED CRITICAL HABITAT,  
GRAZING ALLOTMENTS, AND PASTURES,

Figure 2

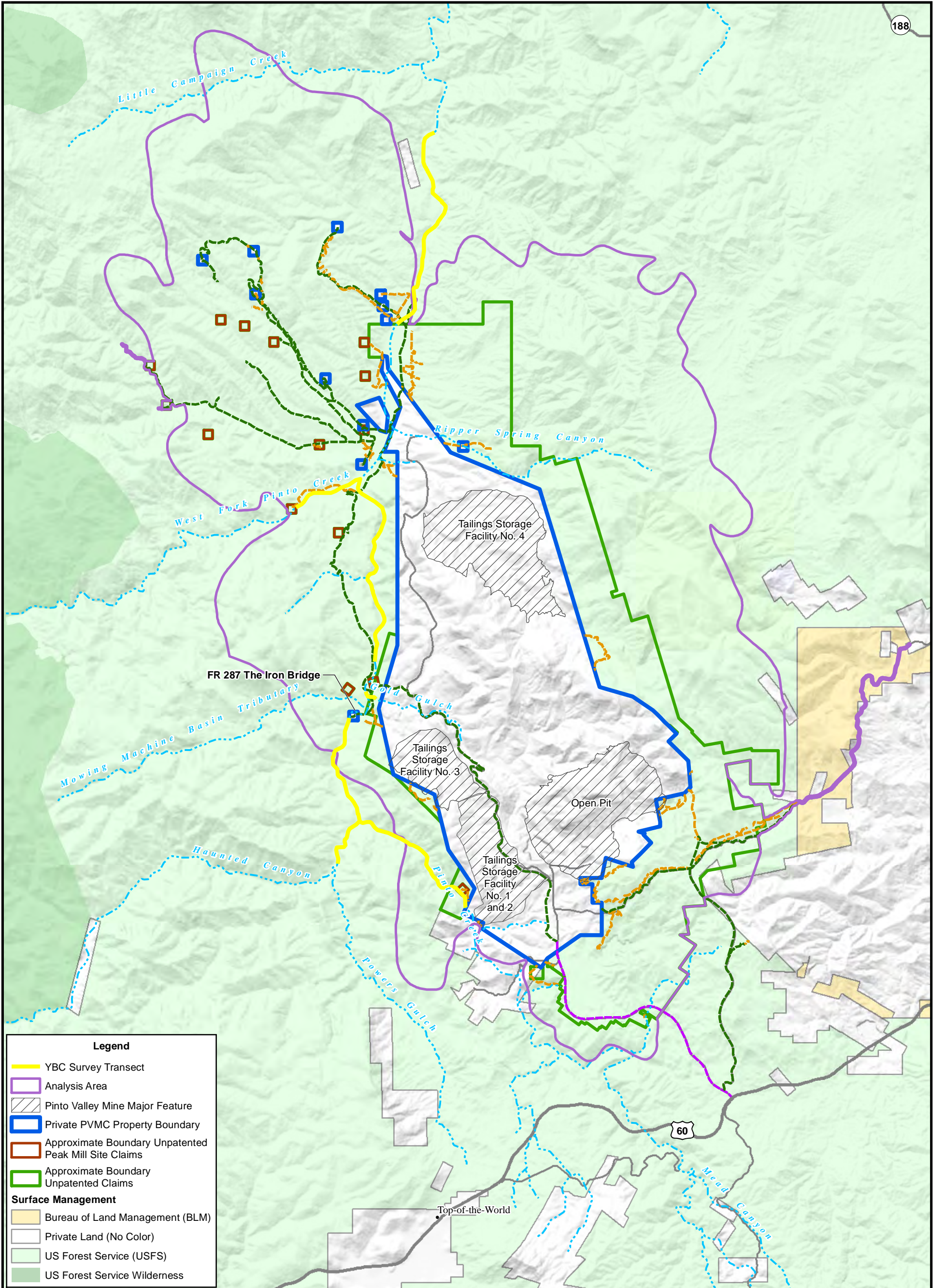

**Legend**

- YBC Survey Transect
- Analysis Area
- Pinto Valley Mine Major Feature
- Private PVMC Property Boundary
- Approximate Boundary Unpatented Peak Mill Site Claims
- Approximate Boundary Unpatented Claims

**Surface Management**

- Bureau of Land Management (BLM)
- Private Land (No Color)
- US Forest Service (USFS)
- US Forest Service Wilderness

Private PVMC Property Boundary as surveyed and approximate boundary Unpatented PVMC Claims in portions of T1N, R13E; T1N, R14E; T1S, R14E; and T2N, R13E, Gila County, Arizona, PVMC Property Boundary provided by AJAX Record of Survey 12/04/2015 Unpatented PVMC Claim Boundary provided by Cornerstone 03/26/2015 Data Source: ICF Flow Regime: ArcGIS Online - ADEQ Water Flow Regimes, WRI Modified 2020 Image Source: ArcGIS Online, USGS Shaded Relief Basemap

**PINTO VALLEY MINING CORP.**  
**NEPA Support**  
**Pinto Creek Biological Resources**  
**Monitoring and Mitigation Plan**

**YELLOW-BILLED CUCKOO**  
**SURVEY TRANSECTS**

Figure 3

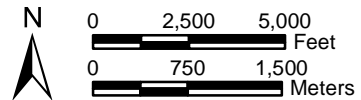

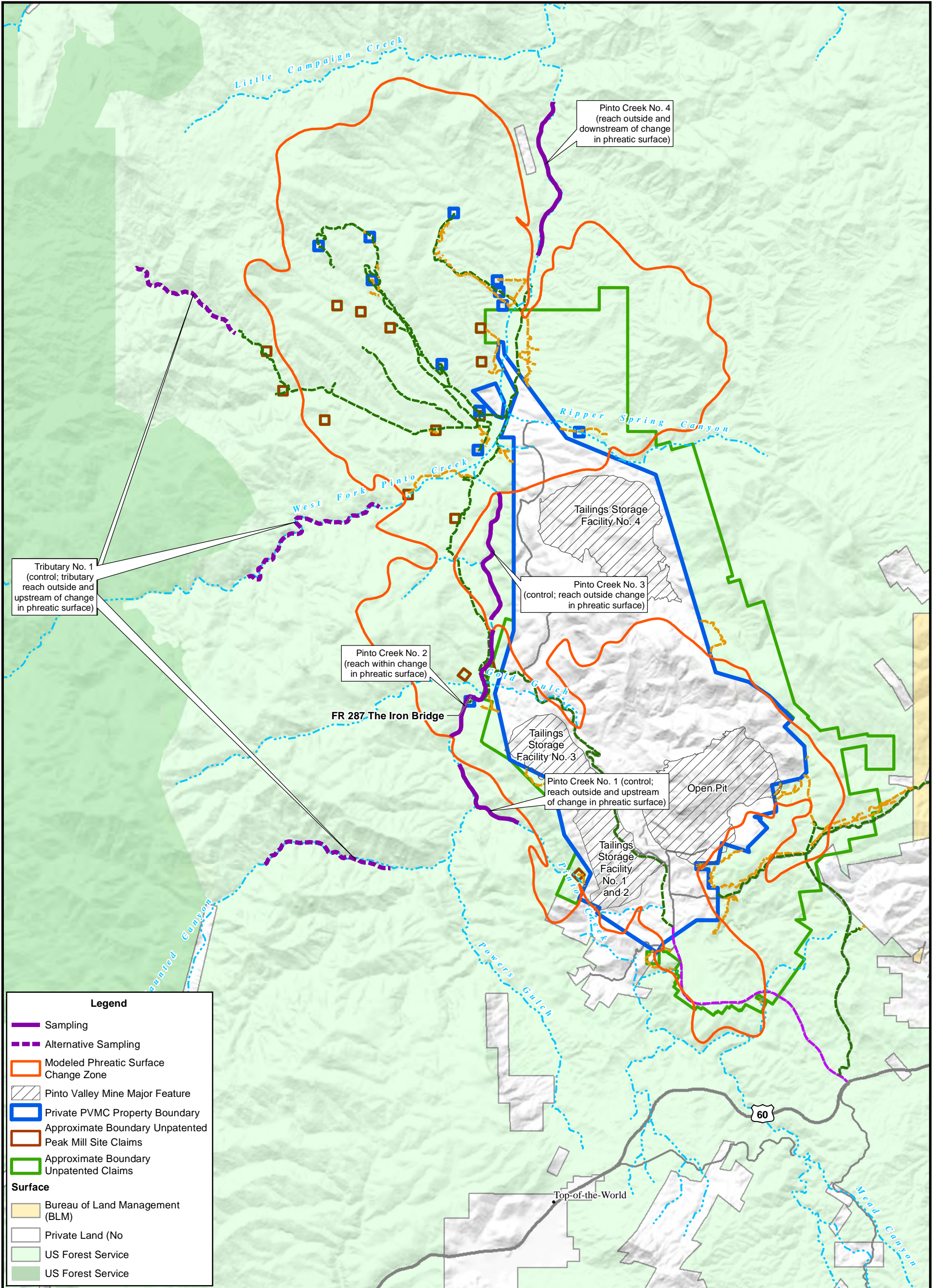

Private PVMC Property Boundary as surveyed and approximate boundary Unpatented PVMC Claims in portions of T1N, R13E; T1N, R14E; T1S, R14E; and T2N, R13E, Gila County, Arizona, PVMC Property Boundary provided by AJAX Record of Survey 12/04/2015 Unpatented PVMC Claim Boundary provided by Cornerstone 03/26/2015 Data Source: ICF Flow Regime: ArcGIS Online - ADEQ Water Flow Regimes, WRI Modified 2020 Image Source: ArcGIS Online, USGS Shaded Relief Basemap

**PINTO VALLEY MINING CORP.**  
 NEPA Support  
 Pinto Creek Biological Resources  
 Monitoring and Mitigation Plan

YELLOW-BILLED CUCKOO  
 PROPOSED CRITICAL HABITAT  
 RIPARIAN HABITAT MONITORING LOCATIONS

Figure 4

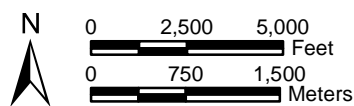



**PINTO VALLEY  
MINING CORP.**  
  
**Biological Resources  
Monitoring and  
Mitigation Plan**  
  
**YBC CRITICAL HABITAT  
RIPARIAN HABITAT  
MONITORING FIELD  
SAMPLING DESIGN**  
  
**Figure 5**

**Figure 5a. Sample Location Sub-reaches**

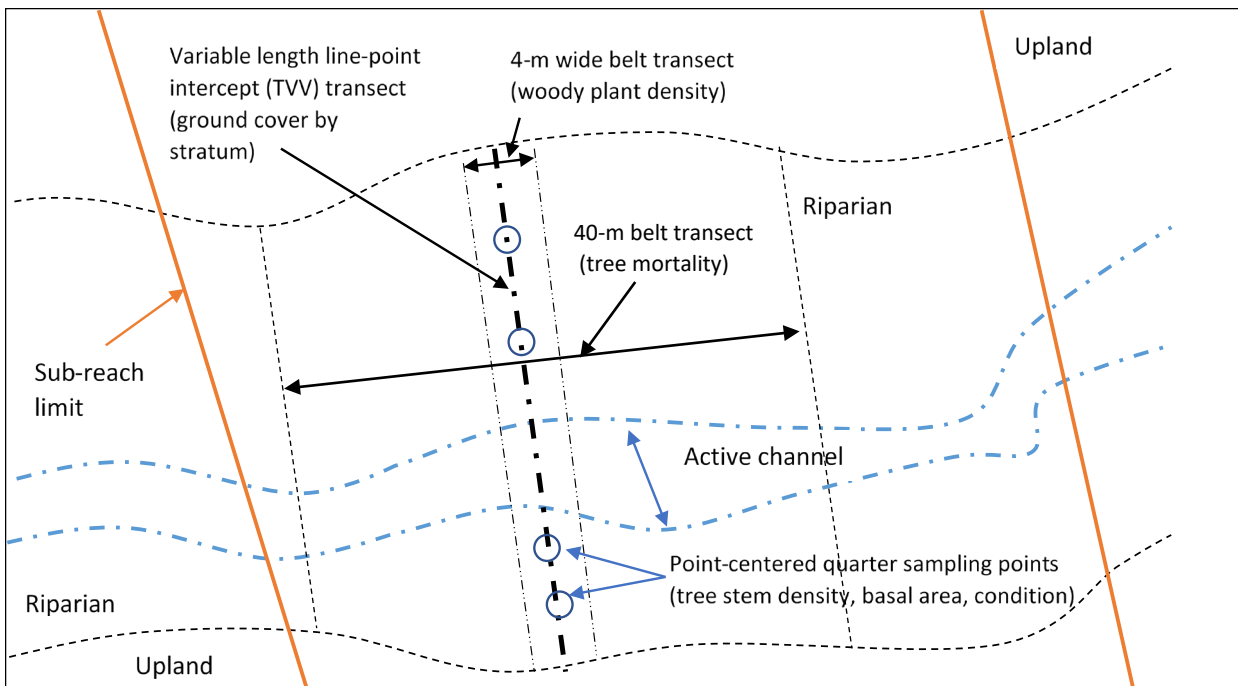

**Figure 5b. Sampling Design**

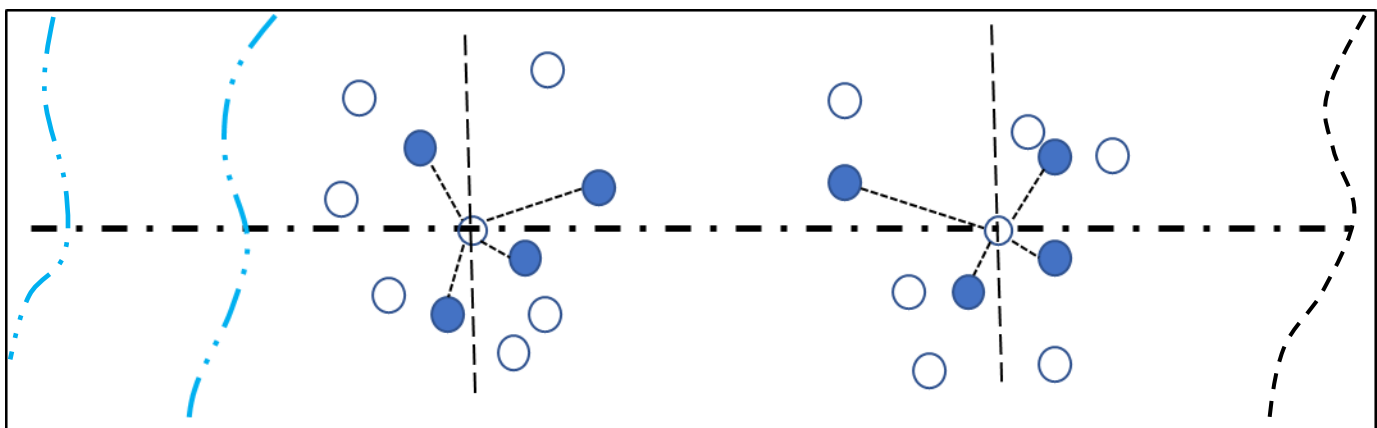

**Figure 5c. Point-centered Quarter Detail**



## **ATTACHMENT B: OPEN PIT WALL STABILITY AND MITIGATION PLAN**







# **Pinto Valley Mine**

## **Pit Wall Stability and Mitigation Plan**

**July 31, 2020**



# Table of Contents

<b>1</b>	<b>Introduction .....</b>	<b>1</b>
1.1	Purpose and Objectives .....	1
1.2	Background.....	1
1.3	Pit Design and Recommended Setbacks.....	1
1.3.1	Slope Design Criteria.....	2
1.3.2	Life-of-Mine Pit Design .....	3
1.3.3	Recommended Setbacks for Leaching and Waste Rock Facilities.....	4
1.3.4	Recommended Maximum Inter-Ramp Slope Angles for the LOM Pit.....	4
<b>2</b>	<b>Geotechnical Conditions.....</b>	<b>5</b>
2.1	Geotechnical Characterization .....	5
2.1.1	Geotechnical Domains .....	5
2.1.2	Geological Structures .....	6
2.1.3	Hydrogeologic Conditions During Mining and Post-Closure Periods.....	6
2.2	Review of Historical and Existing Slope Failures and Creep in the Pit.....	6
2.2.1	Historical Slope Failures.....	7
2.2.2	Current Slope Failures and Creep.....	8
2.3	Existing Slope Monitoring System.....	9
<b>3</b>	<b>Stability Evaluation .....</b>	<b>11</b>
3.1	Stability Analysis.....	11
3.1.1	Input Parameters and Assumptions .....	11
3.1.2	Pore Pressure Conditions.....	11
3.1.3	Acceptance Criteria .....	12
3.2	Results.....	14
3.2.1	Mining Period.....	14
3.2.2	Post-Closure Period .....	15
<b>4</b>	<b>Summary.....</b>	<b>17</b>
<b>5</b>	<b>Slope Monitoring and Mitigation.....</b>	<b>18</b>
5.1	Slope Instrumentation and Monitoring.....	18
5.1.1	Operations .....	18
5.1.2	Post-Closure.....	18

5.2 Adaptive Management and Mitigation Measures ..... 19

**6 Reporting and Documentation..... 22**

6.1 Post-Closure Stability Model Report .....22

6.2 Annual Stability Reports .....22

**7 References..... 24**

**List of Tables**

Table 1 Recommended setbacks from top crest of Open Pit to toe of mine facilities .....26

Table 2 Recommended maximum inter-ramp and overall slope angles for LOM pit.....27

Table 3 Summary of major faults at PVM .....29

Table 4 Acceptance criteria for operations period based on risk consequence .....30

Table 5 Acceptance criteria for post-closure period based on risk consequence as extracted from Table 9.9 in Read and Stacey (2009) .....31

Table 6 Results of limit equilibrium stability analysis (Extract from SRK, 2015).....31

Table 7 Schedule and Components for Supplemental Reporting.....32

**List of Figures**

Figure 1 Overlay of 2018 topography (gray) and LOM pit topography (red).....34

Figure 2 Exposed rock and material types in final pit walls under remaining life of mine to 2039..... 35

Figure 3 LOM design sectors and inter-ramp angles (IRA) .....36

Figure 4 Perspective view of LOM Open Pit and future pit lake ..... 36

Figure 5 Historical and existing unstable areas overlying current pit topography.....37

Figure 6 South Wall Slide (yellow) –1992 (top), 2003, 2018 (bottom) .....38

Figure 7 Analysis section lines used in 2015 stability analysis for LOM geology and design (SRK, 2015) .....39

Figure 8 Analysis sections 4 (top) and 5 (bottom) adjacent to NFS land (SRK, 2015)..... 40

Figure 9 Analysis sections 6 (top) and 7 (bottom) adjacent to NFS land (SRK, 2015)..... 41

Figure 10 Analysis sections 8 (top) and 9 (bottom) adjacent to NFS land (SRK, 2015).....42

## Appendices

Appendix A: Geology and Structure Cross Sections

Appendix B: Slope Monitoring Guidelines and Geotechnical Trigger Action Response Plan (March 2020)

## Abbreviations and Acronyms

ADEQ	<a href="#">Arizona Department of Environmental Quality</a>
amsl	Above mean sea level
BADCT	Best Available Demonstrated Control Technology
EIS	Environmental Impact Statement
FoS	Factor of Safety
GSI	Geological Strength Index
ft	feet
IMC	Independent Mining Consultants, Inc. of Tucson
Leach Pile	Low-Grade Ore Leach Pile
LOM	life of mine
MPO	Mine Plan of Operations
n/a or na	Not applicable
NFS	National Forest System
PoF	Probability of Failure
PVM	Pinto Valley Mine
PVMC	Pinto Valley Mining Corp.
PCCZ	Passive Containment Capture Zone
RQD	Rock Quality Designation
SRK	<a href="#">SRK Consulting (U.S.), Inc.</a>
TARP	Trigger Action Response Plan
TNF	Tonto National Forest
USFS	U.S. Department of Agriculture, Forest Service
WestLand	WestLand Resources, Inc.

# 1 Introduction

## 1.1 Purpose and Objectives

The purpose of this *Pinto Valley Mine – Pit Wall Stability and Mitigation Plan* is to organize in one document those actions that Pinto Valley Mining Corp. (PVMC) will do to monitor the Pinto Valley Mine (PVM) pit walls adjoining National Forest System (NFS) lands and mitigate stability issues during the operations and the post-closure periods. Tonto National Forest (TNF) requires this Plan to be reviewed and accepted by TNF prior to Mine Plan of Operations (MPO) (WestLand 2016).

PVMC will document and mitigate progressive failures identified in the pit walls that have the potential to increase disturbance to National Forest System (NFS) lands located outside the pit perimeter, present a threat to public health and safety, and reduce the acreage of NFS lands available for post-mine land use. The Plan follows the outline provided by TNF; it will be updated annually, or as frequently as required by unforeseen instability during the life of the project. Subsequent versions of the Plan may be reorganized to improve readability.

## 1.2 Background

Mining at PVM is conducted exclusively in the Open Pit; there is no underground mining at this site. The Open Pit and related infrastructure lie almost entirely within PVMC's private property (patented claims). There are three areas along the southern edge of the Open Pit footprint where unpatented PVMC claims on NFS lands have been cleared or used for related infrastructure. (WestLand, 2016). The future footprint of the Open Pit is expected to extend onto unpatented claims on NFS lands along the southern and eastern portions of the Open Pit. TNF requested pit wall stability monitoring and mitigation measures because there was historical slope wall creep and encroachment outside the pit onto NFS lands in the southeast quadrant of the pit and there is potential for on-going creep or slope failures during the operation and post-closure periods.

## 1.3 Pit Design and Recommended Setbacks

The life of mine (LOM) pit design and acreage of planned disturbance was submitted to TNF in the *Plan of Operations – Pinto Valley Mine* (WestLand, 2016). The design was prepared by Independent Mining Consultants, Inc. of Tucson (Capstone, 2016) using geomechanical data and slope design parameters described in *PV3 Geomechanical Data Report, Pinto Valley Mine, Miami, AZ* (SRK, 2015). With the exception of the sector of Pinal Schist in and adjacent to the South Wall Slide area, the LOM pit slopes meet the "Large Open Pit Acceptance Criteria" (Read and Stacey, 2009). These criteria are accepted internationally as best practice for designing stable pit slopes. Substantive modifications to the final pit design that could affect NFS land will be reviewed with TNF.

Figure 1 superimposes the designed final topographic contours that would result from the LOM pit expansion (red) over the 2018 pit topography (gray). The outline of the current PVM pit and remnants of the historical Castle Dome pit benches are enclosed within the black dashed boundary. Sections 1.3.1, 1.3.2, and 1.3.3 provide information on the slope design criteria, LOM pit design, and recommended setbacks of constructed facilities, respectively.

### 1.3.1 Slope Design Criteria

Rock slope angles and Factor of Safety / pit slope criteria were developed for the LOM design based on bench mapping, laboratory testing, and stability analyses performed by PVMC's geotechnical consultants. Bench-scale mapping consists of a detailed physical map and interpretation of a series of benches in a local area of the pit by a geotechnical slope stability engineer to inform the next phase of mine planning in a particular pit slope sector. The engineer notes the spacing/length/continuity of the fractures/faults, the orientation of intersecting and parallel fractures/faults, and the nature of the fracture surfaces (i.e., presence of clay gouge or slickensides, geomechanical properties of the sheared, low-strength milled fault breccia). The slope stability analyses divided the Open Pit into geotechnical domains that were combined based on similar geology, rock strength, and rock structure. The bench-scale mapping is updated as mining progresses and new information is obtained.

The slope design recommendations for each domain are based on a combination of bench-scale structure analysis for the stronger rocks supplemented with overall slope analysis for weaker rocks considering the behavior of the rock over a scale of many benches or an entire pit wall in a specific sector of the Open Pit. The weaker zones historically have been defined by lithology, a geomechanics model based on rock quality, proximity to major faults, and/or historical performance during pit operations. Inter-ramp slope angle recommendations were primarily developed using bench-slope stability analysis because the mapped and modeled through-going major faults are not adversely oriented with respect to the pit walls.

In accordance with the guidance by Read and Stacey (2009), PVMC designs the pit slopes with a Factor of Safety (FoS) of 1.2 to 1.3 for stability in all sectors of the final walls of the Open Pit including the final inter-ramp angles and overall slopes except where Pinal Schist is the dominant rock type. Individual benches and the interim pit walls /interim overall slopes are designed to meet a FoS of 1.1 and 1.2, respectively. FoS values of 1.0 or less for lower bound strength estimates are acceptable in the Pinal Schist within the Open Pit because an appropriate monitoring, control, and response plan is in place including continuous 3D Real Aperture Radar scanning of the south pit wall and monitoring of multiple survey prisms. PVMC will excavate small quantities of the Pinal Schist as part of the LOM plan. The Pinal Schist in the unmined, natural slopes in selected areas south of the Open Pit on private PVMC land and on NFS land is at the limit equilibrium conditions. This naturally weaker rock mass outcrops in the ridges and slopes below the crest of Schist Hill. The weaker rock mass is below on the hillslope (north of) the geological contact of Pinal Schist with a northeast-striking dike of Manitou Granite as mapped by Peterson and others (1951).

The general slope design criteria developed by PVMC and predecessor companies for the LOM design are described below.

1. Safe Catch Bench Widths: The geotechnical consultants performed (and will perform in the future, as needed) a catch bench design analysis based on rock fabric using Backbreak, Rockfall, or an equivalent software program.
2. Slope Design FoS: Based on previous experience, a FoS of greater than 1.2 is recommended for overall stability in most sectors for interim pit walls / pit wall slopes. Safety factors of 1.0 or less for lower bound strength estimates are allowed in the Pinal Schist because a robust monitoring, control, and response plan is in place. A FoS of greater than 1.3 is recommended for the final pit walls / overall slopes. To support this FoS design criteria, the geotechnical engineer

assessed the available geologic, hydrologic, and geotechnical data from PVM to evaluate the potential of overall slope failures involving major faults or weak rock mass.

3. Overall Slope Angle: The recommended angle in each domain of the final pit is the flattest angle produced by the catch bench, inter-ramp, or overall slope analyses based on the geomechanical properties and characteristics of faults or fault systems found in each domain.
4. Monitoring Program: The slopes in the Pinal Schist will be monitored and managed to ensure the safety of mine personnel and mobile and fixed equipment, safe access to in-pit and pit perimeter roads, as needed, and to prevent encroachment on NFS land. Slopes in the Pinal Schist, a relatively weak rock type, have a history of displacement, and the impact on operational activities must be considered. PVMC has safely maintained operational activities with displacing slopes using a range of mitigating controls based on visual observation and a digital slope monitoring program.
5. Step Outs: Step outs areas are incorporated in the PVM design to provide sufficient width for safe passage of haul trucks traveling towards each other in pit ramps and access roads, for overall slopes that are catch-bench controlled, and at the contact below the east sector. Step outs are areas within a pit design where there is an expanded distance from the toe of a mine bench and the crest of the underlying bench relative to the default distance used in the pit design. The step-out contours show as broader, more gentle contours on the sector map in Figure 3. Step outs are also recommended in the northeast and southwest sectors to reduce the overall slope angle.
6. Reduce Pore Pressures on Pit Walls: Pit dewatering is implemented to depressurize the slopes and to remove water accumulating in the bottom of the pit when the pit bottom area is actively mined. The pit dewatering is accomplished by use of pumped wells along the pit rim and or other location within the pit, horizontal gravity drain holes that drilled into the pit walls or at the toes of unstable area, and natural dewatering through seeps. Seeps are estimated to contribute approximately 300 gpm to the Open Pit. Most of the major seeps in the PVM Open Pit daylight from fractures in the Ruin Granite in the north pit wall immediately below the overlying Low-grade Ore Leaching Piles (Leach Pile) materials. Monitoring individual seeps and flow rates is not feasible because the seep locations typically daylight in cracks in the steep pit walls, change daily and/or seasonally in response to changes in the Leach Pile ore and raffinate applied in specific areas and/or to local precipitation events, and are mined out as the pit advances. New seeps develop as cracks and fractures are exposed. PVMC annually submits a demonstration of the containment capture zone around the Open Pit to Arizona Department of Environmental Quality (ADEQ). The containment capture zone is an actively managed system during operations. It will be a passive containment capture zone (PCCZ) during the post-closure period because the pit dewatering system will be discontinued and the post-closure pit lake will be a terminal sink with permanent inward hydraulic gradient towards the Open Pit (SRK, 2019).

### 1.3.2 Life-of-Mine Pit Design

The pit designs (past, current, and future) were/will be prepared by experienced, professional mining engineers under the supervision of the PVMC General Manager and/or by independent mine design firms (such as Independent Mining Consultants, Inc.) contracted by and under the supervision of the PVMC General Manager or equivalent PVMC mine engineering specialist. The associated pit slope stability analyses were (and will continue to be) performed by experienced geotechnical engineers



contracted to PVMC and working as registered professional engineers in the State of Arizona for engineering firms in good standing with the Arizona Board of Technical Registration.

The planned contours (red) for the remaining LOM are shown overlying the current pit contours (gray) as of March 2018 in Figure 1. The vertical and horizontal pit excavation will continue until approximately mid-year 2038. The horizontal pushbacks will primarily focus on extending the north and eastern pit walls. At the end of 2039, elevation of the deepest part of the Open Pit will be approximately 2,240 ft above mean sea level (amsl). A portion of the historical leaching materials in the Leach Pile will be excavated during the north pushback. Any substantive modifications to the final pit design that will affect NFS land will be reviewed with the Forest Service.

With the exception of limited sectors of Pinal Schist in the south wall, the pit design meets or exceeds a FoS of 1.2 to 1.3. The calculations for FoS are based on RQD data/models, the PVM geology block model, estimated piezometric surfaces around the Open Pit, site-experience with specific pit-wall sectors, and two-dimensional (2D) limit-equilibrium stability models (SRK, 2015).

### 1.3.3 Recommended Setbacks for Leaching and Waste Rock Facilities

The planned slope gradients under the LOM plan (Figure 1, Figure 2) are designed and engineered to meet stability criteria specified in *Best Available Demonstrated Control Technology (BADCT) – Mining Guidance* (ADEQ, 2004) established by ADEQ. BADCT stability criteria applies to the construction of PVMC's existing and planned facilities on private property along the pit rim during the remaining pit slope excavation. The existing and planned facilities adjacent to the Open Pit have been analyzed to determine stability, as documented in respective reports submitted to ADEQ. The designs for the waste rock dumps, Leach Pile, and Inert Limestone Stockpile meet the BADCT FoS for operations conditions and meet the long-term FoS stability criteria for the post-closure condition.

Table 1 provides the recommended setback distances from the edge of the top bench crest of the Open Pit for existing and planned facilities that are within or adjoin the Open Pit. The setback (offset) distances range from 0 ft to 250 ft (SRK, 2018b). The LOM plan will intersect and mine out portions of certain facilities on private PVMC property prior to final site-wide closure and reclamation. These facilities include portions of the future decommissioned Leach Pile in the north wall and the Main Dump overlying the Leach Pile in the north wall.

### 1.3.4 Recommended Maximum Inter-Ramp Slope Angles for the LOM Pit

Recommended bench and inter-ramp slope angles were developed for different sectors of the LOM pit as shown in Figure 3. The slope design parameters used for the LOM pit are listed in Table 2.

## 2 Geotechnical Conditions

This section summarizes the methods for the geotechnical characterization completed at PVM (Section 2.1), historical and existing slope failures in the Open Pit (Section 2.2), and the existing slope monitoring system (Section 2.3).

### 2.1 Geotechnical Characterization

Sufficient data exist from geotechnical mapping, core logging, and laboratory testing to perform pit wall stability analyses of the LOM pit design. PVMC and predecessor companies have performed periodic geotechnical characterization of the pit slopes and benches and stability assessments since the mid-1980s as the pushbacks gradually deepened and widened the Open Pit and exposed new rock masses and structures in the pit walls. Characterization activities included (and will continue to include as needed):

- Surface mapping the geology and faults (i.e., length/width/thickness/dip) exposed in the pit,
- Geotechnical cell mapping of joints, fractures, and faults on representative benches,
- Field checks of slope performance in various areas, and
- Subsurface investigation with core drilling to extract core for:
  - Logging of core recovery percentages,
  - Logging for Rock Quality Designation (RQD), and
  - Laboratory testing.

High (good) recovery in drill core (i.e., core recovered as a percentage of core drilled) can indicate the presence of hard, competent rock in the pit wall while low (poor) core recovery can indicate unconsolidated, weak, weathered, and/or faulted and fractured rock. RQD is a measure of the quality and degree of jointing or fracturing in a rock measured in percentages. RQDs of 75% or more indicate high-quality, hard, competent rock while RQDs less than 50% typically indicate low-quality, weathered, highly fractured, or other weak incompetent rock. The RQD drillhole data have been compiled into three-dimensional (3D) models informing the Mine Department and PVMC geotechnical consultants of the bulk rock mass properties in specific sectors of the pit. Geotechnical laboratory testing typically includes uniaxial compression tests, rock density, and small-scale direct shear strength testing of materials taken from core and surface samples along geological discontinuities (i.e., rock foliation, fault gouge).

#### 2.1.1 Geotechnical Domains

For slope design purposes, the Open Pit is divided into geotechnical domains or design sectors. The domains are regions where geology, rock strength, and rock structure are considered similar enough that they can be combined for slope analysis. How rock masses are combined or further divided depends on location with respect to major fault zones, which are designated as shear zone sectors. The PVMC Mine Department maintains 3D geology and mining models and updates them with new geology and geotechnical drilling data, as available.

## 2.1.2 Geological Structures

Geological structures or faults are surfaces along which movement has occurred. The major faults in the LOM pit, shown with blue traces in Figure 2, are typically zones of broken, milled rock of variable thickness and extent. The major faults are dominantly post-mineralization (i.e., occurred after the formation of the PVM porphyry copper deposit) and have dismembered the deposit as summarized in Table 3. Appendix A provides representative cross sections with the existing and planned LOM pit topography showing the rock type, major structures, and the water level surface along those profiles. Note that the lower physical limits of the faults are shown for convenience as a single dark blue trace on the cross sections and as a fault plane in the 3D geology model. The hanging wall (upper part) of the faults, however, typically express themselves as zones of broken rock 50 to 100 feet in thickness in broken rock.

## 2.1.3 Hydrogeologic Conditions During Mining and Post-Closure Periods

The Open Pit is excavated primarily in relatively impermeable Ruin Granite, with lesser volumes of other low-permeability formations (monzonite, Pinal Schist, and diabase) (SRK, 2018a). Water inflows of 200 to 300 gpm were historically observed in the fractured upper zones during early pit development. The inflows were estimated to be approximately 100 gpm from fracture flow and seeps in the pit walls during a period of care and maintenance from 2011 to 2012. The long-term average rate of inflow to the Open Pit during operations is estimated to be approximately 300 gpm. The water is collected in a pit lake at the bottom of the Open Pit and pumped for reuse in the plant facilities.

At the end of the mine life, pit dewatering will cease, and a permanent lake will form within the pit on private PVMC property as illustrated in Figure 4. The pit lake surface is predicted to rise to approximately 2,942 ft amsl, which is 557 ft below the physical spillover elevation of 3,499 ft amsl and 378 ft below the model-simulated flow-through elevation of 3,320 ft amsl at which elevation passive hydraulic containment would be lost.

The future permanent pit lake will contain groundwater inflows, precipitation, stormwater runoff, and storage of the Leach Pile draindown. Evaporative losses will exceed inflows thereby ensuring that the pit lake will remain below 3,320 ft elevation with a continued inward hydraulic gradient in effect [see SRK (2019) for details]. PVMC's Aquifer Protection Permit (APP) requires the pit lake level to be maintained at a minimum of 50 ft below the modeled flow-through elevation or at an elevation not to exceed 3,270 ft amsl. Public access to the Open Pit will be restricted through use of fencing and other institutional controls during the post-closure period, and the mine staff will monitor the rate of pit lake recovery.

## 2.2 Review of Historical and Existing Slope Failures and Creep in the Pit

PVMC and predecessor companies have successfully managed several instabilities through the mine's history that have been used to assist in the development of material properties and pit slope designs for parts of the pit that are adjacent to NFS land (SRK, 2015). Rock mass strength estimates for the Pinal Schist, Whitetail Conglomerate, and Ruin Granite are in part based on back analysis of the historical and existing instabilities described in Sections 2.2.1 and 2.2.2.

Figure 5 shows the approximate location of the major faults and the historical and existing unstable areas projected onto the current pit topography map. Note that some historical slide areas (1) were

subsequently mined out (i.e., West Wall Failure, Castle Dome Slide), and/or (2) will be mined out during the LOM (Bummer Fault Slide). The geology of the current pit walls is similar to what will be exposed in the LOM pit walls as illustrated in Figure 2. For example, the west wall is already at its final configuration, and the north and east walls are currently mining the same materials in the same general bench heights as what is depicted in Figure 2. This figure highlights the slide zones (i.e., South Wall Slide, Castle Dome Slide) and Schist Hill Creep Monitoring Zone adjacent to NFS land.

### 2.2.1 Historical Slope Failures

The historical slides (Schist Hill Gravity Slide, West Wall Failure, Bummer Fault Slide, and Castle Dome Slide) are described below.

- **Schist Hill Gravity Slide (also referred to as Pinal Schist Gravity Slide) (1985):**
  - The Schist Hill Gravity Slide was interpreted by PVM geologists to be a reactivation of a paleo-landslide mass of Pinal Schist that daylighted in the upper pit benches from approximately 4,200 to 4,400 ft amsl. The mass overlies an area bounded by the regional Gold Gulch fault on the east and West End fault on the west. The mass was unstable during pit pushback development especially under saturated conditions. The failure mechanism appeared to be a basal failure plane interpreted as shallow-dipping intersecting fault planes that formed a basal circular arc beneath the slide mass. One oriented core hole was drilled in this area in 1985 and limited rock fabric mapping was conducted to revise the slope angle recommendations for this area.
  - The thickness (depth) of the paleo-landslide materials is estimated to be less than 200 feet. This depth is based on the expression in the pit benches over 200 feet in height, stability analysis results, and drill data.
  - Mitigation steps during the time the mass was mined prior to 1990 was to use berms on 25 to 35-foot wide catch benches, monitor groundwater levels nearby and dewater the slopes, and design a flatter interramp slope angle in this area.
  - This historical slide area was dominantly on private PVMC property north of NFS land on the south wall of the Open Pit; less than 1 acre of encroachment occurred on NFS land.
- **West Wall Failure (1994-1996):**
  - This failure occurred in a zone of weak, sheared rock in southeast-center of the west pit wall above the Gold Gulch fault and West End fault. This area was unstable as mining advanced in the mid-1990s. The sheared rock mass was a mix of brecciated granodiorite and unconsolidated Whitetail Conglomerate. The failure was attributed to the weak, soil-like properties of the highly fractured zone between two major faults.
  - The width of the sheared zone between the Gold Gulch fault and West End fault ranges from approximately 400 to 1,000 feet, with the width expanding from south to north along the west wall. The faults dip approximately 60 degrees to the west-southwest and the depth of this shear zone has been documented to be greater than 1,000 feet below surface owing to the regional nature of the Gold Gulch fault system.
  - Mitigation steps in the mid-1990s were to flatten the interramp slope angle in the Gold Gulch fault zone to minimize creep and to protect the only access ramp into the west side of the Open Pit. The specific failure area is no longer visible because it was mined out in the late-1990s with no further mining planned in the west wall.

- This historical slide area is on private PVMC property on the west wall of the Open Pit. There was no encroachment on NFS land.
- **Bummer Fault Slide (2008):**
  - A triangular, wedge-shaped failure occurred in Ruin Granite adjacent to the brecciated Bummer fault in areas that were at their then-current final pushback. The wedge occurred in an area overlying a weak zone caused by the intersection of the southeast-dipping Bummer fault and an unnamed southwest-dipping fault.
  - Mitigation steps at the time were to use berms with 25- to 35-foot wide catch benches. Remnants of this wedge failure, visible in the existing north pit wall, will be mined out in the LOM plan.
  - This historical slide is on private PVMC property approximately 1 mile due west of NFS land. There was no encroachment on NFS land.
- **Castle Dome Slide (2015)**
  - In September 2015, tension cracks were observed in pit benches in the southeast pit area near the former Castle Dome Mill. The cracks were above 4,040 feet amsl and affected the existing haul road in a portion of the Open Pit immediately adjoining NFS land to the south. Stormwater runoff produced rilling in the pit wall contributing to the cracks and creep.
  - Mitigation steps were to re-route stormwater and de-weight the slope by removing material. The unstable ground condition was reported to TNF and a remediation plan was executed to remove approximately 415,000 tons of material (WestLand, 2016).
  - The affected area is dominantly on PVMC private property. Approximately 0.5 acres on PVMC's unpatented claims on NFS land were impacted.

## 2.2.2 Current Slope Failures and Creep

Some erosion, bench crest raveling, creep, and minor sloughing is expected in the pit walls during remaining LOM and the post-closure period because the pit walls are exposed to on-going physical processes related to wind erosion, freeze/thaw, and precipitation. Stormwater runoff from the benches within the Open Pit can cause localized rilling and raveling. Continued creep displacement may occur in the Pinal Schist, Ruin Granite, and granodiorite on the south side of the Open Pit adjacent to NFS land. The Pinal Schist in natural outcrops and slopes on NFS land south of the Open Pit will remain at limit equilibrium conditions and be subjected to creep deformation.

Creep is defined in the AGI *Glossary of Geology* as a slow, imperceptible downslope movement of mineral, rock, and soil particles under gravity. It is also a continuously increasing, slow deformation (strain failure) of a rock mass that is typically observed over months to years. The benches and natural slopes in Pinal Schist, approximately outlined on both private PVMC and NFS land and labeled in Figure 5 as “Schist Hill Creep Monitoring Zone,” are monitored for signs of failure and creep. Minor sloughing and displacements are addressed when they occur. Areas of current slope failure and creep are described below.

- **South Wall Slide Failures (also referred to as South Hill Slide)** (see Figure 5 and the time-series photographs in Figure 6) (1992 to present):
  - This is failure of highly sheared and weathered Pinal Schist between the west-dipping regional Gold Gulch fault and West End fault at bench elevations between 3,500 and 4,000 ft amsl. This

active creep area now subsumes an area of earlier exposed portions of the South Wall Slide. The two major faults and other sub-parallel unnamed structures created a shear zone of milled, highly fractured weak rock fabric. Failures from the extreme far southwest wall progressed into the current South Wall slide area.

- Mitigation steps were to regrade the area to a 27° slope in 2007. The slide continues to displace in a steady state creep.
- Analysis Sections 8 and 9 are briefly summarized in Section 3.2.1 as extracted from SRK (2015).
- The slide is on private PVMC property 0.11 miles northwest of the boundary with NFS land. There is no encroachment on NFS land.

- **Schist Hill Creep Monitoring Zone**

- The zone broadly outlined in Figure 5 includes: (1) historically mined benches, an active pit perimeter access road, and a ramp access road within the Open Pit, (2) prior disturbance on private PVMC property and NFS land related to the 1985 Schist Hill Gravity Slide, and (3) natural slopes on private PVMC and NFS land south-southeast of the pit rim.
- The relatively weak Pinal Schist rock mass outlined in Figure 5 is bounded to the north-northwest by the South fault and to the south-southeast by the contact of the schist with a northeast-striking granitic dike (Manitou Granite) designated by a red stippled pattern on the USGS geological map (Peterson, 1951; extracted in Figure 7).
- Evidence of Creep: Slight accelerations in creep were observed within the Open Pit in localized areas of the historical Schist Hill Slide likely owing to heavy rainfall in both March and December of 2019.
- Mitigation steps taken were to install additional horizontal drains near the base of observed creep to depressurize the local slope area on private PVMC property.
- Monitoring of this area by PVMC and its geotechnical consultants for signs of creep is ongoing. Creep monitoring results and mitigation steps taken during the year will be included in the annual report provided to TNF.

## 2.3 Existing Slope Monitoring System

PVMC has safely maintained operational activities with displacing or creeping slopes using a range of mitigating controls based on visual observation, pit slope dewatering (depressurization), and a slope monitoring program. The Mine Department monitors dozens of slope prisms on a 24-hour scanning sequence and uses two 3D Real Aperture radar units to scan the highwalls on a 24-hour basis. Aerial images of the walls are presented in Appendix B.

In active mining areas, the slope monitoring of PVM benches and highwalls includes one or more of the following: visual inspections, extensometers, crack mapping, and prism surveys to assess the presence of slope movement and the velocity of movement. The Mine Department reviews piezometer readings to assess the pore pressure adjacent to the pit walls. The monitoring activities vary in frequency depending on the rock type (i.e., soils / Whitetail Conglomerate versus hard rock like Ruin Granite, and location in old slide areas). The monitoring activities also vary according to recorded slope movement velocities in inches/day and inverse velocities (day/inch) as listed in Table 2 of Appendix B. For example, extensometers when used in active mining areas in Ruin Granite and diabase are checked twice daily, daily, and/or weekly according to slope movement velocities

ranging from >2 inches/day to <0.1 inches/day. Radar and human spotters are used where needed based on risk assessment.

Geotechnical alarm settings have been established by the Mine Department based on the results of radar scanning of various zones in the Open Pit (i.e., Zones 1 through 8 and Zones A through H). The zones are delineated approximately on aerial images in Appendix B. The alarm urgency level is based on inches of deforming movement in a 24-hour period and on the velocity measured over a 4- to 6-hour period.

A Geotechnical Trigger Action Response Plan (TARP) has been established for the pit wall slopes (see Table 7 of Appendix B). The TARP specifies actions to be taken by PVMC's Geotechnical Engineer, Mine Department / Technical Services Manager, Mine Manager, and General Manager to investigate displacements of various velocities and take actions to mitigate safety hazards including modifying the mine plan as needed to eliminate and/or reduce the impact of slope failures. The slope monitoring procedures and TARPs are reviewed annually or as needed on a more frequent basis.

# 3 Stability Evaluation

This section describes the stability evaluation that was performed in 2015 to support the LOM design submitted to TNF (WestLand, 2016) and to assess the stability of the PVM pit walls abutting NFS lands.

## 3.1 Stability Analysis

To assess the stability of the LOM design and pit slopes, PVMC's geotechnical engineering consultant prepared a 2D limit-equilibrium slope stability model in 2015 using Slide 6.0 (version 6029) software. Spencer's method of slices was used to calculate the FoS for the design sectors shown in Figure 7. Eleven cross sections were analyzed by SRK assuming plain strain conditions. These methods assume that the shear strengths of the materials along the critical surface are governed by modified Hoek-Brown or linear Mohr-Coulomb strength envelopes.

Both circular and non-circular searches were performed based on a path search algorithm. The path was defined to limit the search from the toe of the slope to the crest. In materials such as the Whitetail Conglomerate and in the Pinal Schist, the slope search in some cases identified critical surfaces internal to these units. The critical surfaces were optimized before a FoS was reported.

### 3.1.1 Input Parameters and Assumptions

A summary of the input parameters for the 2015 2D limit-equilibrium analysis is listed below:

- LOM final pit design provided by PVMC and IMC;
- Geology from the PVM geology block model;
- Modified Hoek-Brown (1997) strength parameters calculated using:
  - Values ( $m_i$ ) determined from analysis of triaxial rock strength testing data from the rock strength testing programs completed at PVM;
  - 30% percent cumulative less than the Geological Strength Index (GSI) value; and
  - A damage factor of  $D = 0.5$ .
- A groundwater potentiometric surface was estimated on each section based on the results of annual groundwater level monitoring completed by AJAX Ltd on behalf of PVMC.

The GSI strength parameters for 30% less than cumulative distribution, using a modified Hoek-Brown envelope and a damage factor of 0.5, are roughly equivalent to the CNI strength method (Call and others., 2000) developed using the RQD method. The CNI method assumes a reduction factor of 50% of the calculated rock mass cohesion (Call and others, 2000). The CNI RQD based strength method has been used historically at PVM.

### 3.1.2 Pore Pressure Conditions

PVM pit slopes have been dewatered and depressurized primarily through use of horizontal drains that are drilled as the walls are pushed back. PVMC has also occasionally used vertical wells that pump groundwater from below the bottom of the pit. Stability modeling at PVM is calibrated to



replicate current conditions assuming dewatered conditions and using measured and estimated groundwater (piezometric) surfaces as documented in the PVMC geotechnical consultant reports.

### 3.1.3 Acceptance Criteria

This section addresses the acceptance criteria for assessing the stability of PVMC's pit slope designs during operations and the post-closure period. The acceptance criteria are based on the certainty of the available data at the time of the design and the design level.

The PVMC Mine Department has decades of operations knowledge of the geomechanical properties of specific rock types and fault zones under various excavation rates, variability in rock quality caused by alteration/oxidation/weathering profiles in the pit, and under a range of freeze/thaw conditions and precipitation events. Excavation has proceeded from higher to lower elevations progressively widening and deepening specific bench areas or pit slope sectors, exposing fresh rock. The certainty about the strength properties of specific rock types has increased over the decades through extensive geotechnical drilling/testing programs as well as through daily observations as miners blasted, excavated, crushed, and milled the rock for processing and as they monitored the active and inactive pit walls for potential failures.

The certainty about the behavior of certain slopes (i.e., consistently weak in the South Wall Slide and within the Schist Hill Creep Monitoring Zone, competent/hard rock in other zones) is factored into the mine design based on a proven, tested track record related to the geomechanical properties of specific rock types and the behavior of faults and weaker zones. The operators also gained valuable insight on the pit wall characteristics and behavior during the long care-and maintenance periods from February 1998 through October 2007 and from January 2009 through February 2012 during which time no active mining occurred, pit slope dewatering ceased, rilling occurred in some areas where less effective drainage controls were in place, and stormwater accumulated in the Open Pit. Uncertainty is reduced through decades of operational experience although never completely eliminated. The engineering design and acceptance criteria for PVMC's LOM plan relies on operational understanding of the site geomechanical properties and is also based on geotechnical and mine engineering judgement.

The acceptance criteria account for safety, social, economic, and industrial best practices. The Slope Acceptance Criteria generally follow industry accepted practice and after the methods and procedures outlined in *Guidelines for Open Pit Slope Stability* (Read and Stacey, 2009). The provided acceptance criteria for safety factors and probability of failure (PoF) are based on PVMC's experience in accordance with the consequences of potential ground failures. These criteria may change as the mine excavation and design advances owing to additional data being collected in the future and the impact of consequences are assessed using proper risk assessment methodologies. The acceptance criteria listed in this section are consistent with what has been used historically at PVM.

### Operations Period

Slope failures in open pit mines rarely develop instantaneously; rather they tend to develop gradually over time and can be assessed by monitoring. Therefore, determination of a sufficient margin of safety may not be as simple as selecting an appropriate value for safety factors or a PoF. There needs to be some level of geomechanical knowledge in identifying potential failure modes and

confidence in the selected input data used for analysis, as well as an understanding of the way specific failures progress over time.

Frequently safety factors computed from stability analyses are defined using average input strength values. However, in some cases lower-bound input values are selected to compensate for low confidence levels in certain input parameters. The PoF must also be considered in terms of the Reliability Index. The PoF is not used for design purposes in cases where the Reliability Index is low. In those situations, a sensitivity analysis is carried out instead to determine design acceptability.

PVMC's acceptance criteria based on criteria published by Read and Stacey (2009), Priest and Brown (1983) and Steffan and others (2008) includes a description of potential failure consequences and comments on failure at different scales. This range of values was used to assess the stability of the pit slopes during operations. The acceptance criteria presented in Table 4 is guidance that PVMC considered in terms of the specific economical and safety risk profiles for the LOM design submitted to TNF.

Kinematic analysis is used for optimization of bench face angles (also known as batter face angles). Batter walls are walls that have a receding, rather than overhanging, slope. A PoF of 10% to 20% is recommended for bench face design to control potential smaller bench-scale instability. As a part of the process of using this PoF, the quantity of potential spillage is calculated in each case, to ensure that berm capacity is sufficient to contain any spillage material.

## Post-Closure Period

Geotechnical considerations for open pit closure in the global industry reference Chapter 14: Open Pit Closure (van Zyl, 2009) of *Guidelines for Open Pit Slope Design* (Read and Stacey, 2009). For closure, the geotechnical literature is not explicit with respect to the criteria for acceptable FoS. Table 9.9 of *Guidelines for Open Pit Slope Design* (Read and Stacey, 2009), reproduced here as Table 5, suggests target minimum FoS in terms of the performance of pit slopes. The recommended FoS are based on the potential consequences of a pit slope failure under static conditions.

In most cases, pit walls carrying major mine infrastructure are likely to present the most appropriate case for pit closure for which a FoS = 1.5 is used at the minimum design criterion. A FoS = 2.0 would be more applicable where pit walls are adjacent to public infrastructure (de Bruyn 2019). Note that although there are no mine-critical or public infrastructure facilities situated above the PVM pit walls, there is a potential for continued raveling during the remaining LOM to the pit walls immediately adjoining the southern portions of the Open Pit on private property particularly in the historical South Wall Slide area.

The probability of a deep-seated pit wall failure extending to the pit bottom occurring during the LOM and the post-closure periods such that it would cause unplanned disturbance to NFS land is considered to be low. However creep and continued movement of Pinal Schist within the Schist Hill Creep Monitoring Zone, including in previously mined areas and on native slopes extending onto NFS land is considered likely.

Appropriate design acceptance criteria for pit slope failure for closure where pit slopes are not adjacent to public areas or infrastructure could be defined as follows:

- Where a predicted (analyzed) failure zone intersects adjacent sensitive infrastructure elements or the minimum 10-m setback distance therefrom, a FoS > 1.5 should be achieved under static

condition and a FoS of  $>1.1$  should be achieved under dynamic conditions (taken as the upper bound of the FoS range for high risk for slope stability in Table 5).

- Where a predicted failure zone is of limited extent such that it does not intersect any sensitive infrastructure elements or the minimum 10-m standoff distance therefrom, then the FoS is not important (i.e., failure within this zone is considered to be acceptable over the long term (de Bruyn and others, 2019). This condition is applicable to the pit slopes at PVM.

## 3.2 Results

### 3.2.1 Mining Period

The results of the stability analysis for walls adjacent to NFS land are summarized below as extracted from the SRK (2015) report submitted to TNF. Figure 7 shows the analysis section locations for the sectors bordering NFS land, the LOM pit contours, and the LOM pit geology and faults. Table 6 tabulates the limit equilibrium results for the analyzed sections.

Discussion of the individual results by relevant section follow below. Analysis Section 4 of the 2015 study (SRK, 2015) addresses the stability of the eastern pushback of the Open Pit for the LOM design. Sections 5 through 8 were prepared to analyze various sectors along the southern portion of the Open Pit. The results are presented for a full depressurization case where no groundwater is modeled and for an estimated groundwater surface. The estimated groundwater surface assumes some level of depressurization through horizontal drains or pump wells.

The results for Analysis Sections 4, 5, 6, and 7-Lower show these sections meet a FoS  $>1.5$ . The results for Analysis Sections 7-Upper and 8 meet the minimum FoS of 1.0 developed for Pinal Schist. The results meet the acceptance criteria for the operations period.

#### Section 4: East Wall -W-NW Profile

This section transects Ruin Granite at the bottom of the pit, the Jewel Hill fault, and crosses into diabase in the upper pit benches Figure 8. The critical surface would daylight at the 3,400 ft amsl level in Ruin Granite with the remainder of the surface in granodiorite in the upper pit benches. The FoS for this section is approximately 2.06, and meets acceptance criteria FoS for operations specified in Table 4.

#### Section 5: Southern Pit Wall, NW-SE Profile

This section is primarily in Ruin Granite with a weaker dike of granodiorite. The critical surface extends from the 2,575 elevation to behind the crest at 4,040 ft amsl Figure 8. The FoS for this surface is 1.61.

#### Section 6: Southern Pit Wall, NW-SE Profile

This section has a slightly lower FoS because it is 50 percent Ruin Granite (lower pit benches) and 50 percent granodiorite (upper pit benches) (Figure 9). The critical surface extends from the 2,575 elevation to behind the crest at 4,040 ft amsl. The FoS for this surface is 1.60.

#### Section 7: Southern Pit Wall, NW-SE Profile

This section crosscuts Ruin Granite from the base of the pit at 2,375 ft amsl to the crest at Schist Hill and then transitions across the South Hill fault to Pinal Schist (Figure 9). The slopes are assumed to

be at limit equilibrium FoS of 1.00 based on a previous instability in 1985. No additional mining is planned in this part of the pit. The overall slope FoS is 1.412.

#### Section 8: Southern Pit Wall, N-S Profile

Section 8 extends from the South Wall Slide area, at limit equilibrium (FoS = 1.0), crosses a series of faults related to the Gold Gulch and West End fault system, and extends in Ruin Granite to the toe. This section is confined. The South Wall Slide, in sheared, and faulted Pinal Schist, is expected to continue to displace at its current angle of 27°. No additional mining takes place in the Pinal Schist as a part of the LOM. Figure 10 illustrates the critical surface extending from behind the South Hill fault to the toe of the PV3 design at the 2,375 ft level. The FoS on the overall slope is 1.30.

#### Section 9: Southern Pit Wall, SW-NE Profile

Section 9 extends from the basalt, Gila and Whitetail conglomerates in the upper benches, across the Gold Gulch fault system, and into Ruin Granite in lower benches. This is the approximate alignment of the critical section in the PV2 design. Based on a recent piezometric surface measurement, this area is interpreted to be depressurized above the critical surface, yielding a FoS of 1.26 as illustrated in Figure 10.

### 3.2.2 Post-Closure Period

The post-closure period is defined as 100 years after the end of mining and processing (i.e., mid-year 2039 to mid-year 2139). One hundred years was chosen to be consistent with the predictions and descriptions in other models and plans. The pit lake will take approximately 500 years to reach a steady state condition, but the most rapid infilling occurs in the first 60 to 100 years because the size of the Open Pit is limited at the bottom with less surface area for evaporation [see Figure 77 of SRK (2019)]. The pit lake development then slows because evaporation from the large lake surface is the dominant factor.

Note there are few publicly available studies regarding long-term rock mass degradation in open pits. The *Guidelines for Open Pit Slope Design* (Read and Stacy, 2009) recommends review of several key considerations for the long-term after closure, many of these relating to changes that are expected to occur in the rock mass and boundary conditions that influence the geotechnical stability of the pit walls in the medium and long-term. The geotechnical stability of the pit walls after closure are mainly influenced by the following factors (de Bruyn and others, 2019):

- Weathering (deterioration from exposure) and slaking;
- Shear strength changes in-pit wall materials resulting from reduction in intact material strength and reduction in shear strength of fractures and major structures (faults and shears);
- Rock mass degradation as a result of stresses;
- Stress relief – resulting in instability and/or raveling;
- Hydrogeological changes (e.g. re-pressurization of slopes due to cessation of dewatering and pit lake development);
- Seismicity;
- Loss/deterioration of controlled surface drainage, leading to re-pressurization and/or erosion; and
- The presence of voids from underground mining (if present).

The degradation of the rock mass that is likely to occur over time is difficult to quantify. Assumptions must be based largely on field or laboratory testing (often of limited applicability for the long-term), current geotechnical properties, limited case studies, past experience at PVM observing deterioration, extrapolation and engineering judgement. In short, assumptions concerning degradation are subjective, and there are few published examples that can be confidently followed.

The overall effect is that the pit walls may become distressed and ravel or fail over time, and in extreme cases major failures of the pit walls can occur. The failed material ('talus') may accumulate on benches or in the pit lake, possibly creating a wave in the pit lake. Identification of principles for long-term deterioration and talus estimation is a challenge, and the approaches utilized provide only indicative results/ranges which can be used to guide sensitivity analyses. Industry accepted detailed empirical or deterministic approaches applicable to the estimation of talus volumes have not been established. Note that the PVM Open Pit is expected to contain any potential wave that may occur during the post-closure period. As mentioned in Section 2.1.3, the steady state pit lake level is predicted to rise to approximately 2,942 ft amsl, which is 557 ft below the physical spillover elevation of 3,499 ft amsl.

To attempt to best estimate the deterioration of pit slopes, engineering judgement is used to identify the likely deterioration in the various components contributing to rock mass strength, including the intact strength, the joint properties and the joint spacing. These can be assessed using weathering, durability and GSI (which evaluates rock mass blockiness and fracture conditions) data available for the rock mass at the time of pit design – to provide amended inputs for stability assessment. Weak or weathered rock is likely to deteriorate more rapidly than strong, unweathered, good quality rock mass so this is considered in the downgrading of individual factors. The presence of groundwater, such as a recovering pit lake, also plays a role.

## 4 Summary

PVMC developed acceptance criteria modified after Read and Stacey (2009), Priest and Brown (1983), Steffen and others (2008) to establish FoS for the 2016 LOM design that was presented to TNF in the PVM Mine Plan of Operations (WestLand 2016). The results of the 2015 2D equilibrium stability analysis for the LOM design indicated that the FoS met the acceptance criteria established for various sectors of the Open Pit.

Pit wall tension cracks, slope creep, and potential failures or movements may occur during the remaining LOM pit excavation and during the post-closure period in response to factors such as weathering, reduction in intact material strength and shear strength along faults and shears, rock mass degradation as a result of stress and erosion, stress relief that causing raveling, changes in slope pressurization or pit lake development, seismicity, loss of stormwater drainage control causing gullying or erosion.

The most active area of long-term slope movement—the South Wall Slide is on private PVMC property approximately 0.11 miles north-northwest of NFS land as outlined in the 2018 image in Figure 4. Creep and continued movement of Pinal Schist including previously mined areas and native slopes within the Schist Hill Creep Monitoring Zone (Figure 5) are considered likely due to the relatively weak rock type.

PVMC's existing pit slope monitoring and management system is an adaptive program that enables the Mine Department to identify, track, mitigate, and respond to tension cracks, slope creep / sloughing, and slope failures within the Open Pit including in the upper benches adjoining NFS land. There is no uncontrolled public access to the Open Pit, and institutional measures (fencing, gates, signage) will be implemented at closure to ensure public safety.

# 5 Slope Monitoring and Mitigation

## 5.1 Slope Instrumentation and Monitoring

The slope monitoring program at PVM is a core program within the Mine Department to ensure safe, efficient, and cost-effective resource extraction. The monitoring frequency, the location of specific monitoring components such as prisms or extensometers, and the level of monitoring activity are subject to frequent internal review depending on site conditions and the status of pit excavation. A slope stability monitoring program will be in effect during the remaining LOM and the post-closure period and the monitoring components will be tailored, as relevant, to the expected and observed conditions in the active, inactive, and future closed status of the pit walls.

### 5.1.1 Operations

PVMC's existing slope instrumentation and monitoring system is described in Section 2.3. The current on-going program of visual inspections, crack mapping, prism surveys, piezometers, and ground probe radar surveys, and the occasional use of extensometers, when appropriate, is anticipated to continue throughout the remaining LOM with the adoption of technology upgrades and instrumentation/equipment improvements as relevant.

### 5.1.2 Post-Closure

After mine closure, stormwater and other engineering controls will be put in place to minimize erosion and enhance stability in the land immediately adjacent to the pit rim while natural processes will eventually modify and dominate the topography and features within the pit. Weathering and erosion, with associated sloughing and raveling, will occur in benches that are exposed to the atmosphere, precipitation, freeze/thaw, and other natural processes. Rock mass degradation at many scales may occur in the portion of the pit wall contacted by the rising pit lake. The pit lake is expected to be contained within the Open Pit despite any (minor to substantial) pit wall sloughing or failures that may occur.

The post-closure monitoring program will focus on identifying and mitigating pit slope stability impacts that may endanger public health and safety or that may cause unplanned disturbance to NFS land. Figure 2 shows the planned final mined pit geometry, NFS land boundary, the rock and material types that will be exposed in the LOM pit walls, and the limits of known or suspected areas adjacent to NFS land that may be potentially unstable or marginally stable during the post-closure period. The post-closure pit slope monitoring activities described below are assumed to occur for the first 30 years following mine cessation; the types and duration of the inspections may be modified depending on actual pit conditions and stability trends observed during this period.

Pit access will be restricted during the post-closure period with controlled access to the entire mine site and fencing and gates installed around the Open Pit. The perimeter road around the Open Pit will enable direct inspections of the closed, reclaimed facilities (i.e., waste rock dumps, tailings,

Leach Pile, Inert Limestone Stockpile) adjacent to the pit crest and of the condition of the pit walls in the upper benches. A minimum of one main ramp road will be accessible for many years for site inspections into the Open Pit. The internal pit access will become more restricted over time because of the rising pit lake level. Periodic site inspections after the first decade of post-closure will likely rely more on drone flight surveys or other remote scanning technology to assess pit wall conditions in areas that are no longer accessible to site staff. The instrumentation and monitoring system during the post-closure period will take advantage of anticipated future technology improvements to facilitate monitoring remotely.

Currently, the post-closure monitoring related to the Open Pit is expected to be as follows:

- Routine Site Inspections
  - Frequency: Quarterly and after rainfall > 3 inches in 24 hours consistent with other compliance site inspections
  - Visual Inspection Components
    - Evidence of crest failures in the upper pit benches,
    - Evidence of substantial pit slope creep or failure,
    - Evidence of substantial cracks or erosion features in the pit walls, and
    - Evidence of blockage in stormwater run-on/runoff control features and berms protecting the closed, reclaimed facilities adjacent to the Open Pit.
- Maintain Piezometer and Groundwater Monitoring Network
  - Compile data from then-existing vibrating wire piezometers and monitoring wells in the pit area to assess rate of the recovering groundwater level and the re-pressurization of the pit walls after dewatering ceases. Note: the monitoring network is a required component of the APP to demonstrate the extent of the post-closure passive containment capture zone around the pit.
- Maintain a Slope Stability Prism Network
  - Quarterly review of the measurements from a representative prism network to assess slope movement and rate of movement in sectors where historical slippage occurred
- Drone Survey or Other Remotely Scanned Survey of Pit Wall
  - Annual aerial or other remotely sensed survey of pit walls to document the general conditions and presence of substantial pit slope creep or failure that has the potential to endanger public safety, to risk the integrity of the reclaimed mine facilities and fencing, or to cause damage to local infrastructure such as pit fencing, berms, or access roads.
- Specific pit walls sectors are expected to reach a relatively unchanging condition after a number of years such that the monitoring would decrease to annual or biennial monitoring. PVMC will perform an annual review of the pit wall status and relevancy of the monitoring program components to ensure that on-going monitoring is relevant to the conditions and trends noted relative to the prior years and that changes in monitoring and/or mitigations are made as need to adjust to site conditions during the post-closure period.

## 5.2 Adaptive Management and Mitigation Measures

The PVMC Mine Department monitors pit excavation progress, pit walls, and ramp road access on a 24-hour basis with a range of controls as described in Section 2.3. PVMC's adaptive management approach and commitment to implement preemptive measures to ensure protection for the health



and safety of on-site workers and for the environment is a routine part of daily operations. The Mine Department personnel are trained to mitigate and respond to unplanned pit wall creep or failures that may develop. Site staff are alert and empowered to note and report any unplanned event to PVMC management personnel that may have the potential to impact health/safety and environmental protections on site or endanger public safety.

### 5.2.1 Adaptive Management

The focus of the inspections varies depending on the current operational areas and challenges at PVM. A program of the adaptive management in place consists of the following elements:

- Review action items from the previous pit wall scans, instrumentation data, and routine inspections;
- Visit problematic areas reported by Mine Department, PVMC management, or other site personnel to assess site conditions and mitigation steps, as needed per the established TARP or other current site geotechnical guidance;
- Evaluate existing monitoring frequency and appropriate monitoring activities for problematic areas. Increase inspection frequency (daily, weekly, monthly) or modify monitoring activity as needed to ensure sufficient data collection and monitoring is taking place of a potentially new or existing slope failure.
- Review annually the geotechnical slope monitoring guidelines and TARP (or other established trigger levels) to ensure relevancy of the radar alarm settings for responding to the presence of slope deformation and the velocity of slope movement. Update TARP annually as needed and circulate to members of the geotechnical slope monitoring team.

### 5.2.2 Mitigation Measures during Operations

Mitigation measures that have been implemented in the past and that are currently used by PVMC, as relevant, to address slope creep and failures within the Open Pit, including areas that have potential for unplanned encroachment on NFS land include:

- Establish and maintain berms and stormwater controls around the pit perimeter to minimize gullyng and potential erosion owing to stormwater run-on/run-off. Relocate berms, ditches, and channels as the pit and other mining facilities expand;
- Remove (excavate) material from identified unstable benches to de-weight and stabilize the pit wall slopes;
- Establish and enforce setback distances for mine facilities placed adjacent to the pit rim (see Table 1 for setback distances);
- Place temporary or permanent buttress to shore up the toe of any unstable bench slopes that have the potential to impact a pit ramp road / perimeter road, an active working area in or around the pit, surface infrastructure at the pit rim, or to cause unplanned disturbance on NFS land; and
- Placement of horizontal or vertical depressurizing wells where effective.

### 5.2.3 Mitigation Measures during Post-Closure Period

The post-closure stability analysis described in Section 3.2.2 will evaluate the probability of occurrence and spatial extent of long-term slope failures in areas that may potentially result in a loss

of NFS lands from the TNF post-mine land use inventory. Mitigation measures proposed by PVMC to address threats to public health and safety slope and failures in areas subject to long-term creep when robust monitoring is no longer active include:

- Construct and maintain final ditches, berms, and stormwater controls for the LOM pit and dump configuration to minimize rilling and erosion on adjacent NFS land. This includes constructing berms to direct non-contact stormwater around the remnants of South Wall Slide and around other unstable areas adjoining NFS land, if present and as visible in the LOM pit. This also includes constructing a diversion channel (Figure 1) or channel segments, as needed, on private PVMC property along the eastern flank of the Castle Dome Marginal Dump to minimize channeling that could occur beneath the dump and ponding upstream of the dump on the adjacent NFS land. To ensure effective operation and minimize post-closure maintenance, the design of the constructed channels will consider the relevant upstream watershed basin and be sized to accommodate flows from a 100-year/24-hour storm event or a higher peak discharge from the 100-year storm;
- At closure, verify that the required minimum 250-ft setback is in effect from the toe of Castle Dome Marginal Dump to the edge of the Open Pit and remove dump materials, if present, that are within the setback zone;
- At closure, evaluate the need to remove (excavate) select materials from identified unstable benches to de-weight and stabilize the pit wall slopes immediately adjacent to NFS land;
- Place a permanent buttress to shore up the toe of unstable bench slopes that have the potential to impact an essential perimeter access road or to cause unplanned disturbance on immediately adjacent NFS land; and
- Provision the costs associated with post-closure site inspections and maintenance described in Section 5.1.2 through a bond instrument authorized under 36 Code of Federal Regulations part 228.13. The reclamation cost estimate and bond to be filed with TNF assumes closure costs and a 30-year post-closure period consistent with the post-closure bonding associated with the APP filed with ADEQ, as described in the *Closure and Post-Closure Strategy* (SRK 2016). The duration and types of post-closure activities may be modified following discussion with and approval by TNF in response to technology advancements, and slope stability trends and monitoring results noted during the post-closure period. Note that the bond filed with the Arizona State Mine Inspector for the Mined Land Reclamation Plan costed a 10-year post-closure monitoring and maintenance program assuming that the revegetation of disturbed areas would be at a mature stage within 10 years following soil cover placement and seeding.

# 6 Reporting and Documentation

Table 7 lists the schedule and components of supplemental reports and documentation to be submitted to TNF related to pit wall stability and mitigations. The reports include a post-closure stability predictive evaluation (Section 6.1) and routine annual reports (Section 6.2).

## 6.1 Post-Closure Stability Model Report

PVMC will prepare a stability evaluation of the expected post-closure conditions of the pit assuming the presence of a steady state pit lake (SRK, 2019) (see general discussion in Sections 3.1.3 Post-Closure Period and 3.2.2). The 2D limit equilibrium model will incorporate available field and laboratory data and estimate the probability that a pit wall would have a deep-seated failure that would potentially endanger public health and safety, and/or encroach on NFS land. The model will incorporate assumptions related to long-term weathering and degradation of rock strength.

The report will address the possible failure conditions for the pit slopes and summarize for the reader's understanding the general conditions that work against stability (i.e., unfavorable fault orientations parallel to the pit walls, major zones of structural weakness, low-strength materials, groundwater inflows resaturating the dewatered pit slopes, stormwater rilling of the benches, etc.) and what natural conditions work in favor of achieving relative long-term stability (competent bedrock, dry climate, relatively low-reoccurrence seismic frequency zone). The report will summarize what conditions in the pit are different from the surrounding natural landscape and how the benched landforms may change during the post-closure periods to mimic natural landscapes as a result of gradual rilling, erosion, and slope sloughing. The report will have recommendations, if any, for adaptive management and mitigation. The report will be submitted by November 30, 2020 to TNF per schedule listed in Table 7.

## 6.2 Annual Stability Reports

PVM will prepare an annual status report summarizing the:

- Current pit progress showing the (1) end of year topography and (2) an outline of unstable areas identified during the previous year;
- Stability conditions noted during the previous year in the active and inactive pit walls adjoining NFS land (i.e., south and east pit sectors). The discussion will briefly describe the (1) type of feature identified in the unstable area (i.e., creep, small slumps, or larger-scale pit-wall slope failure) with photo documentation, (2) approximate rate and general vector of movement, and (3) trend of the rate of movement (i.e., increasing, stable, decreasing) relative to the previous year;
- Approximate acreage of new disturbance related to creep, slumps, or slope failures that encroached on NFS land during the previous year;
- Approximate acreage of total disturbance (historical and current during the previous year) attributed to specific unstable areas that have encroached on NFS land;
- Mitigation measures taken during the previous year to address actual or expected failure, creep, or sloughing that may the potential to cause unplanned disturbance on NFS land.

The annual report will include a section on Adaptive Management and Mitigation Measures. This section will describe:

- Completed or planned substantive changes to the pit wall stability monitoring and alert management program; and
- Planned activities to stabilize specific areas, if relevant, adjoining NFS land;
- Substantive changes required in LOM design, if relevant, as a result of pit wall instabilities or failures in the previous year.

PVMC will seek authorization from TNF to modify the approved Mine Plan of Operations should a substantive change in LOM design be required. The annual pit wall stability and mitigation measures report will be provided to TNF by May 30 per schedule in Table 7.

# 7 References

- Arizona Department of Environmental Quality, 2004, Arizona Mining Guidance Manual BADCT: ADEQ Publication # TB 04-01, 298 p., accessible at [https://legacy.azdeq.gov/function/laws/download/TB\\_04-01\\_Arizona\\_Mining\\_BADCT\\_Guidance\\_Manual.pdf](https://legacy.azdeq.gov/function/laws/download/TB_04-01_Arizona_Mining_BADCT_Guidance_Manual.pdf).
- Call, R.D., Cicchini, P.F., Ryan, T.M., Pryor, P.R., 2000, Managing and analyzing overall pit slopes in Hustrulid, W. Kuchta, M. eds., Open pit mine planning & design, Volume 1 – Fundamentals: SME, Littleton, Colo.
- Capstone Mining Corp., 2016, Pinto Valley Mine life extension – Phase 3 (PV3) pre-feasibility study, NI 43-101 technical report, Pinto Valley Mine, Miami, Arizona: published report accessible on [www.sedar.com](http://www.sedar.com), February 23, 2016, 193 p.
- De Bruyn, I., Prado, D., Mylvaganam, J., Walker, D., 2019, Geotechnical considerations of the stability of open pit excavations at mine closure – Some scenarios *in* Fourie, A.B. and Tibbett, M., eds., Mine Closure 2019: Australian Centre for Geomechanics, Perth Australia, p. 235-248.
- Hoek, E. and Brown, T.T., 1997, Practical estimates of rock mass strength: International Journal of Rock Mechanics and Mining Sciences, 34(8), p. 1165-1186, [https://doi.org/10.1016/S1365-1609\(97\)80069-X](https://doi.org/10.1016/S1365-1609(97)80069-X).
- Priest, S.D. and Brown, E.T., 1983, Probabilistic stability analysis of variable rock slopes: Transactions of Institute of Mining and Metallurgy, Section A Mining Industry, v. 92, p. A1-12.
- Read, J and Stacey, P., eds., 2009, Guidelines for open pit slope design: CSIRO Publishing, Collingwood, Australia.
- SRK Consulting (SRK), 2015, Geomechanical data report – Pinto Valley Mine: unpublished report prepared for Capstone Mining Corp., April 3, 2015, 72 p., 4 appendices.
- SRK Consulting, 2018a, Hydrogeology summary – Pinto Valley Mine: unpublished report prepared for Pinto Valley Mining Corp., January 8, 2018, 77 p., 3 appendices.
- SRK Consulting, 2018b, Response to PVM – NEPA EIS Data Request Record #12: unpublished memorandum prepared for Pinto Valley Mining Corp., May 21, 2018, 17 p. (submitted to TNF)
- SRK Consulting, 2019, Pinto Valley Mine – Groundwater modeling for mine extension: unpublished report prepared for Pinto Valley Mining Corp., May 3, 2019, 181 p., 2 appendices. (submitted to TNF)
- Steffan, O.K.H, Contreras, L.F., Terbrugge, P.J., and Venter, J., 2008, A risk evaluation approach for pit slope design, *in* Proceedings of the 42nd US Rock Mechanics Symposium: American Rock Mechanics Symposium, June 29-July 2, 2008, San Francisco.
- Van Zyl, D., 2009, Open pit closure, *in* Read, J. and Stacey, P., eds., Guidelines for open pit slope design: CSIRO Publishing, Collingwood, Australia.
- WestLand Resources, 2016, Plan of Operations – Pinto Valley Mine: plan prepared for PVMC and submitted to Tonto National Forest, May 13, 2016, 78 p., 9 appendices.

## Tables

**Table 1 Recommended setbacks from top crest of Open Pit to toe of mine facilities**

Facility	Description	Minimum Setback Distance from Crest of Open Pit (ft)
Low-grade Ore Leach Pile (Leach Pile)	Existing facility of low-grade leach ore located north of the Open Pit. Leached rock material is present in the northwestern and northern pit slope walls; leached materials will be present in the northwestern and northern pit slope walls for remaining LOM.	No recommended setback (zero-ft offset)
Main Dump	Existing facility of waste rock dominantly placed on the surface of the existing Leach Pile with some overlap onto natural ground on private PVMC property on the eastern and northern sides of the Leach Pile.	No recommended setback
Castle Dome Marginal Dump	Existing facility of waste rock and marginally mineralized material placed on the upper benches of the south-central area of the Open Pit. The waste rock materials may be reprocessed at the end of the PVM mine life or remain in place at end of mine life and during the post-closure period.	250 feet
Inert Limestone Stockpile	Existing stockpile for limestone reclamation materials located east of the Leach Pile and the northeast of the Open Pit.	150 feet
North Barn Marginal Dump	Planned facility for waste rock and marginally mineralized material that will be deposited within an existing depression (North Barn area) west of the rim of the Open Pit on private PVMC property.	No recommended setback
West Dump	Planned facility for waste rock to be constructed at the base of the existing Leach Pile in Gold Gulch on private PVMC property. Will be adjacent to the northwestern Open Pit area.	No recommended setback

Source: SRK Consulting

**Table 2 Recommended maximum inter-ramp and overall slope angles for LOM pit**

Rock Type	Maximum Inter-ramp Angle (IRA) / Overall Slope Angle (OSA)	Notes and Comments
	Single Bench (45-50 ft heights except where noted)	
West Wall / Tailings & Waste Rock	32 IRA / 27 OSA	Use for Castle Dome tailings, TSF1/2, west waste rock dumps
Basalt	35	West Wall
Gila Conglomerate	35	West Wall
Whitetail Conglomerate	35	West Wall
	48	East Wall: Use Ruin Granite 48
Diabase	42	West Wall
	48 / 42	East Wall: Use Ruin Granite 48
Limestone Formations	40	Walls other than East Wall
	48 / 42	East Wall: Use Ruin Granite 48
Pinal Schist Shear Pinal Schist South Wall	27 / 24	Limit equilibrium slope angle. FS~1.0. Expect deformation at an angle of 23° from toe of slope. Use 18 ° for boundary offset.
	27	
Ruin Granite	48 (90-ft double benches) / 42	Use for all sectors / wall orientations at pre-feasibility level. Includes 160 DDR sector. Double bench required to achieve reliability.
Granodiorite	46 / 40	May use Ruin Granite 48 for slope heights less than 200 ft
Granite Porphyry	34	
Units between the main trace of Gold Gulch and West End faults south of Mine Coordinate 6000 N		
Diabase	32 / 30	Overall wall stability governs angle
Pinal Schist	27 / 27	Limit equilibrium slope angle. FS~1.0. Expect deformation at an angle of 23° from toe of slope. Use 18 ° for boundary offset
Granodiorite	28	Overall wall stability governs angle



**Table 2 Recommended maximum inter-ramp and overall slope angles for LOM pit (Continued)**

Rock Type	Maximum Inter-ramp Angle (IRA) / Overall Slope Angle (OSA)
	Single Bench (45-50 ft heights except where noted)
Bummer Fault Zone 0-120, 160-360 Sectors	42
Bummer Fault Zone 120-160 Sector	36
West Wall, Post-mineral Group, West Wall Shear	32 / 30
East Wall, Post-mineral Group	48 / 42
Northwest Pit Bottom Corner	45

Source: Capstone, 2016 p. 123 modified from SRK, 2015

**Table 3 Summary of major faults at PVM**

Fault	Location / Extent / Width	Strike and Dip Direction
South Hill	Post-mineral fault located on the south side of the Open Pit. The fault truncates the ore shell and associated alteration mineralization to the south. Cross cut by Gold Gulch fault zone on the west and the Jewel Hill fault zone on the east.	ENE strike, ~70° north dip
Gold Gulch (Northwest Splay)	Post-mineral fault located in the northwest corner of the Open Pit.	NW strike, ~65° east dip
Gold Gulch (West Branch)	Post-mineral fault that extends from the northwest corner of the Open Pit far to the north of PVM	N to NW strike, dip varies between ~60-75° west
Gold Gulch (East Branch)	Post-mineral fault within granite which partially underlies the Low-Grade Ore Leach Pile.	N strike, ~75° north dip
West End	Post-mineral fault exposed in the west wall of the Open Pit, which extends to the west beneath TSF2 and TSF3.	N-NW strike, ~68° west dip
Jewel Hill	A pair of post-mineral faults on the east side of the Open Pit, which truncate mineralization to the east.	NW strike, ~50° north dip
Bummer	Post-mineral fault that slightly offsets mineralization and affects slope stability in the north wall of the Open Pit.	NE strike, ~63° southeast dip
Dome	Minor post-mineral fault mapped in the Castle Dome mine	NE strike, ~45° south dip

**Table 4 Acceptance criteria for operations period based on risk consequence**

Mine Design Scale	Factor of Safety	Probability of Failure (%)	Reliability Index	Economic Consequences of Failure	Impact
Benching	>1.1	<20%	>3	Low	Berm capacity enough to catch failed material Does not affect ore reserves Operational control Low rehabilitation cost
Interim Walls (Interim and Overall Slope)	>1.2	<10%	>3	Moderate / Serious	Potential effect on the 5-year mining plan Delays the extraction of ore reserves Low rehabilitation cost
Final Walls (Inter-ramp and Overall Slopes)	>1.3	1% to 5%	>3	Serious	Changes to life of mine plan Potential loss of ore reserves High rehabilitation costs Reputation impact
Walls with Critical Infrastructure	>1.5	<1%	>3	Critical	Loss of ore reserves High rehabilitation cost Mine closure Reputation impact

Source: Modified after Priest and Brown (1983), Steffen and others (2008)

**Table 5 Acceptance criteria for post-closure period based on risk consequence as extracted from Table 9.9 in Read and Stacey (2009)**

Slope Scale	Consequence of Failure	FoS (minimum, static)	FoS (minimum, dynamic)
Final Wall	Low	1.2 to 1.3	1.0
	Medium	1.3	1.05
	High	1.3 to 1.5	1.1

Source: Read and Stacey (2009); SRK, 2019b

**Table 6 Results of limit equilibrium stability analysis (Extract from SRK, 2015)**

Analysis Section	FoS (Depressurized)	FoS (Est. Groundwater Surface with Dewatering Measures)	Notes
4	2.25	2.06	
5	1.71	1.61	
6	1.75	1.60	
7 - Upper	1.41	1.0	Minimum on upper slope at FoS 1.0 in Pinal Schist
7 - Lower	1.73	1.54	Minimum on upper slope at FoS 1.0 in Pinal Schist
8	1.38	1.30	Minimum on upper slope at FoS 1.0 in Pinal Schist

Source: Table 8.2.3.1 of SRK, 2015

**Table 7 Schedule and Components for Supplemental Reporting**

What	Notes	Mon. Period	Due
<p>Post-Closure Pit Wall Stability Model Report</p>	<p>Report includes:</p> <ul style="list-style-type: none"> <li>• Summary or maps showing post-closure site conditions (i.e., final pit topography configuration/ pit wall geology, predicted pit lake recovery level)</li> <li>• Summary of field/laboratory data, assumptions for rate of erosion/weathering and rock mass degradation, and the model software used for stability modeling</li> <li>• Location of instrumented wells or piezometers informing estimated groundwater and pit lake recovery assumptions</li> <li>• Illustrations of critical surface profiles used in the analysis</li> <li>• Analysis results and comparison of relevant factors of safety for open pit design (i.e., Reed and Stacy, 2009)</li> <li>• Assessment of probability of a global slide that has a potential to endanger public health and safety and/or encroach on NFS land adjacent to PVM</li> <li>• Conclusions and Recommendations for Adaptive Management and mitigation</li> </ul>	<p>Post-closure modeling period: from end of Year 2039 to 100 years consistent with other PVM predictive models</p>	<p>Nov. 30, 2020</p>
<p>Pit Wall Stability and Mitigation Report</p>	<p>Comprehensive Annual Report includes:</p> <p><u>Stability Review and Summary:</u></p> <ul style="list-style-type: none"> <li>• End of year pit progress topography map</li> <li>• Stability assessment in active and inactive sectors of the Open Pit adjoining NFS land based on PVMC monitoring program</li> <li>• Movement trends (location, velocity) in slope creep areas</li> <li>• Evaluation of change over year</li> <li>• Mitigation steps taken in prior year to mitigate potential encroachment or address actual encroachment onto NFS land</li> </ul> <p><u>Adaptive Management and Mitigation Measures:</u></p> <ul style="list-style-type: none"> <li>• Mitigation steps in the event of rapid, unplanned encroachment beyond planned disturbance footprint</li> <li>• Planned changes in pit wall management and/or to the monitoring changes</li> <li>• Confirm whether or not a substantive change is required to the LOM plan submitted to TNF based on current pit wall condition and/or failures that occurred in the previous year</li> </ul>	<p>Post-closure monitoring period: Calendar year basis (January through December) for 30 years. Monitoring period may be modified per review of stability trends.</p>	<p>May 30 of the following year</p>

## Figures

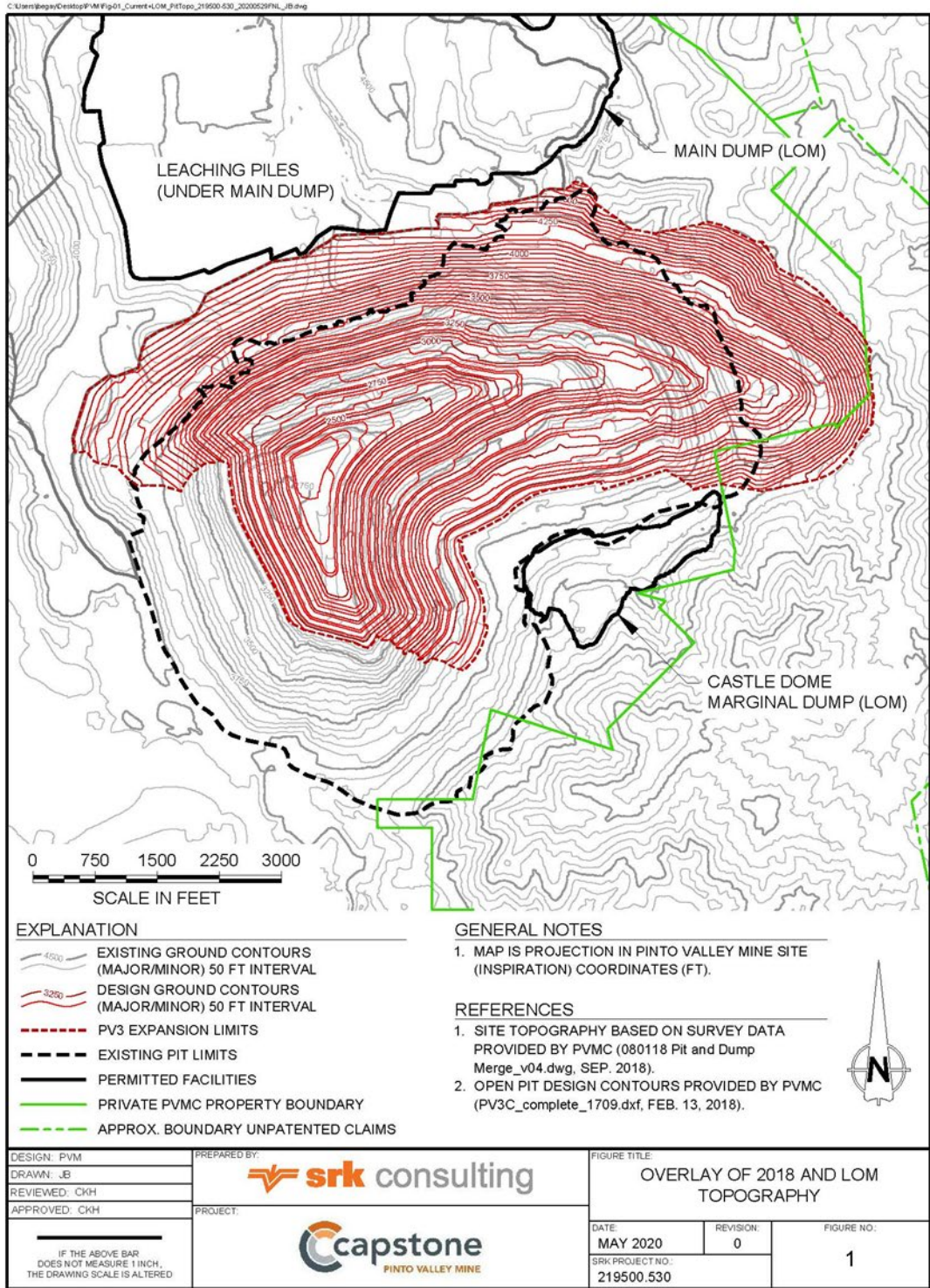
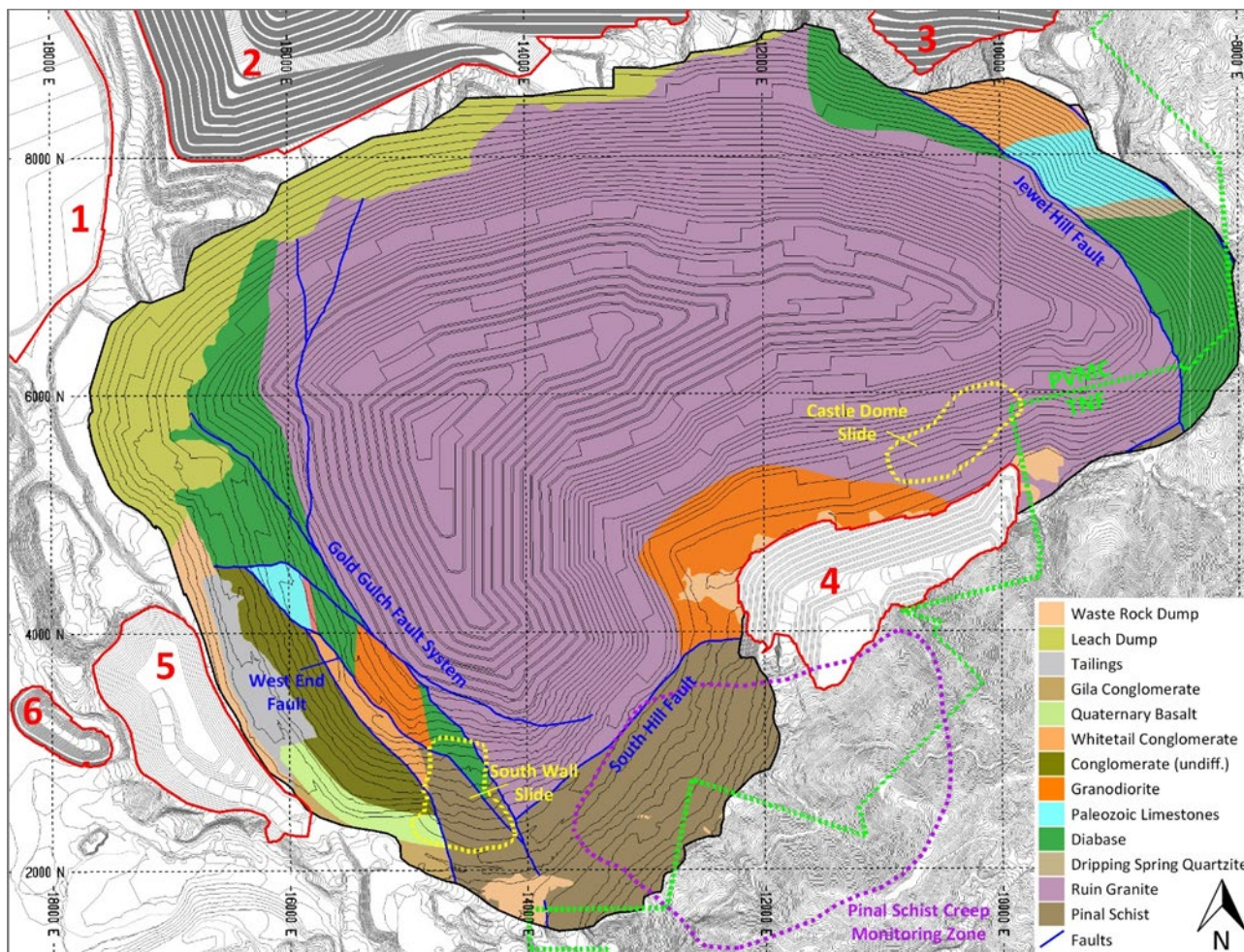

Figure 1 Overlay of 2018 topography (gray) and LOM pit topography (red)



Source: Prepared by SRK based on topography and 2039 mine design provided by PVMC. Grid in Inspiration Mine Coordinates, ft. Sub-surface geology based on pit geology data provided by PVMC, and projected geology based on drilling data and 2039 LOM plan.

Numbered locations as follows: (1) West Dump (planned, LOM), (2) Main Dump (existing, LOM) overlying future decommissioned Low-grade Ore Leach Pile (existing), (3) Inert Limestone Stockpile (existing, LOM), (4) Castle Dome Marginal Dump (existing, LOM), (5) North Barn Marginal Dump (planned, LOM), and (6) Road Crossing Pond (existing).

Slide Areas: Yellow dashed polygon denotes the approximate locations of South Wall Slide (including mined out area of 1985 Pinal Schist Gravity Slide) and the Castle Dome Slide (now mined out).

**Figure 2 Exposed rock and material types in final pit walls under remaining life of mine to 2039**



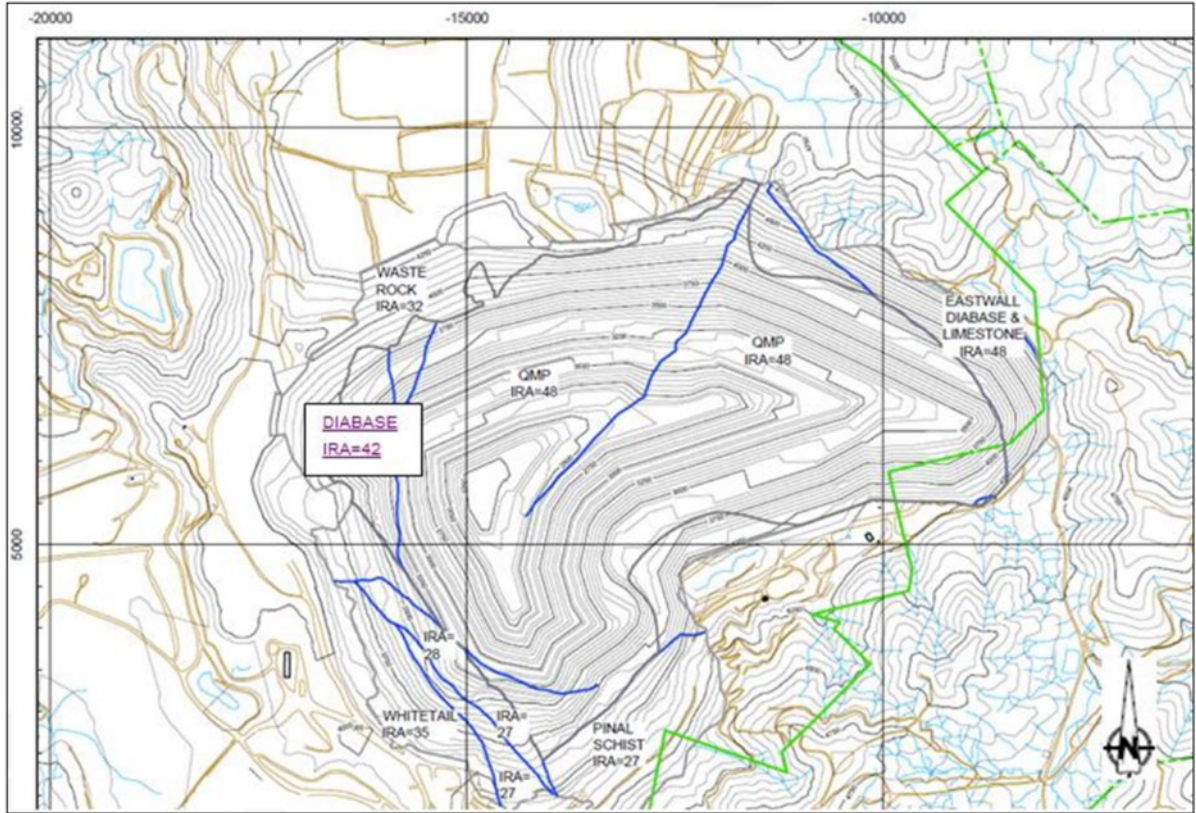

Figure 3 LOM design sectors and inter-ramp angles (IRA)

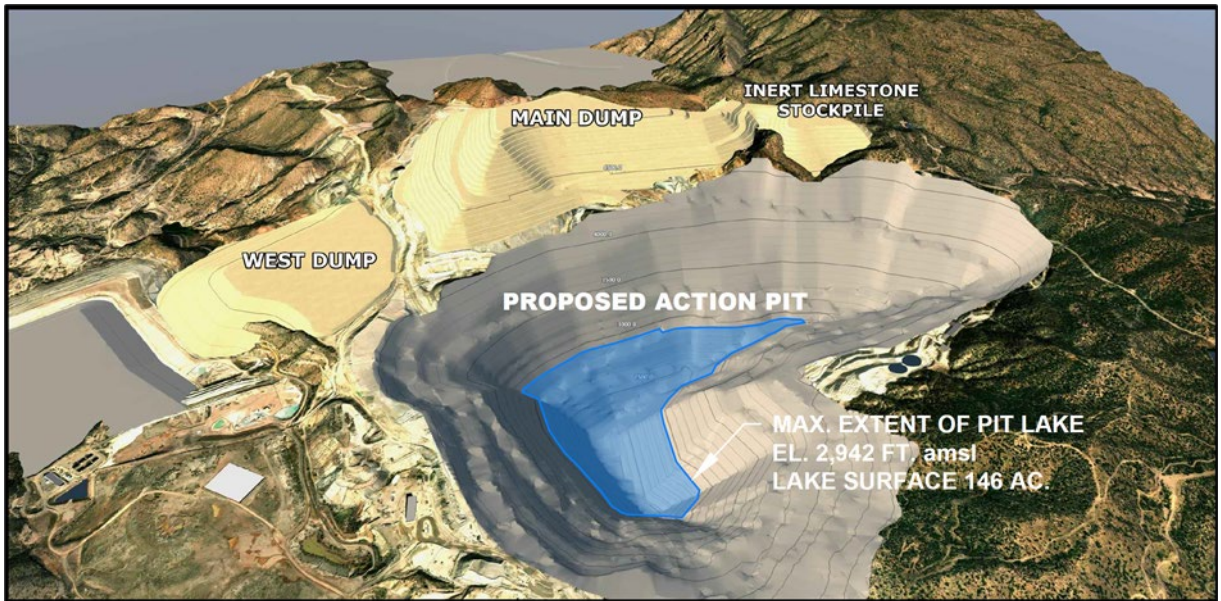
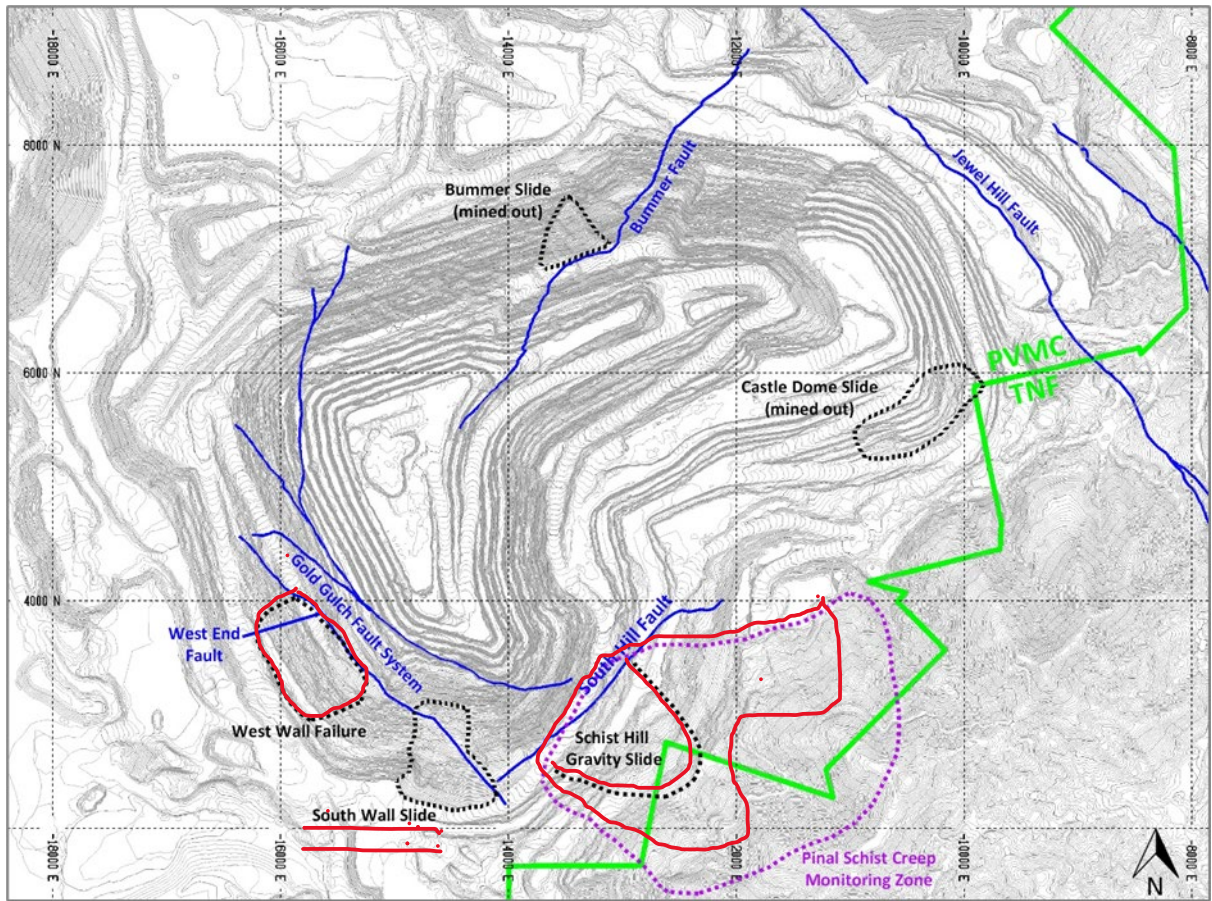

Figure 4 Perspective view of LOM Open Pit and future pit lake



Source: Pit topography provided by PVMC (080118 Pit and Dump Merge\_v04.dwg) Sept. 2018. Approximate locations of slides compiled by SRK including historical mined out and/or subsumed slides (i.e., Schist Hill Gravity Slide, West Wall Failure, Castle Dome Slide), actively creeping South Wall Slide, and the remant Bummer Fault Slide to be mined out during LOM.

**Figure 5** Historical and existing unstable areas overlying current pit topography

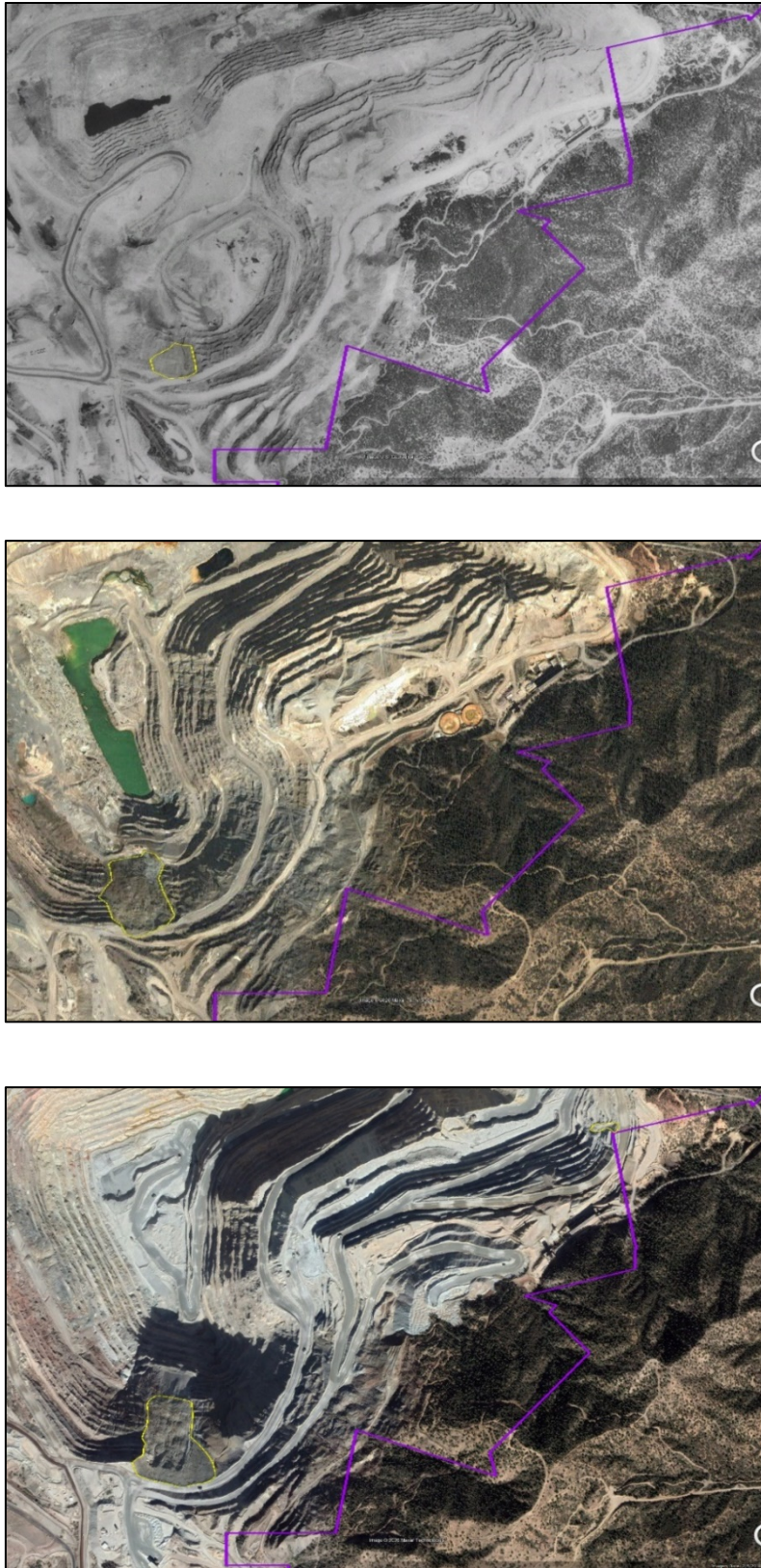
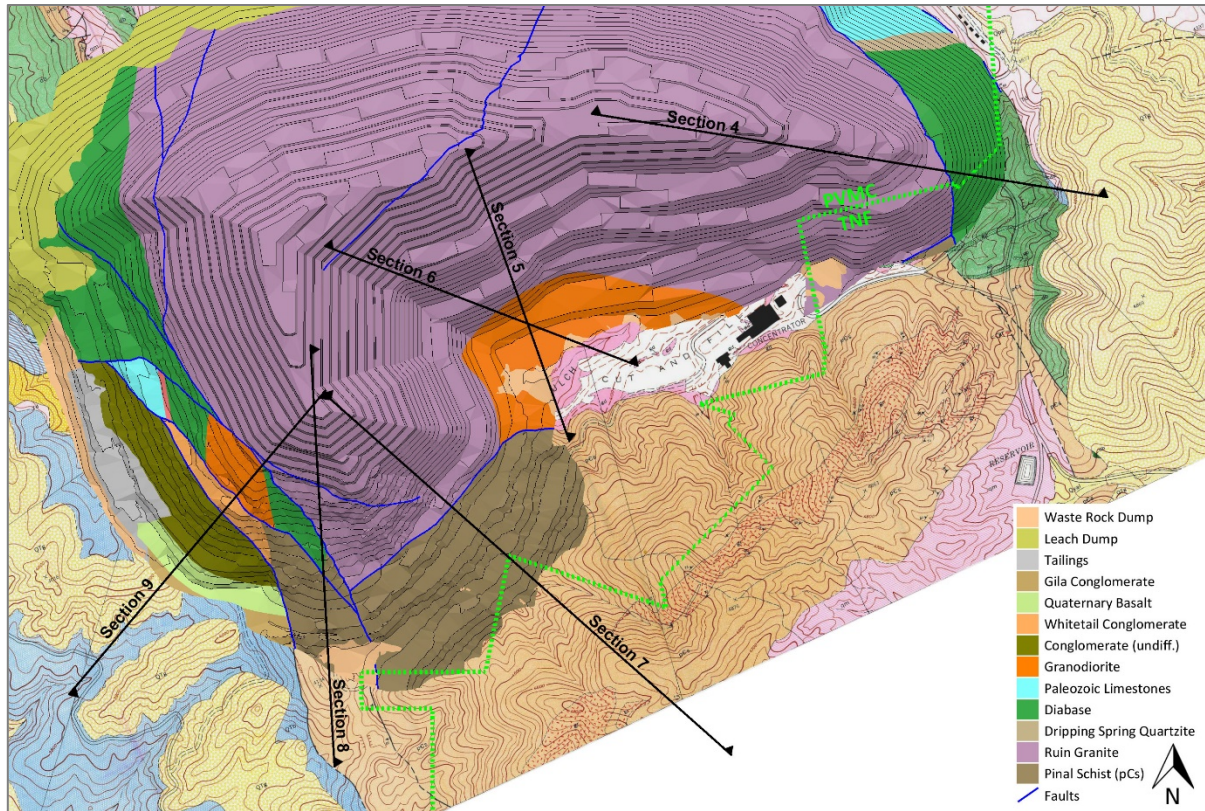
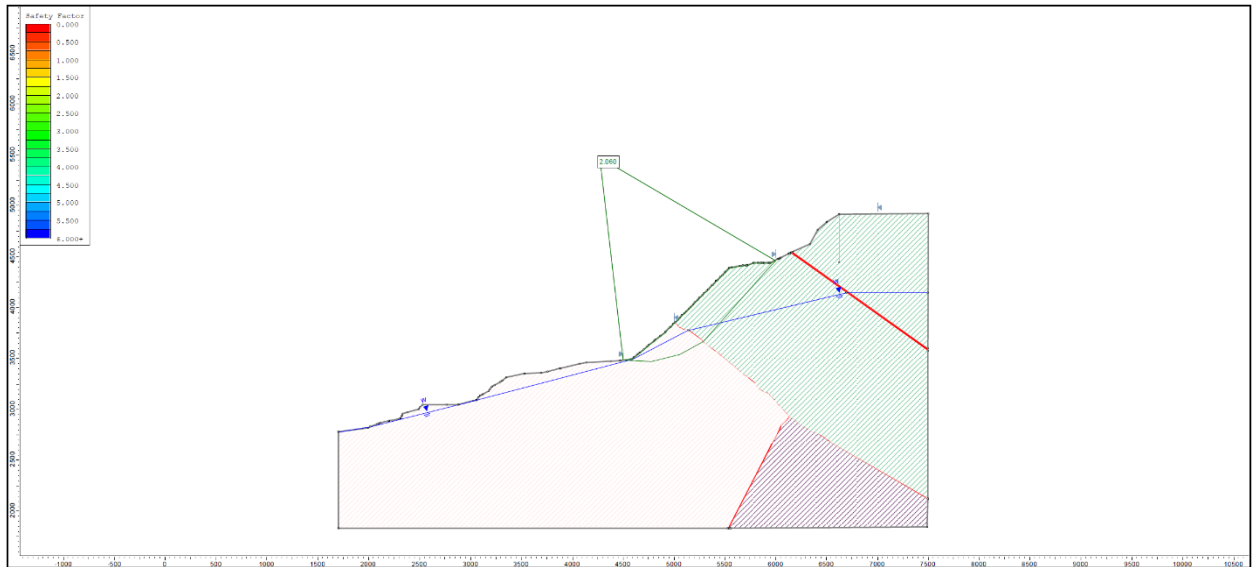

Figure 6 South Wall Slide (yellow) –1992 (top), 2003, 2018 (bottom)



Source: Compiled by SRK using LOM pit wall geology superimposed on the Peterson and others (1951) USGS surface geology map. The formation names and unit colors within the pit rim may deviate from the USGS map conventions. The brown Pinal Schist (pCs) within the southern pit area, for example, is equivalent to the moderate orange-brown unit outside the pit seen on Analysis Section 7.

**Figure 7** Analysis section lines used in 2015 stability analysis for LOM geology and design (SRK, 2015)



Section 4

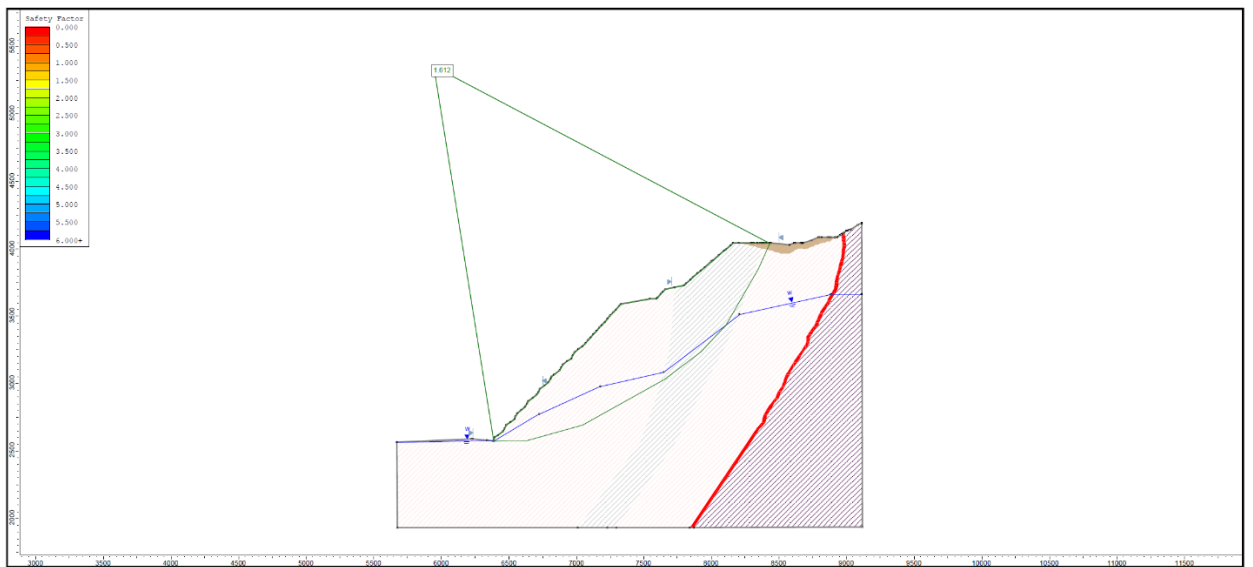

Section 5

Figure 8 Analysis sections 4 (top) and 5 (bottom) adjacent to NFS land (SRK, 2015)

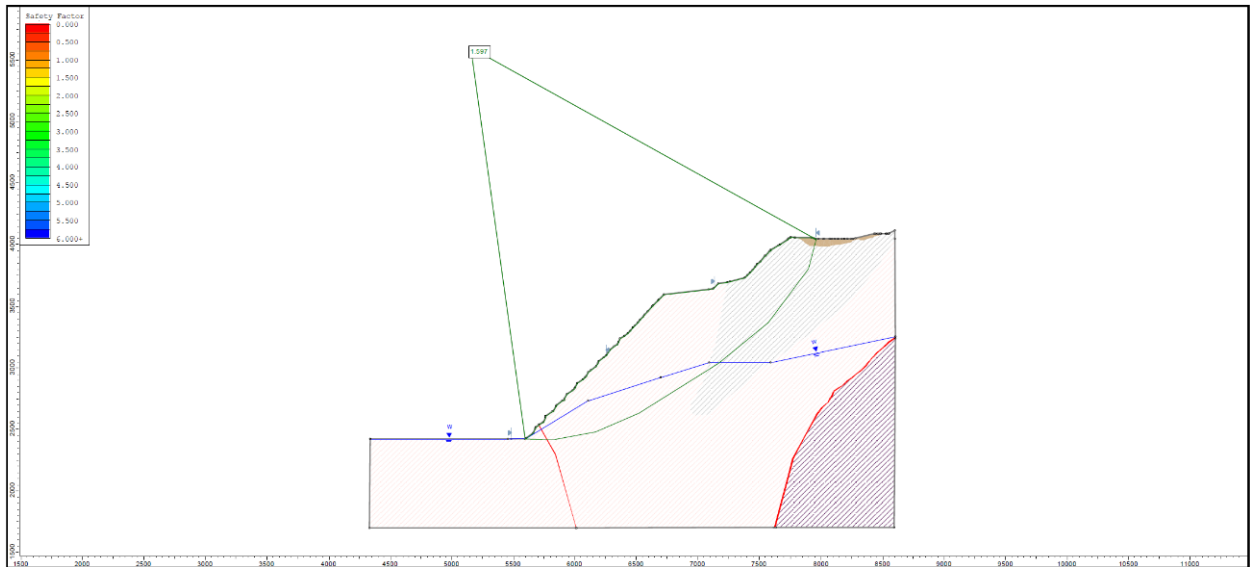

Section 6

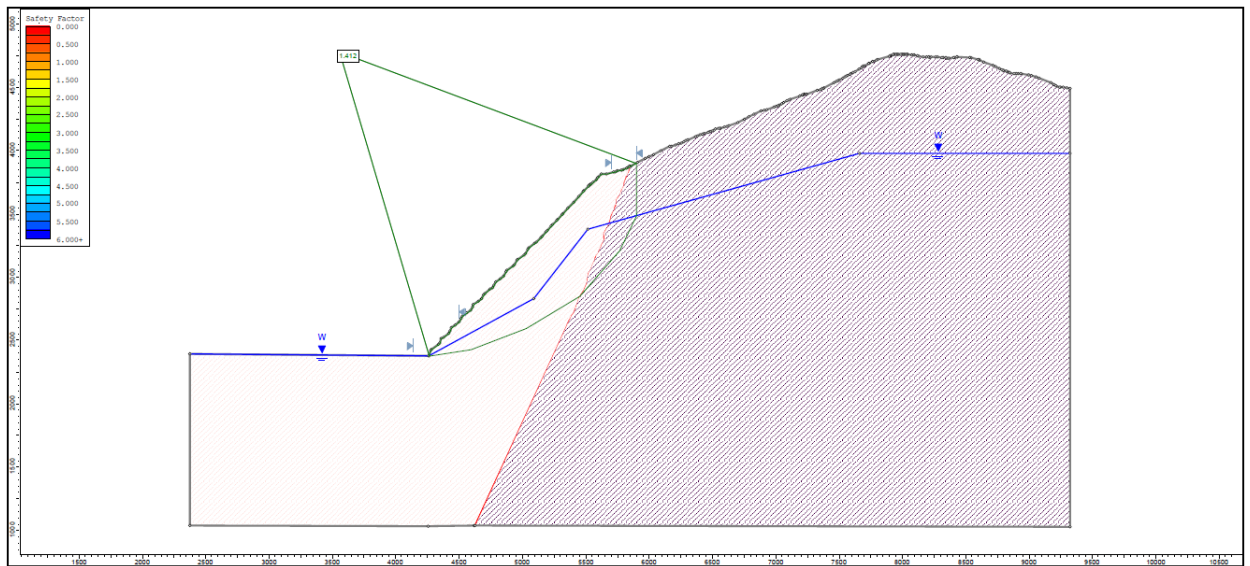

Section 7

**Figure 9** Analysis sections 6 (top) and 7 (bottom) adjacent to NFS land (SRK, 2015)

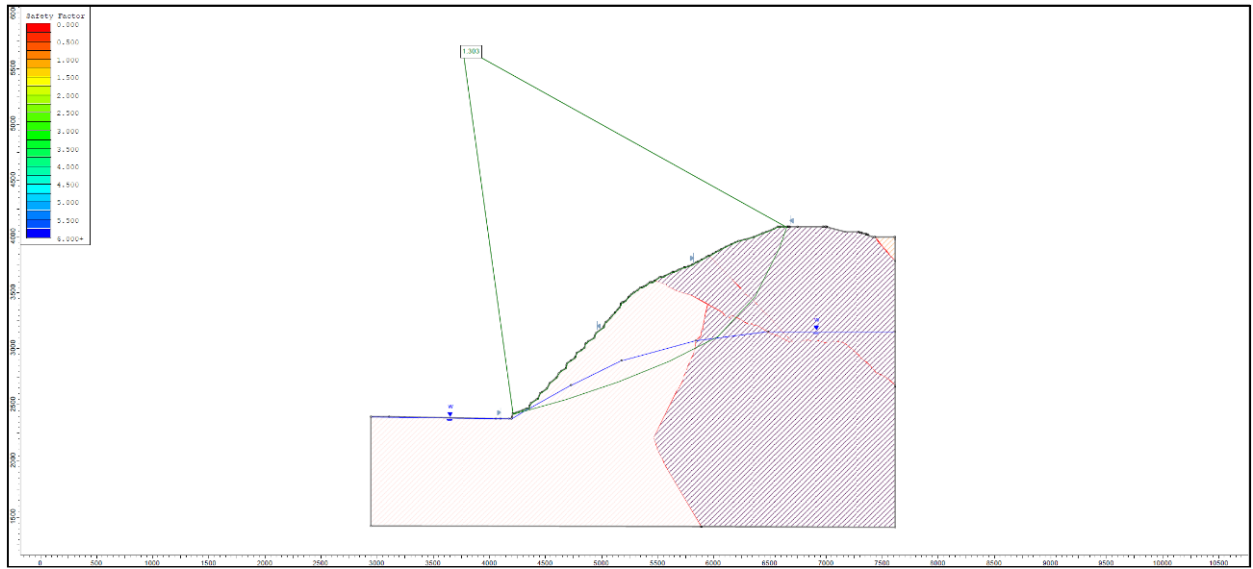

Section 8

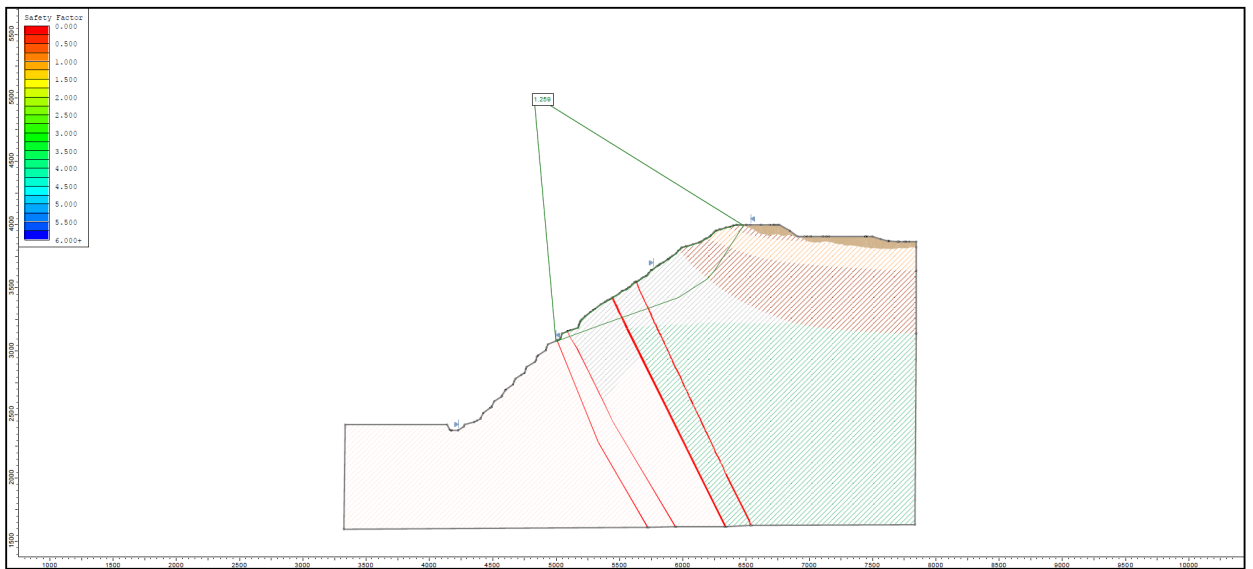

Section 9

Figure 10 Analysis sections 8 (top) and 9 (bottom) adjacent to NFS land (SRK, 2015)

# Appendices



## **Appendix A: Geology and Structure Cross Sections**

SRK Consulting (U.S.), Inc.

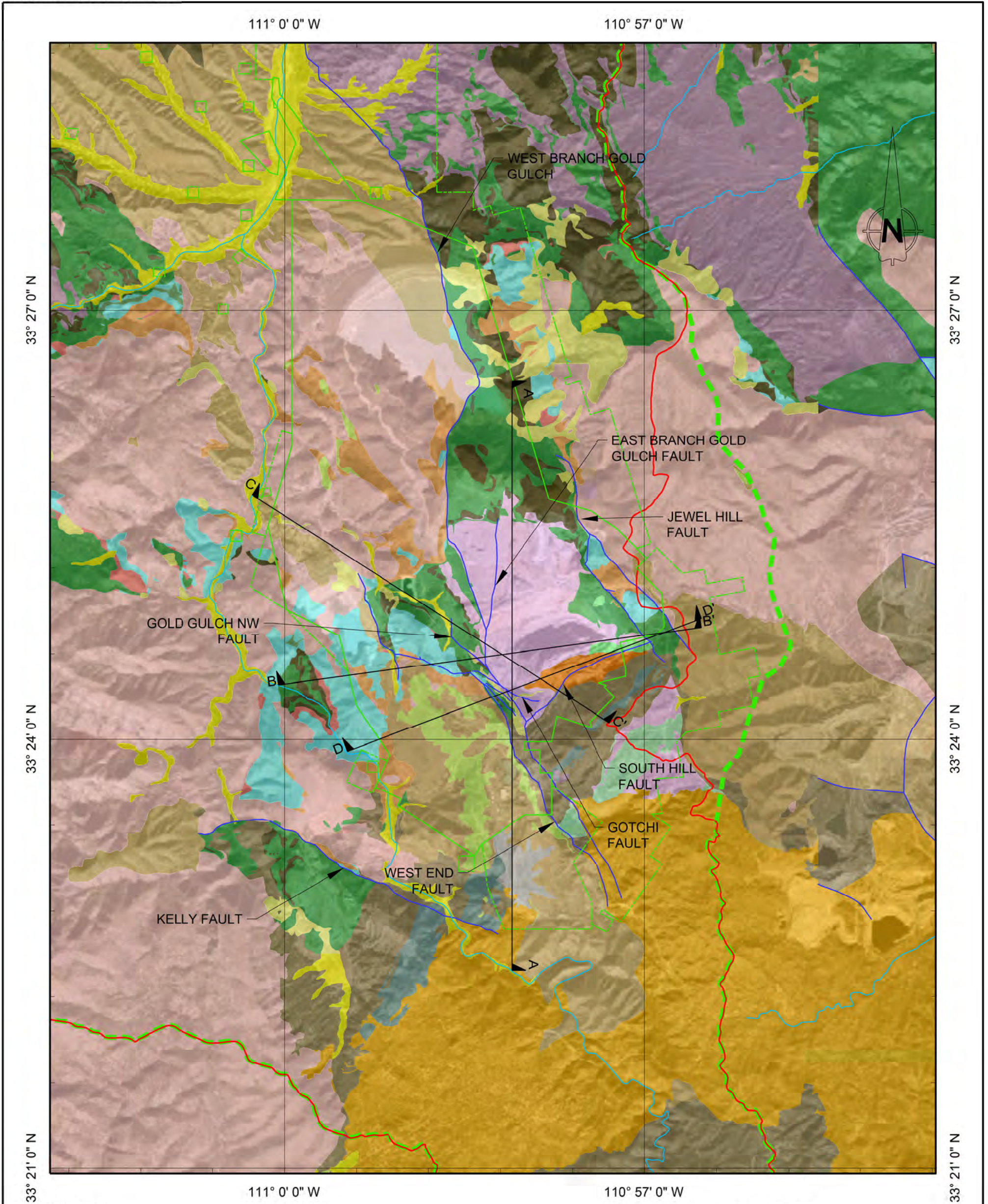

**EXPLANATION**

	PRIVATE PVMC PROPERTY BOUNDARY		DIORITE		APACHE GROUP
	APPROX. BOUNDARY UNPATENTED CLAIMS		SCHULTZE GRANITE		MADERA DIORITE
	PINTO CREEK WATERSHED BOUNDARY		GRANITE PORPHYRY		MANITOU GRANITE
	GROUNDWATER MODEL DOMAIN		GRANODIORITE		RUIN GRANITE
	FAULT		LIMESTONE		PINAL SCHIST
	TAILINGS		TROY QUARTZITE		WHITETAIL CONGLOMERATE
	TALUS/COLLUVIUM		DIABASE		WILLOW SPRING GRANODIORITE
	ALLUVIUM		QUARTZ MONZONITE		
	BASALT				
	GILA GROUP (CONGLOMERATE)				
	DACITE				

**REFERENCES**

1. PRE-MINE GEOLOGY BASED ON PETERSON (1962) AND RICHARD ET AL (2000)
2. MAP PROJECTED IN LOCAL MINE COORDINATE SYSTEM (FT) WITH REFERENCED LATITUDE & LONGITUDE GRID.
3. PRIVATE PROPERTY BOUNDARY PROVIDED BY PVMC (2016).



DESIGN: DR
DRAWN: JB
REVIEWED: KP
APPROVED: CKH

PREPARED BY:

PROJECT:

**PINTO VALLEY MINING CORP.  
NEPA SUPPORT**

FIGURE TITLE: MINE-SCALE PRE-MINE GEOLOGY INSET MAP WITH SECTION LINES A-D		
DATE: MAY 2020	REVISION: A	FIGURE NO.:
SRK PROJECT NO.: 219500.590		A-1

IF THE ABOVE BAR  
DOES NOT MEASURE 1 INCH,  
THE DRAWING SCALE IS ALTERED

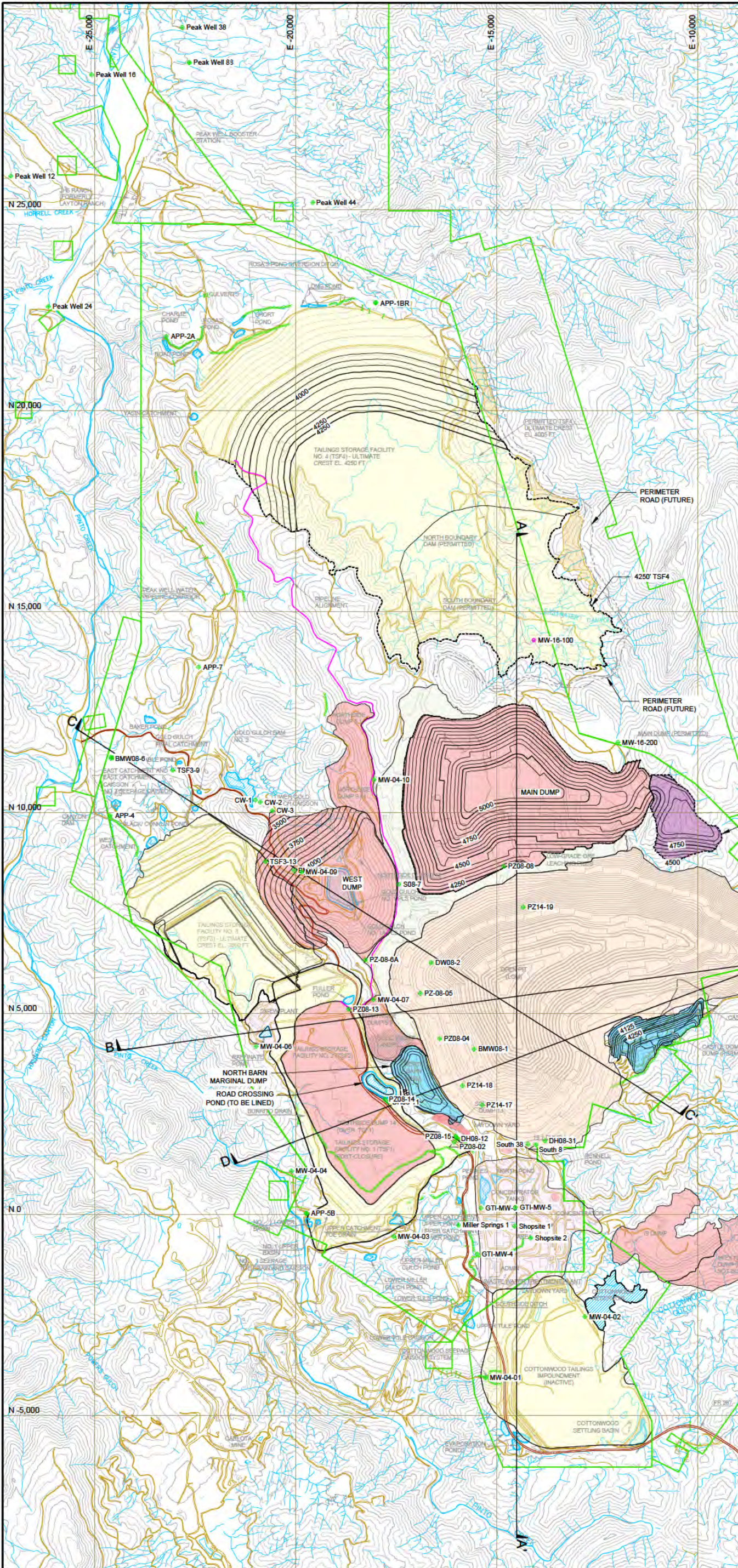

**EXPLANATION**

- EXISTING GROUND CONTOURS (MAJOR/MINOR) 50 FEET INTERVAL
- DESIGN GROUND CONTOURS (MAJOR/MINOR) 50 FEET INTERVAL
- PRIVATE PVMC PROPERTY BOUNDARY
- APPROXIMATE BOUNDARY UNPATENTED CLAIMS
- UNPAVED ROADS
- DRAINAGES
- FOREST ROAD
- PIPELINE ALIGNMENT
- CULVERTS
- PONDS
- UNDER DRAINS
- STORMWATER DIVERSION DITCHES
- FACILITIES AREA
- LEACH PILES
- OPEN PIT (FUTURE)
- WASTE ROCK DUMPS (EXISTING AND FUTURE)
- MARGINAL GRADE DUMPS
- INERT LIMESTONE STOCKPILE (RECLAMATION MATERIALS)
- TAILINGS
- BOUNDARY DAMS
- ROAD CUT MATERIAL AREA
- ACTIVE / INACTIVE PERMITTED FACILITIES
- FUTURE PERIMETER ROAD
- PROPOSED NEW / MODIFIED FACILITIES, MAXIMUM EXTENT SHOWN (AT CLOSURE)
- MINE WELL (ACTIVE/INACTIVE WATER SUPPLY, PERIMETER)
- MONITORING WELL (APP POC)
- SPRING GROUNDWATER POC MONITORING POINT

**GENERAL NOTES**

1. THE SITE MAP IS PROJECTION IN PINTO VALLEY MINE SITE (INSPIRATION) COORDINATES (FT).

**REFERENCES**

1. SITE TOPOGRAPHY (NOV./DEC. 2012) AND LIDAR SURVEY DATA PROVIDED BY TONTO NATIONAL FOREST (Upper\_Pinto\_Mosaic\_20160614.sid, JUNE 14, 2016).
2. PROPOSED ACTION MAIN DUMP, INERT LIMESTONE STOCKPILE, NORTH BARN MARGINAL DUMP, WEST DUMP, AND ROAD CROSSING POND DESIGN CONTOURS PROVIDED BY AJAX (LOM DUMPS.dwg, MAR. 13, 2018). CASTLE DOME MARGINAL DUMP PROVIDED BY INDEPENDENT MINING CONSULTANTS (anns-11Mar14.dwg, MAY 19, 2014). OPEN PIT DESIGN CONTOURS PROVIDED BY PVMC (PV3C\_complete\_1709.dwg, FEB. 13, 2018).
3. WELLS COMPILED BY SRK (JUL. 2018).
4. LAND OWNERSHIP INFORMATION PROVIDED BY PVMC (2016).
5. ULTIMATE LIMIT FOR TSF3 (MAY 2017), TSF4 (AUG. 2016), AND BOUNDARY DAMS (FEB. 2016) PROVIDED BY AMEC FOSTER WHEELER.

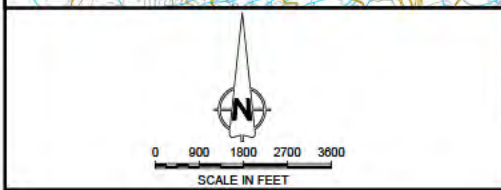

IF THE ABOVE BAR DOES NOT MEASURE 1 INCH, THE DRAWING SCALE IS ALTERED

**srk consulting**

DESIGN: JB	DRAWN: JB	REVIEWED: CKH
CHECKED: CKH	APPROVED: CKH	DATE: MAY 2020

FILE NAME: Fig.A-2\_FVM\_GWDecs\_219500-590\_RevA\_JB.dwg

**PINTO VALLEY MINE CORP.  
NEPA SUPPORT**

SRK JOB NO.: 219500.590

FIGURE TITLE: SITE FACILITIES MAP AND CROSS SECTION LOCATIONS	
ISSUED FOR: REVIEW	
REVISION: A	FIGURE NO. A-2
SRK JOB NO. 219500.590	

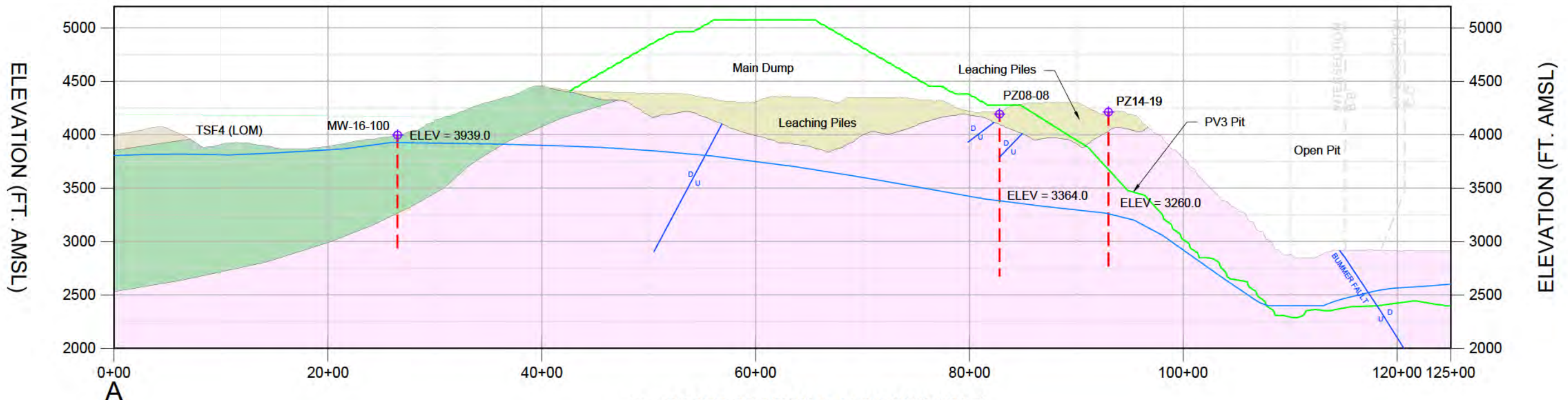

**A CROSS SECTION A-A' (NORTH HALF) LOOKING EAST**

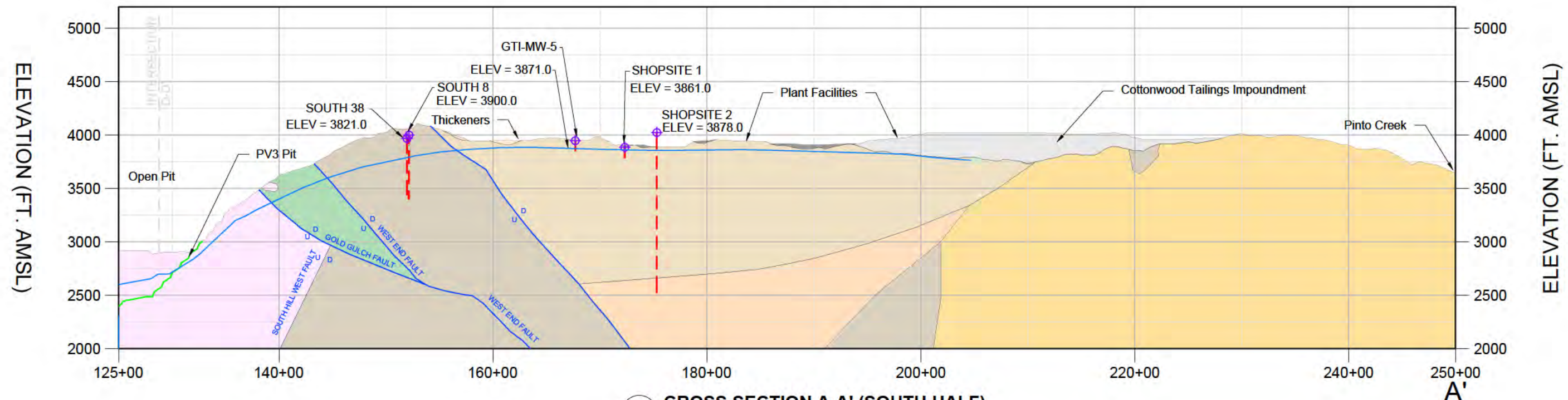

**B CROSS SECTION A-A' (SOUTH HALF) LOOKING EAST**

**EXPLANATION**

PROPOSED ACTION LOM TOPO	WHITETAIL CONGLOMERATE
2018 POTENTIOMETRIC SURFACE	SCHULTZE GRANITE
FAULT	DIABASE
LEACH DUMP	DRIPPING SPRING QUARTZITE
TAILINGS	QUARTZ MONZONITE
WASTE ROCK	PINAL SCHIST
	GILA GROUP (CONGLOMERATE)
	ALLUVIUM

**GENERAL NOTES**

- GEOLOGY PREPARED BY SRK (MAY 2018).
- 2018 POTENTIOMETRIC SURFACE PREPARED BY AJAX AND MODIFIED BY SRK.
- SITE TOPOGRAPHY (NOV./DEC. 2012) AND LIDAR SURVEY DATA PROVIDED BY TONTO NATIONAL FOREST (JUNE 14, 2016).
- PROPOSED ACTION MAIN DUMP, INERT LIMESTONE STOCKPILE, NORTH BARN MARGINAL DUMP, WEST DUMP, AND ROAD CROSSING POND DESIGN CONTOURS PROVIDED BY AJAX (MAR. 13, 2018). CASTLE DOME MARGINAL DUMP PROVIDED BY INDEPENDENT MINING CONSULTANTS (MAY 19, 2014). OPEN PIT DESIGN CONTOURS PROVIDED BY PVMC (FEB. 13, 2018).

DESIGN: DR	PREPARED BY:		FIGURE TITLE:			
DRAWN: CB/JB			GEOLOGIC CROSS SECTION A-A' (LOOKING EAST)			
REVIEWED: CKH			DATE:	REVISION:	FIGURE NO.:	
APPROVED: CKH	PROJECT:	PINTO VALLEY MINING CORP. NEPA SUPPORT		MAY 2020	A	A-3
IF THE ABOVE BAR DOES NOT MEASURE 1 INCH, THE DRAWING SCALE IS ALTERED				SRK PROJECT NO.: 219500.590		

C:\Users\jguy\OneDrive\PM\Fig-A-A-6\_PVM\_GMKSec\_219500-590\_RevA\_B.dwg

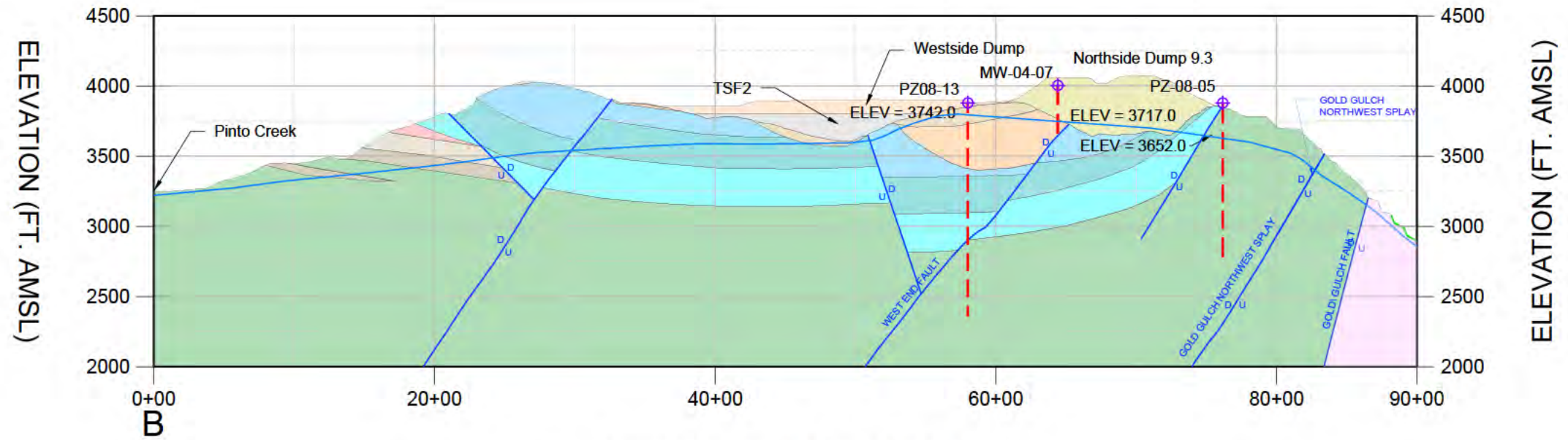

**A** CROSS SECTION B-B' (WEST HALF)  
LOOKING NORTH

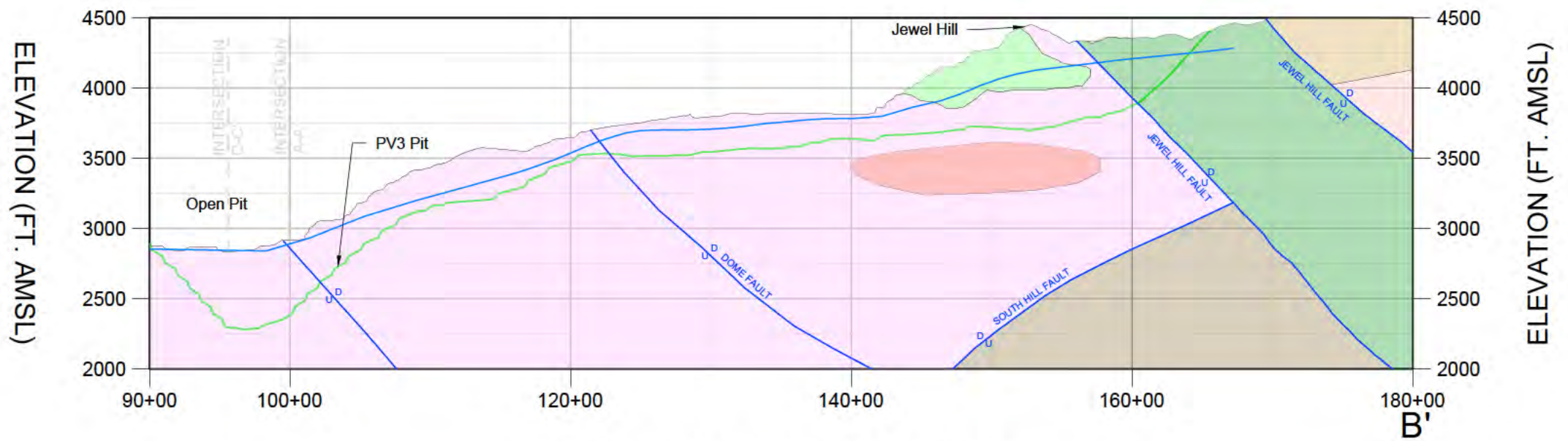

**B** CROSS SECTION B-B' (EAST HALF)  
LOOKING NORTH

**EXPLANATION**

PROPOSED ACTION LOM TOPO	GRANITE PORPHYRY
2018 POTENTIOMETRIC SURFACE	GRANDODIORITE
FAULT	NACO LIMESTONE
LEACH DUMP	ESCABROSA LIMESTONE
TAILINGS	MARTIN FORMATION
WASTE ROCK	TROY QUARZITE
GILA GROUP (CONGLOMERATE)	DIABASE
DACITE	QUARTZ MONZONITE
	PINAL SCHIST
	WHITETAIL CONGLOMERATE

**GENERAL NOTES**

1. GEOLOGY PREPARED BY SRK (MAY 2018).
2. 2018 POTENTIOMETRIC SURFACE PREPARED BY AJAX AND MODIFIED BY SRK.
3. SITE TOPOGRAPHY (NOV./DEC. 2012) AND LIDAR SURVEY DATA PROVIDED BY TONTO NATIONAL FOREST (JUNE 14, 2016).
4. PROPOSED ACTION MAIN DUMP, INERT LIMESTONE STOCKPILE, NORTH BARN MARGINAL DUMP, WEST DUMP, AND ROAD CROSSING POND DESIGN CONTOURS PROVIDED BY AJAX (MAR. 13, 2018). CASTLE DOME MARGINAL DUMP PROVIDED BY INDEPENDENT MINING CONSULTANTS (MAY 19, 2014). OPEN PIT DESIGN CONTOURS PROVIDED BY PVMC (FEB. 13, 2018).

DESIGN: DR	PREPARED BY:
DRAWN: CB/BJB	
REVIEWED: CKH	
APPROVED: CKH	PROJECT:
 IF THE ABOVE BAR DOES NOT MEASURE 1 INCH, THE DRAWING SCALE IS ALTERED	

<b>PINTO VALLEY MINING CORP.</b>	
<b>NEPA SUPPORT</b>	

FIGURE TITLE: GEOLOGIC CROSS SECTION B-B' (LOOKING NORTH)		
DATE: MAY 2020	REVISION: A	FIGURE NO.:
SRK PROJECT NO.:		A-4
219500.590		

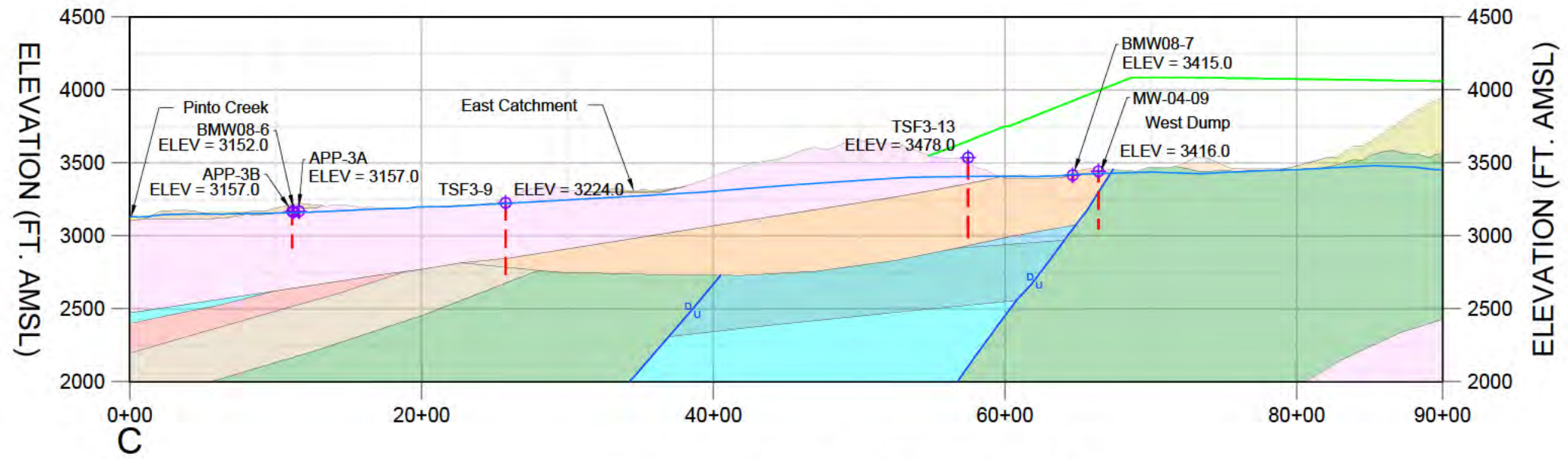

**A** CROSS SECTION C-C' (WEST HALF)  
LOOKING NORTHEAST

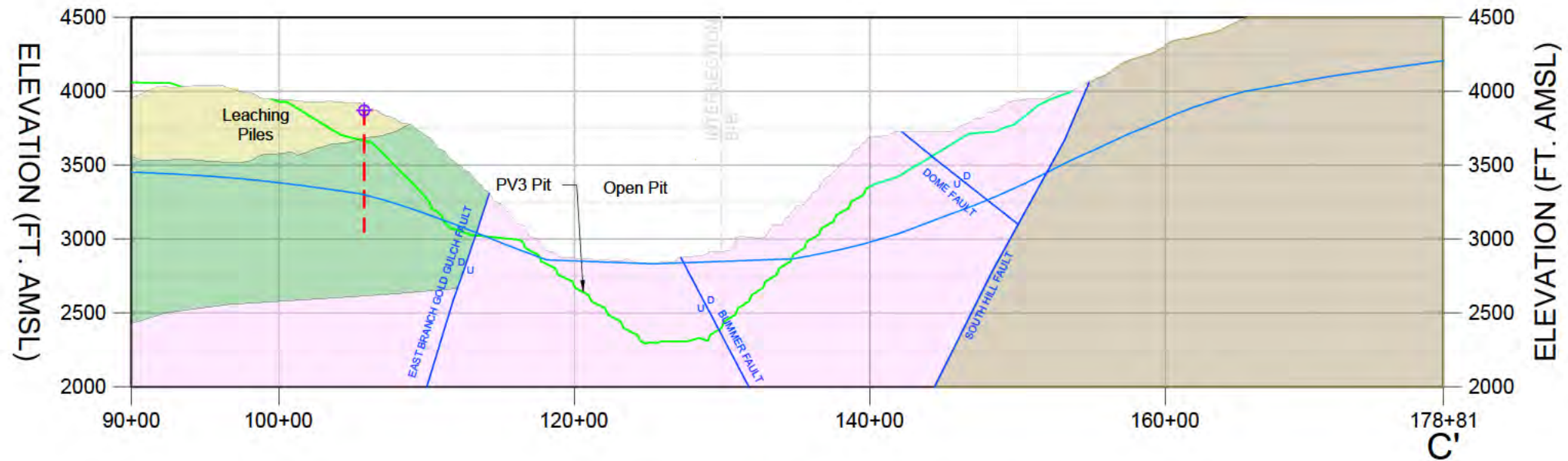

**B** CROSS SECTION C-C' (EAST HALF)  
LOOKING NORTHEAST

**EXPLANATION**

	PROPOSED ACTION LOM TOPO		WHITETAIL CONGLOMERATE
	2018 POTENTIOMETRIC SURFACE		SCHULTZE GRANITE
	FAULT		DIABASE
	LEACH DUMP		DRIPPING SPRING QUARTZITE
	TAILINGS		QUARTZ MONZONITE
	WASTE ROCK		PINAL SCHIST
	ALLUVIUM		GILA GROUP (CONGLOMERATE)
	NACO LIMESTONE		MARTIN FORMATION
	ESCABROSA LIMESTONE		TROY QUARZITE
			DACITE

**GENERAL NOTES**

1. GEOLOGY PREPARED BY SRK (MAY 2018).
2. 2018 POTENTIOMETRIC SURFACE PREPARED BY AJAX AND MODIFIED BY SRK.
3. SITE TOPOGRAPHY (NOV./DEC. 2012) AND LIDAR SURVEY DATA PROVIDED BY TONTO NATIONAL FOREST (JUNE 14, 2016).
4. PROPOSED ACTION MAIN DUMP, INERT LIMESTONE STOCKPILE, NORTH BARN MARGINAL DUMP, WEST DUMP, AND ROAD CROSSING POND DESIGN CONTOURS PROVIDED BY AJAX (MAR. 13, 2018). CASTLE DOME MARGINAL DUMP PROVIDED BY INDEPENDENT MINING CONSULTANTS (MAY 19, 2014). OPEN PIT DESIGN CONTOURS PROVIDED BY PVMC (FEB. 13, 2018).

DESIGN: DR	PREPARED BY:
DRAWN: PM	
REVIEWED: JP/KP	
APPROVED: OH	PROJECT:
IF THE ABOVE BAR DOES NOT MEASURE 1 INCH, THE DRAWING SCALE IS ALTERED	

<b>PINTO VALLEY MINING CORP.</b>	
<b>NEPA SUPPORT</b>	

FIGURE TITLE:		
GEOLOGIC CROSS SECTION C-C' (LOOKING NORTHEAST)		
DATE:	REVISION:	FIGURE NO.:
MAY 2020	A	A-5
SRK PROJECT NO.: 219500.590		

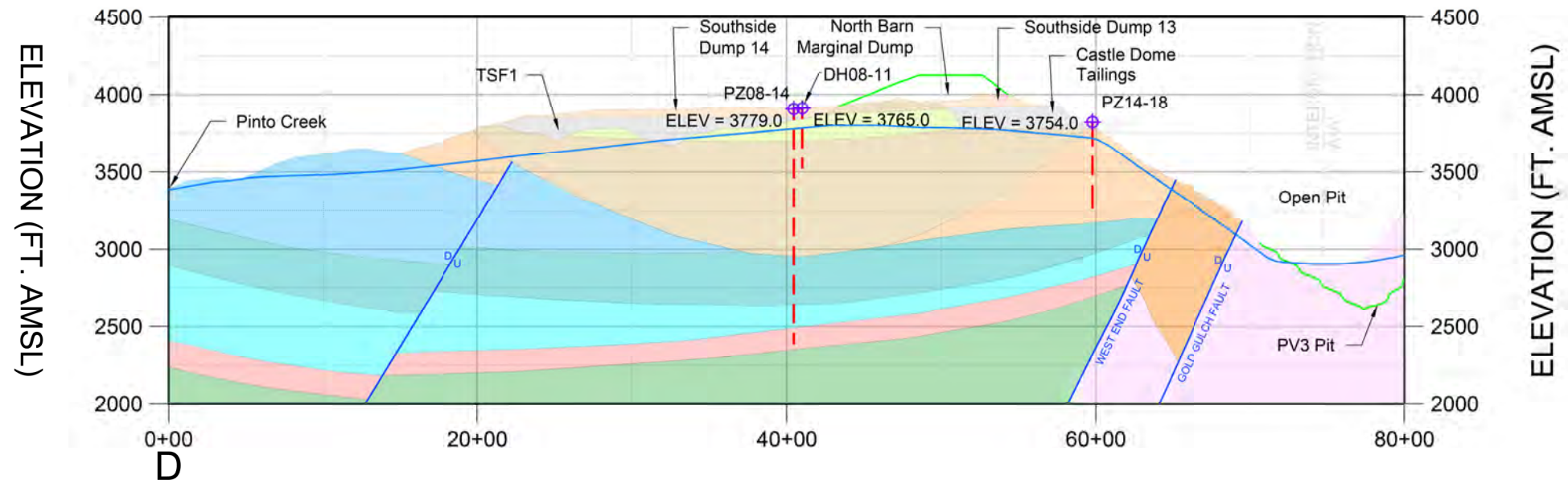

**A** CROSS SECTION D-D' (WEST HALF)  
LOOKING NORTHWEST

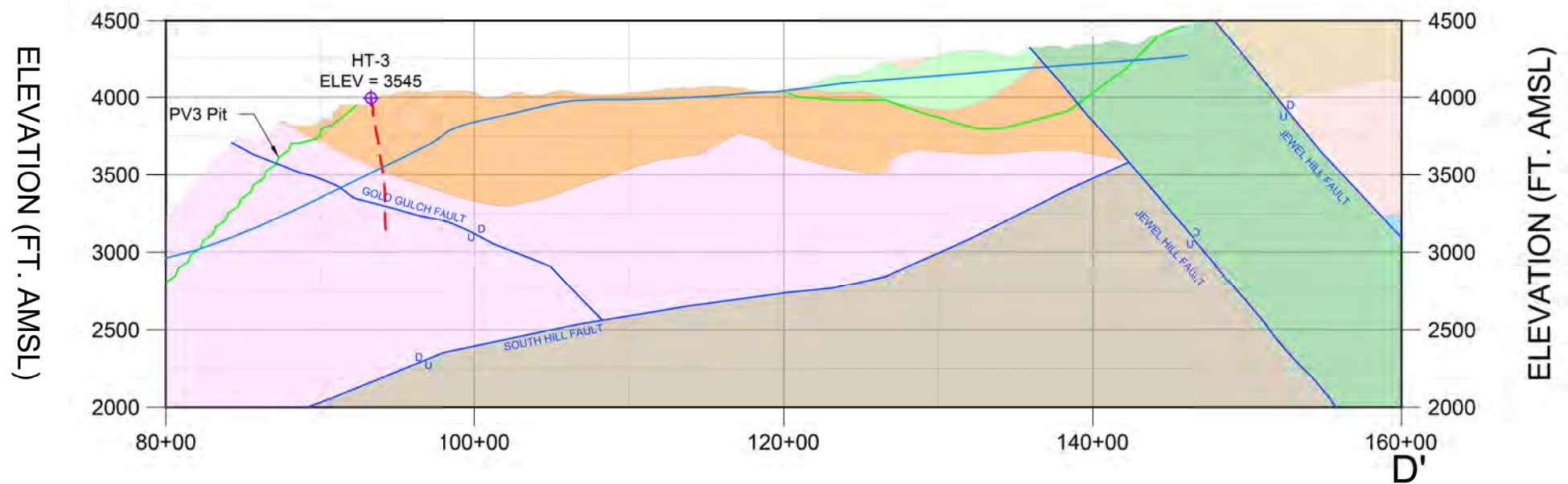

**B** CROSS SECTION D-D' (EAST HALF)  
LOOKING NORTHWEST

**EXPLANATION**

	PROPOSED ACTION LOM TOPO		NACO LIMESTONE
	2018 POTENTIOMETRIC SURFACE		ESCABROSA LIMESTONE
	FAULT		MARTIN FORMATION
	TAILINGS		TROY QUARZITE
	WASTE ROCK		DIABASE
	BASALT		QUARTZ MONZONITE
	GILA GROUP (CONGLOMERATE)		PINAL SCHIST
			DACITE
			GRANODIORITE

**GENERAL NOTES**

1. GEOLOGY PREPARED BY SRK (MAY 2018).
2. 2018 POTENTIOMETRIC SURFACE PREPARED BY AJAX AND MODIFIED BY SRK.
3. SITE TOPOGRAPHY (NOV./DEC. 2012) AND LIDAR SURVEY DATA PROVIDED BY TONTO NATIONAL FOREST (JUNE 14, 2016).
4. PROPOSED ACTION MAIN DUMP, INERT LIMESTONE STOCKPILE, NORTH BARN MARGINAL DUMP, WEST DUMP, AND ROAD CROSSING POND DESIGN CONTOURS PROVIDED BY AJAX (MAR. 13, 2018). CASTLE DOME MARGINAL DUMP PROVIDED BY INDEPENDENT MINING CONSULTANTS (MAY 19, 2014). OPEN PIT DESIGN CONTOURS PROVIDED BY PVMC (FEB. 13, 2018).

DESIGN: DR  
DRAWN: CB/JB  
REVIEWED: CKH  
APPROVED: CKH

PREPARED BY:



PROJECT:

**PINTO VALLEY MINING CORP.  
NEPA SUPPORT**

FIGURE TITLE:

**GEOLOGIC CROSS SECTION D-D'  
(LOOKING NORTHWEST)**

DATE:

MAY 2020

REVISION:

A

FIGURE NO.:

A-6

SRK PROJECT NO.:

219500.590

IF THE ABOVE BAR  
DOES NOT MEASURE 1 INCH,  
THE DRAWING SCALE IS ALTERED

**Appendix B: Slope Monitoring Guidelines and  
Geotechnical Trigger Action Response Plan (March 2020)**

Independent Geomechanics LLC



March 9, 2020

## Capstone - Pinto Valley Mine



## Slope Monitoring Guidelines and Geotechnical TARP



Independent Geomechanics LLC  
2332 Decatur St Apt 4  
Denver, CO 80211  
[wellman@igeomechanics.com](mailto:wellman@igeomechanics.com)  
+1 (520) 232-4467

Table 1. Summary

**Table and Description**

Table 2. Minimum Monitoring Frequency for Hard rock slopes including Ruin Granite and Diabase.

Table 3. Minimum Monitoring Frequency for engineering soils include Whitetail Conglomerate, and soil slopes on the west wall

Table 4. Minimum Monitoring Frequency for failing slopes including the south wall slide (old schist slide)

Table 5. Recommended Radar Alarm Settings for SSR026 - South, East and West Walls. Reviewed March 4, 2020 ECW

Table 6. Recommended Radar Alarm Settings for SSR189 - East and North Walls. Reviewed March 4, 2020 ECW

Table 7. Geotechnical Trigger Action Response Plan - Hard rock slopes

**Table 2. Minimum Monitoring Frequency for Hard rock slopes including Ruin Granite and Diabase.**

Operational Status	Slope Velocity (in/day)	Inverse Velocity (day/in)	Visual Inspection	Extensometers	Crack Mapping	Prism Survey	Piezometer Readings
Active Mining	< 0.1	> 10	Daily	Weekly	Monthly	Monthly	Monthly
	0.1 - 0.75	10 - 1.3	Daily	Daily	Weekly	2 x Month	Monthly
	0.75 - 2	1.3 - 0.5	Shift	Daily with recorder	Weekly	Weekly	Weekly
	> 2	<0.5	Radar and/or Spotter	Twice Daily with recorder	Daily	Daily	2 x Week
	<b>Exception</b>		Radar and Spotters based on risk assessment				
Inactive	< 0.1	> 10	Weekly	Monthly	Monthly	Monthly	Monthly
	0.1 - 0.75	> 10	Weekly	Weekly	Monthly	Monthly	Monthly
	0.75 - 2	> 1.3	Daily	2 x week with Recorder	Weekly	2 x Month	Monthly
	2 - 6	> 0.5	Daily	Daily with recorder	2 x Week	Weekly	Weekly
	> 6	< 0.2	2 x Day	Daily with recorder	Daily	Daily	2 x week

**Table 3. Minimum Monitoring Frequency for engineering soils include Whitetail Conglomerate, and soil slopes on the west wall**

<b>Operational Status</b>	<b>Slope Velocity (in/day)</b>	<b>Inverse Velocity (day/in)</b>	<b>Visual Inspection</b>	<b>Extensometers</b>	<b>Crack Mapping</b>	<b>Prism Survey</b>	<b>Piezometer Readings</b>
Active Mining	< 0.2	> 5	Daily	Weekly	Monthly	Monthly	Monthly
	0.2 - 1.5	5 - 0.7	Daily	Daily	Weekly	2 x Month	Monthly
	1.5 - 4	0.7 - 0.25	Shift	Daily with recorder	Weekly	Weekly	Weekly
	> 4	<0.25	Radar and/or Spotter	Twice Daily with recorder	Daily	Daily	2 x Week
Inactive	< 0.2	> 5	Weekly	Monthly	Monthly	Monthly	Monthly
	0.2 - 1.5	> 5	Weekly	Weekly	Monthly	Monthly	Monthly
	1.5 - 4	> 0.7	Daily	2 x week with Recorder	Weekly	2 x Month	Monthly
	4 - 12	> 0.25	Daily	Daily with recorder	2 x Week	Weekly	Weekly
	> 12	<0.05	2 x Day	Daily with recorder	Daily	Daily	2 x week

**Table 4. Minimum Monitoring Frequency for failing slopes including the south wall slide (old schist slide)**

Operational Status	Slope Velocity (in/day)	Inverse Velocity (day/in)	Visual Inspection	Extensometers	Crack Mapping	Prism Survey	Piezometer Readings
Active Mining	< 0.4	> 2.5	Daily	Weekly	Monthly	Monthly	Monthly
	0.4 - 3	2.5 - 0.3	Daily	Daily	Weekly	2 x Month	Monthly
	3 - 8	0.3 - 0.125	Shift	Daily with recorder	Weekly	Weekly	Weekly
	> 8	<0.125	Radar and/or Spotter	Twice Daily with recorder	Daily	Daily	2 x Week
Inactive	< 0.4	> 2.5	Weekly	Monthly	Monthly	Monthly	Monthly
	0.4 - 3	> 2.5	Weekly	Weekly	Monthly	Monthly	Monthly
	3 - 8	> 0.3	Daily	2 x week with Recorder	Weekly	2 x Month	Monthly
	8 - 24	> 0.125	Daily	Daily with recorder	2 x Week	Weekly	Weekly
	> 24	<0.05	2 x Day	Daily with recorder	Daily	Daily	2 x week

**Table 5. Recommended Radar Alarm Settings for SSR026 - South, East and West Walls. Reviewed March 4, 2020 ECW**

		Urgent Alarms (Red)			Geotechnical Alarms (Orange)			
		Deformatic	Velocity		Coherence	Inverse Velocity	Tracking	Velocity Ratio
Zone	Description	in / 24 hours	in/day	time period (over hours)		day/in		
0	Schist Hill (not in Radar View)							
1	Old Schist Slide	8	x	x		0.125		
2	Above Haul Road below Castle Dome Road	2	2	4		0.5		
3	Above Haul Road South Foothills	2	2	6		0.5		
4	East of Gemini Fault Below Haul Road	2	2	6		0.5		
5	West of Gemini Fault Below Haul Road	2	2	6		0.5		
6	West Wall	2	2	6		0.5		
7	Below Haul Road in Pit Bottom	2	2	6		0.5		
8	Pit Bottom	2	2	6		0.5		

**Table 6. Recommended Radar Alarm Settings for SSR189 - East and North Walls. Reviewed March 4, 2020 ECW**

		Urgent Alarms (Red)			Geotechnical Alarms (Orange)			
		Deformatic	Velocity		Coherence	Inverse Velocity	Tracking	Velocity Ratio
Zone	Description	in / 24 hours	in/day	time period (hours)		day/in		
A	Northwest Wall	2	2	4		0.5		
B	Northeast Wall above Haul Road	2	2	4		0.5		
C	Diabase / Granite Porphyry above Haul Road	2	2	4		0.5		
D	Limestone/Granite above Haul Road	2	2	6		0.5		
E	Fill, Granite, forest line southeast	2	2	6		0.5		
F	East Pit Wall below haul Road	2	2	6		0.5		
G	Mid east pit wall below haul road	2	2	6		0.5		
H	Southeast pit wall below haul road	2	2	6		0.5		

**Table 7. Geotechnical Trigger Action Response Plan - Hard rock slopes**

Operational Status	Slope Velocity (in/day)	Alert Level	Action by site Geotechnical Engineer	Mine Department / Technical Services Manager	Mine Manager	General Manager
Active Mining	< 0.1	Normal Operations	Routine Monitoring	No Action Required	No Action Required	No Action Required
	0.1 - 0.75	Normal Operations / increased monitoring	Increase monitoring frequency and locations, develop and implement analysis plan or field investigation plan as appropriate, inform mine department.	Informed daily-weekly. Approve analysis and/or field work plan.	Informed as determined by tech services.	Informed, as determined by mine manager.
	0.75 - 2	Geotechnical	Estimate of projected failure limits, volume and potential timing, Identify hazard areas and inform mine department.	Develop mine plan alternatives. Estimate economic loss potential.	Review and advise on mine plan alternatives and present to GM.	Informed, provide update to Capstone Corporate for potential multibench wall failures that have the potential to change the mine plan.
	> 2	URGENT (Alarm)	Close area for mining and all access. Detailed analysis of failure mechanism and limits, estimate time to failure)	Implement mine plan alternatives. Close area for mining and access until rate decreases to a normal operations threshold, or a detailed risk assessment and Job Safety Analysis (JSA) can be completed for safe work in the area.	Implement mine plan alternatives. Close area for mining and access until rate decreases to a normal operations threshold, or a detailed risk assessment and Job Safety Analysis (JSA) can be completed for safe work in the area.	Update to Capstone Corporate and advise on expected failure impacts and revised mine plan.
		Alarm Exception / Override	Provide detailed analysis of failure mechanisms, expected displacement rates, estimated hazard, and consequence. Estimate if there are feasible options to continue mining with movement. Solicit independent review and analysis.	Evaluate economics of failure and consequence to ore reserve. Conduct detailed risk assessment process (Risk = likelihood x consequence). Recommend safe options to continue mining and develop JSA if economic and feasible mining options are available.	Review project economics, risk assessment, and JSA,s and make a recommendation to GM and Capstone.	Review and Approval of risk assessment and alternative mining plan in hazard area.

For inactive mining areas - areas should be barricaded and closed with no-entry prior to geotechnical inspection

## Radar Zone Locations for Urgent Alerts SSR026

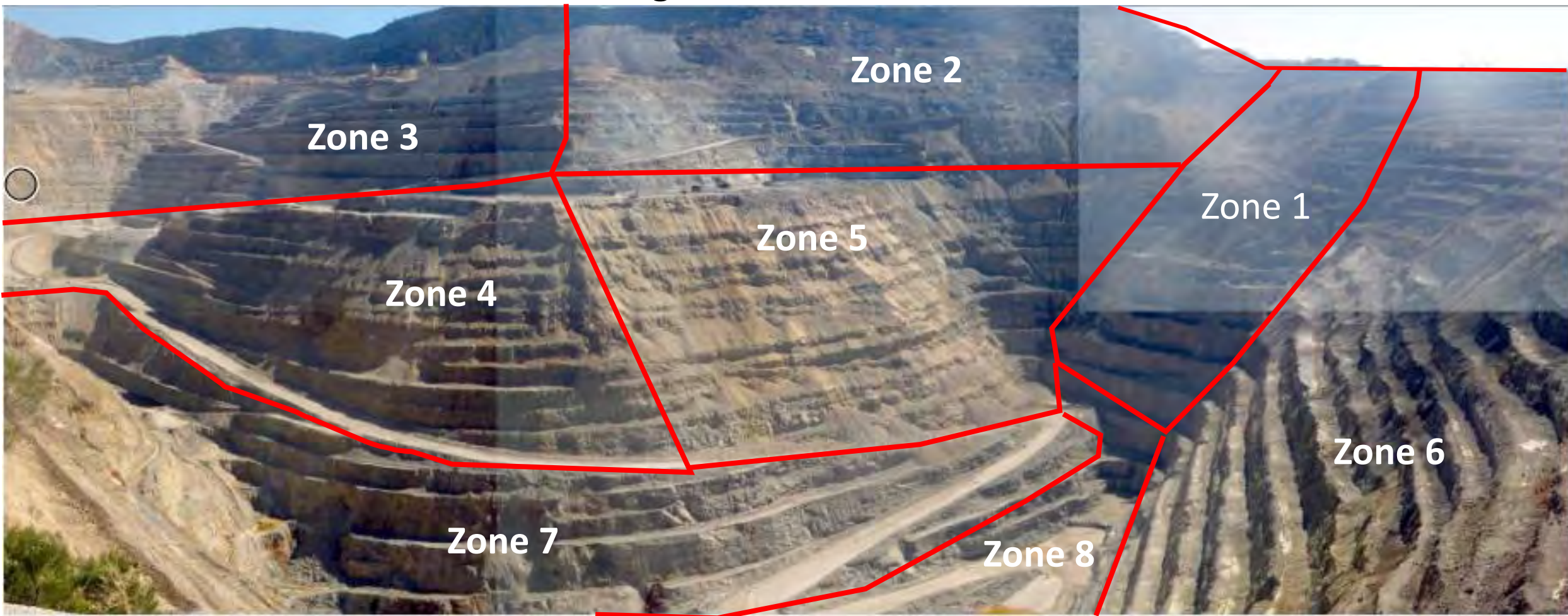

Zone 1 – Old Schist Slide

Zone 2 – Above Haul Road below Castle Dome Road

Zone 3 – Above Haul Road South Foothills

Zone 4 – East of Gemini Fault below haul road

Zone 5 – West of Gemini Fault below haul road

Zone 6 – West Wall

Zone 7 – Below Haul Road to Pit Bottom

Zone 8 – Pit Bottom

\* All zones are approximate locations



# Radar Zone Locations for Urgent Alerts SSR189

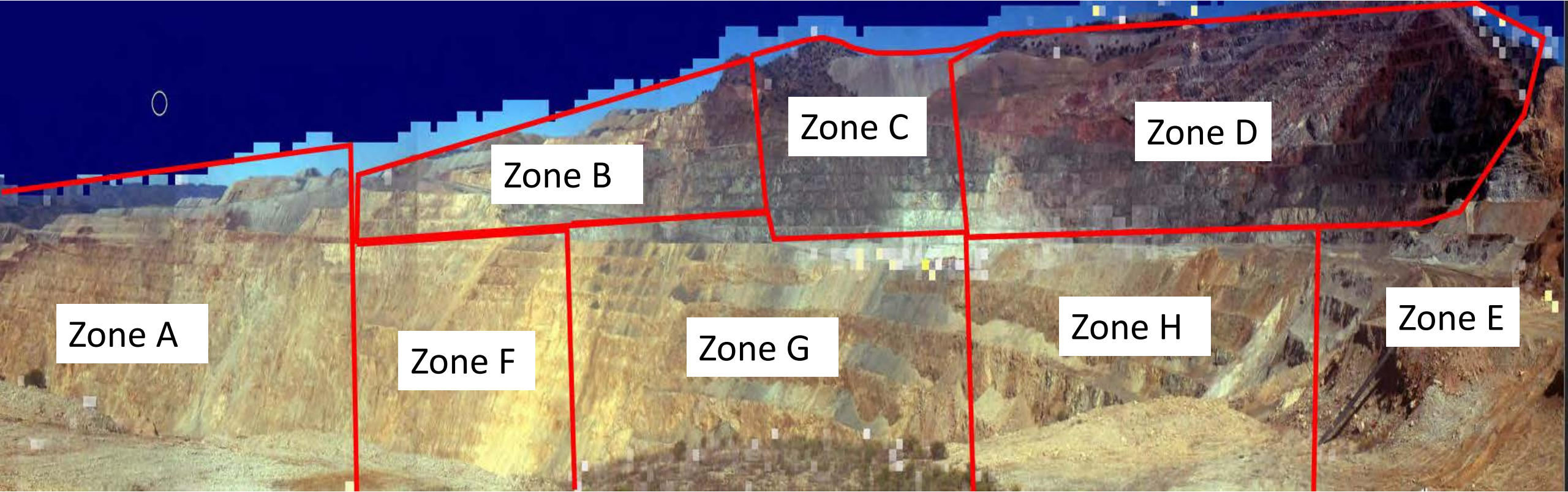

Zone A – Northeast Wall  
Zone B – Northeast Wall above haul road  
Zone C – Diabase/granite Porphyry above haul road  
Zone D – Limestone/Granite above haul road

Zone E – Fill, granite, forest line southeast  
Zone F – East Pit Wall below haul road  
Zone G – Mid east pit wall below haul road  
Zone H – Southeast pit wall below haul road

\* All zones are approximate locations



## **ATTACHMENT C: POST-CLOSURE STORMWATER CONTROL, INSPECTION, AND MAINTENANCE PLAN**



**Post-Closure Tailings Stormwater Control,  
Inspection and Maintenance Plan**

**Tailings Storage Facilities No. 3 and No. 4**

**Pinto Valley Mine  
Miami, Arizona**

## **1.0 INTRODUCTION**

A ten-year settlement period has been forecast from the completion of tailings deposition to the start of the earthwork activities on the surface to accommodate draindown of fluids within the deposited tailings and the associated calculated consolidation of the tailing impoundment surface. During this ten-year period, active management of the piezometer and deformation monitoring system, supernatant pools, seepage collection impoundments, stormwater and erosion controls will be managed under the practices and permit requirements of the active Pinto Valley Mine operation, as summarized in Section 1.1. Closure of the facilities is expected to take another three-years.

The post-closure inspection and maintenance mitigation measure will begin at the conclusion of closure and reclamation. This document describes the inspection and maintenance activities that would be performed after closure grading and construction of reclamation-related stormwater controls have been completed. Upon final closure, PVMC will prepare a Final Post-Closure Inspection and Maintenance Plan manual with additional details including information such as roles and responsibilities of site personnel, site health and safety permit requirements and any reference materials and documents that will support the manual. A 30-year post-closure monitoring and maintenance period was selected based on an expectation that reclaimed facilities will reach a stable condition, and vegetation will have matured to a natural-looking community within 30 years.

### **1.1 Background**

During the operational life of the mine, a closure strategy is maintained to provide enough detail to establish the required financial assurance to secure the reclamation activities. The current Closure and Post-Closure Strategy (SRK, 2019) was based on impoundment-specific closure designs for TSF3 (Wood, 2018) and TSF4 (Amec, 2017).

The current Pinto Valley Mine Aquifer Protection Permit (APP) (ADEQ, 2019) requires a closure plan be developed within 90 days following notification of closure that details the methods to obtain a clean closure at the end of mining pursuant to ADEQ regulations.

In accordance with the facility APP permit (ADEQ, 2019) closure approval will be issued by ADEQ for a facility if the following conditions are met:

- The closure complies with all the terms of the facility's Aquifer Protection Permit
- The closure eliminates all discharges from the facility to groundwater to the greatest degree practical
- There is no reasonable probability that discharges from the facility will exceed Aquifer Water Quality Standards (AWQS) at the applicable points of compliance

The financial assurance required under the APP for PVM has been established by Pinto Valley Mining Corp. (PVMC) and is maintained in accordance with the permit requirements.

The closure methodology outlined in the Closure and Post-Closure Strategy (SRK, 2019) consists of initially establishing the physical setting and climate parameters for the entire site. These parameters set the baseline for development of general design criteria for common elements addressed in mine closure, such as stormwater controls but also control of acid-generating materials, slope stability, cover

requirements, impoundment closures, ancillary facility closures, road and pipeline closures, structure demolition, and perimeter security. The general design criteria are used to develop the strategy for specific facilities located at PVM, in addition to stormwater control at the TSFs. The strategy also discusses long-term maintenance and monitoring in the post-closure period and is intended to be updated, as needed, through the remaining mine life, as additional information is developed or as facilities are modified, decommissioned, or reclaimed and closed. As required by the Arizona Aquifer Protection Permit program, more detailed closure plans will be developed for specific facilities, either as a component of a site-wide closure plan or for interim closure plans if needed during the life of the mine. As required by the Arizona Mined Land Reclamation program, PVMC's Mined Land Reclamation Plan (SRK, 2016) will also be updated when substantive changes are made to the existing facilities and new facilities and disturbance are proposed, and/or to reflect the change of selected facilities to a post-closure status prior to final site-wide closure.

TSF draindown will take approximately 10 years after closure before reclamation can commence. Following draindown, re-contouring of the TSFs will be performed by bulldozers, which will be used to lessen the slopes by pushing up-slope material down the slope or pulling down-slope material up the slope to create a shallower slope angle. The tops of the TSFs will be re-contoured to promote drainage and prevent water from ponding. Following the removal or demolition of water-handling facilities and the completion of re-contouring, a soil and vegetation cover will be placed on the top and side slopes of the TSFs. Seed will be either broadcast simultaneously with the fertilizer, drilled with farm equipment, or applied with a hydroseeder/hydromulcher. The portions of TSF3 and TSF4 located on USFS administered lands (NFS lands) would be closed at roughly the same time. Surface drainage control associated with the reclaimed TSFs will be provided after closure of the facility. The existing TSF catchments and ditches below the toe of the TSFs will be closed in a manner consistent with post-closure seepage collection and stormwater control objectives, which will include diversion of run-on stormwater. Ditches that remain open for stormwater diversion will be inspected and maintained, as needed. Earthwork maintenance will be performed, as necessary, to ensure that the ditches continue to function according to design. Ponds and ditches no longer necessary will be closed by cutting and filling to promote drainage through these areas.

In the post-closure period, the TSFs will be inspected monthly initially following the conclusion of reclamation earthworks and at a decreasing frequency into the post-closure period to monitor erosion and vegetation. In addition, the re-established drainages will be inspected after major rainfall events to make sure the retained stormwater diversions and riprap spillways are working properly. Seepage handling facilities will be subject to routine on-going maintenance.

In addition to the APP requirements, this plan provides additional post-closure stormwater control planning based on the analysis and impacts to NFS lands identified in the EIS. In accordance with the mandate for the U.S. Forest Service (USFS) to protect surface resources, the USFS will have review and approval authority for the portions of this plan that address post-closure stormwater control on NFS lands.

## **1.2 Purpose and Objectives**

The purpose of this Post-Closure Tailings Stormwater Control, Inspection and Maintenance Plan is to:

- Describe the post-closure stormwater control plan for TSF3 and TSF4 – Section 2 of this document describe these plans for TSF3 and TSF4, respectively.

- Describe the Operation, Maintenance and Surveillance (OMS) components of the post-closure stormwater plan – Sections 3 and 4 of the document describe the inspections that will be performed. Section 5 describes the maintenance requirements.
- Identify triggers for maintenance and mitigation for the post-closure storm water controls – The indicators which would trigger maintenance or repair activities are described in Section 5 of the document.
- Describe the agency reporting requirements for the post-stormwater controls – Section 6 of the document presents the documentation of the maintenance activities and the regulatory reporting requirements.
- Additional information about operations during closure and post-closure can be found in the Post-Closure Tailings Seepage Management and Mitigation Plan (SRK, 2020).

### **1.3 Post-Closure Stormwater Control Plan Duration**

The post-closure care period under the ADEQ APP permit for the Pinto Valley Mine tailings storage facilities is 30-years, as defined by the facility's APP. As mentioned above, a 30-year post-closure monitoring and maintenance period was selected based on an expectation that reclaimed facilities will reach a stable condition, and vegetation will have matured to a natural-looking community within 30 years. This timeframe is consistent with Resource Conservation and Recovery Act regulatory requirements for solid waste facilities. Incidental inspections and maintenance may be required after the post-closure period.

## **2.0 POST-CLOSURE STORMWATER CONTROL PLAN**

Surface water management following the closure of TSF3 and TSF4 has been evaluated and is presented in the attached conceptual closure designs (SRK, 2019).

PVM will maintain a Stormwater Pollution Prevention Plan (SWPPP) with control measures and Best Management Practices (BMPs) for the facility, including the closed TSF3 and TSF4. This SWPPP will be regularly updated in accordance with the requirements of the State of Arizona, Department of Environmental Quality (ADEQ) *AZPDES General Permit for Stormwater Discharges Associated with Industrial Activity – Mineral Industry to Waters of the United States*.

### **2.1 TSF3 Closure Plan Description**

TSF3 is an existing tailings facility currently in use at PVM as the backup tailings disposal facility, used during upset conditions or during maintenance of the TSF4 tailings distribution system. The planned expansion of the existing TSF3 is to a maximum crest elevation of 3857 feet by extension onto NFS lands.

Closure of TSF3 will commence at the end of the project life after the majority of tailings dewatering and the associated consolidation has occurred, calculated to 10 years after last tailings deposition. A drawing of the conceptual TSF3 closure design is attached to this mitigation plan. The TSF3 downstream embankment face will be regraded to a 3H:1V interbench slope and covered with 2 feet of cover material followed by 6 inches of rock armor fill. The TSF3 top surface will be graded at a minimum 1% slope and



covered with a minimum of 12 inches of cover material which will be revegetated with an approved seed mix. Side slopes will be regraded to a minimum 3.0H:1V and covered by 2 feet of cover material followed by 6 inches of rock armor fill.

The TSF3 top bench stormwater diversion channels (BC3-1 and BC3-2) will connect to a drop channel (DC3-1) on the northeast side of the TSF3 embankment to discharge stormwater to a northern perimeter stormwater run-on interceptor channel and existing ponds. This water will be discharged to a natural drainage when reclamation has been completed. Another top surface stormwater channel (IC3-1) will be constructed to eventually discharge to the natural drainage via a spillway on the western side of the impoundment following full reclamation.

Riprap with a D50 of 6-inches is necessary to protect the impoundment and bench channels. Riprap with a D50 of 24 inches is necessary to protect the drop channels. The use of articulated concrete blocks can be considered as an alternative lining as these are capable of resisting high design velocities.

A TSF3 top bench stormwater diversion channel will connect to a drop channel on the northeast side of the TSF3 embankment to discharge stormwater to a northern perimeter stormwater run-on interceptor channel and existing ponds. This water will eventually be discharged to the Gold Gulch drainage when reclamation has been completed. A top surface stormwater channel will be constructed to eventually discharge to the natural drainage via a spillway on the western side of the impoundment following full reclamation.

Seepage from the embankment underdrains will be captured by the existing collection system located at the No. 3 Seepage Caisson, West Catchment, East Catchment, and East Catchment Caisson. Fluids will be collected, and a pump will be housed to convey those fluids to their ultimate location for the post-closure period (Wood, 2018).

## **2.2 TSF4 Closure Plan Description**

TSF4 is an existing tailings facility currently in use at PVM as the primary tailings disposal facility. The TSF4 embankment face below elevation 3790 feet has been already reclaimed with a minimum 2-foot-thick soil cover protected with 6 to 13 inches of rock armor, depending upon slope angle and location on the slope.

The planned expansion of the existing TSF4 is to a maximum crest elevation of 4250 feet by extension onto NFS lands. To access the portion of TSF4 extending onto USFS lands, a new perimeter road will be constructed around the proposed final footprint of the facility. Excess material from road cuts will be stockpiled for use as cover materials during final reclamation.

Closure of TSF4 will commence approximately 10 years after placement of the final tailings to allow for tailings consolidation. The TSF4 downstream embankment face will be regraded to a 3.0H:1V or flatter inter bench slope and covered with 2 feet of cover material followed by 6 inches of rock armor fill. The TSF4 top surface will be graded at a minimum 2% slope and covered with a minimum of 12 inches of cover material and will be revegetated with an approved seed mix. Side slopes will be regraded to a maximum 3.0H:1V and covered by 2 feet of cover material followed by 6 inches of rock armor fill. The perimeter roadway that will be located on the east side of TSF4, on USFS lands will remain in service. A drawing of the conceptual TSF4 closure design is attached to this mitigation plan.

In order to achieve a cascading or slope grading toward the spillway outlet, the proposed design calls for closing the tailings impoundment surfaces in separate cells, including Cell A – northern cell; Cell B – middle

cell; and Cell C – southern cell. These cells will be constructed during the last years of the operational life of the facility. Prior to ceasing operations, two divider berms will be constructed between Cells A and B and between Cells B and C, allowing independent deposition and reclamation of tailings in each cell. Upon cessation of operations, the ultimate tailings impoundment will have a terraced surface generally sloping toward the northwest corner of the TSF where the spillway outlet will be located. This zoned deposition and closure concept will allow for a staged tailings surface at closure, and lead to a significant reduction in earthwork required for construction of impoundment channels and a spillway outlet to drain post-closure runoff from the impoundment surface.

The closure drainage design for TSF4 includes a system of collection and conveyance channels that will collect stormwater flows from the top surface of the impoundment and direct flows to a spillway located on west embankment face for conveyance to lower Eastwater Canyon when TSF4 is fully reclaimed.

Prior to the placement of the cover materials, tailings surfaces, slopes, and benches will be regraded to promote stormwater drainage toward channels and outlets. The downstream slope of the embankment will be regraded to 3H:1V overall. Four bench channels (BC4-1 through BC4-4) will be constructed on the downstream slope of the embankment to collect stormwater runoff and divert flow from the surface of the slope to the edges of the embankment and off the facility. BC4-2 and BC4-4 will connect with DC4-1 on the eastern edge of the embankment. Two channels (IC4-1 and IC4-2) will be constructed on the surface that connect and direct flow to a spillway on the western edge. The spillway will discharge to a native drainage.

Riprap with a D50 of 6-inches is necessary to protect some portion of the impoundment and bench channels. Riprap with a D50 of 18 inches is necessary to protect the bench channels. Concrete lined channels will be used to protect the drop channels. The use of articulated concrete blocks can be considered as an alternative lining for the drop channels as these are capable of resisting high design velocities.

Any seepage daylighting at the downstream toe of the TSF will be captured in the existing ponds throughout the post-closure period (Amec Foster Wheeler, 2017).

### **3.0 ANNUAL INSPECTIONS**

An inspection of the stormwater controls of the closed TSFs will be performed annually by a professional civil engineer, specializing in geotechnical engineering, and experienced with the design, operation and closure of TSFs. The engineer will be registered by State of Arizona Board of Technical Registration.

The inspection will evaluate if any unusual or abnormal conditions are present at the TSFs including, but not limited to the following:

- Erosion of the cover system
- Animal burrows or other intrusions
- Depressions or ponded water on the surface of the TSF
- Cracking of the impoundment top surface or embankment cover system
- Displacement or soil creep of cover systems
- Sinkholes forming on the embankment or impoundment top surface
- Flood damage to channels, including displacement of riprap or erosion/scour control products
- Erosion of stormwater outfalls
- Concrete deterioration or damage at drop structures

Post-Closure Tailings Stormwater Control, Inspection and Maintenance Plan  
Tailings Storage Facilities No. 3 and No. 4

- Vegetation blockage of channels and stormwater inlets
- Sediment blockage of channels and stormwater inlets
- Vandalism or other intentional damage
- Other abnormal conditions

Any abnormal condition observed will be evaluated and a maintenance activity or repair project to mitigate any abnormal or deficient condition will be defined as described in Section 5. Any necessary repair or construction project drawings, specifications and quality control program will be defined and submitted to the ADEQ and USFS for approval of the agencies. The maintenance activity or repair would be implemented promptly upon receipt of approval.

Emergency repairs that could prevent further damage of the stormwater control systems that are performed in advance of authorization should be fully documented and that information provided to the relevant agency.

The post-closure use of the TSFs is unknown at the time of this plan preparation. Any post-closure uses of the TSFs within the PVM property boundary will be in accordance with appropriate state and local regulations.

A copy of the annual inspection report, along with recommended maintenance or repairs will be prepared by the inspection engineer and provided to the facility manager within 30-days of the inspection date.

#### **4.0 SPECIAL INSPECTIONS**

After a major precipitation event, defined as an event with greater than or equal to 3 inches in 24 hours (e.g. a 5 year storm event), slopes, ditches, culverts, groin areas, stormwater check dams, pipes and ponds, around the tailing storage facilities will be inspected by a geotechnical engineer. Work orders will be written for any necessary maintenance and repair activities following the process defined in Section 6.2.

After a major precipitation event, the TSF will be also be evaluated for erosion. The facility manager will write work orders to repair the erosion features in a timely manner, depending on the severity. Until the repairs are executed, the facility manager may authorize more frequent field inspections to ensure the erosion features are repaired and do not progress in the case of a subsequent rain event.

A copy of the special inspection report, along with recommended maintenance or repairs will be prepared by the inspection engineer and provided to the facility manager within 30-days of the inspection date.

#### **5.0 MAINTENANCE**

Areas of the cover system that have been eroded will be backfilled. Those areas will be protected with erosion control waddles or matting to deter new erosion. Adjacent areas surrounding the covered area that have been eroded will be graded to allow positive drainage and protected with erosion control waddles or matting to deter new erosion.

The facility manager will stipulate site-specific vegetation allowances. Vegetation on the closed tailings dams is permissible with the following considerations:

- Dam safety concerns override environmental and operational issues/activities

- Do not allow vegetation where it may negatively impact (e.g., root intrusion) local critical areas such as drains, liners, berms, drain outfalls, ditches, access ramps and instrumentation
- Remove vegetation that prohibits adequate visual inspections

If undesirable vegetation is identified within the stormwater controls, the facility manager will prepare and execute a maintenance work order using the repair order process defined in Section 6.

Other event-based maintenance is defined as a non-routine maintenance that is necessitated by conditions including but not limited to earthquakes, embankment slumps, or observed cracks, sinkholes, or seepage on the face of the embankments. The facility manager schedules non-routine maintenance activities as necessary.

Activities include, but are not limited to; maintaining slopes, controlling vegetation and grading roads. As mentioned previously, routine inspections may indicate the need of event-driven maintenance. After an event-based inspection, the repair order process described in Section 6 is used to report, track and address the required maintenance.

## **6.0 DOCUMENTATION AND REPORTING**

### **6.1 Repair Order Documentation**

Regularly scheduled maintenance of post-closure stormwater control components at the TSFs will be coordinated through a maintenance work order system. Maintenance work orders are created and tracked using an asset management and maintenance system, such as SAP. The system will be updated using the results of the facility inspections to plan maintenance activities. Typical steps in the work order management include:

- The facility manager establishes what work is needed and discusses with any specialists for proper understanding of the work to be completed
- After the work is planned and scheduled, a work order is presented to the person or firm responsible to carry into the field
- Upon completion of the job, the person or firm responsible acknowledges the completed the work order with completion comments for a maintenance activity or a completion report for a repair project
- Once the facility manager verifies that the work has been satisfactorily completed, the work order is closed
- A copy of the repair order documentation is archived

### **6.2 Regulatory Reporting**

Reports will be prepared by the post-closure facility manager to document the post-closure stormwater control inspections and maintenance activities.

The facility manager will prepare, or authorize the preparation of, an annual report to the ADEQ and USFS presenting the results of the inspections for the preceding year. A description of the maintenance and any repairs to the TSF3 and TSF4 stormwater controls will be described in the report.

## **7.0 ADAPTIVE MANAGEMENT**

The focus of the inspections will vary depending on the current operational challenges at the facility, but a program of adaptive management will consist of at least the following elements:

- Review action items from the previous inspection
- Visit problematic areas reported by the facility manager and any site maintenance personnel
- Complete inspections of the tailings impoundments and embankment cover systems, seepage collection systems, stormwater channels and perimeter roadway, at least on an annual frequency

Conditions that have changed from the previous inspection are evaluated and discussed with the facility manager for additional action or increased frequencies of monitoring, as necessary.

Post-Closure Tailings Stormwater Control, Inspection and Maintenance Plan  
Tailings Storage Facilities No. 3 and No. 4

**References:**

Amec Foster Wheeler Environment & Infrastructure, Inc., 2017, Conceptual Reclamation Design, Tailings Storage Facility No. 4 Extension, Pinto Valley Mine, Gila County, Arizona, Amec Project No. 17-2016-4039, dated March 28.

State of Arizona, Department of Environmental Quality (ADEQ), 2019, Significant Amendment to Aquifer Protection Permit No. P-100329, Place ID 838, LTF 78425, dated October 21.

SRK Consulting, Inc., 2016, Mined Land Reclamation Plan, Pinto Valley Mining Corp., dated January 26.

SRK Consulting, Inc., 2019, Closure Strategy and Post-Closure Strategy, Pinto Valley Mine, dated September 30.

SRK Consulting, Inc., 2020, Post-Closure Tailings Seepage Management and Monitoring Plan, Pinto Valley mine, dated July 10.

U.S. Forest Service (Forest Service), 2019. Pinto Valley Mine Draft Environmental Impact Statement, dated December 13.

Wood Environment & Infrastructure Solutions, Inc., 2018, Conceptual-Level Reclamation Design, Pinto Valley Mine, Tailings Storage Facility No. 3, Gila County, Arizona, Wood Project No. 17-2018-4045, dated December 21.

**Pinto Valley Mine  
 Post Closure Tailings Stormwater Controls  
 Inspection Components Table**

<b>Item</b>	<b>Indicators</b>	<b>Inspection and Maintenance Consideration</b>
Impoundment and Embankment Cover Systems	<ul style="list-style-type: none"> <li>• Erosion of cover system</li> <li>• Signs of movement (sliding, slumping, subsidence and cracking)</li> <li>• Seepage or saturated surface on embankment</li> <li>• Animal burrow holes</li> <li>• Excessive vegetation on impoundment or embankment</li> <li>• Ponded water on cover system or embankment benches</li> </ul>	<p>Photographs should be taken to document and benchmark the condition</p> <p>Repairs as necessary</p> <p>Increase inspection frequency if repairs are not executed promptly</p>
Stormwater Controls	<ul style="list-style-type: none"> <li>• Erosion of berms</li> <li>• Infilling of control with wind-blown or water-conveyed sediments</li> <li>• Obstructed culverts</li> </ul>	
Stormwater Channels	<ul style="list-style-type: none"> <li>• Erosion of channel</li> <li>• Displaced riprap or erosion control mats</li> <li>• Accumulated sediment within the channels</li> </ul>	
Perimeter Road	<ul style="list-style-type: none"> <li>• Excessive erosion, rutting and cracking</li> <li>• Obstructed culvert pipes</li> <li>• Instability of adjacent cut and fill slopes</li> </ul>	<p>Regrade and re-establish stormwater controls to meet or exceed design requirements</p>

Mitigation Plan GM-3a  
Post-Closure Tailings Stormwater Control Inspection and Maintenance Plan  
Tailings Storage Facilities No. 3 and No. 4

**Tailings Storage Facility No. 3  
Conceptual Closure Plan**



## Technical Memorandum

**To:** Pinto Valley Mining Corp.  
**Attn:** Tim Ralston, CHMM, REM  
Manager Land, Permitting & Regulatory Affairs

**File No:** 17-2018-4045

**From:** Maren Henley, PE  
Senior Geological Engineer

**Reviewed:** Tony Freiman, PE  
Principal Geotechnical Engineer

**Tel:** (602) 733-6000

**cc:** File

**Date:** December 21, 2018

**Re:** Conceptual-Level Reclamation Design  
Pinto Valley Mine  
Tailings Storage Facility No. 3  
Gila County, Arizona



### 1.0 INTRODUCTION

This Technical Memorandum presents the conceptual plan for closure and reclamation of Tailings Storage Facility No. 3 (TSF3) and was developed to support the Aquifer Protection Permit Amendment Application and other environmental permit-related reviews.

The reclamation designs presented in this Technical Memorandum are conceptual and were developed in consultation with the "Pinto Valley Operations Closure and Post-Closure Strategy (SRK, 2016b; herein referred to as the Closure Strategy) and "2016 Mined Land Reclamation Plan" (SRK, 2016a; herein referred to as the 2016 MLRP). A final closure plan will be developed in advance of cessation of operations. Reclamation activities will be conducted to the standards adopted by the Arizona Department of Environmental Quality Best Available Demonstrated Control Technologies (BADCT) (ADEQ, 2004), and State of Arizona (Arizona State Mine Inspector, 1997 and 2008) and generally follow the Closure Strategy and 2016 MLRP.

### 2.0 CLOSURE CONCEPT FOR TSF3

TSF3 will be closed in a manner that will eliminate hazardous conditions for future land usage, inhibit erosion and minimize adverse impacts to the environment. After deposition ceases, TSF3 will be monitored for approximately 10 years to allow for draindown, settlement, and evaporation at the surface such that equipment can be operated for construction.

The preferred conceptual-level alternative is to slope the ultimate tailings surface from east to west, directing all surface water to a spillway constructed on the west side TSF3. In accordance with the Closure Strategy, all tailings storage facilities will not store fluids after closure.



A second conceptual-level alternative, which may be evaluated at the time of closure, is to slope the ultimate tailings surface such that water is directed from west to east, and then connects to the bench channel on the east side.

The TSF3 reclamation design incorporates the following components:

- Create a stable surface including embankment slopes;
- Maximize non-contact water runoff and minimize infiltration of direct precipitation;
- Provide post-closure containment of tailings; and
- Create a surface capable of sustaining the desired post-mining land use.

## 2.1 Water Management

The TSF3 top bench stormwater diversion channels (BC3-1 and BC3-2) will connect to a drop channel (DC3-1) on the northeast side of the TSF3 embankment to discharge stormwater to a northern perimeter stormwater run-on interceptor channel and existing ponds. This water will be discharged to a natural drainage when reclamation has been completed. Another top surface stormwater channel (IC3-1) will be constructed to eventually discharge to the natural drainage via a spillway on the western side of the impoundment following full reclamation.

To calculate discharges to size the channels, a 100-year 24-hour event was used as a design storm, plus a 1-foot freeboard. The design discharges were obtained from the HEC-HMS model developed for the Pinto Valley Phase 2 extension project (AMEC, 2014). RE-001 shows the plan view of the channels designed. The design flows are shown in Table 1 below.

**Table 1: Closure Channels Design Discharges**

Channel Section	Area (sq mi)	100-year Discharge (cfs)	500-year Discharge (cfs)
IC3-1	0.18	292	374
BC3-1	0.03	81	104
BC3-2	0.04	104	134
DC3-1 (Upper)	0.073	185	237
DC3-1 (Lower)	0.094	229	293

The channels were sized by normal depth methods by solving the Manning's Equation. A Manning's roughness coefficient of 0.03 was used for bare earth and 0.055 was used for 6-inch riprap.

The impoundment and bench channels were designed for a flow depth of approximately 2 feet and a longitudinal slope of 0.5 percent (%). The channels will be trapezoidal with 3:1 side slopes. Channel bottom widths were varied to keep the design flow velocities at the 100-year event to about 4 to 5 feet per second (fps). The drop channel has a design slope of 15%, 3:1 side slopes and less than a 2-foot flow depth.

Riprap with a D50 of 6-inches is necessary to protect the impoundment and bench channels. The design details are presented in RE-003. Riprap with a D50 of 24 inches is necessary to protect the drop channels. The use of articulated concrete blocks can be considered as an alternative lining as these are capable of resisting high design velocities and have been installed at other locations at the mine site.

A gravel filter layer will be required between the soil cover and the proposed riprap or articulated concrete block channel linings. The gravel filter will consist of a 4" layer of Type I bedding and a 6" layer of Type II

bedding, as defined in Chapter 6 of the Flood Control District of Maricopa County (FCDMC) Drainage Design Manual, Volume II – Hydraulics (FCDMC, 2013).

In general, the channels are designed to convey the 100-year flow with at least 1 foot of freeboard and contain the 500-year flows within the channel freeboard.

The post-closure channel design parameters, flow depth and velocities are summarized in Tables 2 and 3.

**Table 2: Closure Channels Design Flows and Depths**

Channel	Design (100-yr) Flow (cfs)	*Design Flow Depth (ft)	500-yr Flow (cfs)	500-yr Flow Depth (ft)
IC3-1	292	2.4	374	2.7
BC3-1	81	2	104	2.2
BC3-2	104	1.9	134	2.2
DC3-1 (Upper)	185	1.4	237	1.6
DC3-1 (Lower)	229	1.4	293	1.6

\*Note: Velocity is for a 'bare earth' condition and used to size riprap. Design depth is based on the lined channel roughness.

**Table 3: Closure Channels Design Parameters**

Channel	Slope (ft/ft)	Freeboard (ft)	Total Depth (ft)	Bottom Width (ft)	Side Slopes (H:1V)	*Velocity (fps)
IC3-1	0.005	1.1	3.5	30	3	4.6
BC3-1	0.005	1	3	10	3	3.8
BC3-2	0.005	1.1	3	15	3	3.8
DC3-1 (Upper)	0.15	1.6	3	15	3	14.4
DC3-1 (Lower)	0.15	1.6	3	20	3	14.4

The drainage design accounts for post-operation settlement of tailings over time. In order to support the conceptual reclamation designs, preliminary consolidation analyses were performed to estimate post-operation settlements of tailings. The results of the preliminary analyses were used to aid in the diversion channel designs in the reclamation design. Regrading and capping would not be initiated until approximately 10 years after final deposition to allow tailings consolidation.

## 2.2 Cover Design

As part of the conceptual closure strategy, a cover will be placed over the tailings top surface and embankment slopes and will be sequenced such that the facility is covered over time. The cover is intended to reduce infiltration of precipitation and stormwater through the cover to the facility. The cover consists of non-acid generating soil, such as Gila conglomerate from designated borrows.

For the top surface, the cover is to be placed at a minimum depth of 1 foot over the tailings surface. For the embankment slope the cover is to be placed at a minimum depth of 2 feet over the tailings followed by a minimum depth of 6 inches of rock armor (rock armor sizing may vary, but typically is planned to have a mean grain size of 3 inches). The rock armor is to be placed to assist in reducing erosion from the slope cover. During final design, calculations shall be performed to size the rock armor based on surface water runoff flow during storm events for the designed slope length.

### **3.0 RECLAMATION CONSTRUCTION**

This section summarizes the main reclamation activities that are required to close TSF3. The conceptual reclamation designs are presented in Figures RE-001 through RE-003. The closure concept in the design is generally consistent with the other existing tailings storage facilities that are currently being closed or have been closed at the site. The reclamation design package includes the following:

- Figure RE-001 – “Tailings Impoundment Closure Storm Water Management Plan,” presenting the strategy for post-closure stormwater management;
- Figure RE-002 – “Tailings Impoundment Closure Profiles,” presenting alignments and profiles of stormwater channels; and
- Figure RE-003 – “Tailings Impoundment Closure Details,” showing typical sections and dimensions of channels.

As shown in the Figures, the main reclamation activities include, but are not necessarily limited to, the following:

- **Regrading:** The main embankment downstream slopes are to be regraded to 3H:1V (horizontal to vertical) (18.4 degrees) or flatter; the main embankment upstream face and divider berms slopes are to be regraded to 4H:1V (14.0 degrees) or flatter. The tailings impoundment surface is to be regraded to a minimum 0.5% slope so that runoff is directed toward corresponding channels and the spillway outlet;
- **Stormwater Control:** The impoundment channel (IC3-1), embankment bench channels (BC3- series), and drop channel (DC3-1 series) will be regraded. These channels will be constructed with the dimensions shown in Figure RE-003;
- **Placement of Soil Cover over Impoundment Surface:** A minimum of 12 inches of soil cover is to be placed over the impoundment surface;
- **Placement of Soil Cover and Erosion Cover over Embankment Slopes:** A minimum of 24 inches of soil cover is to be placed over main embankment slopes, followed by a minimum 6-inch rock armor fill to minimize potential erosion from a design storm event;
- **Placement of riprap protection in the channels and spillways** with the dimensions shown in Figure RE-003; and
- **Revegetation:** Revegetation is to be carried out after the placement of the vegetative cover and rock armor.

### **4.0 POST-CLOSURE MONITORING**

The proposed closure activities also include a monitoring program that consists of periodic inspections, pore pressure monitoring, and tailings settlement monitoring. This monitoring program is to be implemented during the closure and post-closure periods. Monitoring of piezometers and embankment settlement will take place during the 10-year draindown and settlement period. Evaluation of the piezometric conditions at that time may result in abandonment of piezometers when phreatic conditions determine that the TSF may be considered a landform rather than an impoundment. Both installation and abandonment of the monitoring instruments are included in the reclamation cost estimates, along with the effort required for monitoring and reporting.

## 5.0 REFERENCES

AMEC Environment & Infrastructure, Inc., 2014, *Design Report Prefeasibility Study, Tailings Storage Facility Expansions, Phase 2 Project*. August 21.

Arizona Department of Environmental Quality., 2004, *Arizona Mining Guidance Manual BADCT*, Publication #TB04-01.

Arizona State Mine Inspector, 1997. *Mined Land Reclamation Rules, Arizona Administrative Code, Title 11, Chapter 2*. March 31.

Arizona State Mine Inspector, 2008. *Mined Land Reclamation Statutes Article 1 Administration, Arizona Administrative Code, Title 27 Minerals, Oil and Gas, Chapter 5*. February 12.

Flood Control District of Maricopa County (FCDMC), 2013, *Drainage Design Manual for Maricopa County, Arizona, Hydraulics*.

SRK, 2016a. *2016 Mined Land Reclamation Plan*, prepared for Pinto Valley Mining Corp, by SRK Consulting (U.S.) Inc. January 26.

SRK, 2016b. *Pinto Valley Operations Closure and Post-Closure Strategy*. Unpublished plan prepared for Pinto Valley Mining Corp.

**FIGURES**



G:\Geotechnical\2018 Projects\17-2018-4045 Capstone\_TSF3 Embankment Reconfiguration\CAD\Figures\Tailings Impoundment Closure\RE-000\_TSF3.dwg-12/19/2018 10:13 AM

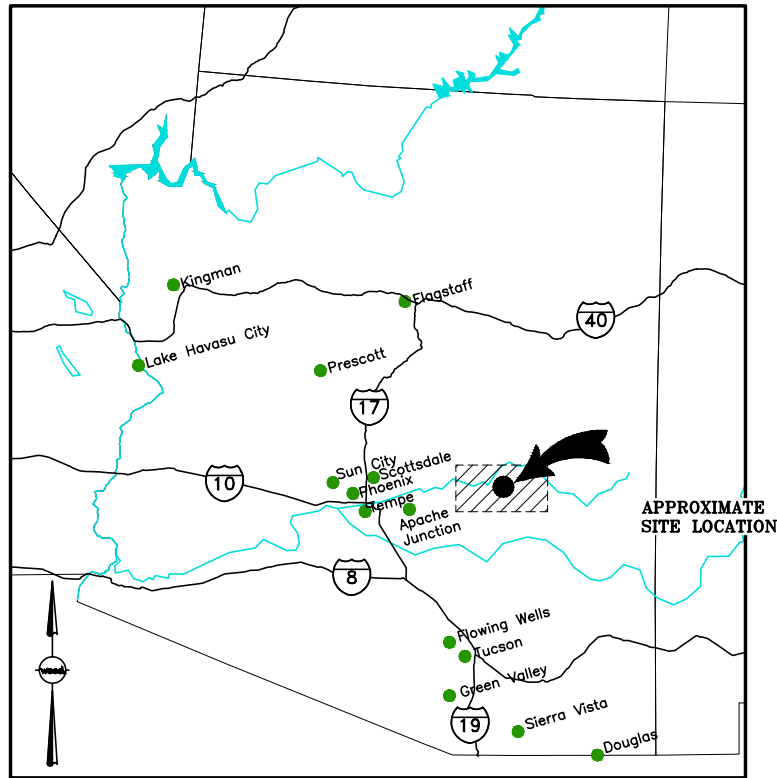

LOCATION MAP

# CONCEPTUAL-LEVEL RECLAMATION DESIGN TAILINGS STORAGE FACILITY NO. 3 PINTO VALLEY MINE, GILA COUNTY, ARIZONA

ISSUED  
DECEMBER 21, 2018

TITLE	DRAWING NO.	FILENAME	REV
COVER AND DRAWING LIST	RE-000	RE-000_TSF3	0
TAILINGS IMPOUNDMENT CLOSURE STORMWATER MANAGEMENT PLAN	RE-001	RE-001_TSF3	0
TAILINGS IMPOUNDMENT CLOSURE PROFILES	RE-002	RE-002_TSF3	0
TAILINGS IMPOUNDMENT CLOSURE DETAILS	RE-003	RE-003_TSF3	0

**PREPARED FOR:**  
Pinto Valley Mining Corporation  
PO Box 100  
Miami, Arizona 85539



# wood.

4600 E. WASHINGTON ST. SUITE 600  
PHOENIX, ARIZONA 85034  
PHONE: 602-733-6000  
FAX: 602-733-6100

G:\Geotechnical\2018 Projects\17-2018-4045 Capstone\_TSF3 Embankment Reconfiguration\CAD\Figures\Impoundment Closure\RE-001\_TSF3.dwg-12/19/2018 1:49 PM

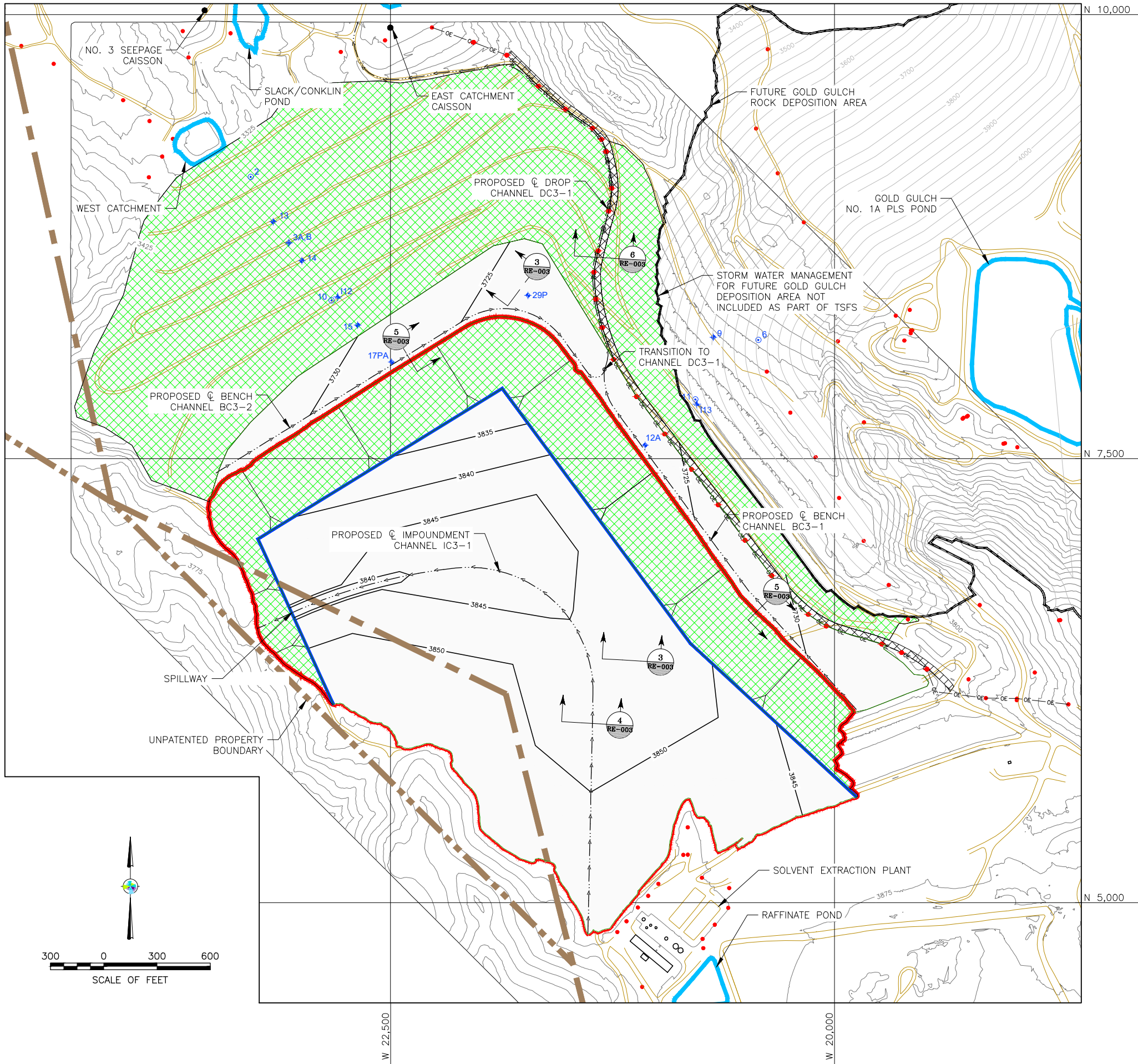

**LEGEND**

- PATENTED PVMC BOUNDARY
- UNPATENTED CLAIMS
- PROPOSED TSF3 BOUNDARY
- EXISTING GROUND SURFACE CONTOUR (25-FT INTERVAL)
- PROPOSED IMPOUNDMENT GRADING SURFACE CONTOUR (5-FT INTERVAL)
- PROPOSED ROCK DEPOSITION GRADING SURFACE CONTOUR (25-FT INTERVAL)
- UNPAVED ROADS
- POWERPOLES
- EXISTING PIEZOMETERS
- APPROXIMATE LIMITS OF MAIN EMBANKMENT FACE TO BE RECLAIMED PER
- PROPOSED DRAINAGE CHANNEL ALIGNMENT
- PROPOSED UTILITY CORRIDOR
- PROPOSED POWERPOLES AND OVERHEAD ELECTRIC

**NOTES**

1. EXISTING TOPOGRAPHY WAS CREATED BY MERGING THE FLYOVER TOPOGRAPHY PROVIDED BY THE MINE IN 2012 UNDER THE FILE NAME "TOPO 2012.dwg" AND THE RECENT AS-BUILT SURVEY OF THE SOUTHWEST BOUNDARY DAM PROVIDED BY THE MINE IN JANUARY 2014 UNDER THE FILE NAME "14001-AS ONLY.DWG". LAYOUTS AND BOUNDARIES OF EXISTING FACILITIES WERE BASED ON THE SITE MAP PROVIDED BY THE MINE IN DECEMBER 2013 UNDER THE FILE NAME "capstone PV site.dwg".
2. REFER TO DRAWING RE-002 FOR PRELIMINARY CLOSURE WATER MANAGEMENT PLAN. REFER TO DRAWING RE-003 FOR TYPICAL DETAILS OF GRADING AND COVER PLACEMENT. REFER TO RE-003 FOR TYPICAL SECTIONS AND DETAILS OF CHANNEL DESIGNS.
3. NON-FUNCTIONAL MONITORING INSTRUMENTS ARE TO BE ABANDONED PER ENGINEER'S RECOMMENDATION.
4. AVERAGE DRAINAGE INVERT GRADES OF ABOUT 0.5% ARE SHOWN WITH THE PROPOSED IMPOUNDMENT SURFACE GRADING PLAN. TAILINGS CONSOLIDATION IS ANTICIPATED TO CONTINUE UNDER POST-CLOSURE CONDITIONS AND MAY RESULT IN ULTIMATE STEEPER OVERALL DRAINAGE GRADES. ALL CHANNEL CUT GRADING IS NOT SHOWN IN THE DRAWING.



CLIENT		PINTO VALLEY MINING CORP.			
PROJECT		TAILINGS STORAGE FACILITY NO. 3 CONCEPTUAL-LEVEL RECLAMATION DESIGN			
TITLE		TAILINGS IMPOUNDMENT CLOSURE STORM WATER MANAGEMENT PLAN			
DESIGNED BY	MH	CHECKED BY	MH	DATE	ISSUED FOR
DRAWN BY	PM	APPROVED BY	TJF	12/21/18	FINAL
FILENAME		FIGURE No.	REV	PROJECT NO.	
RE-001_TSF3		RE-001	A	17-2018-4045	





G:\Geotechnical\2018 Projects\17-2018-4045 Capstone\_TSF3 Embankment\_Reconfiguration\CAD\Figures\Impoundment\_Closure\RE-002\_TSF3.dwg-12/19/2018 10:12 AM

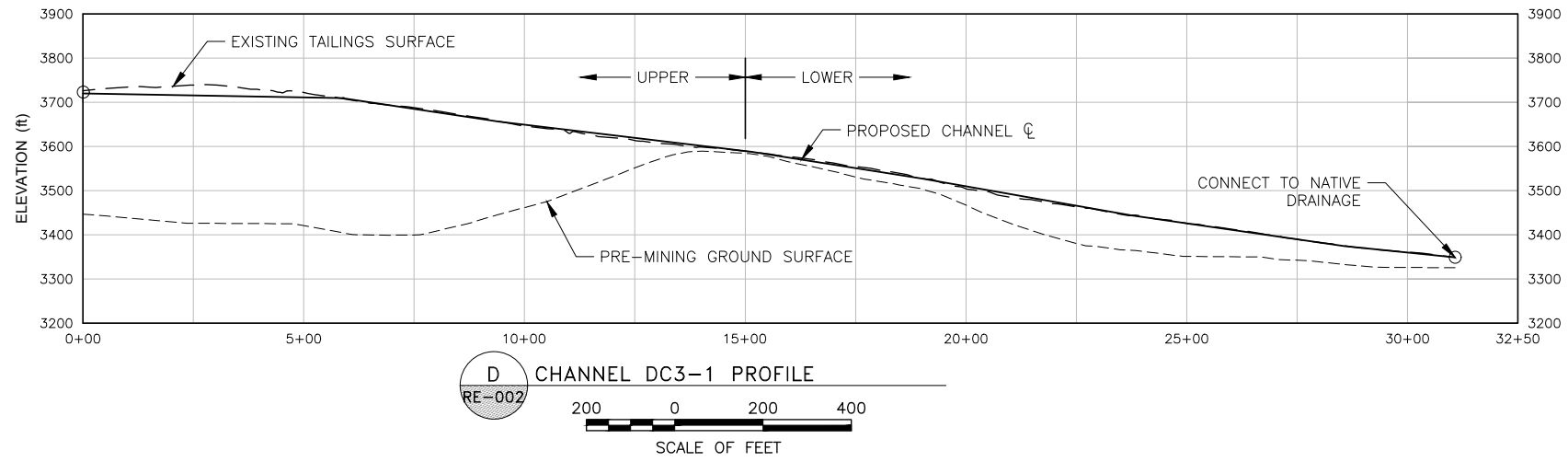
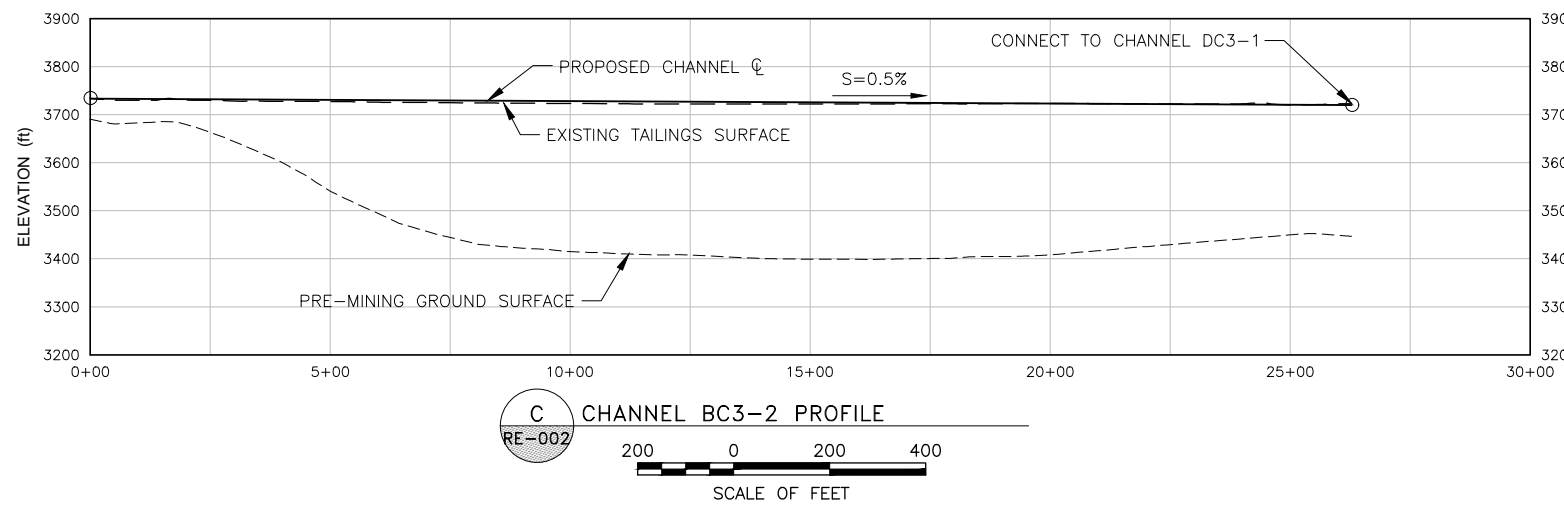
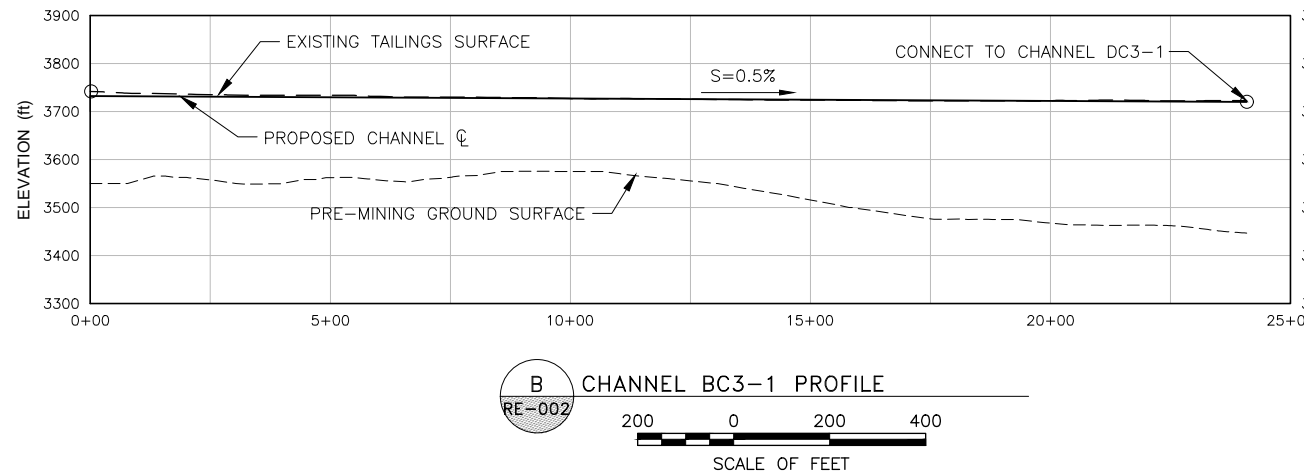
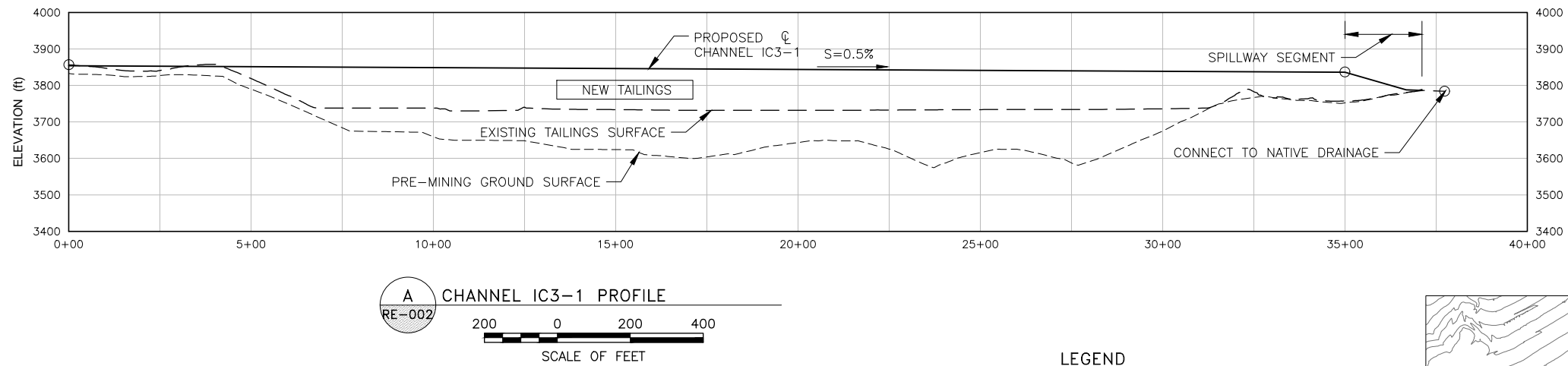

- LEGEND**
- PATENTED PVMC BOUNDARY
  - - - UNPATENTED CLAIMS
  - PROPOSED TSF3 BOUNDARY
  - EXISTING GROUND SURFACE CONTOUR (25-FT INTERVAL)
  - PROPOSED GROUND SURFACE CONTOUR (25-FT INTERVAL)
  - PROPOSED DRAINAGE CHANNEL ALIGNMENT

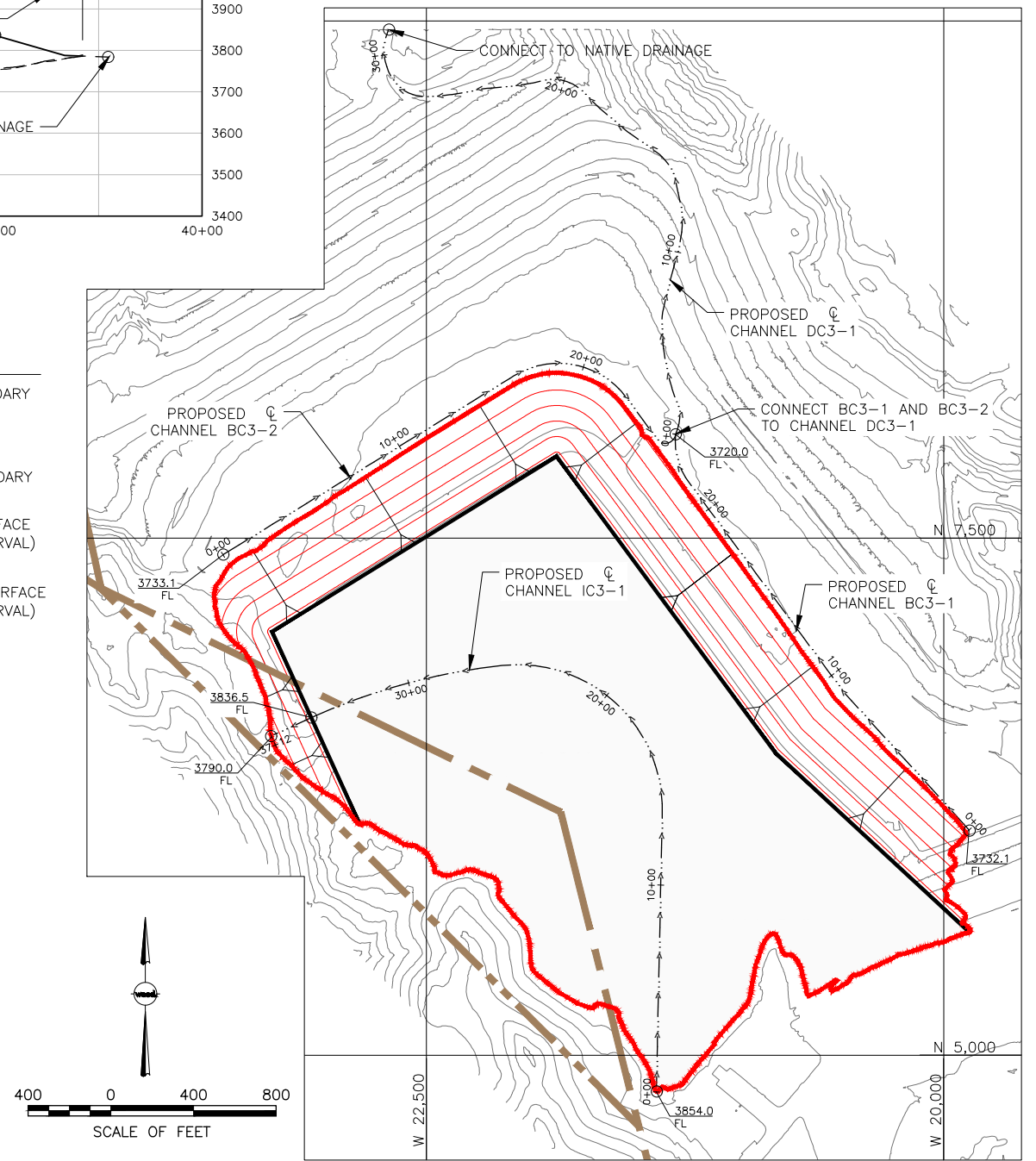

CLIENT PINTO VALLEY MINING CORP.					
PROJECT TAILINGS STORAGE FACILITY NO. 3 CONCEPTUAL-LEVEL RECLAMATION DESIGN					
TITLE TAILINGS IMPOUNDMENT CLOSURE PROFILES					
DESIGNED BY	MH	CHECKED BY	MH	DATE	ISSUED FOR
DRAWN BY	PM	APPROVED BY	TJF	12/21/18	FINAL
FILENAME	RE-002_TSF3	FIGURE No.	RE-002	REV	A
		PROJECT NO.	17-2018-4045		



G:\Geotechnical\2018 Projects\17-2018-4045 Capstone\_TSF3 Embankment Reconfiguration\CAD\Figures\Impoundment Closure\RE-003\_TSF3.dwg-12/19/2018 10:12 AM

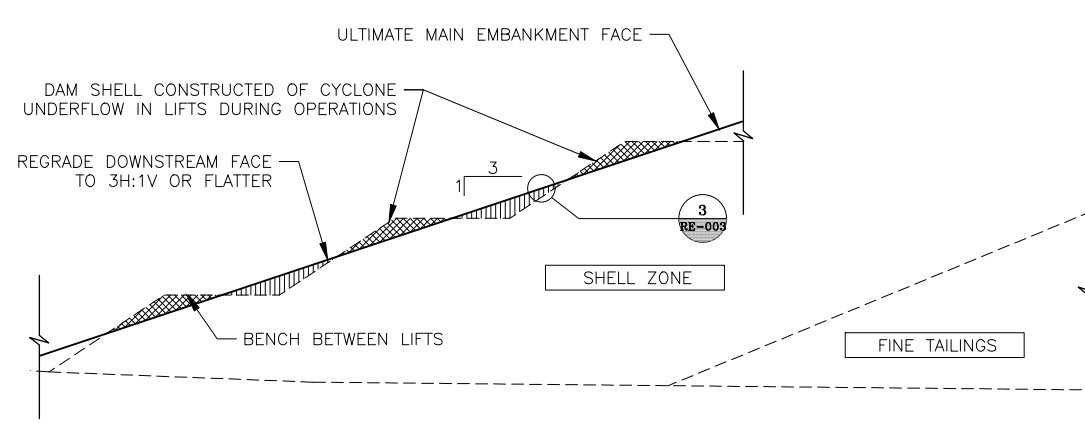

**1** MAIN EMBANKMENT FACE REGRADING  
RE-001 NTS

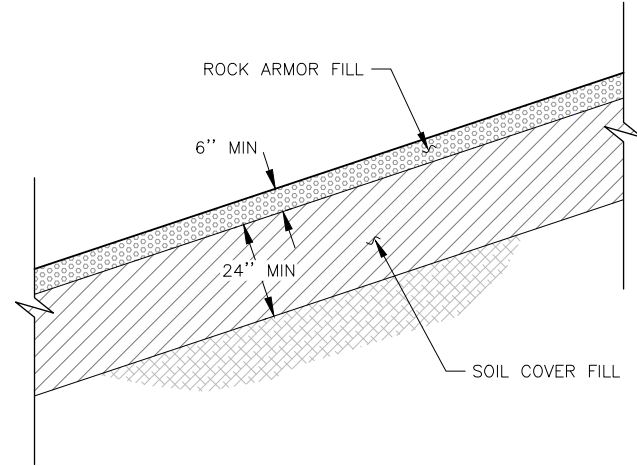

**2** MAIN EMBANKMENT FACE COVER  
RE-001 NTS

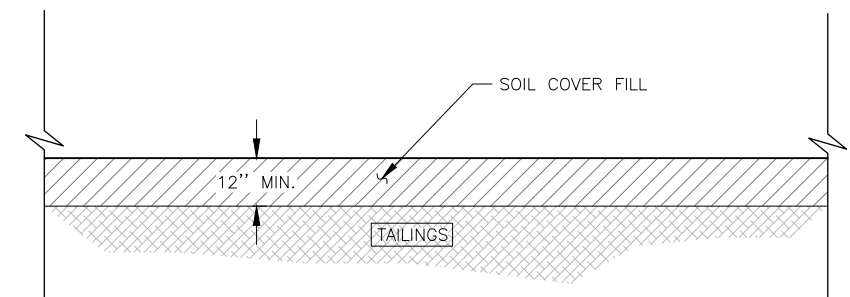

**3** TYP IMPOUNDMENT COVER DETAIL  
RE-001 NTS

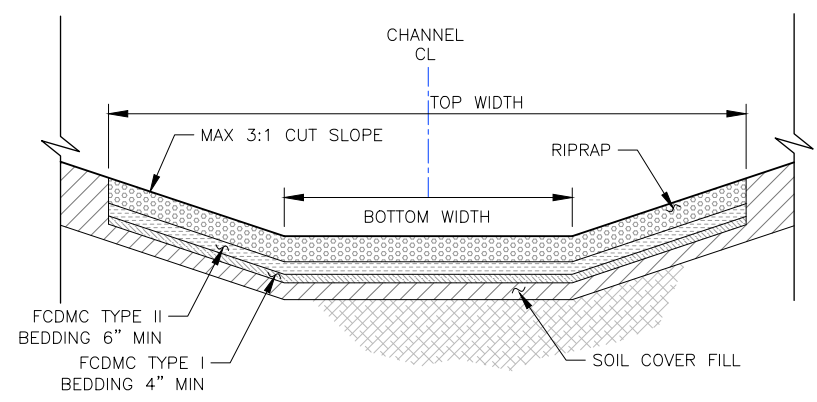

**4** TYP IMPOUNDMENT CHANNEL SECTION  
RE-001 NTS

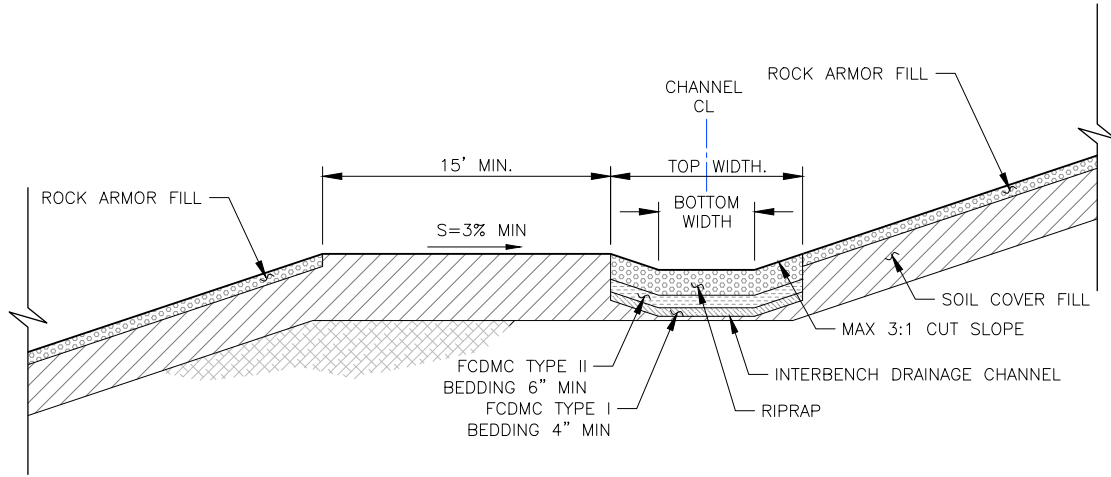

**5** TYP INTERBENCH CHANNEL SECTION  
RE-001 NTS

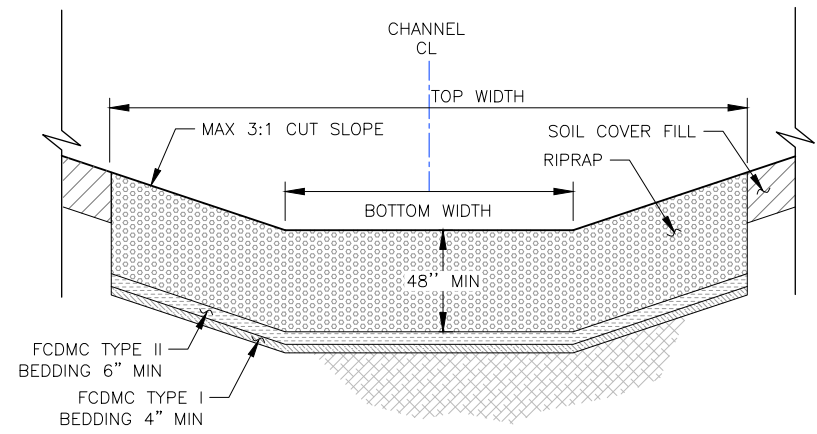

**6** TYP DOWN CHANNEL SECTION  
RE-001 NTS

**LEGEND**

- SUBGRADE OF TAILINGS OR OTHER MINE WASTE
- SOIL COVER FILL
- ROCK ARMOR FILL
- FCDMC TYPE I BEDDING
- FCDMC TYPE II BEDDING
- ZONE OF CUT REGRADING
- ZONE OF FILL REGRADING

TSF3 CHANNEL DIMENSIONS									
CHANNEL	LENGTH (FT)	DESIGN FLOW 100/500 (CFS)	SLOPE (FT/FT)	BOTTOM WIDTH (FT)	TOP WIDTH (FT)	DEPTH (FT)	FLOW DEPTH 100/500 (FT)	VELOCITY 100YR (FPS)	RIPRAP (D <sub>50</sub> ) (IN)
IC3-1	3700	292/374	0.005	30	51	3.5	2.4/2.7	4.6	6
BC3-1	2400	81/104	0.005	10	28	3	2/2.2	3.8	6
BC3-2	2600	104/134	0.005	15	33	3	1.9/2.2	3.8	6
DC3-1 (UPPER)	1500	185/237	0.15	15	33	3	1.4/1.6	14.4	24
DC3-1 (LOWER)	1600	229/293	0.15	20	38	3	1.4/1.6	14.4	24



CLIENT PINTO VALLEY MINING CORP.					
PROJECT TAILINGS STORAGE FACILITY NO. 3 CONCEPTUAL-LEVEL RECLAMATION DESIGN					
TITLE <b>TAILINGS IMPOUNDMENT CLOSURE DETAILS</b>					
DESIGNED BY	MH	CHECKED BY	MH	DATE	ISSUED FOR
DRAWN BY	PM	APPROVED BY	TJF	12/21/18	FINAL
FILENAME RE-003_TSF3		FIGURE No. RE-003	REV A	PROJECT NO. 17-2018-4045	



Mitigation Plan GM-3a  
Post-Closure Tailings Stormwater Control Inspection and Maintenance Plan  
Tailings Storage Facilities No. 3 and No. 4

**Tailings Storage Facility No. 4  
Conceptual Closure Plan**

G:\Geotechnical\2015 Projects\17-2015-4050 Capstone\_TSF4X Tailings Management Feasibility Studies\CAD\Drawings\RE-301-4050M013.dwg-1/11/2017 4:19 PM

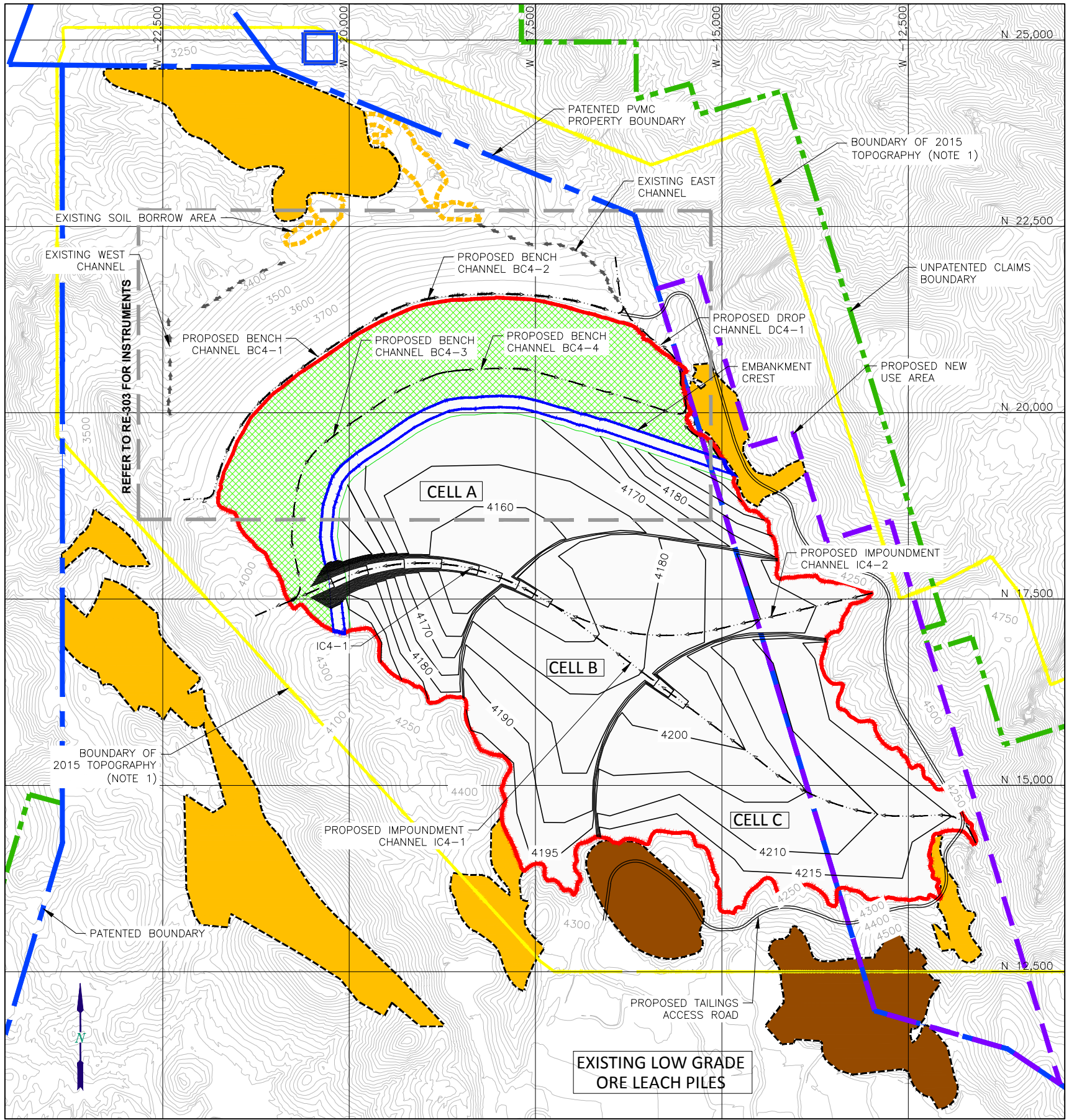

**LEGEND**

- PATENTED PVMC PROPERTY
- UNPATENTED CLAIMS
- PROPOSED NEW USE AREA
- PROPOSED TSF4 EXPANSION BOUNDARY
- EXISTING SOIL BORROW AREA
- PROPOSED ALIGNMENT OF TAILINGS ACCESS ROAD
- EXISTING GROUND SURFACE CONTOUR ELEV, FEET (25-FT INTERVAL)
- PROPOSED IMPOUNDMENT GRADING SURFACE CONTOUR ELEV, FEET (5-FT INTERVAL)
- APPROXIMATE LIMITS OF MAIN EMBANKMENT FACE TO BE RECLAIMED PER
- PROPOSED DRAINAGE CHANNEL ALIGNMENT
- APPROXIMATE LIMITS OF SOIL COVER FILL BORROW AREAS
- APPROXIMATE LIMITS OF BORROW AREAS FOR ROCK ARMOR FILL AND RIPRAP ROCKS

**GENERAL NOTES**

1. EXISTING TOPOGRAPHY NEAR TSF4 WAS CREATED BASED ON A FLYOVER TOPOGRAPHY MAP PROVIDED BY THE MINE IN 2015. EXISTING TOPOGRAPHY OUTSIDE OF THE 2015 TOPOGRAPHY BOUNDARY WAS BASED ON A FLYOVER TOPOGRAPHY MAP PROVIDED BY THE MINE IN 2012.
2. REFER TO DRAWING RE-302 FOR PRELIMINARY CLOSURE WATER MANAGEMENT PLAN. REFER TO DRAWINGS RE-303 AND RE-304 FOR TYPICAL DETAILS AND SECTIONS OF GRADING, COVER PLACEMENT AND CHANNELS. A LAYOUT OF EXISTING AND PROPOSED MONITORING INSTRUMENTS IS ALSO PRESENTED IN DRAWING RE-303.
3. PROPOSED IMPOUNDMENT CHANNEL INVERT GRADES OF 0.5 TO 2.0% ARE SHOWN IN THE PROPOSED GRADING PLAN. ALL CHANNEL CUT GRADING WITH EXCEPTION OF SPILLWAY IS NOT SHOWN IN THIS DRAWING.
4. THE CLOSURE GRADING PLAN SHOWN IS PRELIMINARY AND REFLECTS A STAGED AND ZONED CLOSURE STRATEGY, WHICH CALLS FOR CONSTRUCTING TWO DIVIDER BERMS AND DEVELOPING ULTIMATE IMPOUNDMENT SURFACE IN THREE CELLS, INCLUDING THE NORTH CELL (CELL A), MIDDLE CELL (CELL B) AND SOUTH CELL (CELL C).

**1 TAILING STORAGE FACILITY 4 CLOSURE GRADING**  
 RE-301  
 800 0 800 1600  
 SCALE OF FEET

CLIENT  PINTO VALLEY MINING CORP					
PROJECT TAILINGS STORAGE FACILITY NO. 4 EXTENSION					
TITLE TAILINGS IMPOUNDMENT CLOSURE GRADING PLAN					
DESIGNED BY	PHY	CHECKED BY	PHY	DATE	ISSUED FOR
DRAWN BY	CTS	APPROVED BY	TJF	01/11/17	AGENCY
FILENAME RE-301-4050M013		FIGURE No. RE-301		REV 0	PROJECT NO. 17-2016-4039



## **ATTACHMENT D: COMPREHENSIVE WATER RESOURCE MONITORING AND MITIGATION PLAN**

*The Section 508 amendment of the Rehabilitation Act of 1973 requires that the information in Federal documents be accessible to individuals with disabilities. The Forest Service has made every effort to ensure that the information in the Pinto Valley Mine final EIS is fully accessible. However, certain locations of this attachment (appendix A through appendix C) that was prepared by the proponent is not fully compliant with Section 508. Readers with disabilities are encouraged to contact John Scaggs by phone at (602) 225-5292 or by email at [john.scaggs@usda.gov](mailto:john.scaggs@usda.gov) if they require additional assistance with accessibility of this document.*



# Pinto Valley Mine – Comprehensive Water Resources Monitoring and Mitigation Plan

February 9, 2021



# Table of Contents

- 1 Introduction ..... 1**
  - 1.1 Purpose and Objectives ..... 1
  - 1.2 Background Information ..... 2
- 2 Groundwater Monitoring ..... 3**
  - 2.1 Groundwater Elevation (Manual) and Water Quality Monitoring ..... 3
    - 2.1.1 Compliance Monitoring ..... 3
    - 2.1.2 Supplemental Monitoring ..... 3
  - 2.2 Groundwater Elevation Monitoring (Instrumented) ..... 5
  - 2.3 Flow Monitoring for Selected Production Wells (Instrumented) ..... 6
  - 2.4 Groundwater Monitoring – Carlota Copper Company (Reference Only) ..... 6
- 3 Surface Water and Seep/Spring Monitoring..... 8**
  - 3.1 Supplemental Surface Water Flow Monitoring ..... 8
  - 3.2 Supplemental Surface Water Quality Monitoring ..... 9
  - 3.3 Compliance Surface Water Quality Monitoring ..... 9
  - 3.4 Supplemental Seeps and Springs Flow Monitoring ..... 9
  - 3.5 Compliance Seeps and Springs Water Quality Monitoring ..... 10
- 4 Field Procedures ..... 11**
- 5 Groundwater Model Updates..... 12**
- 6 Reporting and Documentation ..... 13**
  - 6.1 Compliance Reporting ..... 13
  - 6.2 Supplemental Water Resources Reports ..... 13
  - 6.3 Water Resources Adaptive Management ..... 14
- 7 References ..... 17**



## List of Tables

Table 1	Compliance Groundwater Monitoring – Manual Water Level Measurements .....	19
Table 2	Compliance Groundwater Monitoring – Water Quality Measurements .....	21
Table 3	Compliance Monitoring – Instrumented Water Level Measurements .....	22
Table 4	Supplemental Groundwater Monitoring – Manual Water Level Measurements .....	23
Table 5	Supplemental Monitoring – Instrumented Water Level Measurements .....	24
Table 6	Supplemental Groundwater Monitoring – Water Quality Measurements .....	25
Table 7	Supplemental Monitoring – Instrumented Flow Meter Measurements.....	26
Table 8	Carlota Groundwater Monitoring Incorporated by Reference Only into PVM Supplemental Monitoring .....	27
Table 9	Supplemental Surface Water Flow Monitoring .....	28
Table 10	Supplemental Surface Water Quality Monitoring .....	28
Table 11	Supplemental Surface Water Quality Parameters .....	29
Table 12	Compliance Surface Water Monitoring.....	30
Table 13	Supplemental Seeps/Springs Monitoring .....	31
Table 14	Compliance Seeps/Springs Monitoring .....	33
Table 15	Schedule for Compliance Reporting.....	34
Table 16	Schedule for Supplemental Reporting .....	35

## List of Figures

Figure 1	Pinto Valley Mine General Location .....	38
Figure 2	Monitoring Well Network – Existing and Supplemental (North) .....	39
Figure 3	Monitoring Well Network – Existing and Supplemental (South).....	40
Figure 4	Manual Groundwater Monitoring Wells .....	41
Figure 5	Instrumented Monitoring Wells .....	42
Figure 6	Surface Water and Seep/Spring.....	43

## Appendices

Appendix A: Standard Operating Procedures for Monitor Well Installation

Appendix B: Standard Operating Procedures / Quality Assurance Plan for Groundwater Monitoring

Appendix C: Standard Operating Procedures / Quality Assurance Manual for Surface Water and Seep/Spring Sampling

## List of Abbreviations and Acronyms

AAC	Arizona Administrative Code
ADEQ	Arizona Department of Environmental Quality
AL	Alert Level
amsl	above mean sea level
APP	Aquifer Protection Permit
AQL	Aquifer Quality Limit
AWQS	Aquifer Water Quality Standard
AZPDES	Arizona Pollution Discharge Elimination System
BADCT	Best Available Demonstrated Control Technology
bgs	below ground surface
°C	degrees Celsius
EIS	Environmental Impact Statement
EPA	U.S. Environmental Protection Agency
ft	feet
ft bgs	feet below ground surface
gpm	gallons per minute
LoM	life of mine
m	meter
µS/cm	micro Siemens per centimeter
mg/L	milligrams per liter
MSGP	Multi Sector General Permit
N/A or NA	Not Applicable
NEPA	National Environmental Policy Act
NFS	National Forest System
pCi/L	picocuries per liter
PCW	Pinto Creek Watershed
POC	Point of Compliance
PVM	Pinto Valley Mine

## List of Abbreviations and Acronyms (Continued)

PVMC	Pinto Valley Mining Corp.
QA/QC	Quality Assurance/Quality Control
QAP	Quality Management Plan
QMP	Quartz Monzonite Porphyry
SMRF	Self-Monitoring Report Forms
SOP	Standard Operating Procedure
SRK	SRK Consulting (U.S.), Inc.
SWQS	Surface Water Quality Standard
SU	Standard Units
TDS	Total Dissolved Solids
TNF	Tonto National Forest
TSF	tailings storage facility
USGS	U.S. Geological Survey
UTM NAD 83	Universal Transverse Mercator NAD 83
VWP	Vibrating wire piezometer
WL	Water Level
WQ	Water Quality

# 1 Introduction

## 1.1 Purpose and Objectives

The purpose of this comprehensive water resources monitoring and mitigation plan (this Plan) is to organize in one document those actions that Pinto Valley Mining Corp. (PVMC) will do to monitor and track potential changes in groundwater quality and quantity in the shallow alluvial and deeper bedrock aquifers in and around the Pinto Valley Mine (PVM), surface water in Pinto Creek, and selected seeps and springs. The area covered in this Plan includes a 1-mile buffer beyond the projected maximum extent of the modeled 5-foot (ft) change in water levels with respect to the baseline condition, which is 2013 for groundwater (SRK, 2019) and 2018 for seeps/springs. The modeled maximum extent of a 5-ft change in water level following closure is shown in this plan as a dashed boundary in Figure 2 through Figure 6. This boundary considers the relative change in water level 100 years post closure or in approximately 2139.

This Plan addresses planned compliance and supplemental monitoring and reporting activities during the remaining operations, closure, and post-closure periods. Changes and trends to be tracked via monitoring within the 1-mile buffer beyond the modeled 5-ft change in water level contour include:

- Baseflow in Pinto Creek adjacent to and downstream of the Peak wellfield;
- Groundwater levels in a broad area downgradient of tailings storage facilities (TSFs) and the Peak wellfield;
- Elimination of, and/or substantive changes in the flow of seeps and springs;
- Reduction of surface water flow (as measured at a flow monitoring station downstream of the mine and one located as close as feasible upstream of the mine); and
- Groundwater and surface water quality changes associated with seepage from mine facilities as documented within the Aquifer Protection Permit (APP) program as well as an Individual Permit and the Multi-Sector General Permit (MSGP) of the Arizona Pollution Discharge Elimination System (AZPDES) program.

This Plan describes:

- Groundwater Monitoring;
  - Manual and instrumented water level elevations and vertical gradients
  - Water quality
  - Instrumented flow for selected production wells
- Surface Water Monitoring;
  - Flow
  - Water quality
  - Presence of water at seeps/springs
- Field Procedures;
- Groundwater Model Updates; and

- Reporting and Documentation.

## 1.2 Background Information

The sampling, monitoring, and reporting requirements described in this Plan supplement the existing compliance monitoring required by the APP and AZPDES programs. PVMC performs water resources quality compliance monitoring and reporting under the APP for Pinto Valley Mine (APP No. P-100329 (ADEQ, 2019)), an AZPDES Individual Permit No. P-AZ0020401) and Mineral Industry Sectors G and J, of the Arizona MSGP (Permit No. AZMSG2019-02 (MSGP-2019) and future updates). These regulatory programs are administered through Arizona Department of Environmental Quality (ADEQ) and the programs are subject to change as authorized by ADEQ.

The procedures in this Plan provide for the collection of valid and defensible supplemental data that meet data quality requirements of ADEQ. Quality control protocols for sample collection, preservation, and transfer are consistent with those in the 2016 *Quality Management Plan* (ADEQ, 2016).

## 2 Groundwater Monitoring

Groundwater monitoring at PVM includes existing compliance monitoring already being performed as part of the APP program and monitoring of supplemental wells that will continue as part of this Plan. This combined network is designed to meet the goals of monitoring groundwater quality and quantity in both the alluvial and bedrock aquifers in the Plan area. This network includes locations downgradient from TSF3 and TSF4 and adjacent to Pinto Creek. The monitoring locations for supplemental and existing compliance wells are shown in Figure 2 and Figure 3 with blue and red symbols, respectively.

### 2.1 Groundwater Elevation (Manual) and Water Quality Monitoring

#### 2.1.1 Compliance Monitoring

Annually, manual water levels only are measured in 41 monitoring wells as part of the APP compliance monitoring network (Table 1). Daily, water levels are measured via instrumentation at 14 compliance locations as discussed in more detail in Section 2.2.

Quarterly and biennially, water quality samples are collected in 10 APP Point-of-Compliance (POC) and Alert Level (AL) monitoring wells (Table 2). Seven of these 10 wells have manual water level measurements and three have instrumentation to measure water levels (Table 3). The POC and AL wells are screened in bedrock formations.

Compliance groundwater quality monitoring follows Suite A (see Appendix B, Table B1) for quarterly analyses and Suite B (Appendix B, Table B2) for biennial monitoring. Values listed for each analyte represent the minimum detection limit to be communicated to the laboratories to ensure measurements at or below the Aquifer Quality Limit (AQL) for each analyte, as applicable. The AQL is based on the Aquifer Water Quality Standard (AWQS) unless another limit is established based on background conditions. Sulfate and total dissolved solids (TDS) are included in the suites with a minimum detection limit although Arizona does not have an AWQS for TDS or sulfate.

Figure 2 through Figure 5 show the locations of the existing and supplemental groundwater wells to be monitored for groundwater level elevation and/or sampled for water quality. See Section 3 and Appendix B for detailed sample collection procedures.

Note that during the remaining life of mine (LoM) the existing monitoring wells and piezometers may be abandoned or replaced, and/or new monitoring wells and piezometers may be added because of the expansion of the TSFs, waste rock dumps, and Open Pit. The annual report described in Section 6 will provide information about changes that occurred in the well monitoring network during the prior calendar year.

#### 2.1.2 Supplemental Monitoring

For this Plan, supplemental water levels will be monitored in 14 wells. In two of these wells, water levels will be measured manually, as shown in Table 4. For these two wells, water levels will be measured quarterly for the first 2 years and annually for the remainder of the LoM and during the post-closure period. In the other 12 supplemental wells, water levels will be monitored via instrumentation, as shown in Table 5 and discussed in more detail in Section 2.2. These water level

results and trends will be evaluated annually to assess changes in site conditions and effects to groundwater and surface water resources; the monitoring frequency and duration during the post-closure period may be modified depending on the results and trends.

As part of this Plan, PVMC selected two locations that are suitable for installing supplemental well pairs. The locations are as close to the stream channel of Pinto Creek as is feasible, with the objective of monitoring water levels and the vertical gradients between the alluvial and bedrock aquifers in a single location. These two locations are expected to provide thick alluvial formations enhancing the likelihood of monitoring the alluvial aquifer over the long term. The locations were also selected to provide approximately equidistant spacing going downstream (south to north) from an approximate centroid in Pinto Creek west of alluvial aquifer monitoring wells BMW08-6, BMW08-10, and BMW08-10A to the newly drilled well pairs. The existing alluvial aquifer wells were installed in 2008 to monitor for potential tailings seepage. BMW08-10 and BMW08-10A are in two different tributaries to Pinto Creek downstream from TSF4; BMW08-6 is in a tributary to Pinto Creek downstream from TSF3.

The southernmost location for supplemental paired wells is 1.1 miles upstream of U.S. Geological Survey (USGS) stream flow gauge 9498502 (USGS designation “Pinto Creek near Miami” and locally called “Magma Weir”), along the east side of Pinto Creek (Figure 2). The two wells are labelled in Table 5 and Table 6 as “MW-21-01” screened in alluvium and “MW-21-02” screened in bedrock (Gila Conglomerate) indicating they are the first two monitor wells to be drilled in 2021.

The northernmost location for the second set of paired wells is 0.4 miles upstream of the Magma Weir at the edge of the modeled maximum extent of the 5-ft change in water level. These well pairs are labelled as “MW-21-03” screened in alluvium and “MW-21-04” screened in bedrock (Gila Conglomerate). The location was selected based on the presence of a wide braided stream channel sediments with an expected alluvial aquifer. North of this second location, the alluvial sediments are thin to absent, and the aquifers converge to discharge to the surface at Magma Weir.

The four new wells will be installed as soon as practical following the issuance of a Record of Decision in support of the Proposed Action as outlined in the Draft Environmental Impact Statement (EIS). PVMC will finalize the locations to ensure the locations are outside the ordinary high-water mark of “waters of the United States.” Locating the wells above the high-water mark will facilitate vehicle access and reduce the risk of flood damage and vandalism to the wells. A geophysical survey may be performed to confirm the approximate depth of the alluvium prior to drilling. Appendix A provides standard operating procedures recommended by the U.S. Environmental Protection Agency (EPA) for installing groundwater monitoring wells.

Supplemental groundwater quality samples will be collected at seven locations downgradient of TSF3 and TSF4. Three are existing compliance monitoring wells screened in the alluvial aquifer in which water levels are manually measured. Four are the planned well pairs—two screened in the alluvial aquifer and the other two wells in the bedrock aquifer as discussed above. Water quality measurements will be taken in these seven wells quarterly for the first 2 years and biennially for the remainder of the LoM and during the post-closure period. These water quality results and trends will be evaluated annually to assess changes in site conditions and effects to groundwater and surface water resources; the monitoring frequency and duration during the post-closure period may be modified depending on the results and trends.

Supplemental groundwater quality monitoring will follow Suite A (see Appendix B, Table B1) for quarterly analyses and Suite B (Appendix B, Table B2) for biennial monitoring. During the first year,

the extended biennial suite (Appendix B, Table B2) will be analyzed for two of the sampling events to establish baseline values. The analysis methods and minimum detection limits relevant to the methods may change as new laboratory methods and/or analysis instruments are developed. As requested by TNF, PVMC will monitor for TDS and sulfate in the supplemental wells.

## 2.2 Groundwater Elevation Monitoring (Instrumented)

AJAX Ltd. (AJAX) inventoried existing equipment and wellhead configurations for wells within the Peak wellfield and at APP POC wells in 2019 (AJAX, 2019). The instrumented wells are non-production / non-pumping wells within the modeled boundary of the maximum extent of the 5-ft change in the water table reported in the groundwater model (SRK, 2019). Water level measurements in an active pumping well are not representative of the aquifer around the well; therefore, production wells in the Peak wellfield are not included in this water level monitoring program.

In March 2019, AJAX and PVMC installed instrumentation in 11 non-production / non-pumping wells: three APP POC monitoring wells and eight Peak wellfield wells that are not used for pumping water (AJAX, 2019). The instruments are self-contained battery powered pressure transducers and datalogger units. Instrumentation also includes a barometric pressure sensor. During processing, these data remove the effect of barometric pressure.

Data (i.e., water level and temperature) were collected every 15 minutes for 1 year per the approved Work Plan submitted to TNF. The frequency of data collection frequency will be reviewed periodically; the data recording is currently set to measure once daily. More frequent collection intervals may be useful during monsoon season to correlate precipitation data with changes in groundwater elevation, as needed.

Instrument location, installation and equipment details, data collection frequency, and methods for the supplemental monitoring locations with instrumentation are presented in Table 5. Periodic maintenance may necessitate the temporary removal of the instrumentation, and data will not be collected in those wells during those periods of time.

In addition to the transducers, 11 locations are instrumented with Vibrating Wire Piezometers (VWP). The VWPs are collecting data daily and are monitored directly by PVMC. Along with the three APP compliance wells fitted with transducers, water levels in these 11 piezometers are monitored as part of the APP water level compliance program. Instrument location, installation and equipment details, data collection frequency and methods for the compliance monitoring locations with instrumentation are presented in Table 3. Transducer and data logger equipment will be serviced and/or replaced in the future as appropriate to maintain the instrumented monitoring system.

Quarterly, field personnel will download data from the instruments and collect a manual water level measurement, as needed. The manual measurement is used to verify the accuracy of the installed instrumentation. PVMC performs data QA/QC procedures and processes the data to convert it to groundwater elevation.

Figure 5 shows the locations of the wells instrumented with pressure transducers and VWPs included in this Plan.



## 2.3 Flow Monitoring for Selected Production Wells (Instrumented)

Twenty-one production wells are equipped with flow meters connected to a telemetry system. The flow meters are programmed to collect data continuously. Data are transmitted to the PVM control center where they are directly monitored. Data are processed at a minimum on a quarterly basis or more frequently as-needed basis when a maintenance issue is identified. Processing identifies suspect points requiring further analyses and identifies any failing flow meters requiring service and / or replacement. The flow rates are valuable data to assess the effect of pumping drawdown on adjacent wells. These data will be used to update the PVM groundwater model.

Table 7 presents the instrument location, installation and equipment details, data collection frequency, and methods for the wells with flow meters. The flow meters will be maintained and replaced when needed. PVMC staff will retain the manufacturer procedures for meter calibration and maintenance. Figure 5 shows the locations of the wells instrumented with flow meters included in this Plan.

## 2.4 Groundwater Monitoring – Carlota Copper Company (Reference Only)

TNF requested PVMC propose the location for one alluvial well and one bedrock monitoring well to be installed and monitored upstream of the PVM TSFs. The topography of the Pinto Creek streambed and streambed margin upstream of PVM, including the area upstream of TSF3, the reclaimed and/or inactive TSF1 / TSF2, and the inactive Cottonwood Tailings Impoundment, is narrow and rocky with only thin development of patchy alluvium over the bedrock formations. There is no feasible location upstream of PVM for installing a well pair in a single location that would provide meaningful, on-going water level and water chemistry data for both the alluvial and bedrock aquifers.

Independent of groundwater monitoring performed by PVMC, the adjacent mine operated by Carlota Copper Company (Carlota) performs groundwater monitoring pursuant to Section 3.3.4 and in support of Appendix E (Wellfield Mitigation Program) of the *Final Environmental Impact Statement for the Carlota Copper Project* (United States Forest Service, 1997). The Carlota monitoring locations in Pinto Creek are upstream of TSF3 and TSF4. The wellfield monitoring currently includes quarterly field parameters and quarterly water quality sampling (Table 8). Carlota reports the results of their groundwater quality and groundwater level monitoring to TNF in an annual report. For many years, these data have been used to characterize the alluvial and bedrock aquifers in Pinto Creek adjacent to the Carlota Mine, which is due south of PVMC's TSF3. These existing monitoring data are also adequate to characterize the aquifers upstream of PVMC's active TSFs based on the proximity of these wells to the TSFs. These wells are outside of the modeled change in groundwater elevations that may occur as a result of PVMC operations 100 years after mine closure, but within the 1-mile buffer of that modeled extent.

The Carlota groundwater monitoring program includes five alluvial aquifer monitoring wells (AMW-16P, AMW-19, AMW-22, AMW-23, and AMW-23B) that are in the centerline or margin of Pinto Creek and are upstream, and/or downstream of Carlota's water supply wells (BMW-32 and TW-2). These five alluvial monitoring wells are also upstream of TSF3 and TSF4 as shown in Figure 3, Figure 4, and Figure 5. Two of these alluvial aquifer monitoring wells in Pinto Creek (AMW-22

and AMW-23) have long-term water level measurements dating to the 1990s, which could provide additional value for establishing aquifer conditions upstream of PVMC's TSFs.

The Carlota groundwater program also includes three bedrock aquifer monitoring wells (BMW-31, BMW-33, and TW-3) that are in the centerline or margin of Pinto Creek (Table 8). BMW-31 and TW-3 are below the confluence with Haunted Canyon and are downstream of the two Carlota water supply wells. BMW-33 is located upstream of the confluence with Haunted Canyon and upstream of Carlota's water supply wells. The three wells are all upstream of TSF3 and TSF4.

Data from Carlota's groundwater monitoring in the Pinto Creek streambed and streambed margin will be collected by Carlota and reported in their annual report. These data are sufficient to characterize the aquifers upstream of TSF3 and TSF4. Alluvial aquifer monitoring wells AMW-23 and AMW-23B and bedrock aquifer monitoring well TW-3 are the farthest downstream from the influence of Carlota's water supply wells and provide the most meaningful "well pair" data set on the groundwater aquifer conditions upstream of PVM TSFs.

PVMC will reference the water level data from the five alluvial and three bedrock monitoring wells as provided to TNF in Carlota's annual reports. The Carlota water level data will be included in the PVM potentiometric surface map provided to TNF in PVMC's *Comprehensive Supplemental Water Resources Monitoring Report* described in Section 6.2. PVMC will reference Carlota's annual report commentary about the aquifer conditions in well set AMW-23, AMW-23B, and BMW-31, and augment with additional interpretation relative to PVM aquifer conditions, as needed.

# 3 Surface Water and Seep/Spring Monitoring

Under this Plan, surface water monitoring at PVM will include a network of U.S. Geological Survey (USGS) stream flow gauges, mine site outfalls, and seep/spring monitoring locations located on and around the mine site. Thirteen outfalls are currently monitored as part of the AZPDES Individual Permit and MSGP programs. Also, six seeps and springs are currently monitored and sampled as part of the APP and Individual Permit AZPDES programs. These programs are subject to change under authorization by ADEQ.

This Plan would add additional monitoring of flow and water quality in Pinto Creek via monitoring at the USGS stream flow gauges and additional observations at 25 seeps/springs.

## 3.1 Supplemental Surface Water Flow Monitoring

This Plan assumes that the three stream gauge stations immediately adjacent to and downstream of PVM will continue to be monitored and maintained by the USGS under a technical assistance agreement with PVMC and/or other parties. These USGS stations are in the only practical and feasible locations for surface water (stream flow) monitoring due to the nature of the wide, braided streambed geometry elsewhere along Pinto Creek.

Physical monitoring of the stream flows and reasonable maintenance of the gauging stations (as agreed upon in advance with PVMC) will be conducted by USGS with financial support provided under agreement with PVMC and/or other parties as arranged by USGS. Annually, PVMC will plot and interpret the publicly available data collected in the field by the USGS from the USGS datalogger systems for the prior year. The analysis will include the local precipitation data and stream flow rates (cubic ft per second) noting record completeness / quality and discussing the trends seen in the data relative to prior years. The three USGS stream gauge stations located in Pinto Creek going from upstream to downstream reaches near PVM are:

- 94985005 “Pinto Creek Above Haunted Canyon” located upstream of the confluence of Haunted Canyon,
- 9498501 “Pinto Creek Below Haunted Canyon” located 1.2 miles downstream of 94985005 below the confluence with Haunted Canyon, and
- 9498502 “Pinto Creek near Miami, AZ” located 5.32 miles downstream of 9498501, north-northwest of PVM, locally called “Magma Weir.”

Details about the stations are provided in Table 9. Surface water flow measurements for the publicly available data for the three stream gauge stations will be downloaded from the USGS website (<https://waterdata.usgs.gov/nwis> or similar website as updated by USGS) and evaluated for trends and changes relative to the prior years. Figure 6 shows the surface water flow monitoring locations.

## 3.2 Supplemental Surface Water Quality Monitoring

Supplemental seasonal surface water quality samples will be taken at one station representing water quality upstream of PVM TSFs (9498501 Below Haunted Canyon) and at one station representing water quality downstream of PVM TSFs (9498502, Magma Weir) as listed Table 10.

USGS flow gauge station 9498501 below the confluence with Haunted Canyon is located dominantly upstream of the active tailings facilities at PVM (i.e. west of TSF3 and south of TSF4). Magma Weir is downstream of the PVM site and tailings facilities.

Seasonal monitoring will consist of collecting one water quality sample at the two stream flow gauge stations (9498501 and 9498502) during each of two wet seasons consistent with the 2019 MSGP, which defines the summer wet season as June 1 to October 31 and the winter wet season as November 1 to May 31. When collecting a sample from Pinto Creek at the USGS stream flow stations, the sample shall only be collected if water is flowing at a rate sufficient to ensure a representative sample can be taken. A sample should not be collected from a low point where stagnant water has accumulated. This fluid may not be representative due to evaporation or addition of chemical constituents from overland wash or runoff, or wildlife.

The constituents including general chemistry, major cation/anions, trace metals/metalloids, and field parameters are listed in Table 11. Sampling during the two wet seasons will continue annually through the remaining LoM and during the post-closure period, subject to annual review and recommendation of modifications to the constituents, frequency, and/or duration of sampling, as is deemed relevant by an evaluation of the results and trends.

## 3.3 Compliance Surface Water Quality Monitoring

Surface water quality samples are currently collected from 13 locations as part of the AZPDES Individual Permit and MSGP compliance programs. Table 12 shows compliance surface water monitoring locations specified in the AZPDES Individual Permit and MSGP programs. AZPDES permit number AZ0020401 authorizes discharge stormwater mixed with mine process water and mine drainage at outfalls PV-002, PV-003, and PV-004. Outfall PV-005, is a continuously flowing industrial discharge. AZ0020401 authorizes continuous discharges from PV-005. PVMC is authorized to discharge stormwater under AZPDES General Permit for Stormwater Discharges associated with Industrial Activity – Mineral Industry Sectors G and J, Permit No. AZMSG2019-02 (MSGP-2019 and future updates). Figure 6 shows the surface water quality monitoring locations.

## 3.4 Supplemental Seeps and Springs Flow Monitoring

The presence of water at 25 previously documented seeps and springs will be evaluated as part of this Plan; flow measurements will be collected where feasible. These springs are believed to have water present on a persistent basis based on single baseline measurements taken by AJAX in June 2018. The seeps and springs are natural features with a wide variation in flow and geomorphology. Actual flow will not be measured for flows less than 1 gpm that create only moist or damp soil conditions; the technician will record flow of “< 1 gpm” on the field sheet for these conditions. The technician will use a calibrated bucket and timer to measure sustained flows greater than 1 gpm when site conditions are feasible; otherwise, an approximate flow estimate will be noted on the field sheet. Table 13 presents the supplemental seeps and springs monitoring points [see detailed

background descriptions in AJAX (2018)]. Figure 6 shows the seeps and springs monitoring locations.

### **3.5 Compliance Seeps and Springs Water Quality Monitoring**

Compliance seeps and springs water quality samples are currently collected from six locations. When collecting a sample at a seep or spring, the sample shall only be collected if water is flowing at a flow rate of at least 1 gallon per minute (gpm). A sample should not be collected from a low point where water from the seep or spring has accumulated. This fluid may not be representative due to evaporation or addition of chemical constituents from overland wash or runoff, or wildlife.

See Section 4 *Field Procedures* and Appendix C for detailed sample collection procedures. Table 14 presents the compliance seeps and springs monitoring locations. Figure 6 shows the compliance surface water quality monitoring locations.

## 4 Field Procedures

The standard operating procedures (SOPs) and quality assurance plans (QAPs) for the field tasks are provided in:

- Appendix A: Standard Operating Procedures for Monitor Well Installation;
- Appendix B: Standard Operating Procedures / Quality Assurance Plan for Groundwater Monitoring; and
- Appendix C: Standard Operating Procedures / Quality Assurance Manual for Surface Water and Seep/Spring Sampling.

Appendix A is SOP number 2048, *Monitoring Well Installation*, by Scientific Engineering Response and Analytical Services (SERAS), prepared under contract to the EPA (SERAS, 2001). *Monitoring Well Installation* explains the most common drilling methods; sample preservation, containers, handling, and storage procedures for collecting during well drilling; field equipment and preparation; well construction; well development; relevant calculations; documentation procedures; and health and safety.

Appendix B is PVMC's QAP (PVMC, 2019) for APP compliance monitoring. It includes instructions on data quality objectives; staff roles and responsibilities; laboratory reporting limits; laboratory and field quality control; laboratory data quality assessment and validation; documentation protocols; sample collection, holding, transporting, and shipping; data management, including field data, analytical data, data storage, data quality assurance / quality control (QA/QC); and program audits. The PVM APP QAP meets the requirements of the APP compliance monitoring program administered by ADEQ.

Appendix C is PVMC's Quality Assurance Manual (QAM) (PVMC, 2019) for the AZPDES compliance monitoring program. This QAM includes water quality field parameter measurements with details on objectives, equipment, instrumentation, preparation, procedures, decontamination, waste disposal, documentation, and quality assurance. PVM will use the QA/QC procedures contained within the AZPDES QAM for surface water sample collection. The PVM AZPDES QAM meets the requirements of the AZPDES compliance monitoring program administered by ADEQ.

Updates to these SOPs will be inserted in this Plan from time to time.

# 5 Groundwater Model Updates

The results of a numerical groundwater flow model completed in May 2019 for the Pinto Creek Watershed were provided to TNF in the report Pinto Valley Mine – Groundwater Modeling for Mine Extension (Revised) (SRK, 2019). The PVM MODFLOW-SURFACT numerical groundwater flow model will be maintained on a long-term basis during operations and the post-closure periods to support the on-going assessment of water level trends, the response by the alluvial and bedrock aquifers to water production pumping, changing tailings water fluxes, and the potential post-closure impacts from tailings seepage.

The first update will incorporate data through the end of December 2020 with a report to be completed by May 31, 2021. Subsequent reports will be completed by the end of May every other year through May 31, 2027. The 2-year frequency for updating the model with data from new and existing monitoring points through the end of the previous relevant period is appropriate to refine and re-calibrate the 2019 model.

Between mid-2027 through 2039, minimal changes in average daily, monthly, and/or annual tailings water fluxes are expected to occur. Five-year groundwater model updates will be provided on or before May 31, 2032 and May 31, 2037. This will ensure that an updated groundwater model is available for closure planning purposes. Model reviews and updates will continue on a 5-year basis through the post-closure period. If there is an extended period of non-production or care and maintenance, the dates for the model updates will be adjusted forward.

The numerical flow groundwater model will be validated and recalibrated, as needed, based on:

- Drawdown data from well hydrographs during operations;
- Vertical gradient measurements in the alluvial and bedrock aquifers from paired wells,
- Well recovery data during the latter years of operations (in response to a reduction of flow rates) and during the post-closure period;
- Baseflow estimates from the analysis of streamflow at Magma Weir and the regional / mine-specific precipitation records;
- Flows from seeps/springs (note: the latter is a soft target for model recalibration); and
- The addition of new drilling, as relevant, that may alter the prior distribution of hydrogeological units in the model requiring model construction revisions.

# 6 Reporting and Documentation

## 6.1 Compliance Reporting

PVMC will provide TNF with copies of compliance monitoring reports as described below and listed in Table 15. PVMC will provide TNF with the data collected during the calendar year for supplemental locations monitored as part of this Plan as described in Section 6.2.

1. Annually, PVMC submits an APP groundwater report summarizing water quality results and trends for the prior calendar year. The appendices to this report include:
  - a. Laboratory Reports;
  - b. A potentiometric surface map and cross sections documenting the water level elevations and demonstrating an inward hydraulic gradient exists around the Open Pit;
  - c. A report on the Best Available Demonstrated Control Technology (BADCT) site inspections performed by PVMC; and
  - d. A report by PVMC's tailings engineer of record on the phreatic surface within the TSFs and TSF stability.
2. Quarterly, PVMC submits APP self-monitoring report forms (SMRFs) with water quality results for Point-of-Compliance and Alert Level Monitoring Points.
3. Annually, PVMC submits an AZPDES compliance report providing stormwater and surface water flows and quality data for PVM outfalls discharging to Pinto Creek for the prior calendar year. This report also provides appendices with:
  - a. Laboratory Reports; and
  - b. A report on the AZPDES inspections performed by PVMC.

## 6.2 Supplemental Water Resources Reports

PVMC will prepare supplemental reports for TNF as follows on the schedule listed in Table 15:

1. Quarterly instrumentation reports describing the status of the instrumented wells, equipment for monitoring water levels in the wells, and plots of the water levels for the period of record. *Note: This report will continue quarterly until the EIS is finalized (expected in April 2021) and will revert to an annual report thereafter.*
2. An annual seep and spring survey report describing the status of the seeps and springs monitored in June of each year as part of this Plan.
3. An annual *Comprehensive Supplemental Water Resources Monitoring Report* for the supplemental monitoring sites described in this Plan including:
  - Description of dates, times, and methods for all supplemental monitoring activities;
  - Compilation of laboratory analyses plus laboratory reports (PDF and Excel) and data validation reports;



- Hydrographs and analysis of trends in groundwater levels, surface water flows, seep/spring flows, and water quality for the supplemental monitoring sites described in this Plan;
  - Comparison of changes observed during the previous year and to the baseline data collected in 2018 or other relevant year(s);
  - Figures showing the supplemental monitoring locations, groundwater level contours for the alluvial and bedrock aquifers, surface water flows, and the seep/spring flows described in this Plan in relation to the 5-ft projected change in phreatic surface boundary;
  - Relevant text and tables referencing the water quality and water level data collected by Carlota upstream of PVM's TSFs that are reported to TNF for the monitoring of aquifer conditions downstream of the Carlota Mine in Carlota's annual report to TNF. The Carlota alluvial monitoring wells to be included in PVMC's annual water level contour map for the alluvial aquifer are: AMW-16P, AMW-19, AMW-22, AMW-23, and AMW-23B. The Carlota bedrock monitoring wells to be included in PVMC's annual water level contour map for the bedrock aquifer are BMW-31, BMW-33, and TW-3.  
  
Relevant text referencing the interaction of water levels and water quality reported by Carlota in their annual report for well set AMW-23, AMW-23B, and TW-3 with additional discussion by PVMC, as needed, to provide context for the conditions upstream of TSF3 and TSF4.
  - Based on the interpretation of the sampling and monitoring results, identification and description of potential impacts to groundwater or surface water resources relative to the prior year and to the baseline data, which is 2013 for groundwater and surface water flow in Pinto Creek and 2018 for seeps and springs. Note: The annual comprehensive report will include Item 1 (annual instrumentation report) and Item 2 (annual seep and spring survey report) as technical appendices and/or these reports will be integrated into the comprehensive report itself;
  - Development of criteria that would be used to identify impacts to baseflow in perennial stream reaches or springs that are directly and reasonably attributable to the mine; and
  - Development of site-specific mitigation plans, as necessary and feasible, to address reductions in baseflow or drying up of streams or springs directly and reasonably attributable to the mine.
4. A biennial (5-year in post-closure period) groundwater model report summarizing updates to the model including:
- Data added to model, including updates to pumping and calibration targets
  - Changes, if any, to the geologic model
  - Validation of previous version of the model or recalibration, as necessary
  - Results of validation or changes to parameters and results of recalibration
  - Explanation of significant changes to projected water levels or drawdown levels from previous model projections.

### 6.3 Water Resources Adaptive Management

Water quality thresholds and management practices established in the APP by ADEQ for APP-designated discharging facilities are designed to minimize impacts to groundwater. Contingency Plan

requirements for action and adaptive management are established in Section 2.6 of PVM's APP. The APP establishes actions to be taken in the event of exceeding an Alert Level or an AQL measured in groundwater, seeps, and springs downgradient of the TSFs and for overtopping of the TSF and discharge of unauthorized materials to the environment. This Contingency Plan is in effect for operations, temporary care and maintenance, and closure/post-closure periods and is subject to amendment should substantive changes be made in the future to the operation of the TSFs.

The surface water quality sampling results for analytes measured in samples from the Pinto Creek flow gauging stations will be compared to the reference surface water quality standards (SWQS) for the designated uses specified in Arizona Administrative Code (AAC) R18-11. The designated uses for the reach of Pinto Creek downstream from an unnamed tributary at 33°19'27"/110°54'56", which includes the reach of Pinto Creek that flows past the Carlota and PVM mine sites, are: Aquatic and Wildlife (warm water), Full-Body Contact, Fish Consumption, Agricultural Irrigation, and Agricultural Livestock Watering. The aquatic and wildlife (warm water) site-specific copper standard for Pinto Creek is 0.034 mg/L for hardness values below 268 mg/L (see Appendix C of AAC R18-11).

Supplemental surface water quality data will be collected quarterly or seasonally per specific monitoring program for a 2-year baseline period. Following this 2-year period, PVMC will assess the results with respect to the reference SWQSs relevant to this reach of Pinto Creek for surface water samples.

Sample or monitoring results will be referenced to the prior year and to the baseline period (i.e., 2013 for groundwater and surface water flow in Pinto Creek and 2018 for seeps/springs). Sample results for newly installed wells or other sample points will reference back to when the monitoring was established in 2021. Sample collection will be annually or biennially during the remaining LoM per specific monitoring program. Sampling will continue annually for the post-closure period, or until trend analysis indicates modifications are justified and warranted to the monitoring activities (groundwater levels/quality, surface water flow/quality, seeps/spring) in terms of constituents, frequency of monitoring, and/or duration of monitoring. As part of the annual report, PVMC will provide suggested modifications, if any, to the monitoring of the supplemental sites described in the annual report. PVMC will implement modifications to this Plan, as authorized by the TNF, as soon as reasonably practicable.

Trigger thresholds for managing water quality in the supplemental wells will be based on reference Arizona AWQSs or other relevant site-specific standard after a review of the 2-year baseline data. Trigger thresholds for managing supplemental surface water will be based on the Pinto Creek SWQSs. Setting a trigger threshold for supplemental seeps/springs is not planned. Only one flow measurement data point per spring exists currently and may not represent the range of results that could occur over time including responses by seeps, springs, and surface water flow to climate change and the challenges to ensure a good quality sample for samples taken in contact with local soils, animal feces, or other interactions that would potentially contaminate the sample.

As part of the annual report, PVMC will provide suggested modifications, if any, to the monitoring of the supplemental sites described in the annual report. Potential suggestions include adding or removing monitoring sites and adding or removing parameters being monitored based on results for that year. PVMC will implement authorized modifications to this Plan as soon as reasonably practicable.

Possible investigations and activities to mitigate impacts related to drawdown in the remaining LoM may include performing well scans or other downhole surveys to document the as-built well construction for the water production wells and ensure best practices are in place as related to well construction. Wells showing substantive defects in well construction may be evaluated for abandonment, repair, or replacement. PVM will annually review sources of alternative water supply to offset pumping in the Peak wellfield, PVM will annually review the effectiveness of the wellfield pumping configuration and may adjust the duration or frequency of pumping from specific wells to effect changes in hydraulic gradient control. As part of the adaptive management strategy, PVMC will develop site specific mitigation plans, as necessary and feasible, to address reductions in baseflow or drying up of perennial stream reaches or springs that are directly and reasonably attributable to the mine operations.

# 7 References

- Arizona Department of Environmental Quality (ADEQ), 2016, Quality management plan: guidance document, June 2016, 64 p., accessible at [http://static.azdeq.gov/ust/ust\\_quality\\_assurance\\_plan.pdf](http://static.azdeq.gov/ust/ust_quality_assurance_plan.pdf)
- Arizona Department of Environmental Quality (ADEQ), 2019, Aquifer Protection Permit No. P-100329, Place ID 838, LTF 78425: permit issued to Pinto Valley Mining Corp., September 20, 2019, 65 p.
- Arizona Department of Environmental Quality (ADEQ), 2019, Arizona Pollutant Discharge Elimination System: permit number AZ0020401: Quality Assurance Manual: appendix A: Standard Operating Procedures, July 30, 2019, 45 p.
- AJAX, 2018, Seep, Spring and Well Inventory in the Pinto Creek Watershed: unpublished technical memorandum prepared for PVMC., July 30, 2019, 118 p., 2 appendices.
- AJAX, 2019, Well Instrumentation Work Plan: unpublished technical memorandum prepared for PVMC., February 6, 2019, 10 p., 1 appendix.
- Pinto Valley Mining Corp. (PVMC), 2019, Arizona Aquifer Protection Permit: Quality Assurance Plan, July 2019, 22 p., 3 appendices.
- Scientific Engineering and Response and Analytical Services, 2001, Standard operating procedures: monitor well installation, SOP #2048, Revision 0.0, 07/12/2001, U.S. Environmental Protection Agency, Contract EP-W-09-031, 16 p., 1 appendix.
- SRK Consulting, 2019, Pinto Valley Mine – Groundwater modeling for mine extension (Revised): unpublished report prepared for PVMC., May 3, 2019, 181 p., 2 appendices.
- United States Forest Service, 1997, Final Environmental Impact Statement for Carlota Copper Project – Tonto National Forest, July 1997, 7 appendices.
-

## Tables

**Table 1 Compliance Groundwater Monitoring – Manual Water Level Measurements**

Hole ID	Monitoring Activity	ADWR Well Registry No.	TD (ft)	UTM NAD 83		Measuring Point Elevation (ft)	Screen Interval	Screened Formation	Monitoring Frequency	Description
				Easting (m)	Northing (m)					
BMW08-1	WL	Unknown	6	502,621	3,693,854	3,709	3-6	Alluvium	Annual	APP WL
BMW08-6	WL	Unknown	18	499,864	3,698,537	3,164	8-18	Alluvium	Annual	APP WL
BMW08-7	WL	Unknown	49	501,253	3,697,690	3,417	17-32	Alluvium	Annual	APP WL
BMW08-10	WL	Unknown	8	500,110	3,702,450	2,992	3-8	Alluvium	Annual	APP WL
BMW08-10A	WL	Unknown	7	500,121	3,702,376	2,993	2-7	Alluvium	Annual	APP WL
CDX-03	WL	n/a	1110	504,989	3,696,271	4,540	Unknown	QMP	Annual	APP WL
Cowboy 10	WL	n/a	460	504,996	3,696,023	4,538	Unknown	QMP	Annual	APP WL
DH08-11	WL	Unknown	300	501,971	3,695,935	3,908	280-300	Gila Conglomerate	Annual	APP WL
DH08-12	WL	Unknown	299	502,491	3,695,658	3,909	270-290	Gila Conglomerate	Annual	APP WL
DH08-31	WL	Unknown	301	503,158	3,695,644	4,139	280-300	Pinal Schist	Annual	APP WL
Domestic 2	WL	n/a	465	502,469	3,694,238	3,845	Unknown	Unknown	Annual	APP WL
GTI-MW-3	WL	55-525044	81	502,675	3,695,134	3,879	19-79	Gila Conglomerate	Annual	APP WL
GTI-MW-4	WL	55-525043	81	502,647	3,694,784	3,886	19-79	Gila Conglomerate	Annual	APP WL
GTI-MW-5	WL	55-526381	100	502,936	3,695,138	3,947	50-100	Gila Conglomerate	Annual	APP WL
Miller Springs 1	WL	n/a	1150	502,505	3,695,003	3,809	Unknown	Gila Conglomerate	Annual	APP WL
MW-04-01	WL	55-900563	103	502,711	3,693,847	3,740	40-100	Manitou Granite	Annual	APP WL
MW-04-02	WL	55-900604	100	503,464	3,694,311	4,027	50-100	Tailings	Annual	APP WL
MW-04-03	WL	55-900605	90	502,014	3,694,917	3,582	40-90	Gila Conglomerate	Annual	APP WL
MW-04-04	WL	55-900606	153	501,238	3,695,411	3,484	100-150	Naco Limestone	Annual	APP WL
MW-04-06	WL	55-900635	100	502,238	3,696,100	3,883	70-100	Naco Limestone	Annual	APP WL
MW-04-07	WL	55-900723	340	501,857	3,696,712	4,004	280.5-320.5	Limestone	Annual	APP WL
MW-04-09	WL	55-900631	400	501,310	3,697,677	3,442	30-60	Whitetail Conglomerate/Diabase	Annual	APP WL
MW-04-10	WL	55-900632	497	501,858	3,698,379	4,131	290-340	Dacite	Annual	APP WL
MW-04-12	WL	55-900633	320	500,786	3,701,811	3,347	290-320	Dacite	Annual	APP WL
MW-04-13	WL	Unknown	514	502,006	3,697,365	4,034.8	484-514	Leach Dump (Phreatic WL)	Annual	APP WL
MW-16-100	WL	55-919760	333	503,068	3,699,439	3,996	283-333	Diabase	Annual	APP WL
MW-16-200	WL	55-919761	690	503,707	3,698,664	4,689	600-690	QMP & Diabase	Annual	APP WL
PZ-08-6A	WL	Unknown	1250	501,796	3,697,011	4,038	Unknown	Mixed Lithologies	Annual	APP WL
PZ-14-20	WL	55-917524	1002.1	503,806	3,697,690	4,399	Unknown	QMP and/or Diabase	Annual	APP WL

**Table 1 Compliance Groundwater Monitoring – Manual Water Level Measurements (Continued)**

Hole ID	Monitoring Activity	ADWR Well Registry No.	TD (ft)	UTM NAD 83		Measuring Point Elevation (ft)	Screen Interval (ft bgs)	Screened Formation	Monitoring Frequency	Description
				Easting (m)	Northing (m)					
Shopsite 1	WL	55-640814	150	502,929	3,694,997	3,886	Unknown	Gila Conglomerate/Basalt	Annual	APP WL
Shopsite 2	WL	55-612354	1510	503,052	3,694,906	4,023	Unknown	Gila Conglomerate/Basalt	Annual	APP WL
S08-7	WL	Unknown	515	502,047	3,697,583	4,034.37	504-509	Leach Dump (Phreatic WL)	Annual	APP WL
S08-9	WL	Unknown	230	502,709	3,697,996	4,248.93	415-420	Leach Dump (Phreatic WL)	Annual	APP WL
South 38	WL	55-908110	530	503,030	3,695,617	4,093	Multiple	Pinal Schist	Annual	APP WL
South 8	WL	55-545983	600	503,091	3,695,612	4,102	Unknown	Pinal Schist	Annual	APP WL
Southeast 1B	WL	55-545985	200	503,524	3,696,419	4,023	Unknown	Unknown	Annual	APP WL
TSF3-9	WL	Unknown	200.2	500,337	3,698,465	3,227	30-110	Dacite	Annual	APP WL
TSF3-13	WL	Unknown	99	501,033	3,697,757	3,536	45-85	Unknown	Annual	APP WL
U-8-4	WL	Unknown	124	502,055	3,701,637	3,816.13	74-124	Tailings (Phreatic WL)	Annual	APP WL
West 32	WL	Unknown	690	502,514	3,695,895	3,986	Unknown	Mixed Lithologies	Annual	APP WL
West 33	WL	Unknown	800	502,318	3,696,459	3,825	340-460, 560-760	Mixed Lithologies	Annual	APP WL

Notes:  
 TD = total depth  
 ft = feet  
 m = meter  
 bgs = below ground surface  
 WL = Water Level  
 UTM NAD 83 = Universal Transverse Mercator North American Datum 1983  
 During the remaining LoM, the existing wells in 2020 are subject to abandonment and replacement and/or new wells may be built as the mine facilities (i.e., Open Pit, tailings, waste rock dumps) expand

**Table 2 Compliance Groundwater Monitoring – Water Quality Measurements**

Hole ID	Monitoring Activity	ADWR Well Registry No.	TD (ft)	UTM NAD 83		Measuring Point Elevation (ft)	Screen Interval (ft bgs)	Screened Formation	Monitoring Frequency	Description	WL Measuring Method
				Easting (m)	Northing (m)						
APP-1A	WQ/WL	55-543407	200	501,864	3,701,984	3,592	90-190	Gila Conglomerate	Quarterly, Biennial per APP	APP-WQ/WL	Instrumented
APP-1Br	WQ/WL	55-543408	460	501,866	3,701,990	3,590	370-450	Dripping Spring Quartzite	Quarterly, Biennial per APP	APP-WQ/WL	Instrumented
APP-2	WQ/WL	55-543406	250	500,279	3,701,734	3,172	140-240	Dacite	Quarterly, Biennial per APP	APP-WQ/WL	Instrumented
APP-3A	WQ/WL	55-543404	48	499,880	3,698,540	3,169	23.6-43.6	Dacite	Quarterly, Biennial per APP	APP-WQ/WL	Manual
APP-3B	WQ/WL	55-543405	250	499,867	3,698,546	3,166	145-245	Dacite	Quarterly, Biennial per APP	APP-WQ/WL	Manual
APP-4	WQ/WL	55-543403	153	499,862	3,698,101	3,256	45-145	Dacite	Quarterly, Biennial per APP	APP-WQ/WL	Manual
APP-5A	WQ/WL	55-543402	35	501,351	3,695,090	3,468	25-35	Diabase	Quarterly, Biennial per APP	APP-WQ/WL	Manual
APP-5B	WQ/WL	55-545846	200	501,353	3,695,090	3,472	92-192	Diabase	Quarterly, Biennial per APP	APP-WQ/WL	Manual
APP-6	WQ/WL	55-543401	135	501,609	3,694,855	3,516	24-114	Pinal Schist	Quarterly, Biennial per APP	APP-WQ/WL	Manual
APP-7	WQ/WL	55-560644	124	500,527	3,699,228	3,443	58-118	Gila Conglomerate	Quarterly, Biennial per APP	APP-WQ/WL	Manual

Notes:  
 TD = total depth  
 ft = feet  
 m = meter  
 bgs = below ground surface  
 WQ = Water Quality  
 WL = Water Level  
 UTM NAD 83 = Universal Transverse Mercator North American Datum 1983  
 During the remaining LoM, the existing wells in 2020 are subject to abandonment and replacement and/or new wells may be built as the mine facilities (i.e., Open Pit, tailings, waste rock dumps) expand.



**Table 3 Compliance Monitoring – Instrumented Water Level Measurements**

Hole ID	Well Type	ADWR Well Registry No.	TD (ft)	UTM NAD 83		Measuring Point Elevation (ft amsl)	Equipment Depth Below Measuring Point (ft)	Equipment Elevation (ft)	Equipment	Equipment Description	Data Collection Method	Data Recording Frequency	Screened Formation	Program
				Easting (m)	Northing (m)									
APP-1A	NPW	55-543407	200	501,866	3,701,995	3,589	Not Known	Not Known	Pressure transducer	Van Essen: TD-Diver	Manual Download	Daily	Gila Conglomerate	APP
APP-1Br	NPW	55-563251	485	501,866	3,701,990	3,591	461.4	3,130	Pressure transducer	Van Essen: TD-Diver	Manual Download	Daily	Dripping Spring Quartzite	APP
APP-2	NPW	55-543406	250	500,280	3,701,735	3,172	223.27	2,949	Pressure transducer	Van Essen: TD-Diver	Manual Download	Daily	Dacite	APP
PZ-08-02	NPW		1,301	502,986	3,695,633	4,101	125	3,976	Pressure transducer	GEOKON 4500 Vibrating Wire Piezometer	Manual Download	Daily	Pinal Shcist	APP
PZ-08-04	NPW		1,210	502,361	3,696,415	3,840	303	3,537	Pressure transducer	GEOKON 4500 Vibrating Wire Piezometer	Manual Download	Daily	Whitetail Conglomerate	APP
PZ-08-05	NPW		1,100	502,211	3,696,758	3,786	152	3,634	Pressure transducer	GEOKON 4500 Vibrating Wire Piezometer	Manual Download	Daily	Waste Rock	APP
PZ-08-08	NPW		1,517	502,843	3,697,724	4,192	800	3,392	Pressure transducer	GEOKON 4500 Vibrating Wire Piezometer	Manual Download	Daily	QMP	APP
PZ-08-13	NPW	55-910478	1,520	501,670	3,696,639	3,879	444	3,435	Pressure transducer	GEOKON 4500 Vibrating Wire Piezometer	Manual Download	Daily	Whitetail Conglomerate	APP
PZ-08-14	NPW		1,520	501,944	3,695,956	3,906	202	3,704	Pressure transducer	GEOKON 4500 Vibrating Wire Piezometer	Manual Download	Daily	Basalt	APP
PZ-08-15	NPW		1,500	502,483	3,695,677	3,909	237	3,672	Pressure transducer	GEOKON 4500 Vibrating Wire Piezometer	Manual Download	Daily	Basalt	APP
PZ-14-17	NPW		383	502,683	3,695,913	3,817	299	3,518	Pressure transducer	GEOKON 4500 Vibrating Wire Piezometer	Manual Download	Daily	Diabase	APP
PZ-14-18	NPW		926	502,534	3,696,060	3,820	558	3,262	Pressure transducer	GEOKON 4500 Vibrating Wire Piezometer	Manual Download	Daily	Diabase / Whitetail Conglomerate	APP
PZ-14-19	NPW		1,002	502,991	3,697,414	4,212	756	3,456	Pressure transducer	GEOKON 4500 Vibrating Wire Piezometer	Manual Download	Daily	Ruin Granite	APP
DW08-2	NPW		1,338	502,295	3,696,992	3869.791	447	3,423	Pressure transducer	GEOKON 4500 Vibrating Wire Piezometer	Manual Download	Daily	Diabase	APP

Notes: N/A = Not applicable; PW= Production Well; NPW = Non-Production Well  
 UTM NAD 83 = Universal Transverse Mercator North American Datum 1983

During the remaining LoM, the wells and piezometers existing in 2020 are subject to abandonment and replacement and/or new wells or piezometers may be built as the mine facilities (i.e., Open Pit, tailings, waste rock dumps) expand.

**Table 4 Supplemental Groundwater Monitoring – Manual Water Level Measurements**

Hole ID	Monitoring Activity	ADWR Well Registry No.	TD (ft)	UTM NAD 83		Measuring Point Elevation (ft)	Screen Interval (ft bgs)	Screened Formation	Monitoring Frequency	Description
				Easting (m)	Northing (m)					
GTI-MW-1	WL	55-525041	199	503,049	3,694,828	3,942	39-199	Gila Conglomerate	Quarterly for baseline, Annually after two years	Supplemental WL
GTI-MW-6	WL	55-526380	90	502,809	3,694,630	3,896	40-90	Gila Conglomerate	Quarterly for baseline, Annually after two years	Supplemental WL

Notes:

TD = total depth

ft = feet

m = meter

bgs = below ground surface

WL = Water Level

UTM NAD 83 = Universal Transverse Mercator North American Datum 1983

During the remaining LoM, the existing wells in 2020 are subject to abandonment and replacement and/or new wells may be built as the mine facilities (i.e., Open Pit, tailings, waste rock dumps) expand.

**Table 5 Supplemental Monitoring – Instrumented Water Level Measurements**

Hole ID	Well Type	ADWR Well Registry No.	TD (ft)	UTM NAD 83		Measuring Point Elevation (ft amsl)	Equipment Depth Below Measuring Point (ft)	Equipment Elevation (ft)	Equipment	Equipment Description	Data Collection Method	Data Recording Frequency	Screened Formation	Program
				Easting (m)	Northing (m)									
Peak Well 03	NPW		805	499,659	3,704,388	2,981	98.99	2,882	Pressure transducer	Van Essen: TD-Diver	Manual Download	Daily	Gila Conglomerate	Supplemental
Peak Well 08	NPW	55-612361	1,255	500,455	3,703,815	3,007	164.21	2,843	Pressure transducer	Van Essen: TD-Diver	Manual Download	Daily	Gila Conglomerate	Supplemental
Peak Well 11	NPW	55-612359	825	499,106	3,706,310	3,189	493.04	2,696	Pressure transducer	Van Essen: TD-Diver	Manual Download	Daily	Gila Conglomerate	Supplemental
Peak Well 12	NPW		905	499,106	3,702,947	3,097	197.56	2,899	Pressure transducer	Van Essen: TD-Diver	Manual Download	Daily	Bedrock (Unknown)	Supplemental
Peak Well 16	NPW		800	499,711	3,703,717	2,960	131.27	2,829	Pressure transducer	Van Essen: TD-Diver	Manual Download	Daily	Gila Conglomerate	Supplemental
Peak Well 18	NPW	55-640809	703	497,726	3,705,905	3,635	705.21	2,930	Pressure transducer	Van Essen: TD-Diver	Manual Download	Daily	Quartzite	Supplemental
Peak Well 24	NPW		845	499,384	3,701,961	2,969	35.57	2,933	Pressure transducer	Van Essen: TD-Diver	Manual Download	Daily	Dacite	Supplemental
Peak Well 30	NPW	55-612299	700	496,969	3,703,437	3,138	130.01	3,008	Pressure transducer	Van Essen: TD-Diver	Manual Download	Daily	Gila Conglomerate	Supplemental
MW-21-01 <sup>1</sup>	NPW	TBD	TBD	500,020 <sup>2</sup>	3,703,705 <sup>2</sup>	TBD	TBD	TBD	Pressure transducer	TBD	Manual Download	Daily	Alluvium	Supplemental
MW-21-02 <sup>1</sup>	NPW	TBD	TBD	500,010 <sup>2</sup>	3,703,700 <sup>2</sup>	TBD	TBD	TBD	Pressure transducer	TBD	Manual Download	Daily	Gila Conglomerate	Supplemental
MW-21-03 <sup>1</sup>	NPW	TBD	TBD	500,169 <sup>2</sup>	3,704,721 <sup>2</sup>	TBD	TBD	TBD	Pressure transducer	TBD	Manual Download	Daily	Alluvium	Supplemental
MW-21-04 <sup>1</sup>	NPW	TBD	TBD	500,162 <sup>2</sup>	3,704,722 <sup>2</sup>	TBD	TBD	TBD	Pressure transducer	TBD	Manual Download	Daily	Bedrock (TBD)	Supplemental

Notes:  
 ft = feet  
 m = meter  
 amsl = above mean sea level  
 NPW = Non-Production Well  
 TBD = To Be Determined

<sup>1</sup>YR-NN = 2-digit year in which the monitoring well is constructed and the well order (for example, MW-21-01 for the first monitoring well that is constructed in 2021)

<sup>2</sup> Coordinates are approximate, exact location to be determined prior to drilling the wells

UTM NAD 83 = Universal Transverse Mercator North American Datum 1983

During the remaining LoM, the existing wells in 2020 are subject to abandonment and replacement and/or new wells may be built as the mine facilities (i.e., Open Pit, tailings, waste rock dumps) expand.

**Table 6 Supplemental Groundwater Monitoring – Water Quality Measurements**

Hole ID	Monitoring Activity	ADWR Well Registry No.	TD (ft)	UTM NAD 83		Measuring Point Elevation (ft)	Screen Interval (ft bgs)	Screen Formation	Monitoring Frequency	Description
				Easting (m)	Northing (m)					
BMW08-6	WQ	Unknown	18	499,864	3,698,537	3,164	8-18	Alluvium	Quarterly, Biennial	Supplemental-WQ
BMW08-10	WQ	Unknown	8	500,110	3,702,450	2,992	3-8	Alluvium	Quarterly, Biennial	Supplemental-WQ
BMW08-10A	WQ	Unknown	7	500,121	3,702,376	2,993	2-7	Alluvium	Quarterly, Biennial	Supplemental-WQ
MW-21-01 <sup>1</sup>	WQ	TBD	150 <sup>3</sup>	500,020 <sup>2</sup>	3,703,705	TBD	40-150 <sup>3</sup>	Alluvium	Quarterly, Biennial	Supplemental-WQ
MW-21-02	WQ	TBD	250 <sup>3</sup>	500,015 <sup>2</sup>	3,703,700	TBD	200-250 <sup>3</sup>	Bedrock	Quarterly, Biennial	Supplemental-WQ
MW-21-03	WQ	TBD	80 <sup>3</sup>	500,170 <sup>2</sup>	3,704,720	TBD	40-80 <sup>3</sup>	Alluvium	Quarterly, Biennial	Supplemental-WQ
MW-21-04	WQ	TBD	180 <sup>3</sup>	500,160 <sup>2</sup>	3,704,720	TBD	130-180 <sup>3</sup>	Bedrock	Quarterly, Biennial	Supplemental-WQ

Notes:

TD = total depth

ft = feet

m = meter

bgs = below ground surface

WQ = Water Quality

TBD = To Be Determined

<sup>1</sup>YR-NN = 2-digit year in which the monitor well is constructed and the well order (for example, MW-21-01 for the first monitoring well that is constructed in 2021)

<sup>2</sup> Coordinates are approximate, exact location to be determined prior to drilling the wells

<sup>3</sup> Total depths and screen interval depths will be finalized based on field conditions (i.e. actual contact depth of formations and regional water levels).

UTM NAD 83 = Universal Transverse Mercator North American Datum 1983

During the remaining LoM, the existing wells in 2020 are subject to abandonment and replacement and/or new wells may be built as the mine facilities (i.e., Open Pit, tailings, waste rock dumps) expand.

**Table 7 Supplemental Monitoring – Instrumented Flow Meter Measurements**

Hole ID	Well Type	ADWR Well Registry No.	TD (ft)	UTM NAD 83		Measuring Point Elevation (ft amsl)	Equipment	Equipment Description	Data Collection Method	Data Recording Frequency	Screened Formation	Program
				Easting (m)	Northing (m)							
Peak Well 02	PW	55-612309	749	499,851	3,705,006	2,954	Flow meter	Seametrics: Paddlewheel	Telemetry-Radiofrequency	Continuous	Gila Conglomerate/Quartzite	Supplemental
Peak Well 04	PW	55-612308	512	500,699	3,702,830	3,088	Flow meter	Seametrics: Paddlewheel	Telemetry-Radiofrequency	Continuous	Gila Conglomerate/Dacite	Supplemental
Peak Well 06	PW	55-612307	1,105	498,897	3,703,797	3,115	Flow meter	Seametrics: Paddlewheel	Telemetry-Radiofrequency	Continuous	Gila Conglomerate/Quartzite	Supplemental
Peak Well 07	PW	55-612306	656	501,172	3,702,696	3,210	Flow meter	Seametrics: Paddlewheel	Telemetry-Radiofrequency	Continuous	Gila Conglomerate	Supplemental
Peak Well 14	PW	55-612305	703	497,759	3,705,201	3,332	Flow meter	Seametrics: Paddlewheel	Telemetry-Radiofrequency	Continuous	Gila Conglomerate	Supplemental
Peak Well 15	PW	55-612304	640	499,530	3,703,046	2,996	Flow meter	Seametrics: Paddlewheel	Telemetry-Radiofrequency	Continuous	Gila Conglomerate/Dacite	Supplemental
Peak Well 17	PW	55-612303	804	499,503	3,702,400	2,998	Flow meter	Seametrics: Paddlewheel	Telemetry-Radiofrequency	Continuous	Unknown	Supplemental
Peak Well 21	PW	55-612302	784	496,890	3,705,764	3,632	Flow meter	Seametrics: Paddlewheel	Telemetry-Radiofrequency	Continuous	Gila Conglomerate/Quartzite	Supplemental
Peak Well 23	PW	55-805553	765	500,487	3,702,349	3,190	Flow meter	Seametrics: Paddlewheel	Telemetry-Radiofrequency	Continuous	Dacite/Quartzite	Supplemental
Peak Well 26	PW	55-612301	550	499,371	3,698,264	3,180	Flow meter	Seametrics: Paddlewheel	Telemetry-Radiofrequency	Continuous	Unknown (Limestone or Diabase)	Supplemental
Peak Well 37	PW	55-500797	775	501,139	3,695,426	3,475	Flow meter	Seametrics: Paddlewheel	Telemetry-Radiofrequency	Continuous	Limestone	Supplemental
Peak Well 46B	PW	55-224349	1,055	500,462	3,702,079	3,300	Flow meter	Seametrics: Paddlewheel	Telemetry-Radiofrequency	Continuous	Dacite	Supplemental
Peak Well 48	PW	55-525060	1,200	500,507	3,702,077	3,285	Flow meter	Seametrics: Paddlewheel	Telemetry-Radiofrequency	Continuous	Dacite	Supplemental
Peak Well 49	PW	55-528179	620	500,409	3,702,890	3,025	Flow meter	Seametrics: Paddlewheel	Telemetry-Radiofrequency	Continuous	Dacite	Supplemental
Peak Well 50	PW	55-528180	620	500,610	3,702,879	3,080	Flow meter	Seametrics: Paddlewheel	Telemetry-Radiofrequency	Continuous	Dacite	Supplemental
Peak Well 51	PW	55-528181	820	500,238	3,702,657	3,090	Flow meter	Seametrics: Paddlewheel	Telemetry-Radiofrequency	Continuous	Dacite	Supplemental
Peak Well 52	PW	55-528182	740	500,353	3,702,143	3,270	Flow meter	Seametrics: Paddlewheel	Telemetry-Radiofrequency	Continuous	Dacite	Supplemental
Peak Well 53	PW	55-528861	840	500,442	3,702,594	3,280	Flow meter	Seametrics: Paddlewheel	Telemetry-Radiofrequency	Continuous	Dacite	Supplemental
Peak Well 80	PW	55-917903	1,130	500,529	3,702,959	3,134	Flow meter	Seametrics: Paddlewheel	Telemetry-Radiofrequency	Continuous	Dacite	Supplemental
Peak Well 81	PW	55-228115	980	500,999	3,702,505	3,389	Flow meter	Seametrics: Paddlewheel	Telemetry-Radiofrequency	Continuous	Dacite/Quartzite	Supplemental
Peak Well 82	PW	55-921831	1,000	500,911	3,702,286	3,347	Flow meter	Seametrics: Paddlewheel	Telemetry-Radiofrequency	Continuous	Dacite	Supplemental

Notes: ft = feet; m = meter; amsl = above mean sea level; N/A = Not applicable; PW= Production Well  
 UTM NAD 83 = Universal Transverse Mercator North American Datum 1983

**Table 8** Carlota Groundwater Monitoring Incorporated by Reference Only into PVM Supplemental Monitoring

Hole ID	UTM NAD 83		Data Collection and Frequency			Remarks/Rationale
	Easting (m)	Northing (m)	Field Parameter Measurements	Water Quality Sampling	Groundwater Level Measurements	
Groundwater Program - Alluvial Wells						
AMW-16P	499,304	3,696,987	-	-	Hourly	On center line of Pinto Creek, downgradient of Wellfield; monitor Wellfield operations
AMW-19	499,614	3,696,494	Quarterly	Quarterly	Hourly	On margin of Pinto Creek, upgradient of Wellfield
AMW-22	499,355	3,696,833	Quarterly	Quarterly	Hourly	On margin of Pinto Creek, adjacent to TW-2
AMW-23	499,045	3,697,449	Quarterly	Quarterly	Hourly	On margin of Pinto Creek, paired with AMW-23B, downgradient of Wellfield
AMW-23B	499,071	3,697,449	-	-	Hourly	On center line of Pinto Creek, paired with AMW-23, downgradient of Wellfield
Groundwater Program - Bedrock Wells						
BMW-31	499,149	3,697,049	-	-	Hourly	Downgradient of Wellfield--Monitor water levels to evaluate impact of Wellfield pumping.
BMW-33*	499,639	3,697,048	-	-	Hourly	Upgradient of Wellfield--Monitor water levels to evaluate impact of Wellfield pumping.
TW-1	499,304	3,696,340	-	-	Hourly	Upgradient of Wellfield--Monitor water levels to evaluate impact of Wellfield pumping.
TW-3	498,994	3,697,449	-	-	Hourly	Downgradient of Wellfield--Monitor water levels to evaluate impact of Wellfield pumping.

Notes: \* = Estimated Location – Not Surveyed

UTM NAD 83 = Universal Transverse Mercator North American Datum 1983

Source: Extracted from Table 1 Monitoring Plan Requirements, 2019 Annual Wellfield Area – Groundwater and Surface Water Monitoring prepared for Carlota Copper Company by Clear Creek Associates and submitted to TNF. Monitoring of these points is performed by Carlota and reported annually to TNF.

**Table 9 Supplemental Surface Water Flow Monitoring**

Site ID	Coordinates UTM NAD 83		Program	Description	Monitoring Frequency
	Easting (m)	Northing (m)			
USGS 094985005 Pinto Creek Above Haunted Canyon	500,129	3,696,279	Supplemental	USGS Stream Flow Gauge	Compile USGS data, Annually
USGS 09498501 Pinto Creek Below Haunted Canyon	499,111	3,697,702	Supplemental	USGS Stream Flow Gauge	Compile USGS data, Annually
USGS 09498502 Pinto Creek Near Miami, AZ (locally called Magma Weir)r	500,428	3,705,370	Supplemental	USGS Stream Flow Gauge	Compile USGS data, Annually

Notes:  
 UTM NAD 83 = Universal Transverse Mercator North American Datum1983  
 m = meter  
 USGS = United States Geological Survey

**Table 10 Supplemental Surface Water Quality Monitoring**

Site ID	Coordinates UTM NAD 83		Program	Description	Monitoring Frequency
	Easting (m)	Northing (m)			
USGS 09498501	499,111	3,697,702	Supplemental	WQ	Once per wet season
USGS 09498502 Magma Weir	500,428	3,705,370	Supplemental	WQ	Once per wet season

Notes:  
 UTM NAD 83 = Universal Transverse Mercator North American Datum1983  
 USGS = United States Geological Survey  
 Carlota Copper Company performs quarterly surface water quality sampling at USGS 09498501 stream flow gauge station downstream of the confluence of Haunted Canyon with Pinto Creek (Carlota Sample Site PC-7) and reports the results annually to TNF.

**Table 11 Supplemental Surface Water Quality Parameters**

Parameter mg/L unless otherwise noted	Sample Form
<b>General Chemistry, Major Cations/Anions</b>	
Alkalinity	
Calcium	D
Magnesium	D
Nitrate+Nitrite (as N)	
Sulfate	
Total Dissolved Solids	
Total Suspended Solids	
Hardness (CaCO <sub>3</sub> ) (Calculated)	
<b>Trace Metals and Metalloids</b>	
Arsenic	T & D
Copper	T & D
Iron	T & D
Manganese	T & D
Selenium	T & D
Zinc	T & D
<b>Field Parameters</b>	
pH (su)	
Conductivity (umhos/cm)	
Water Temperature (F)	
Turbidity	
Dissolved Oxygen	

Notes: Sample forms, method, methods may be updated over time to reflect current laboratory practice.  
D = Dissolved Metals (filtered)  
T = Total Metals



**Table 12 Compliance Surface Water Monitoring**

Site ID	Coordinates UTM NAD 83		Program	Description	Monitoring Frequency
	Easting (m)	Northing (m)			
PV002	501,421.9	3,694,677.2	AZPDES-Individual	Water Quality	1x/Daily/Discharge
PV003	500,259.3	3,698,095.6	AZPDES-Individual	Water Quality	1x/ Daily/Discharge
PV004	502,791.3	3,693,846.0	AZPDES-Individual	Water Quality	1x/Daily/Discharge
PV005	504,057.5	3,693,292.2	AZPDES-Individual	Water Quality	Quarterly, annually as required.
SW-WB3	501,138.3	3,695,416.3	MSGP	Water Quality, Visual Assessment	Once per wet season
SW-NB1	500,586.5	3,702,016.7	MSGP	Water Quality, Visual Assessment	Once per wet season
SW-NB2	500,317.0	3,701,647.5	MSGP	Water Quality, Visual Assessment	Once per wet season
SW-NB3	501,153.3	3,702,310.6	MSGP	Water Quality, Visual Assessment	Once per wet season
SW-NB8	501,059.3	3,702,703.7	MSGP	Water Quality, Visual Assessment	Once per wet season
SW-NB9	500,878.7	3,702,427.1	MSGP	Water Quality, Visual Assessment	Once per wet season
SW-NB10	500,930.3	3,702,172.1	MSGP	Water Quality, Visual Assessment	Once per wet season
SW-LCC1	502,584.8	3,693,815.2	MSGP	Water Quality, Visual Assessment	Once per wet season
SW-CS1	504,140.1	3,693,322.9	MSGP	Water Quality, Visual Assessment	Once per wet season

Notes:

m = meter

AZPDES = Arizona Pollutant Discharge Elimination System

MSGP = Multi-Sector General Permit, periodically updated by ADEQ as needed

UTM NAD 83 = Universal Transverse Mercator North American Datum 1983

**Table 13 Supplemental Seeps/Springs Monitoring**

Site ID	Coordinates UTM NAD 83		Feature	Program	Description	Monitoring Frequency
	Easting (m)	Northing (m)				
Bootlegger Spring	496,573	3,701,033	Spring	Supplemental	Water Flow	Annually
Brushy Spring	494,420	3,706,582	Spring	Supplemental	Water Flow	Annually
Campaign Box Spring	498,624	3,708,902	Spring	Supplemental	Water Flow	Annually
Campaign Creek 1	491,707	3,709,373	Spring	Supplemental	Water Flow	Annually
Cane Spring	494,889	3,711,092	Spring	Supplemental	Water Flow	Annually
Cedar Spring	497,649	3,709,127	Spring	Supplemental	Water Flow	Annually
Cherry Spring	503,132	3,700,379	Spring	Supplemental	Water Flow	Annually
Cuff Button Spring	492,737	3,703,690	Seep	Supplemental	Water Flow	Annually
Donkey Spring	494,323	3,702,900	Seep	Supplemental	Water Flow	Annually
Eastwater Canyon Spring	503,781	3,699,495	Spring	Supplemental	Water Flow	Annually
Granite Rock Spring	493,252	3,705,138	Spring	Supplemental	Water Flow	Annually
Horseshoe Spring	499,088	3,696,165	stream	Supplemental	Water Flow	Annually
Laurel Spring	505,389	3,709,250	Spring	Supplemental	Water Flow	Annually
Little Mud Spring	495,230	3,704,266	Spring	Supplemental	Water Flow	Annually
Mowing Machine Spring	496,778	3,697,768	Spring	Supplemental	Water Flow	Annually
Pinto Creek 1	500,803	3,706,669	Stream/Spring	Supplemental	Water Flow	Annually

Notes:

m = meter

UTM NAD 83 = Universal Transverse Mercator North American Datum 1983

**Table 13 Supplemental Seeps/Springs Monitoring (Continued)**

Site ID	Coordinates UTM NAD 83		Feature	Program	Description	Monitoring Frequency
	Easting (m)	Northing (m)				
Pinto Creek 2	499,698	3,699,117	Stream/Spring	Supplemental	Water Flow	Annually
Pinto Creek (below ISF)	500,663	3,709,747	Stream	Supplemental	Water Flow	Annually
Pinto Creek ISF	500,638	3,709,562	Spring	Supplemental	Water Flow	Annually
Puddles Spring	495,060	3,703,776	Spring	Supplemental	Water Flow	Annually
Ripper Spring #2	502,918	3,702,619	Spring	Supplemental	Water Flow	Annually
Unnamed Spring 1	502,141	3,702,082	Spring	Supplemental	Water Flow	Annually
Unnamed Spring 2	491,528	3,709,110	Stream/Spring	Supplemental	Water Flow	Annually
W42	502,280	3,695,098	Spring	Supplemental	Water Flow	Annually
Amarillo Spring	501,770	3,707,267	Spring	Supplemental	Water Flow	Annually

Notes:

m = meter

UTM NAD 83 = Universal Transverse Mercator North American Datum 1983

**Table 14 Compliance Seeps/Springs Monitoring**

Site ID	Coordinates UTM NAD 83		Feature	Program	Description	Monitoring Frequency
	Easting (m)	Northing (m)				
MG1-6b	499,872	3,697,295	Spring	APP	Water Quality	Quarterly, Biennially
MG1-12b	500,440	3,698,434	Spring	APP, AZPDES	Water Quality	Quarterly, Biennially
MG1-7A	501,112	3,696,648	Spring	APP	Water Quality	Quarterly, Biennially
North Draw 1	500,001	3,698,650	Spring	APP	Water Quality	Quarterly, Biennially
MPO-1b	502,378	3,694,831	Seep	AZPDES	Water Quality	Quarterly
MG2-8b	500,311	3,693,291	Seep	AZPDES	Water Quality	Quarterly

Notes:

m = meter

APP = Aquifer Protection Permit

AZPDES = Arizona Pollutant Discharge Elimination System

UTM NAD 83 = Universal Transverse Mercator North American Datum 1983

**Table 15 Schedule for Compliance Reporting**

What	When	Notes	Period	Due
APP Groundwater Report	Annual	Report includes: <ul style="list-style-type: none"> <li>• Laboratory Reports</li> <li>• Potentiometric Surface Map</li> <li>• Hydrogeologic Cross Sections</li> <li>• BADCT Site Inspections</li> <li>• Tailings Engineer of Record Report</li> <li>• (Demonstration of PCCZ every five years)</li> </ul>	January through December	April 30 of the following year
APP SMRFs	Quarterly	Report includes: <ul style="list-style-type: none"> <li>• Water Quality Results</li> </ul>	calendar quarter	end of the month following quarter
AZPDES DMRs	Monthly	Report includes: <ul style="list-style-type: none"> <li>• Discharge Monitoring Reports (DMRs)</li> <li>• Whole Effluent Toxicity (WET) Reports</li> <li>• Laboratory Reports</li> <li>• Flow records</li> </ul> Method detection limit studies, if performed	calendar month	28th of the month following the end of a monitoring period
AZPDES Report	Annual	Report includes: <ul style="list-style-type: none"> <li>• Discharge Monitoring Results</li> <li>• Map of monitoring and any new seep locations</li> <li>• Laboratory Reports</li> <li>• Quarterly BMP Inspections</li> <li>• Comprehensive Facility Inspection (CFI)</li> <li>• Updates to BMP Plan, if made</li> </ul>	January through December	July 15th

**Table 16 Schedule for Supplemental Reporting**

What	When	Notes	Mon. Period	Due
Well Instrumentation Report	Quarterly until EIS is issued (expected end of Q2 2021)	Report includes: <ul style="list-style-type: none"> <li>• Pumping data</li> <li>• Instrumented water levels</li> <li>• Summed flow from wells that discharge to pipelines crossing TNF lands</li> </ul> Reference: (AJAX, 2019, Well Instrumentation Work Plan)	Calendar quarter	End of month following quarter
Well Instrumentation Report	Annual until EIS is issued (expected end of Q2 2021)	Report includes: <ul style="list-style-type: none"> <li>• Pumping data</li> <li>• Instrumented water levels</li> <li>• Summed flow from wells that discharge to pipelines crossing TNF lands</li> </ul> Reference: (AJAX, 2019, Well Instrumentation Work Plan)	4 Preceding quarters	May 31 of the following year
Seep & Spring Survey	Annual	Report includes: <ul style="list-style-type: none"> <li>• Status of each seep and spring</li> <li>• Photo of each seep or spring</li> <li>• Flow</li> </ul>	June	May 31 of the following year
Comprehensive Supplemental Water Resources Monitoring Report	Annual	Comprehensive Annual Report (this Plan) includes: Water Levels: <ul style="list-style-type: none"> <li>• Hydrographs</li> <li>• Analysis of trends</li> <li>• Evaluation of change over year</li> <li>• Comparison to 2018 baseline values</li> </ul> Tailings Indicator Parameters: <ul style="list-style-type: none"> <li>• Concentration graphs</li> <li>• Analysis of trends</li> <li>• Evaluation of change over year</li> <li>• Comparison to 2018 baseline values</li> </ul>	January through December	May 31 of the following year





**Table 16 Schedule for Supplemental Reporting (Continued)**

What	When	Notes	Mon. Period	Due
Supplemental Water Resources Report	Annual	Surface Water Flows: <ul style="list-style-type: none"> <li>• Graph of change</li> <li>• Analysis of trends</li> <li>• Evaluation of change over year</li> <li>• Comparison to 2018 baseline values</li> </ul> Seep & Spring Flows: <ul style="list-style-type: none"> <li>• Graph of change</li> <li>• Analysis of trends</li> <li>• Evaluation of change over year</li> <li>• Comparison to 2018 baseline values</li> </ul> Water Quality Samples: <ul style="list-style-type: none"> <li>• Dates, times, and methods of sample collection</li> <li>• Laboratory results, including data validation</li> </ul> Pumping Data (Well Instrumentation Report): <ul style="list-style-type: none"> <li>• instrumented water levels</li> <li>• -year water level trend graphs</li> <li>• groundwater elevation contour map</li> <li>• summed flow from wells that discharge to pipelines crossing TNF lands</li> </ul> Reference: (AJAX, 2019, Well Instrumentation Work Plan)	January through December	May 31 of the following year
GW Model Update	Biennial 2021 through 2027, every 5 years thereafter	Report includes: <ul style="list-style-type: none"> <li>• Data added to model, including updates to pumping and calibration targets</li> <li>• Changes, if any, to the geologic model</li> <li>• Validation of previous version of the model or recalibration, as necessary</li> <li>• Results of validation or changes to parameters and results of recalibration</li> <li>• Explanation of significant changes to projected water levels or drawdown levels from previous model projections.</li> </ul>	January through December	May 31 of the following year

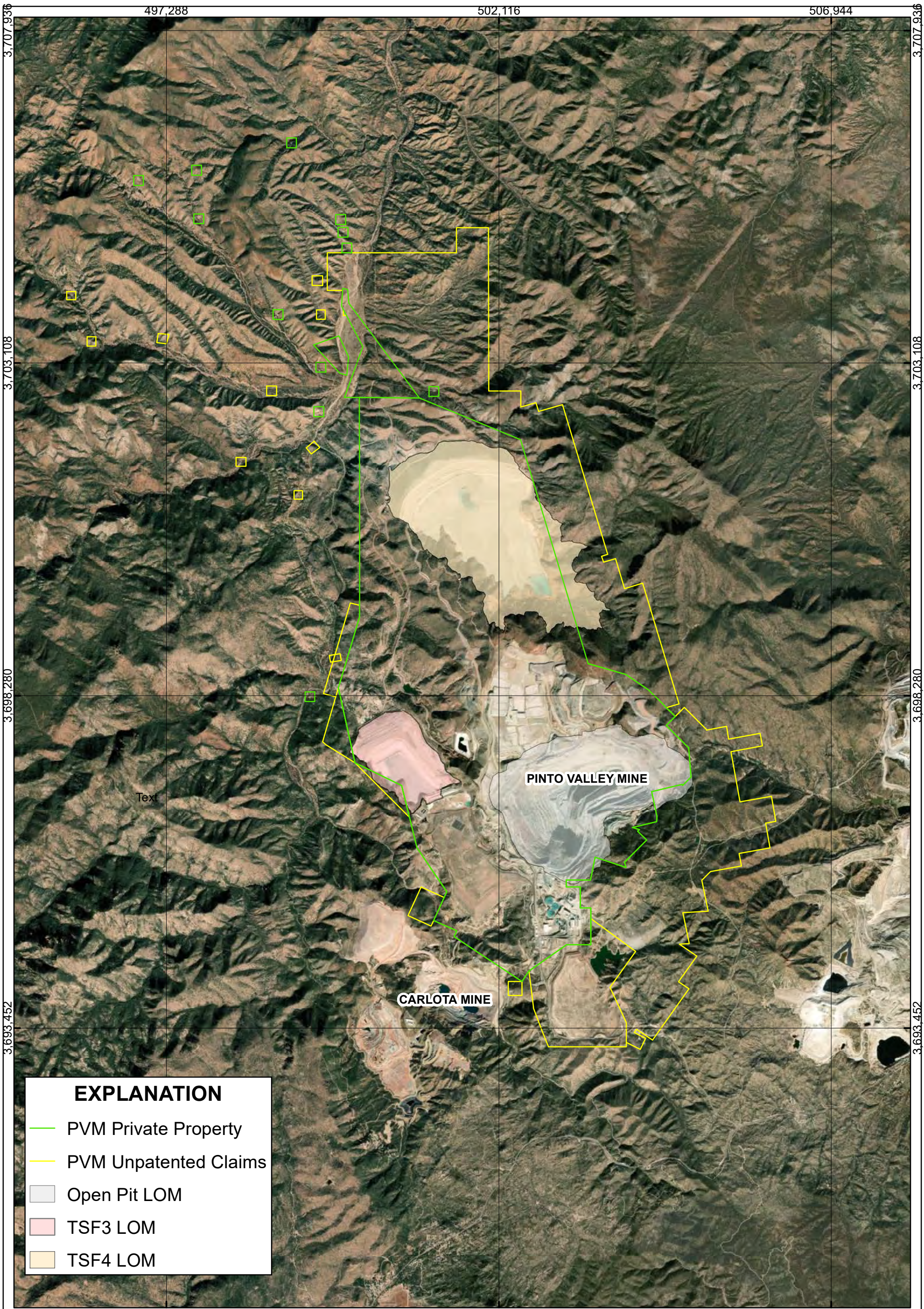
# Figures





EXPLANATION	
	PVM Private Property
	PVM Unpatented Claims
	Open Pit LOM
	TSF3 LOM
	TSF4 LOM

N

Miles

0 1



NAD 1983 UTM Zone 12N

DESIGN:	OF	DRAWN:	OF	REVIEWED:	CH
SCALE:	1 inch = 4,167 feet		DATE:	5/26/2020	
FILE:	Figure_01_05262020_GeneralLocation.mxd				

**PVM GENERAL LOCATION**

DRAWING TITLE: <b>Comprehensive Water Resources Monitoring Plan</b>	
ISSUED FOR: PINTO VALLEY MINING CORP	
DRAWING NO. <b>FIGURE 1</b>	REVISION NO.
SRK JOB NO. <b>219500.590</b>	<b>A</b>

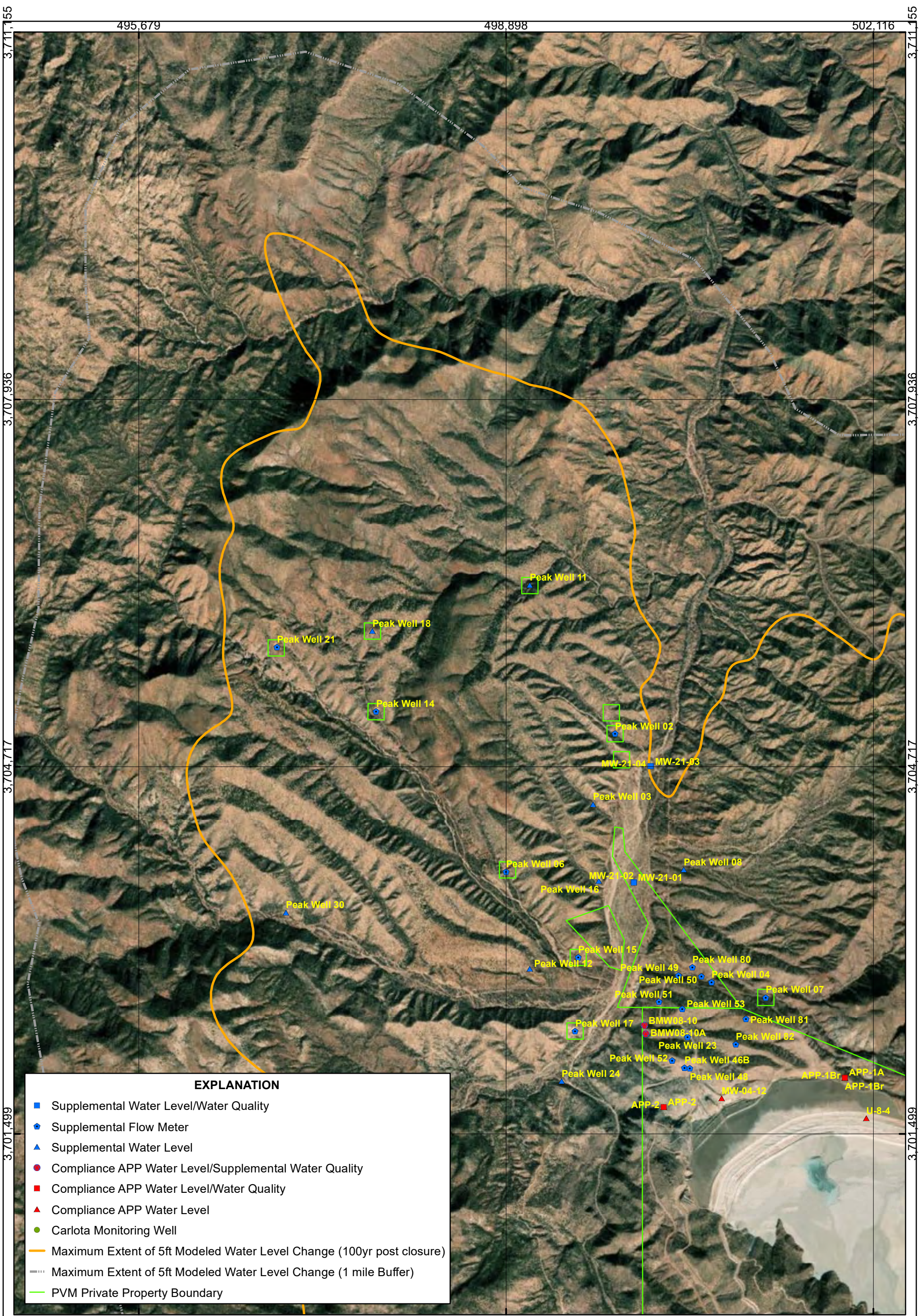

EXPLANATION	
<span style="color: blue;">■</span>	Supplemental Water Level/Water Quality
<span style="color: blue;">●</span>	Supplemental Flow Meter
<span style="color: blue;">▲</span>	Supplemental Water Level
<span style="color: red;">●</span>	Compliance APP Water Level/Supplemental Water Quality
<span style="color: red;">■</span>	Compliance APP Water Level/Water Quality
<span style="color: red;">▲</span>	Compliance APP Water Level
<span style="color: green;">●</span>	Carlota Monitoring Well
<span style="color: orange;">—</span>	Maximum Extent of 5ft Modeled Water Level Change (100yr post closure)
<span style="color: grey;">- - -</span>	Maximum Extent of 5ft Modeled Water Level Change (1 mile Buffer)
<span style="color: green;">—</span>	PVM Private Property Boundary

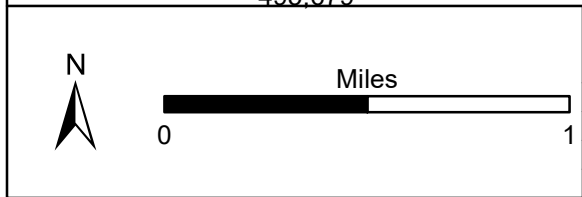

NAD 1983 UTM Zone 12N			
DESIGN:	OF	DRAWN:	OF
SCALE:	1 inch = 2,500 feet	DATE:	5/26/2020
FILE:	Fig_02R_05262020.mxd		

## MONITORING WELL NETWORK EXISTING AND SUPPLEMENTAL (NORTH)

DRAWING TITLE: <b>Comprehensive Water Resources Monitoring Plan</b>	
ISSUED FOR: PINTO VALLEY MINING CORP	
DRAWING NO. <b>FIGURE 2</b>	REVISION NO.
SRK JOB NO. <b>219500.590</b>	<b>A</b>

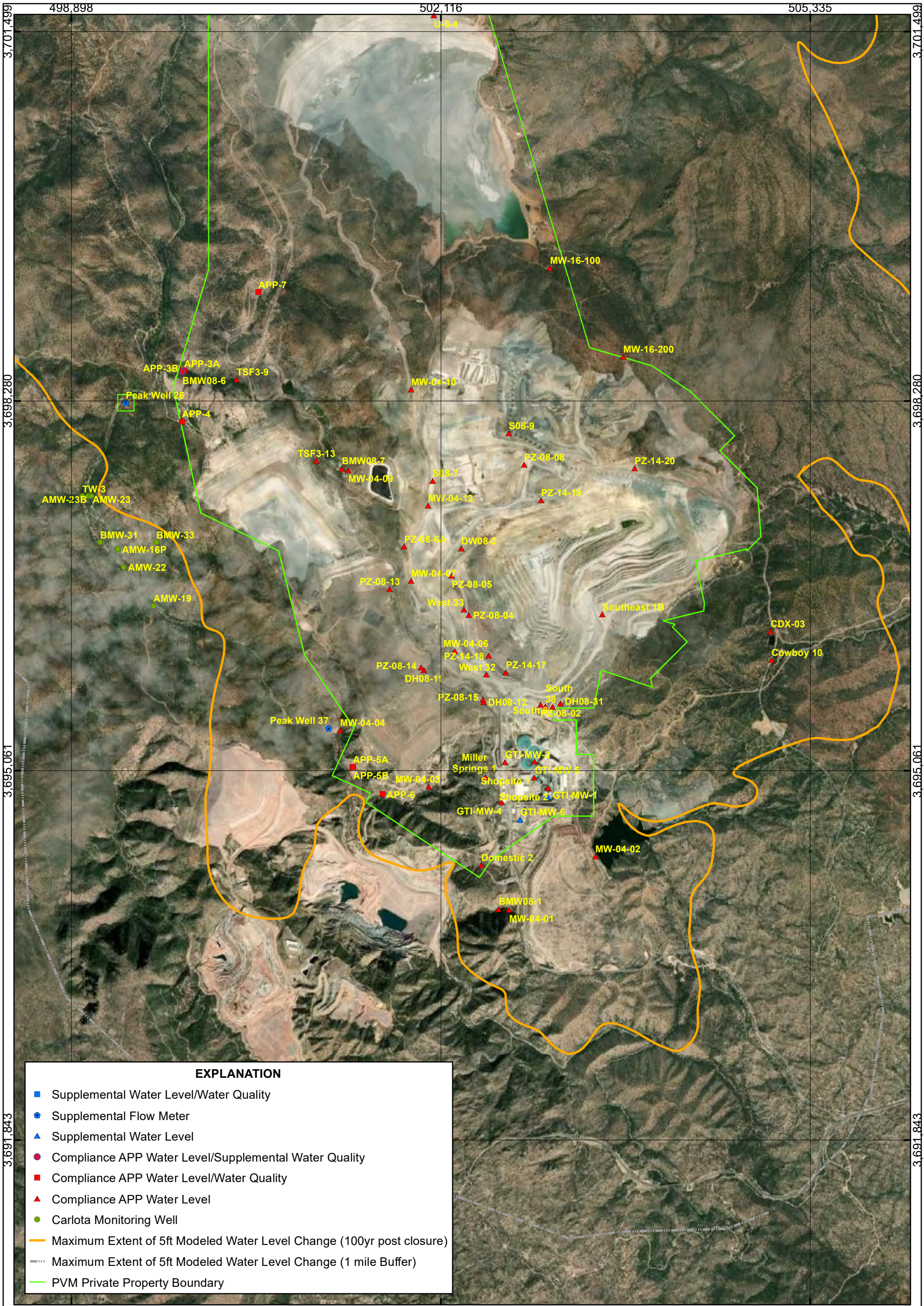

EXPLANATION	
<span style="color: blue;">■</span>	Supplemental Water Level/Water Quality
<span style="color: blue;">◆</span>	Supplemental Flow Meter
<span style="color: blue;">▲</span>	Supplemental Water Level
<span style="color: red;">●</span>	Compliance APP Water Level/Supplemental Water Quality
<span style="color: red;">■</span>	Compliance APP Water Level/Water Quality
<span style="color: red;">▲</span>	Compliance APP Water Level
<span style="color: green;">●</span>	Carlota Monitoring Well
<span style="color: orange;">—</span>	Maximum Extent of 5ft Modeled Water Level Change (100yr post closure)
<span style="color: grey;">---</span>	Maximum Extent of 5ft Modeled Water Level Change (1 mile Buffer)
<span style="color: green;">—</span>	PVM Private Property Boundary

<p>N</p> <p>Miles</p>	<p>NAD 1983 UTM Zone 12N</p> <table border="1"> <tr> <td>DESIGN:</td> <td>OF</td> <td>DRAWN:</td> <td>OF</td> <td>REVIEWED:</td> <td>CH</td> </tr> <tr> <td>SCALE:</td> <td colspan="2">1 inch = 2,500 feet</td> <td>DATE:</td> <td colspan="2">6/24/2020</td> </tr> <tr> <td>FILE:</td> <td colspan="5">Fig_02R_06242020.mxd</td> </tr> </table>	DESIGN:	OF	DRAWN:	OF	REVIEWED:	CH	SCALE:	1 inch = 2,500 feet		DATE:	6/24/2020		FILE:	Fig_02R_06242020.mxd					<h2>MONITORING WELL NETWORK EXISTING AND SUPPLEMENTAL (SOUTH)</h2>	<p>DRAWING TITLE: <b>Comprehensive Water Resources Monitoring Plan</b></p> <p>ISSUED FOR: <b>PINTO VALLEY MINING CORP</b></p> <p>DRAWING NO. <b>FIGURE 3</b></p> <p>SRK JOB NO. <b>219500.590</b></p> <p>REVISION NO. <b>A</b></p>
DESIGN:	OF	DRAWN:	OF	REVIEWED:	CH																
SCALE:	1 inch = 2,500 feet		DATE:	6/24/2020																	
FILE:	Fig_02R_06242020.mxd																				

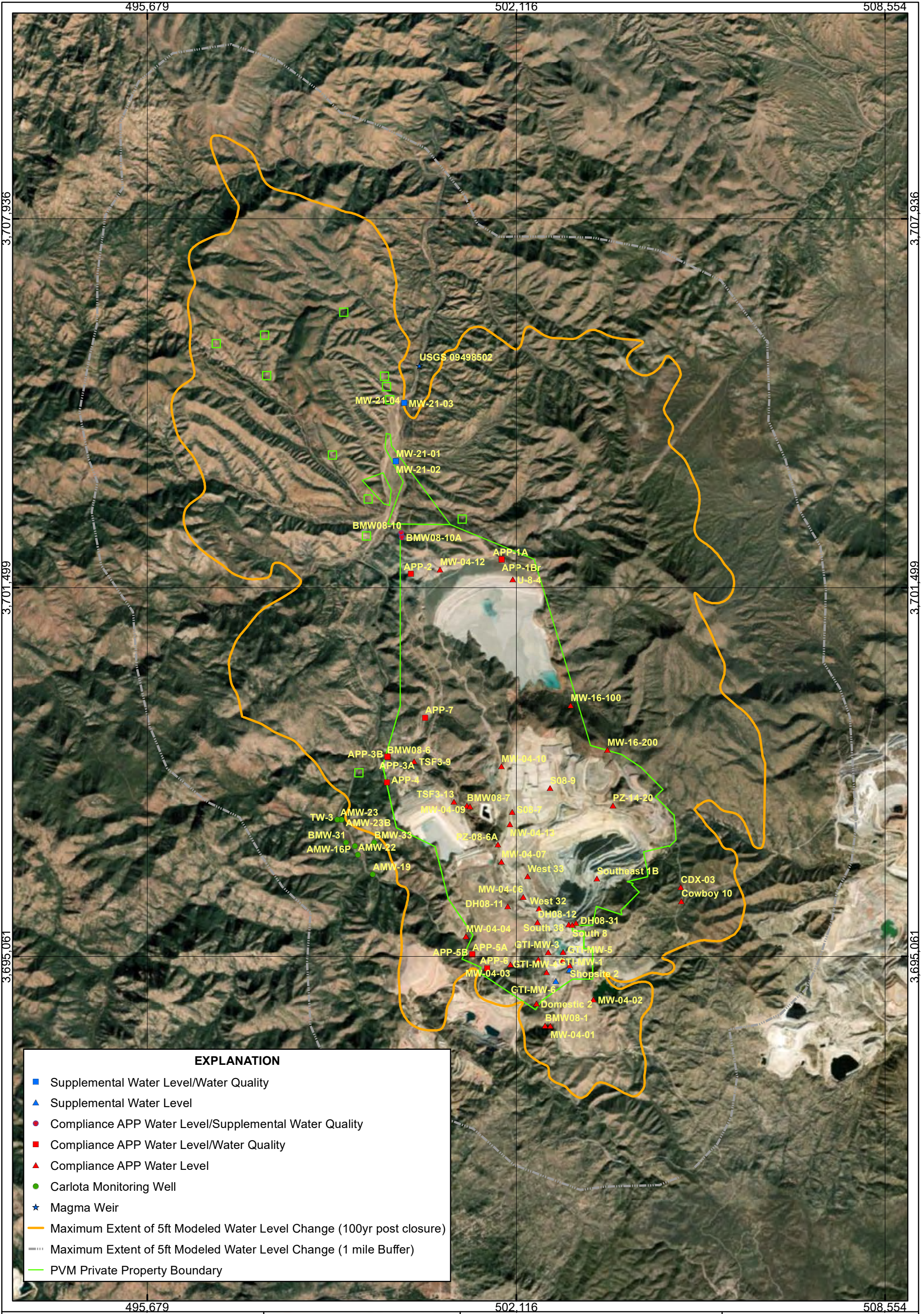

EXPLANATION	
■	Supplemental Water Level/Water Quality
▲	Supplemental Water Level
●	Compliance APP Water Level/Supplemental Water Quality
■	Compliance APP Water Level/Water Quality
▲	Compliance APP Water Level
●	Carlota Monitoring Well
★	Magma Weir
— (Yellow)	Maximum Extent of 5ft Modeled Water Level Change (100yr post closure)
- - - - (Grey)	Maximum Extent of 5ft Modeled Water Level Change (1 mile Buffer)
— (Green)	PVM Private Property Boundary



<b>srk consulting</b>			
NAD 1983 UTM Zone 12N			
DESIGN:	DRAWN:	REVIEWED:	VS
SCALE:	1 inch = 5,000 feet		DATE: 6/24/2020
FILE:	Figure_03R_06242020.mxd		

## MANUAL GROUNDWATER MONITORING WELLS

DRAWING TITLE: <b>Comprehensive Water Resources Monitoring Plan</b>	
ISSUED FOR: PINTO VALLEY MINING CORP	
DRAWING NO. <b>FIGURE 4</b>	REVISION NO.
SRK JOB NO. <b>219500.590</b>	<b>A</b>

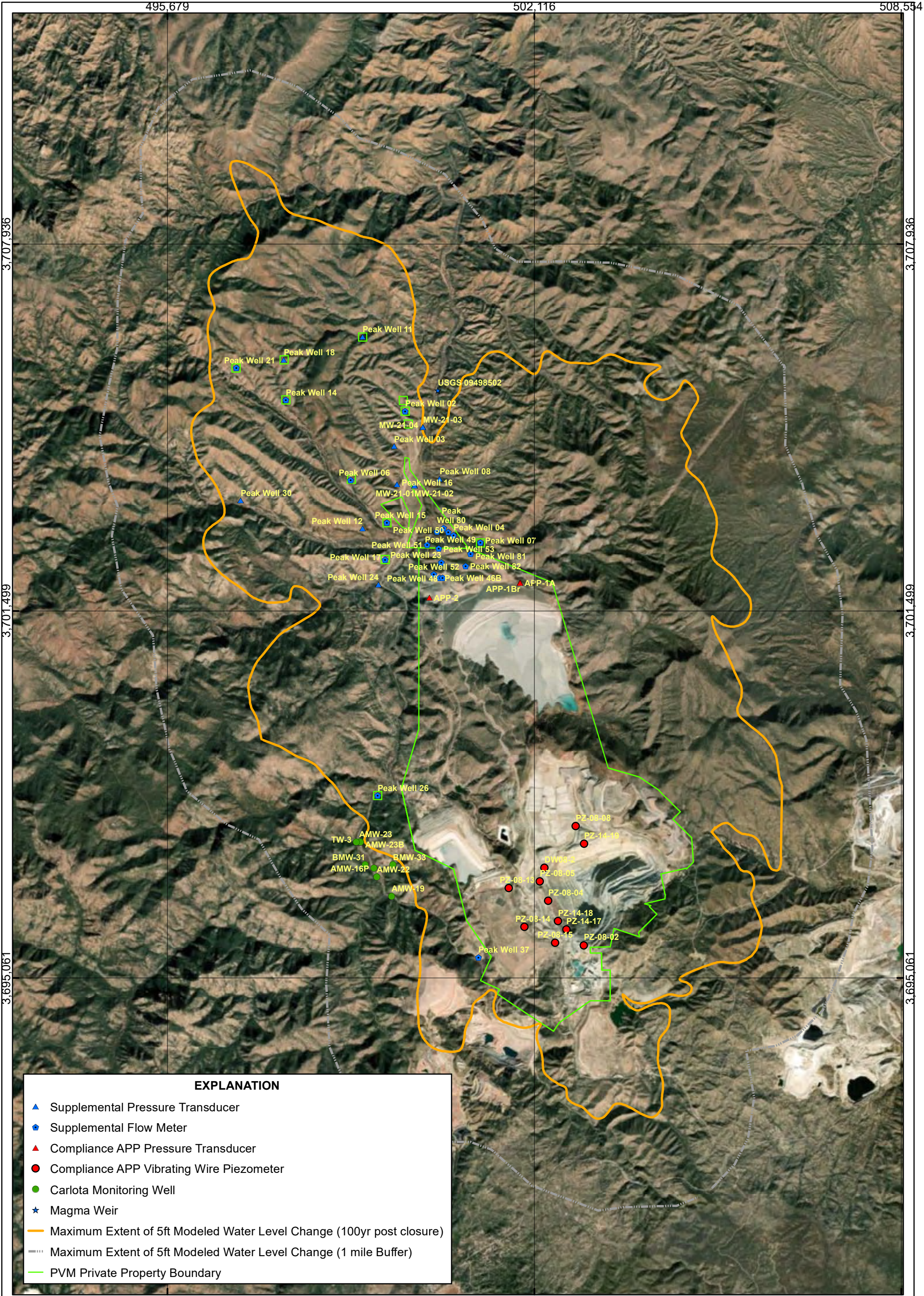

EXPLANATION	
▲	Supplemental Pressure Transducer
●	Supplemental Flow Meter
▲	Compliance APP Pressure Transducer
●	Compliance APP Vibrating Wire Piezometer
●	Carlota Monitoring Well
★	Magma Weir
—	Maximum Extent of 5ft Modeled Water Level Change (100yr post closure)
- - -	Maximum Extent of 5ft Modeled Water Level Change (1 mile Buffer)
—	PVM Private Property Boundary

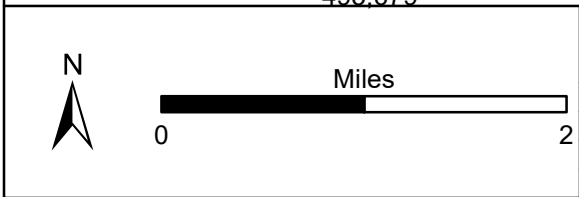

<b>srk consulting</b>			
NAD 1983 UTM Zone 12N			
DESIGN:	OF	DRAWN:	OF
SCALE:	1 inch = 5,000 feet	DATE:	6/24/2020
FILE:	Figure_04R_06242020.mxd		

## INSTRUMENTED MONITORING WELLS

DRAWING TITLE: <b>Comprehensive Water Reesources Monitoring Plan</b>	
ISSUED FOR: PINTO VALLEY MINING CORP	
DRAWING NO. <b>FIGURE 5</b>	REVISION NO.
SRK JOB NO. <b>219500.590</b>	<b>A</b>

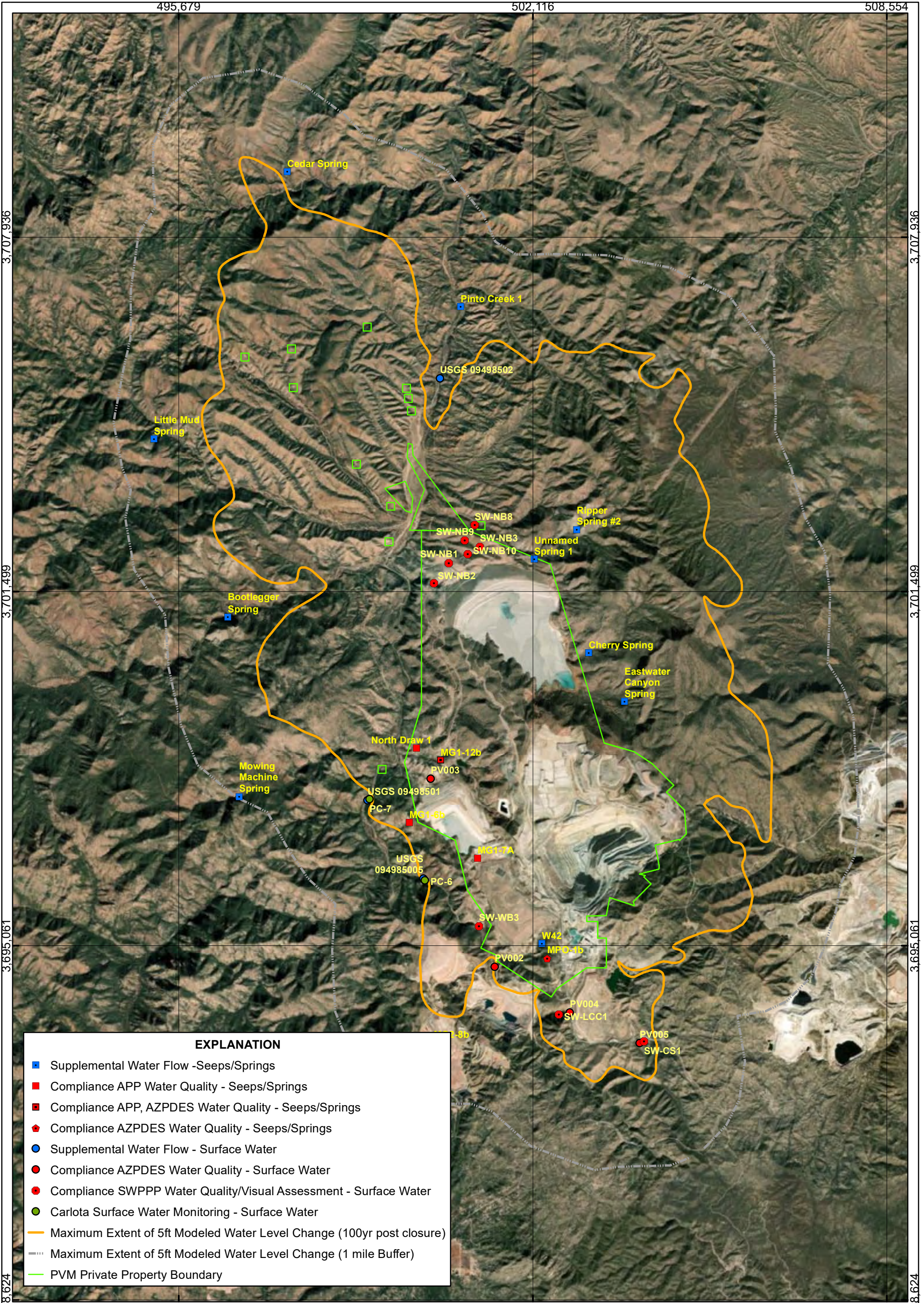

**EXPLANATION**

- Supplemental Water Flow -Seeps/Springs
- Compliance APP Water Quality - Seeps/Springs
- Compliance APP, AZPDES Water Quality - Seeps/Springs
- ◆ Compliance AZPDES Water Quality - Seeps/Springs
- Supplemental Water Flow - Surface Water
- Compliance AZPDES Water Quality - Surface Water
- Compliance SWPPP Water Quality/Visual Assessment - Surface Water
- Carlota Surface Water Monitoring - Surface Water
- Maximum Extent of 5ft Modeled Water Level Change (100yr post closure)
- - - Maximum Extent of 5ft Modeled Water Level Change (1 mile Buffer)
- PVM Private Property Boundary

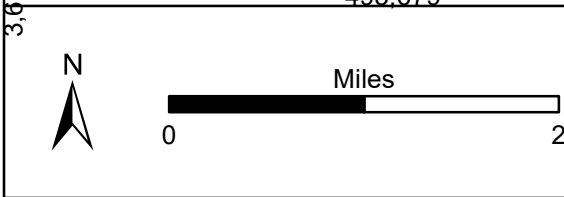

NAD 1983 UTM Zone 12N			
DESIGN:	OF	DRAWN:	OF
SCALE:	1 inch = 5,208 feet		DATE:
FILE:	Figure_06_05262020.mxd		

**SURFACE WATER  
AND  
SEEPS/SPRINGS**

DRAWING TITLE: <b>Comprehensive Water Resources Monitoring Plan</b>	
ISSUED FOR: <b>PINTO VALLEY MINING CORP</b>	
DRAWING NO. <b>FIGURE 6</b>	REVISION NO.
SRK JOB NO. <b>219500.590</b>	<b>A</b>

# Appendices

## **Appendix A: Standard Operating Procedures for Monitor Well Installation**

Scientific Engineering Response and Analytical Services for U.S.  
Environmental Protection Agency





# STANDARD OPERATING PROCEDURES

SOP: 2048  
PAGE: 1 of 16  
REV: 0.0  
DATE: 07/12/01

## MONITOR WELL INSTALLATION

---

### CONTENTS

- 1.0 SCOPE AND APPLICATION\*
- 2.0 METHOD SUMMARY
  - 2.1 Hollow-Stem Augering\*
  - 2.2 Cable Tool Drilling\*
  - 2.3 Rotary Drilling
    - 2.3.1 Mud Rotary Method\*
    - 2.3.2 Air Rotary Method\*
- 3.0 SAMPLE PRESERVATION, CONTAINERS, HANDLING, AND STORAGE\*
- 4.0 INTERFERENCES AND POTENTIAL PROBLEMS\*
  - 4.1 Auger Drilling\*
  - 4.2 Cable Tool Drilling\*
  - 4.3 Rotary Drilling
    - 4.3.1 Mud Rotary Drilling\*
    - 4.3.2 Air Rotary Drilling\*
- 5.0 EQUIPMENT/APPARATUS\*
- 6.0 REAGENTS\*
- 7.0 PROCEDURES\*
  - 7.1 Preparation\*
  - 7.2 Field Preparation
  - 7.3 Well Construction
    - 7.3.1 Bedrock Wells\*
    - 7.3.2 Overburden Well Construction\*
- 7.4 Well Development
- 8.0 CALCULATIONS\*
- 9.0 QUALITY ASSURANCE/QUALITY CONTROL\*



# STANDARD OPERATING PROCEDURES

SOP: 2048  
PAGE: 2 of 16  
REV: 0.0  
DATE: 07/12/01

## MONITOR WELL INSTALLATION

---

### CONTENTS (cont)

- 10.0 DATA VALIDATION
- 11.0 HEALTH AND SAFETY\*
- 12.0 REFERENCES\*
- 13.0 APPENDICES\*
  - A Figures

\*These sections affected by Revision 0.0

SUPERSEDES: SOP #2048, Revision 0.0; 2/29/96; US EPA Contract EP-W-09-031.



# STANDARD OPERATING PROCEDURES

SOP: 2048  
PAGE: 3 of 16  
REV: 0.0  
DATE: 07/12/01

## MONITOR WELL INSTALLATION

---

### 1.0 SCOPE AND APPLICATION

The purpose of this Standard Operating Procedure (SOP) is to provide an overview of the methods used for the installation of groundwater monitor wells. Monitor well installation creates a permanent access for the collection of samples to assess groundwater quality and the hydrogeologic properties of the aquifer, in which contaminants may exist. Such wells should not alter the medium which is being monitored.

The most commonly used drilling methods are: hollow-stem auger, cable tool, and hydraulic rotary. Rotary drilling can utilize mud rotary or air rotary methods.

These are standard (i.e., typically applicable) operating procedures which may be varied or changed as required, depending on site conditions, equipment limitations, or limitations imposed by the procedure. In all instances, the ultimate procedures employed should be documented and associated with the final report.

Mention of trade names or commercial products does not constitute United States Environmental Protection Agency (U.S. EPA) endorsement or recommendation for use.

### 2.0 METHOD SUMMARY

There is no ideal monitor well installation method for all conditions; therefore, hydrogeologic conditions at the site, as well as project objectives, must be considered before deciding which drilling method is appropriate.

#### 2.1 Hollow-Stem Augering

Outside diameters of hollow-stem augers generally range from 6.25 inches to 22 inches with corresponding inner diameters ranging from 2.25 inches to 13 inches. Auger lengths are usually 5 feet, which allows relatively easy handling. However, lengths of 10 or 20 feet may be used for deeper holes drilled with machines capable of handling the extended lengths. Formation samples can be taken in a number of ways, depending on the accuracy required. Cuttings may suffice for shallow depths but become less representative with depth, particularly below the water table. The most accurate samples are obtained with various coring devices, such as split spoons or Shelby tubes, which can be used inside the augers. Continuous cores may be taken with a thin-walled tube that is inserted into the lowest auger and locked in place. The tube is retracted with a wire line and hoist after the hole has been advanced the length of the auger. A bottom plug in the cutting head or bit prevents cuttings from entering the augers until the first core sample is taken and the plug is knocked out.

In unconsolidated material, the augers serve as a temporary casing. Gravel-packed wells can be constructed inside the augers and then the augers are withdrawn. Well development is usually less difficult than with wells drilled by the mud rotary method because a bentonite drilling fluid is not normally used.

#### 2.2 Cable Tool Drilling

Cable tool drilling is a percussion method in which a bit, attached to a weighted drilling string, is



# STANDARD OPERATING PROCEDURES

SOP: 2048  
PAGE: 4 of 16  
REV: 0.0  
DATE: 07/12/01

## MONITOR WELL INSTALLATION

---

alternately lifted and dropped. The drilling string, consists (bottom to top) of the drill bit, drill stem, drilling jars, socket, and wire cable. A walking beam on the drilling rig provides the lifting and dropping motion to the wire cable and hence to the drilling string. The repeated action breaks or loosens the formation material, which mixes with formation water, or water added to the borehole by the operator, to form a slurry. The slurry facilitates the removal of the cuttings, which are periodically removed from the hole with a bailer. In unconsolidated formations, steel casing must be driven or pushed into the ground as the drilling progresses in order to maintain the wall of the borehole and prevent collapse. A hardened steel drive shoe on the bottom end of the casing prevents damage during driving. A well may then be constructed inside the steel casing before the casing is pulled back. In consolidated formations, the casing may be driven through the weathered zone and seated in solid rock. The hole below the casing may remain open or may be fitted with a smaller diameter inner casing and screen, depending on the sampling requirements. Depending on formation material, extensive well development may often not be necessary.

### 2.3 Rotary Drilling

#### 2.3.1 Mud Rotary Method

In the mud rotary method, the drill bit is rotated rapidly to cut the formation material and advance the borehole. The drill bit is attached to hollow drilling rods, which transfer power from the rig to the bit. In conventional rotary drilling, cuttings are removed by pumping drilling fluid (water, or water mixed with bentonite or other additives) down through the drill rods and bit, and up the annulus between the borehole and the drill rods. The drilling fluid flows into a mud pit where the cuttings settle out, and the “fluid” is pumped back down the drill rods. The drilling fluid cools and lubricates the bit and prevents the borehole from collapsing in unconsolidated formations.

Sampling may be done from the cuttings, but these types of samples are generally mixed and the amount of fine material may not be accurately represented. Coring may be done through the drill rods and bit, if a coring bit (with a center opening big enough to allow passage of the coring tube) is used. When drilling unconsolidated formations, a temporary surface or shallow casing may have to be installed in order to prevent cross-contamination, hole collapse, or wall erosion by the drilling fluid. Casing (riser pipe), screen, and gravel pack are usually installed in the open hole or through the surface casing. Once the well is constructed, extensive well development may be necessary in order to remove drilling fluid from the formation.

#### 2.3.2 Air Rotary Method

The air rotary method uses air as the drilling fluid. Air is forced down the drill rods by an air compressor, escapes out of the bit and returns to the surface in the annular space between the hole wall and the drill string. Cuttings are moved out of the hole by the ascending air and collect around the rig. Cuttings are mixed and may not always be representative of the depth currently being drilled. In the conventional air rotary method, the drill string operates in a manner similar to that described for the mud rotary



# STANDARD OPERATING PROCEDURES

SOP: 2048  
PAGE: 5 of 16  
REV: 0.0  
DATE: 07/12/01

## MONITOR WELL INSTALLATION

---

system. In a "hammer" or "down-the-hole" air rotary method, the bit is pneumatically driven rapidly against the rock in short strokes while the drilling string slowly rotates. The use of air rotary methods are generally limited to consolidated and semi-consolidated formations. Casing is often used in semi-consolidated formations and through the weathered portion of consolidated formations to prevent hole collapse. In environmental work, the air supply must be filtered to prevent introduction of contamination (typically oil from the air compressor) into the borehole.

### 3.0 SAMPLE PRESERVATION, CONTAINERS, HANDLING, AND STORAGE

Often, a primary objective of the drilling program is to obtain representative lithologic or environmental samples. The most common techniques for retrieving samples are:

In unconsolidated formations:

- Split spoon sampling, carried out continuously or at discrete intervals during drilling
- Shelby tube sampling, when an undisturbed sample is required from clay or silt soils, especially for geotechnical evaluation or chemical analysis
- Cutting collection, when a general lithologic description and approximate depths are sufficient

In consolidated formations:

- Rock coring at continuous or discrete intervals
- Cutting collection, when a general lithologic description and approximate depths are sufficient

The amount of sample to be collected, the proper sample container (i.e., glass, plastic), chemical preservation, and storage requirements are dependent on the matrix being sampled and the parameter(s) of interest, and are discussed in ERT/SERAS SOP #2003, *Sample Storage, Preservation and Handling*.

### 4.0 INTERFERENCES AND POTENTIAL PROBLEMS

The advantages and disadvantages of the various drilling methods are summarized below.

#### 4.1 Auger Drilling

The advantages of auger drilling are:

- Relatively fast and inexpensive
- Because augers act as temporary casing, drilling fluids are not used, resulting in reduced well development

The disadvantages of auger drilling are:

- Very slow or impossible to use in coarse materials such as cobble or boulders
- Cannot be used in consolidated formations and is generally limited to depths of approximately 100 feet below ground surface in order to be efficient



# STANDARD OPERATING PROCEDURES

SOP: 2048  
PAGE: 6 of 16  
REV: 0.0  
DATE: 07/12/01

## MONITOR WELL INSTALLATION

---

### 4.2 Cable Tool Drilling

The advantages of cable tool drilling are:

- Relatively inexpensive with minimum labor requirements
- Water table and water bearing zones are easily identified
- Driven casing stabilizes the open borehole and minimizes potential for cross-contamination
- Especially successful in caving formations or formations containing boulders
- Accurate formation samples can usually be obtained from cuttings

The disadvantages of cable tool drilling are:

- Extremely slow rate of drilling
- Necessity to drive casing may limit depth in large diameter holes.

### 4.3 Rotary Drilling

#### 4.3.1 Mud Rotary Drilling

The advantages of mud rotary drilling are:

- Fast, typically more than 100 feet of borehole advancement per day
- Provides an open borehole, necessary for some types of geophysical logging and other tests

The disadvantages of mud rotary drilling are:

- Potential for cross-contamination of water-bearing zones
- Drill cuttings may be mixed and not accurately represent lithologies at a given drilling depth
- Drilling mud may alter the groundwater chemistry
- Water levels can only be determined by constructing wells
- Drilling mud may change local permeability of the formation and may not be entirely removed during well development
- Disposal of large volumes of drilling fluid and cuttings may be necessary if they are contaminated

#### 4.3.2 Air Rotary Drilling

The advantages of air rotary drilling are:

- Fast, typically more than 100 feet of borehole advancement a day
- Preliminary estimates of well yields and water levels are often possible
- No drilling mud to plug the borehole

The disadvantages of air rotary drilling are:



# STANDARD OPERATING PROCEDURES

SOP: 2048  
PAGE: 7 of 16  
REV: 0.0  
DATE: 07/12/01

## MONITOR WELL INSTALLATION

---

- Generally cannot be used in unconsolidated formations
- In contaminated zones, the use of high-pressure air may pose a significant hazard to the drill crew because of transport of contaminated material up the hole
- Introduction of air to the groundwater could reduce concentration of volatile organic compounds

### 5.0 EQUIPMENT/APPARATUS

The following equipment is necessary for the site geologist:

- Metal clipboard box case (container for well logs)
- Ruler
- Depth sounder
- Water level indicator
- Health and safety gear
- Sample collection jars
- Trowels
- Description aids (Munsell color change, grain size charts, etc.)
- Field Logbook

Equipment and tools required for well installation are provided by the drilling contractor.

### 6.0 REAGENTS

Reagents are not required for preservation of soil samples. Samples should, however, be cooled to 4<sup>0</sup>C and protected from sunlight in order to minimize degradation and any potential reaction due to the light sensitivity of the sample. Decontamination solutions are specified in ERT/SERAS SOP# 2006, *Sampling Equipment Decontamination*, and the site-specific work plan.

### 7.0 PROCEDURES

#### 7.1 Preparation

All drilling and well installation programs must be planned and supervised by a licensed professional geologist/hydrogeologist.

The planning, selection and implementation of any monitor well installation program should include the following:

- Review existing data on site geology and hydrogeology including publications, air photos, water quality data, and existing maps. These may be obtained from local, state or federal agencies
- Assess site to determine potential access problems for drill rig, locate water supply sources, establish equipment storage area, and observe outcrops
- Perform utilities check, note location of underground utilities and of overhead electrical



# STANDARD OPERATING PROCEDURES

SOP: 2048  
PAGE: 8 of 16  
REV: 0.0  
DATE: 07/12/01

## MONITOR WELL INSTALLATION

---

wires

- Prepare a site-specific Health and Safety Plan (HASP)
- Select drilling, sampling and well development methods
- Determine well construction specifications (i.e., casing and screen materials, casing and screen diameter, screen length and screen interval, filter pack and screen slot size)
- Determine need for containing drill cuttings and fluids and their method of disposal
- Prepare the site-specific Work Plan (WP) including all of the above
- Prepare and execute the drilling contract

### 7.2 Field Preparation

Prior to mobilization, the drill rig and all associated equipment must be thoroughly decontaminated by a steam/pressure washer to remove all oil, grease, mud, etc. Before drilling each boring, all "down-the-hole" drill equipment should be steam cleaned and rinsed with potable water to minimize cross-contamination. Special attention should be given to the threaded section of the casings and to the drill rods. All drilling equipment must be steam-cleaned at completion of the project to ensure that no contamination is transported from the sampling site.

### 7.3 Well Construction

The well casing material should not interact with the groundwater. Well casings for environmental projects are usually constructed of polyvinyl chloride (PVC), Teflon, fiberglass, or stainless steel. Details of the construction methods are given in Sections 7.3.1 and 7.3.2.

#### 7.3.1 Bedrock Wells

Wells installed in bedrock will be drilled using the air or mud rotary method. Crystalline rock wells are usually drilled most efficiently with the air rotary method while consolidated sedimentary formations are drilled using either the air rotary or mud rotary method. The compressed air supply will be filtered prior to introduction into the borehole to remove oil or other contaminants. Bedrock wells may be completed as an open-hole, providing that borehole cave-in is not a possibility.

Bedrock wells will be advanced with air or mud rotary methods until a minimum of 5 feet of competent rock has been drilled. Minimum borehole diameter will be 8 inches. The drill string will then be pulled from the borehole and 6-inch inner diameter (I.D.) Schedule 80 or 40 polyvinyl chloride (PVC) casing inserted. Portland cement/bentonite grout will be pumped through a tremie pipe (placed at the bottom of the borehole) into the annular space outside the casing. After the grout has set (minimum of 24 hours), the cement will be drilled out (if needed) and the borehole advanced to the desired depth. Figure 1 (Appendix A) shows typical construction details for an open-hole bedrock well.





# STANDARD OPERATING PROCEDURES

SOP: 2048  
PAGE: 9 of 16  
REV: 0.0  
DATE: 07/12/01

## MONITOR WELL INSTALLATION

---

The preferred method of well completion for the bedrock wells will be open-hole. However, if the open borehole is subject to cave-in, the well will be completed as a screened and cased sand-packed well. For details of completion, see Section 7.3.2.

### 7.3.2 Overburden Well Construction

Any of the drilling methods discussed in this SOP can be used to drill or set a well in the overburden. The hollow-stem augering method is the preferred choice for shallow (<100 feet total depth) overburden wells because the well can be constructed inside of the augers. Details of the construction are provided below and are shown in Figure 2 (Appendix A).

1. The screen slot size will be determined by the site geologist/hydrogeologist, based on the sand-pack size. The length of screen used will be site-dependent. Casing sections will be flush-threaded. Screw-threaded bottom plugs will be used. To prevent introduction of contaminants into the well, no glue-connected fittings will be used. Each piece of PVC pipe, screen, and the bottom plug will be steam-cleaned before lowering into the borehole. The site geologist/hydrogeologist is responsible for the supervision of all steam cleaning procedures.
2. The annular space between the well screen and the borehole wall will be filled with a uniform gravel/sand pack to serve as a filter media. For wells deeper than approximately 50 feet, or when recommended by the site geologist, the sand pack will be emplaced using a tremie pipe. A sand slurry composed of sand and potable water will be pumped through the tremie pipe into the annulus throughout the entire screened interval, and over the top of the screen. Allowance must be made for settlement of the sand pack.
3. The depth of the top of the sand will be determined using the tremie pipe and a weighted measuring tape, thus verifying the thickness of the sand pack. Additional sand shall be added to bring the top of the sand pack to approximately 2 to 3 feet above the top of the well screen.

Under no circumstances should the sand pack extend into any aquifer other than the one to be monitored. In most cases, the well design can be modified to allow for a sufficient sand pack without threat of crossflow between producing zones through the sand pack.

4. For materials that will not maintain an open borehole using hollow-stem augers, the temporary or outer casing will be withdrawn gradually during placement of sand pack/grout. For example, after filling two feet with sand pack, the outer casing should be withdrawn 2 feet. This step of placing more sand and withdrawing the outer casing should be repeated until the level of the sand pack is approximately 3 feet above the top of the well screen. This ensures there is no locking of the permanent (inner) casing within the outer casing.



# STANDARD OPERATING PROCEDURES

SOP: 2048  
PAGE: 10 of 16  
REV: 0.0  
DATE: 07/12/01

## MONITOR WELL INSTALLATION

---

5. A bentonite seal of a minimum 2-foot vertical thickness will be placed in the annular space above the sand pack to separate the sand pack from the cement surface seal. The bentonite will be placed through a tremie pipe or poured directly into the annular space, depending upon the depth and site conditions. The bentonite will be pourable pellets. The geologist/hydrogeologist will record the start and stop times of the bentonite seal emplacement, the interval of the seal, the amount of bentonite used, and any problems that arise. The type of bentonite and the supplier will also be recorded.

A cap placed over the top of the well casing, before pouring the bentonite pellets, will prevent pellets from entering the well casing.

6. If a slurry of bentonite is used as an annular seal, it is prepared by mixing powdered or granular bentonite with potable water. The slurry must be of sufficiently high specific gravity and viscosity to prevent its displacement by the grout to be emplaced above it. As a precaution (regardless of depth) and depending on fluid viscosity, a few handfuls of bentonite pellets may be added to solidify the bentonite slurry surface.
7. Cement and/or bentonite grout is placed from the top of the bentonite seal to the ground surface.

Only Type I or II cement without accelerator additives may be used. An approved source of potable water must be used for mixing grout materials. The following mixes are acceptable:

- Neat cement, a maximum of 6 gallons of water per 94 pound bag of cement
  - Granular bentonite, 1.5 pounds of bentonite per 1 gallon of water
  - Cement-bentonite, 5 pounds of pure bentonite per 94 pound bag of cement with 7-8 gallons of water.
  - Cement-bentonite, 6 to 8 pounds of pure bentonite per 94 pound bag of cement with 8-10 gallons of water, if water mixed
  - Non-expandable cement, mixed at 7.5 gallons of water to one half ( $\frac{1}{2}$ ) teaspoon of Aluminum Hydroxide, 94 pounds of cement (Type I) and 4 pounds of bentonite
  - Non-expandable cement, mixed at 7 gallons of water to one half ( $\frac{1}{2}$ ) teaspoon of Aluminum Hydroxide, and 94 pounds of cement (Type I and Type II)
8. Grout is pumped through a tremie pipe (normally a 1.25-inch PVC or steel pipe) to the bottom of the annulus until undiluted grout flows from the annulus at the ground surface.
  9. In materials that will not maintain an open hole, the temporary steel casing should be withdrawn in a manner that prevents the level of grout from dropping below the bottom of the casing.
  10. Additional grout may be added to compensate for the removal of the temporary



# STANDARD OPERATING PROCEDURES

SOP: 2048  
PAGE: 11 of 16  
REV: 0.0  
DATE: 07/12/01

## MONITOR WELL INSTALLATION

---

casing and the tremie pipe to ensure that the top of the grout is at or above ground surface. After the grout has set (about 24 hours), any depression due to settlement is filled with a grout mix similar to that described above.

11. The protective casing should now be set. The casing may be a 5 foot minimum length of black iron or galvanized pipe extending about 1.5 to 3 feet above the ground surface, and set in concrete or cement grout. The protective casing diameter should be at least 2 inches greater than the well casing. A 0.5-inch drain hole may be installed near ground level. A flush-mount protective casing may also be used in areas of high traffic or where access to other areas would be limited by a well stick-up.
12. A protective steel cap, secured to the protective casing by a padlock, should be installed.
13. Steel guard posts should be installed around the protective casing in areas where vehicle traffic may be a problem. Posts should have a minimum diameter of 3 inches and be a minimum of 4 feet high.
14. All monitor wells should be labeled and dated with paint or steel tags.

### 7.4 Well Development

Well development is the process by which the aquifer's hydraulic conductivity is restored by removing drilling fluids, and fine-grained formation material from newly installed wells. Two methods of well development that are commonly used are surging and bailing, and overpumping. A well is considered developed when the pH and conductivity of the groundwater stabilizes and the measured turbidity is <50 nephelometric turbidity units (NTUs).

Surging and bailing will be performed as follows:

1. Measure the total depth (TD) of the well and depth to water (DTW).
2. Using an appropriately sized surge block, surge 5-foot sections of well screen, using 10-20 up/down cycles per section. Periodically remove the surge block and bail accumulated sediment from the well, as required.
3. For open-hole wells, a 6-inch surge block will be used inside the cased portion of the well. Sediments will be bailed periodically, as required. Overpumping may be used in combination with surging and bailing for development of bedrock wells. The method(s) used will be based on field conditions encountered, and will be determined by the site geologist/hydrogeologist. However, sediment will initially be removed from the wells by bailing in order to minimize the volume of development water generated.

The pump used must be rated to achieve the desired yield at a given depth. The pump system should include the following:



# STANDARD OPERATING PROCEDURES

SOP: 2048  
PAGE: 12 of 16  
REV: 0.0  
DATE: 07/12/01

## MONITOR WELL INSTALLATION

---

- A check valve to prevent water from running back into the well when the pump is shut off
- Flexible discharge hose
- Safety cable or rope to remove the pump from the well
- Flow meter (measuring bucket or inline flow meter)
- Generator
- Amp meter, to measure electrical current (load)

The amp meter is used to monitor pump performance. If the pump becomes clogged, the amperage will increase due to stress on the pump. If the water level drops below the intake ports, the current will drop due to decreased resistance on the pump.

### 8.0 CALCULATIONS

To maintain an open borehole during rotary drilling, the drilling fluid must exert a pressure greater than the formation pore pressure. Typical pore pressures for unconfined and confined aquifers are 0.433 pounds per square inch per foot (psi/ft) and 0.465 psi/ft, respectively.

The relationship for determining the hydrostatic pressure of the drilling fluid is:

$$\text{Hydrostatic Pressure (psi)} = \text{Fluid Density (lb/gal)} \times \text{Height of Fluid Column (ft)} \times 0.052$$

The minimum grout volume necessary to grout a well can be calculated using:

$$\text{grout Vol. (ft}^3\text{)} = \text{Vol. of Borehole (ft}^3\text{)} - \text{Vol. of Casing (ft}^3\text{)} = L(r^2B - r^2C)$$

where:

$L$  = length of borehole to be grouted (ft)

$r_B$  = radius of boring (ft)

$r_C$  = radius of casing (ft)

### 9.0 QUALITY ASSURANCE/QUALITY CONTROL

There are no specific quality assurance activities that apply to the implementation of these procedures. However, the following general QA procedures apply:

1. All data must be documented on standard well completion forms, field data sheets or within field/site logbooks.
2. All instrumentation must be operated in accordance with the operating instructions as provided by the manufacturer, unless otherwise specified in the work plan. Equipment checkout and calibration activities must occur prior to sampling/operation and must be documented.

### 10.0 DATA VALIDATION

This section is not applicable to this SOP.

### 11.0 HEALTH AND SAFETY



# STANDARD OPERATING PROCEDURES

SOP: 2048  
PAGE: 13 of 16  
REV: 0.0  
DATE: 07/12/01

## MONITOR WELL INSTALLATION

---

Drilling rigs and equipment present a variety of safety hazards. All personnel working around drilling rigs should know the position of the emergency "kill" switch. Wirelines and ropes should be inspected and frayed or damaged sections discarded. Swivels and blocks should turn freely. Gauges should be operational and controls clearly marked. All underground utilities should be clearly marked, and drillers should be aware of any overhead hazards such as power lines. Avoid drilling in these areas. Ear protection should be worn when working around drilling equipment for extended periods of time, particularly air rotary equipment. Failure to follow safety procedures or wear the proper personal protection gear, on the part of either the drilling crew or SERAS personnel, may result in dismissal from the job.

When working with potentially hazardous materials, follow U.S. EPA, Occupational Safety and Health Administration (OSHA), and corporate health and safety practices.

### 12.0 REFERENCES

American Society for Testing and Materials. 1991. Annual Book of ASTM Standards. Designation: D5092-90. *Standard Practice for Design and Installation of Groundwater Monitoring Wells in Aquifers*. Philadelphia, PA. p. 1081-1092.

Boateng, K., P.C. Evens, and S.M. Testa. 1984. "Groundwater Contamination of Two Production Wells: A Case History." *Groundwater Monitoring Review*, 4(2):24-31.

Keely, J.F. and Kwasi Boateng. 1987. "Monitoring Well Installation, Purging, and Sampling Techniques - Part 1: Conceptualizations." *Groundwater* 25(3):300-313.

Keely, J.F. and Kwasi Boateng. 1987. "Monitoring Well Installation, Purging, and Sampling Techniques - Part 2: Case Histories." *Groundwater* 25(4):427-439.

Driscoll, F.G. 1986. *Groundwater and Wells*. 2<sup>nd</sup> ed. Johnson Division, UOP Inc., St. Paul, MN. p. 1089

U.S. Environmental Protection Agency. 1987. *A Compendium of Superfund Field Operations Methods*. EPA/540/P-87/001. Office of Emergency and Remedial Response. Washington, DC.

American Society for Testing and Materials. 1991. Annual Book of ASTM Standards. Designation: D1586-84. *Split Barrel Sampling*. Philadelphia, PA.

### 13.0 APPENDICES

A - Figures



# STANDARD OPERATING PROCEDURES

SOP: 2048  
PAGE: 14 of 16  
REV: 0.0  
DATE: 07/12/01

## MONITOR WELL INSTALLATION

---

APPENDIX A

Figures

SOP #2048

July 2001



# STANDARD OPERATING PROCEDURES

SOP: 2048  
PAGE: 15 of 16  
REV: 0.0  
DATE: 07/12/01

## MONITOR WELL INSTALLATION

FIGURE 1. Typical Bedrock Well Construction

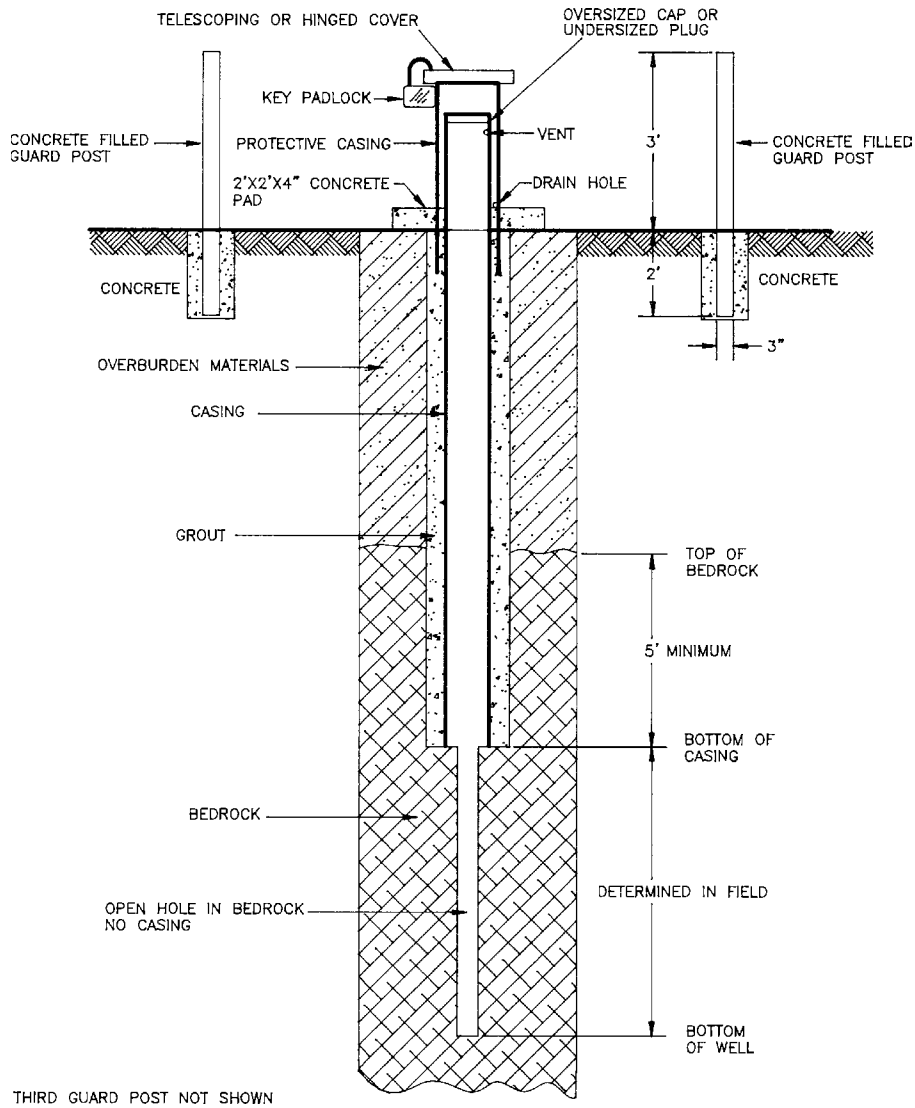



# STANDARD OPERATING PROCEDURES

SOP: 2048  
PAGE: 16 of 16  
REV: 0.0  
DATE: 07/12/01

## MONITOR WELL INSTALLATION

FIGURE 2. Typical Overburden Well Construction

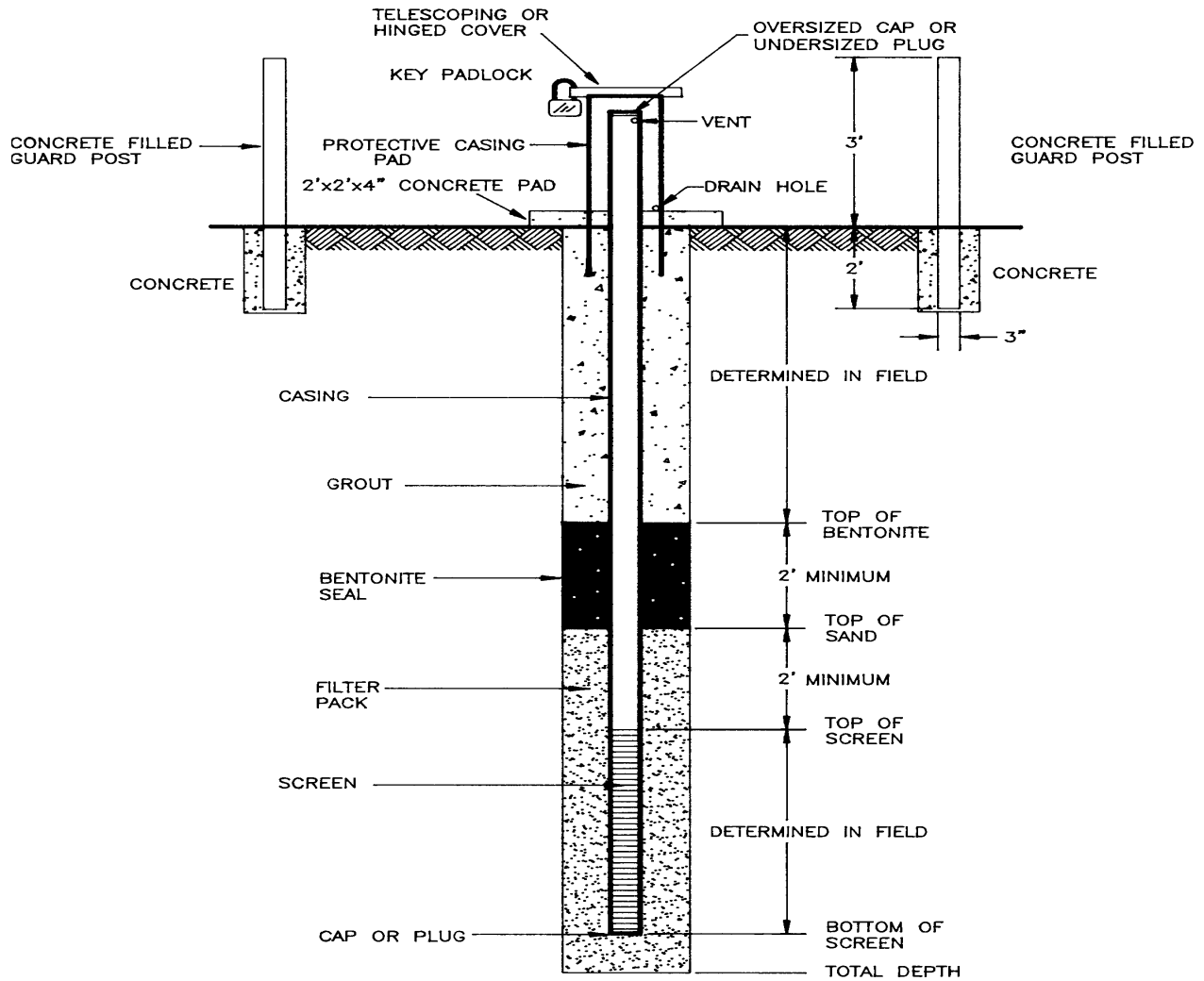



## **Appendix B: Standard Operating Procedures / Quality Assurance Plan for Groundwater Monitoring**

Pinto Valley Mining Corp.

**Table B1 Suite A Groundwater Quarterly Analytes**

Parameters (mg/L, unless noted)	Minimum Detection Limit (mg/L, unless noted)	Preservative	Container	Preparation	Holding Times	Method
Depth to Water (ft bgs)	NA	NA	NA	NA	NA	Sounder
pH (field) (SU)	NNS				15 minutes	Meter
Temperature, Water (field) (°C)	NNS				15 minutes	
Specific Conductance (field) (µS/cm)	NNS				15 minutes	
TDS	500 <sup>1</sup>	cool to < 4° C	500 mL plastic (or glass)	NA	7 days	SM 2540 C
Fluoride	4.0				28 days	EPA 300.0
Sulfate	250 <sup>1</sup>				28 days	EPA 300.0
Antimony, Dissolved	0.006	HNO3 to pH <2, cool to < 4° C	500 mL plastic (or glass)	Field filter	6 months	EPA 200.8
Arsenic, Dissolved	0.05					EPA 200.7
Beryllium, Dissolved	0.004					EPA 200.7
Cadmium, Dissolved	0.005					EPA 200.8
Cobalt, Dissolved	NA					EPA 200.7
Copper, Dissolved	NA					EPA 200.7
Iron, Dissolved	NA					EPA 200.7
Lead, Dissolved	0.05					EPA 200.8
Manganese, Dissolved	NA					EPA 200.7
Nickel, Dissolved	0.1					EPA 200.7
Selenium, Dissolved	0.05					EPA 200.8
Zinc, Dissolved	NA					EPA 200.7
Nitrate + Nitrite, as N	10	H2SO4 to pH <2, cool to < 4° C	250 mL plastic	NA	28 days	EPA 353.2

Notes:  
 ft bgs = feet below ground surface.  
 NA = not applicable; SU = standard units; NNS = no numerical standard.  
<sup>1</sup> Based on reference EPA National Secondary Drinking Water Standard  
 ° C = degrees Celsius

**Table B2 Suite B Groundwater Biennial Analytes**

Parameters (mg/L, unless noted)	Minimum Detection Limit (mg/L, unless noted)	Preservative	Container	Preparation	Method	Holding Times
Depth to Water (ft bgs)	NA	NA	NA	NA	Sounder	NA
pH (field) (SU)	NNS				Meter	15 minutes
Temperature, Water (field) (°C)	NNS					
Specific Conductance (field) (µS/cm)	NNS					
pH (lab) (SU)	NNS	cool to < 4° C	500 mL plastic (or glass)	NA	SM 4500 H B	immediate
Specific Conductance (lab) (µS/cm)	NNS				EPA 120.a	28 days
Chloride	NNS				EPA 300.0	28 days
Fluoride	4.0				EPA 300.0	28 days
Sulfate	250 <sup>3</sup>				EPA 300.0	28 days
Cation Anion Balance (% Difference)	NNS				Calculation	NA
Alkalinity, Total as CaCO <sub>3</sub>	NNS				SM 2320B	14 days
Alkalinity, Carbonate as CaCO <sub>3</sub>	NNS				SM 2320B	14 days
Alkalinity, Bicarbonate as CaCO <sub>3</sub>	NNS				SM 2320B	14 days
Calcium, Dissolved	NNS				HNO <sub>3</sub> to pH <2, cool to < 4° C	500 mL plastic (or glass)
Magnesium, Dissolved	NNS	EPA 200.7				
Potassium, Dissolved	NNS	EPA 200.7				
Sodium, Dissolved	NNS	EPA 200.7				
Aluminum, Dissolved	NA	EPA 200.7				
Barium, Dissolved	2	EPA 200.8				

**Table B2 Suite B Groundwater Biennial Analytes (Continued)**

Parameters (mg/L, unless noted)	Minimum Detection Limit (mg/L, unless noted)	Preservative	Container	Preparation	Method	Holding Times
Mercury, Dissolved	0.002				EPA 245.1	28 days
Thallium, Dissolved	0.002				EPA 200.8	6 months
Chromium, Total	0.1				500 mL plastic (or glass)	NA
Cyanide, Total	NNS	NaOH to pH $\geq$ 12, cool to $< 4^{\circ}$ C	1 L plastic (or glass)	NA	EPA 335.4	14 days
Nitrate + Nitrite, as N	10	H <sub>2</sub> SO <sub>4</sub> to pH $< 2$ , cool to $< 4^{\circ}$ C	250 mL plastic	NA	EPA 353.2	28 days
Gross Adjusted Alpha 6 (pCi/L)	NNS	NA	NA	NA	Calculation <sup>1</sup>	NA
Gross Alpha, Dissolved (pCi/L)	15	HNO <sub>3</sub> to pH $< 2$ , cool to $< 4^{\circ}$ C	3 1-Liter plastic (or glass)	NA	EPA 900 <sup>2</sup>	6 months
Radium 226+228 (pCi/L)	5.0			NA	EPA 903/904	6 months
Uranium (combined) pCi/L	NNS			NA	U-02-RC	6 months

## Notes:

AWQL = aquifer water quality standard; SDWS = secondary drinking water standards; ft bgs = feet below ground surface; NA = not applicable; SU = standard units; NNS = no numerical standard; pCi/L = picocuries per liter

<sup>1</sup> adjusted gross alpha particle activity is the gross alpha particle activity, including radium-226 and any other alpha emitters, if present, minus radon and total uranium; use method EPA 900.0; calculation formula: laboratory reported gross alpha MINUS sum of uranium isotopes

<sup>2</sup> 15 pCi/L is for gross alpha particle activity including Radium-226 but excluding radon and uranium

<sup>3</sup> Based on reference EPA National Secondary Drinking Water Standard

$^{\circ}$  C = degrees Celsius

**Appendix B 1 Arizona Aquifer Protection Permit  
Quality Assurance Plan (QAP)**

Pinto Valley Mining Corp., July 2019

**PINTO VALLEY MINE**

**Arizona Aquifer Protection Permit**

**Quality Assurance Plan (QAP)**

July 2019



Pinto Valley Mine  
Pinto Valley Mining Corp.  
2911 N. Forest Service Road 287  
P.O. Box 100  
Miami, AZ 85539-0100

# Table of Contents

<b>1.0</b>	<b>PLAN OBJECTIVE AND DESCRIPTION</b>	<b>1</b>
1.1	PLAN OBJECTIVE	1
1.2	PLAN DESCRIPTION	1
<b>2.0</b>	<b>PROJECT MANAGEMENT</b>	<b>2</b>
2.1	PROJECT SUMMARY	2
2.2	PROJECT MANAGER RESPONSIBILITIES	2
2.3	LEAD FIELD SAMPLER RESPONSIBILITIES	3
2.4	TRAINING REQUIREMENTS	3
2.5	HEALTH AND SAFETY PLAN	4
<b>3.0</b>	<b>PROJECT DATA QUALITY OBJECTIVES (DQOS)</b>	<b>4</b>
3.1	LABORATORY REPORTING LIMITS	4
3.2	ACCURACY AND PRECISION	5
3.2.1	DUPLICATES, FIELD BLANKS, AND TRIP BLANKS	5
3.2.2	METHOD BLANKS	6
3.2.3	MATRIX SPIKES/MATRIX SPIKE DUPLICATES	6
3.2.4	LABORATORY DUPLICATES	6
3.3	COMPLETENESS	6
3.4	HOLDING TIMES	7
3.5	CATION/ANION BALANCE	7
3.6	DATA EVALUATION	8
<b>4.0</b>	<b>APP REQUIRED SAMPLING</b>	<b>9</b>
4.1	SAMPLE LOCATIONS	9
4.2	SAMPLE FREQUENCY	10
4.3	REQUIRED ANALYTICAL PARAMETERS	10
4.3.1	QUARTERLY MONITORING PARAMETERS	10
4.3.2	BIENNIAL MONITORING PARAMETERS	10
<b>5.0</b>	<b>WATER SAMPLE COLLECTION PROCEDURES</b>	<b>11</b>
5.1	GENERAL WATER SAMPLING PROCEDURES	11
5.1.1	MEASUREMENT OF FIELD INDICATORS PARAMETERS	13
5.1.2	FIELD FILTRATION	14
5.1.3	COLLECTION OF VOLATILE ORGANIC COMPOUNDS (VOCS)	14

5.1.4	LABORATORY REPORTING LIMITS.....	14
5.1.5	PROPER FILLING OF SAMPLE BOTTLES .....	14
5.1.6	SAMPLE HANDLING AND TRANSPORTATION.....	15
5.1.7	SAMPLE HOLDING TIMES .....	15
5.1.8	DOCUMENTATION.....	16
5.2	FIELD QC REQUIREMENTS.....	16
5.2.1	DUPLICATES, EQUIPMENT BLANKS, AND TRIP BLANKS .....	16
5.3	EQUIPMENT CLEANING/DECONTAMINATION PROCEDURES.....	17
5.4	INSTRUMENT TESTING AND CALIBRATION PROCEDURES .....	18
5.5	GROUNDWATER SAMPLING PROCEDURES .....	18
5.5.1	PURGING.....	19
5.6	SPRING WATER SAMPLING & FLOW MEASUREMENT PROCEDURES...	20
<b>6.0</b>	<b>REFERENCES .....</b>	<b>22</b>



# Tables

- Table 3-1** PVM Monitoring Staff
- Table 4-1** Measurement Performance Criteria for Water Samples
- Table 5-1** APP POC Wells
- Table 5-2** APP POC Springs
- Table 5-3** APP Alert Level Monitoring Points

# Appendices

- Appendix A** APP Quarterly Monitoring Tables
  - Table A-1 Points of Compliance Quarterly Analyte List
  - Table A-2 Sample Container Type, Required Preservatives, and Holding Times
  - Table A-3 Applicable Water Quality Standards and Acceptable/Maximum Laboratory Reporting Limits
  
- Appendix B** APP Biennial Monitoring Tables
  - Table B-1 Points of Compliance Biennial Analyte List
  - Table B-2 Sample Container Type, Required Preservatives, and Holding Times
  - Table B-3 Applicable Water Quality Standards and Acceptable/Maximum Laboratory Reporting Limits
  
- Appendix C** Standard Operating Procedures for Calibration of Field Water Quality Meter

# Revision Log

<i>Revision Number</i>	<i>Revision Lead</i>	<i>Purpose of Revision</i>	<i>Revision Date</i>

## **1.0 PLAN OBJECTIVE AND DESCRIPTION**

The purpose of this *Quality Assurance Plan* (QAP) is to describe water sample collection and analyses procedures as required under the Pinto Valley Mine Aquifer Protection Permit (APP) No. P-100329. Use of this QAP will ensure that the data collected and analyzed meets specific project and permit requirements. This QAP is designed and organized to provide guidance for company personnel as well as contractors.

This QAP will be kept at the Pinto Valley Mine (PVM) site for review, upon request, by the Arizona Department of Environmental Quality (ADEQ), Arizona Department of Health Services (ADHS), U.S. Environmental Protection Agency (USEPA), U.S. Forest Service (USFS), and other regulatory agencies. This QAP will be updated and revised as needed.

Pinto Valley Mining Corp. owns and operates PVM – an open pit copper and molybdenum mine, low-grade ore leaching operation, mill/concentrator, and a solution extraction-electrowinning (SX-EW) plant. Pinto Valley Mining Corp. is the sole owner and operator of the mine, and a wholly-owned, indirect subsidiary of Capstone Mining Corp. Pinto Valley Mining Corp. is responsible for compliance with all permit requirements and conditions.

### **1.1 PLAN OBJECTIVE**

The objectives of this QAP are to provide:

- Guidance on water sample collection procedures to ensure that a sample or group of samples accurately characterizes given conditions;
- Consistency in water quality sampling efforts, including the documentation of those samples. Standardizing the various water quality sample collection efforts will ensure that consistent, accurate, and defensible analyses are obtained; and
- Assure accurate, precise, comparable, and complete data.

The collected water quality, water level, and spring flow data will be collected for compliance with the PVM APP. Collected data will also be used to:

- Support various regulatory programs, which include the ADEQ's APP and Arizona Pollutant Discharge Elimination System (AZPDES) programs;
- Assess water quality compared to defined guidelines and standards;
- Understand the overall groundwater system at the Pinto Valley Mine and in the surrounding areas;
- Assess and compare water quality and groundwater levels during operational, closure, and post-closure;
- Update and re-calibrate the groundwater flow and pit lake models, and
- Identify potential contaminant sources.

### **1.2 PLAN DESCRIPTION**

The remainder of this document includes the following sections:

- Section 2.0 – Certification Page
- Section 3.0 – Project Management
- Section 4.0 – Project Data Quality Objectives (DQOs)
- Section 5.0 – APP Required Sampling
- Section 6.0 – Water Sample Collection Procedures
- Section 7.0 – References

## 2.0 PROJECT MANAGEMENT

### 2.1 PROJECT SUMMARY

The organizational structure of the Pinto Valley Mine APP program is provided below.

Pinto Valley Mine staff are responsible for the collection, shipping, validation, compilation, and evaluation of the data obtained for the APP program. The following table provides the names and responsibilities of the staff that will perform oversight, management, data review, data evaluation, sample collection, and/or other related monitoring tasks. The Project Manager is the primary contact for all staff involved with the water monitoring programs.

**Table 3-1 – PVM Monitoring Staff**

Person	Position	Phone Number
Kim Furphy	Environmental Superintendent / Project Manager	928-473-6456
Todd Town	Lead Field Sampler	928-812-0875
Lawrence Williams Sam Bell	Field Samplers / Equipment Calibration	NA
Suzanne McRae	Database Technician	928-473-6317

### 2.2 PROJECT MANAGER RESPONSIBILITIES

The Project Manager is responsible for general Project supervision and review of the activities of the Field Sampling staff. The Project Manager will:

- Oversee Quality Assurance/Quality Control (QA/QC) functions through monitoring activities;
- Inform field personnel of the QC practices to be employed during field work;
- Approve corrective actions for the field and office data management;
- Ensure that data meet Project-specific objectives;

- Review data quality assessment results and approve database summary reports;
- Assure this QAP is reviewed and updated as needed, and in accordance with the APP, and distribute any modifications to appropriate parties;
- Review and approve all QA/QC documents pertaining to site monitoring activities;
- Ensure that proper sample custody procedures are followed;
- Review chain-of-custody records and sample transmittal documents for completeness;
- Ensure that appropriate field measurement data and analytical laboratory data are entered, stored, maintained, and backed-up in an electronic database management system (delegated to the Database Technician);
- Verify the quality of data and review analytical results with Project personnel;
- Perform, or direct the performance of, field procedure audits;
- Maintain data quality and audits;
- Monitor progress in correcting laboratory deficiencies, and
- Act as Pinto Valley Mine's liaison to ADEQ, ADHS, USEPA, USFS, and other environmental regulatory agencies.

### **2.3 LEAD FIELD SAMPLER RESPONSIBILITIES**

The Lead Field Sampler (QA Manager) is responsible for overseeing all field activities; assignment of field personnel of the QC practices to be employed during field work and performing and overseeing QA/QC functions throughout monitoring activities. The Lead Field Sampler will:

- Coordinate all sampling efforts with field personnel and the Project Manager;
- Ensure that all field supplies and equipment, including sampling equipment, bottles, labels, custody seals, preservatives, and shipping supplies necessary to properly sample groundwater, seeps, springs, stormwater, and/or surface water, are available and in good condition;
- Maintain a record of all samples submitted to the laboratories for analysis, the analyses requested, and the final results;
- Ensure that field personnel adhere to the procedures and SOP's documented in this QAP unless field conditions require modifications;
- Review field notebooks and ensure that all appropriate field data forms are complete and correct, and
- Coordinate corrective actions, as necessary, for all field activities.

### **2.4 TRAINING REQUIREMENTS**

All PVM-designated field samplers are qualified to perform the monitoring described in this QAP based on a combination of education, training, and experience. Education and experience constitute the primary means of qualification. Training may be assigned and

provided by the Project Manager for specific projects and/or employees. Qualifications and training records will be maintained at the PVM office.

## **2.5 HEALTH AND SAFETY PLAN**

There are many hazards to be aware of when working in the field. All Project staff, and contracted consultants, working on the Project site will follow the health and safety policies set forth in PVM safety procedures.

## **3.0 PROJECT DATA QUALITY OBJECTIVES (DQOS)**

The Data Quality Objectives (DQOs) for the Pinto Valley Mine APP program include: 1) ensuring consistency in water quality sampling efforts, including the documentation of those samples collected, and 2) acquiring valid, accurate, and legally-defensible analytical data (i.e., accurate, precise, comparable, and complete data). The following field and laboratory procedures have been established to achieve these objectives:

- Use of appropriate laboratory reporting limits;
- Collection of field duplicate samples and equipment blanks;
- Evaluation of laboratory method blank data;
- Evaluation of Matrix Spike/Matrix Spike Duplicate laboratory data;
- Evaluation of data completeness;
- Evaluation of sample holding times; and
- Verification of cation/anion balance in water samples.

### **3.1 LABORATORY REPORTING LIMITS**

The laboratory reporting limit (RL) is a laboratory-specific number and defined as the lowest concentration at which an analyte can be detected in a sample and its concentration can be reported with a reasonable degree of accuracy and precision. A criterion of a  $\pm 20\%$  accuracy, and 20% relative standard deviation (RSD) for replicate determinations, is often used to define “reasonable”. The acceptable ranges depend somewhat on the analytical methodology used. For samples that do not pose a particular matrix problem, the RL is typically about three to five times higher than the method detection limit (MDL).

When possible (i.e., no interference), the laboratory RL value for each and every parameter analyzed in the APP water samples must be equal to or below (preferably below) the applicable and relevant numeric water quality standard as promulgated, revised, and published by ADEQ. Water quality standards include:

- Arizona Aquifer Water Quality Standards (AWQS), Arizona Administrative Code (A.A.C.) R18-11-406; and
- Arizona Surface Water Quality Standards (SWQS), Appendix A of A.A.C. Title 18, Chapter 11, Article 1.

Tables A-3 and B-3 in Appendices A and B of this Plan provide acceptable/maximum laboratory RLs for each of the required APP quarterly and biennial water sampling parameters.

## 3.2 ACCURACY AND PRECISION

Accuracy is an assessment of the closeness of the measured value to the true (or expected) value. Accuracy for field measurements are determined as follows:

Known pH buffers and specific conductance standards are used to calibrate and determine the accuracy of the field water quality meter. Accuracy of a laboratory analysis is assessed by analyzing a sample “spiked” with a known concentration and establishing the average recovery. For water programs conducted under this QAP, accuracy for the analytical measurement of spiked samples must be at least 80 percent (80%).

Precision of the data is a measure of the data spread when more than one measurement has been taken on the same sample (or sampling location) under identical, or substantially similar, conditions. Precision is calculated for field and laboratory measurements through sample duplicates and measurement replicates. Duplicate precision is typically analyzed by calculating the relative percent difference (RPD). The formula to calculate RPD is:

$$RPD = 100 \times (S - D) / [(S + D) / 2]$$

where S = original sample result, D = duplicate sample result

For water programs conducted under this QAP, RPDs less than 20% will be deemed acceptable for field and laboratory duplicates.

### 3.2.1 Duplicates, Field Blanks, and Trip Blanks

USEPA field sampling guidance recommends collecting and submitting QC control samples (i.e., field blanks, duplicates, etc.) along with the routine samples at a frequency of one (1) for every ten (10) samples (USEPA, 2004).

Field duplicates are two (2) identical samples collected at the same time from the same source, but placed in separate sample containers with separate sample identification numbers (IDs). The purpose of collecting a duplicate is to assess field/sampling procedures and laboratory handling and analytical procedures.

Field equipment blanks are used when sampling equipment is decontaminated and reused in the field (i.e. submersible pump) or when a sample collection vessel will be used. The purpose of the field blank is to check for potential contamination that may be due to sampling equipment, cross contamination from previously-collected samples, or contamination from condition during sampling.

Field equipment blanks should be free of contamination to ensure that the decontamination procedures conducted are effective. If contaminants are seen in field equipment blank samples, decontamination and handling procedures will be reviewed and revised, if necessary.

In the event that a water sample is required to be analyzed for volatile organic compounds (VOCs), a trip blank will be included with the water samples. A trip blank is only used for VOC analyses. Trip blanks are provided by the analytical laboratory. Results from the trip blanks should be free of contamination. If contaminants are seen in trip blank samples, container handling and storage procedures should be re-examined and adjusted.

The data quality objective for duplicate sample results is to obtain a RPD of 20% or less between the original sample and the duplicate sample. If the results consistently differ by

more than 20%, and the field/sampling procedures were consistent, then the precision of the analytical laboratory is unacceptable, assuming that the sample matrix is uniform and homogenous.

Section 6.2.1 of this QAP discusses the specific sample collection and transportation procedures for field duplicates, equipment blanks, and trip blanks.

### **3.2.2 Method Blanks**

For each batch of samples submitted, the analytical laboratory should run a set of method blanks (also called control blanks) to determine the level of contamination associated with laboratory reagents and glassware. Method blanks are prepared by the laboratory by analysis of laboratory reagent or blank water. Method blanks are an aliquot of analyte-free water that is put through all the steps of a specific method along with the samples. Results of the method blank analysis should be reported with the sample results. Method blanks should be free of contamination to ensure cross-contamination of the samples has not occurred in the laboratory.

### **3.2.3 Matrix Spikes/Matrix Spike Duplicates**

Matrix spikes (MS) and matrix spike duplicates (MSD) analyses are used to assess the accuracy (MS) and precision (MSD) of the analytical methods in a sample matrix. The analytical laboratory prepares matrix spike samples by splitting off three aliquots of the water sample and adding known amounts of target analytes to two of the three sample aliquots.

The results of the analysis of the unspiked water sample are compared to the MS analysis results, and “percent recovery” of each spike is calculated to determine the accuracy of the analysis. The acceptance criteria is usually specified by the analytical method. If the results for the MS fall outside of the acceptable range it will be flagged by the laboratory as a qualifier. Recoveries outside of acceptable criteria indicate a problem with the analytical laboratory that should be resolved with the laboratory prior to finalizing the data report.

The RPD of the MS and the MSD is a measure of the precision of the analytical method. These results should be within +20%. If they are not, discrepancies should be resolved with the analytical laboratory.

### **3.2.4 Laboratory Duplicates**

Laboratory duplicates are a second aliquot of a sample treated exactly the same way through preparation and analysis. Calculating the RPD between the original sample results and the sample duplicate is another measure of the precision of the analytical method. The acceptance criteria for the RPD is usually +20%, assuming the sample result is at least 5 times greater than the reporting limit. Otherwise, it is not a valid comparison.

## **3.3 COMPLETENESS**

Completeness is the comparison between the amount of data planned to be collected versus the amount of usable data actually collected, expressed as a percentage. The target completeness objective is 90 percent; the actual completeness may vary depending on the intrinsic nature of the samples. A completeness value of less than 90 percent indicates that



corrective action is necessary to limit the number of incomplete or unacceptable results and to avoid similar problems in future sampling events.

Criteria for incomplete or unacceptable results may include sample containers lost or broken during sample shipment or at the laboratory, and data qualified as unusable during data verification procedures.

The completeness of the monitoring data will be assessed during the data validation process as discussed in Section 4-1 below.

**Table 4-1 - Measurement Performance Criteria for Water Samples**

<b>Data Quality Indicators</b>	<b>Measurement Performance Criteria</b>	<b>QC Sample and/or Activity Used to Assess Measurement Performance</b>
Precision – in the field	+/- 20% RPD	Field duplicates
Precision – lab	+/- 20% RPD	Laboratory duplicates
Accuracy / bias	Recovery: 80% - 120% ; 1 every 10 samples	Laboratory spikes/ duplicates (MS/MSD sets)
Representativeness	Determine compliance with applicable water quality standards or other permit conditions	Obtain representative samples
Comparability	Use standardize sampling procedures	Data comparability check
Data completeness	≥ 90% samples collected	Data Completeness check
Field contamination	< or = to reporting detection limit	Field blank
Lab contamination	< or = to reporting detection limit	Lab blank

### **3.4 HOLDING TIMES**

Each parameter to be analyzed in a water sample has a specific hold time, determined by the analytical method, that ensures the results generated are accurate. If the designated maximum hold time (i.e. hours or days) has passed, the data generated through analysis should not be used since its accuracy cannot be confirmed. Therefore, the laboratory must receive the water samples before exceeding the maximum holding time for the parameter to be analyzed, allowing enough time with the holding time for the laboratory to process the sample.

Holding times are provided in Tables A-2 and B-2 in Appendices A and B of this QAP. Samples submitted to the laboratory after the holding time has expired will be analyzed only under direct request from the Project Manager. Appropriate sample and/or data qualifiers should be noted on the final laboratory analytical report.

### **3.5 CATION/ANION BALANCE**

Another useful QA method for determining the reliability of a water sample analysis is the measurement of the cation-anion balance. Tables 4.2-4 and 4.2-5 of the APP require that a cation/anion balance be calculated every two years (biennially) at each of the Point of Compliance (POC) monitoring points. The cation/anion balance calculation assumes that major ions comprise most of the total dissolved solids in a water sample, and requires that all major ion concentrations be measured. In an accurate analysis, the sum of the

milliequivalents of major cations (Na, K, Ca, Mg) and anions (HCO<sub>3</sub>, Cl, SO<sub>4</sub>, possibly NO<sub>3</sub>) should be equal. The average difference should not exceed 15%. Factors that can affect cation/anion balance include laboratory error; high suspended solids (“interference”), species not included in the calculation (i.e. F, soluble Fe), or samples analyzed from a preserved bottle.

An ion balance will be conducted on all water samples collected during the biennial sampling event as a component of the data validation process.

It should be noted that, in order to calculate the ion balance, additional constituents (other than those required by the APP) must be analyzed. These constituents include: fluoride, sulfate, and nitrate-nitrite analyses. The chain-of-custody form should indicate this for each water sample submitted for the biennial sampling event.

### **3.6 DATA EVALUATION**

Upon receipt of each laboratory analytical report, the PVM Project Manager, or designee, will conduct an evaluation of the laboratory analytical results and field documentation (i.e., sample collection forms, Chain of Custody (COC) forms, field notes, etc.) related to those samples. The PVM Project Manager, or designee, will review and evaluate the laboratory and field data to determine if the data are of sufficient quality and accuracy to support the above-outlined Project DQOs. After the data review is completed, data qualifiers may be appended to the measurement values.

In the event of poor laboratory results or other errors, the Project Manager, or designee, will communicate with the analytical laboratory project manager to determine the cause of the poor results and take corrective action, if necessary (i.e., re-analyze, re-sample).

The data validation process will ensure that:

- The sampling protocols, analytical parameters, and methods outlined in this QAP were used;
- The laboratory analytical report provided the following information: sample number and laboratory identification number, analysis method type or number, detection limits, and date of analysis;
- The individual protocols specified by the USEPA or ADEQ (for the analytical methods used) were followed;
- The internal laboratory procedures, such as lab blank and surrogate analysis, were performed as follows:
  - Matrix spike analysis were performed on at least every 20<sup>th</sup> sample;
  - If less than 20 samples were collected, at least one (1) matrix spike analysis was performed;
  - The laboratory report provided the results of all internal laboratory QA/QC procedures such as lab blank, matrix spike, and surrogate analyses; and
  - The laboratory report documented any problems it encountered regarding Chain of Custody, procedures, sample holding times, sample analyses, lab contamination.

## 4.0 APP REQUIRED SAMPLING

Section 2.5.2 of the PVM APP describes the routine, or compliance, groundwater quality monitoring required for the POC monitoring points.

### 4.1 SAMPLE LOCATIONS

Compliance monitoring required by the PVM APP consists of monitoring the following sources:

- Groundwater – (APP Wells)
- Surface water – (springs and seeps)

Nine (9) groundwater monitor wells, or POC wells, are required to be monitored under the APP. Table 5-1 below lists the APP-designated POC wells.

**Table 5-1 APP POC Wells**

Identifier	ADWR Number	Latitude	Longitude	Facility Monitoring
APP-1A	55-543407	33° 27' 25" N	110° 58' 43" W	TSF4 – above fault zone
APP-1Br	55-563251	33° 27' 25" N	110° 58' 43" W	TSF4 – below fault zone
APP-2	55-543406	33° 27' 16" N	110° 59' 46" W	TSF4, Eastwater Canyon
APP-3A	55-543404	33° 25' 34" N	110° 59' 59" W	Gold Gulch
APP-3B	55-543405	33° 25' 34" N	110° 59' 59" W	Gold Gulch
APP-4	55-543403	33° 25' 21" N	111° 00' 03" W	TSF3, Whitman Draw
APP-5A	55-543402	33° 23' 42" N	110° 59' 07" W	No. 1 Seepage
APP-5B	55-553712M	33° 23' 42" N	110° 59' 07" W	No. 1 Seepage
APP-6	55-543401	33° 23' 36" N	110° 58' 57" W	Miller Gulch

ADWR # = Arizona Department of Water Resources well registration number.  
TSF = Tailings storage facility

In addition to the 9 POC wells, two (2) springs are required to be monitored as POCs in the APP. Table 5-2 below lists the springs.

**Table 5-2 APP POC Springs**

Identifier	Latitude	Longitude
North Draw 1	33° 25' 38" N	111° 00' 00" W
MG1-6b / Homestead Springs	33° 24' 54" N	111° 00' 05" W

The APP also includes three (3) Alert Level Monitoring locations (one well, one spring, and one seep).

**Table 5-3 Alert Level Monitoring Points**

Identifier	ADWR Number	Latitude	Longitude	Facility Monitoring
APP-7	55-560644	33° 22' 58" N	110° 59' 25" W	Gold Gulch
MG1-12b / Spring	N/A	33° 25' 31" N	110° 59' 43" W	Gold Gulch
MG1-7a / seep	N/A	33° 23' 33" N	110° 59' 17" W	Raffinate Pond

## 4.2 SAMPLE FREQUENCY

Routine groundwater and surface water monitoring under the APP are conducted on a quarterly and biennial basis. Sections 2.5.2.1 through 2.5.2.3 of the APP describe the monitoring requirements for the wells, springs, and seep.

In addition, and as specified in Section 2.6.2.4, if an Alert Level (AL) is exceeded at a APP monitoring point (POC or Alert Level monitoring location), additional (contingency) sampling is required. Section 2.6.2.4.2 of the APP lists the steps and time frames required to conduct contingency sampling. Alert levels have been calculated for each APP monitoring point and are listed in Tables 4.2-2 through 4.2-5 of the permit.

## 4.3 REQUIRED ANALYTICAL PARAMETERS

### 4.3.1 Quarterly Monitoring Parameters

Table 4.2-2 of the APP lists each POC well and the parameters that are required to be analyzed quarterly in each well. Table 4.2-3 of the APP lists the POC springs and Alert Monitoring Locations and the parameters that are required to be analyzed in each of these monitoring points quarterly. Quarterly analytical parameters for the POC and Alert Level monitoring points include total dissolved solids, nitrate-nitrite as N, sulfate, fluoride, various metals, and one radiochemical (gross alpha for 2 Alert Monitoring points only). The metals and gross alpha analyses are required by the APP to be analyzed as dissolved metals.

Table A-1 in Appendix A of this Plan lists the quarterly analytical parameters for the POC wells and springs and Alert Level well and springs, as well as the analytical method for each parameter. Table A-2 in Appendix A provides the container type, preservative, and holding time for each parameter and Table A-3 lists the applicable water quality standard and acceptable/maximum laboratory reporting limit for each parameter required for quarterly monitoring.

Note: as indicated in Table A-1, the parameters to be monitored in each well and spring are not all the same. Double-check the chain-of-custody form to ensure that the laboratory analyzes each water sample for the correct parameters (as specified in Tables 4.2-2 and 4.2-3 of the APP.)

### 4.3.2 Biennial Monitoring Parameters

Table 4.2-4 of the APP lists the parameters that are required to be analyzed every two years (biennially) in each POC well. Table 4.2-5 of the APP lists the parameters for the POC springs and Alert Monitoring Locations that are required to be analyzed biennially in each of these monitoring points. Biennial analytical parameters for the POC wells and springs and Alert

Level well and springs consist of most of the major anions and cations, various metals, and radiochemicals. The metals and radiochemicals analyses are required by the APP to be analyzed as dissolved metals. Table B-1 in Appendix B of this Plan lists the biennial analytical parameters for the POC wells and springs and Alert Level well and springs, as well as the analytical method for each parameter. Table B-2 in Appendix B provides the container type, preservative, and holding time for each biennial parameter and Table B-3 lists the applicable water quality standard and acceptable/maximum laboratory reporting limit for each biennial parameter.

As discussed in Section 4.5 above, a cation-anion balance is required for all monitoring points in the biennial sampling. Hence, in order to calculate the ion balance, additional parameters (other than those required by the APP) must be analyzed. These parameters should include: fluoride, sulfate, and nitrate-nitrite analyses. Although not required by the APP, total dissolved solids could be requested and analyzed in each water sample to compare to the calculated totals of cations and anions. The additional parameters of fluoride, sulfate, and nitrate-nitrite are included in Table B-1 (Appendix B). The chain-of-custody form should include these parameters for each water sample submitted for the biennial sampling event.

As indicated in Table B-2, the parameters to be monitored biennially are not the same in all wells/springs. It is important to review the list of parameters prior to field sample collection to ensure that each monitoring point is analyzed for the correct parameters.

## **5.0 WATER SAMPLE COLLECTION PROCEDURES**

This section describes the general and specific procedures, methods, and considerations to be used when collecting water quality samples for laboratory analysis and other data.

Topics discussed under this section include:

- Section 6.1 – General Water Sampling Procedures
- Section 6.2 – Field QC Requirements
- Section 6.3 – Equipment Cleaning / Decontamination Procedures
- Section 6.4 – Instrument Testing and Calibration Procedures
- Section 6.5 – Groundwater Sampling Procedures
- Section 6.6 – Spring Water Sampling and Flow Measurement Procedures
- Section 6.7 – Stormwater Sampling Procedures
- Section 6.8 – Stream Sampling and Flow Measurement Procedures

Lists of the specific monitoring parameters, analytical methods, and applicable water quality standards for the above water monitoring programs are provided in Appendices A and B of this QAP.

### **5.1 GENERAL WATER SAMPLING PROCEDURES**

Before embarking on a water quality sampling event, it is important to have all necessary supplies and equipment in working order, calibrated, and ready for use.

General sampling supplies should include, but not be limited to, the following:

- field notebook and/or field computer with appropriate software
- field data sheets
- laboratory chain-of-custody (COC) form(s)
- water quality meter (for pH, temperature, conductivity)
- water level sounder
- well keys
- map or Geoportal access
- waterproof pens
- watch
- clean, laboratory-provided sample bottles
- 500 milliliter (or more) clean, pouring beaker
- distilled water
- ice
- cooler
- plastic Ziploc bags
- scissors and/or knife
- pipe wrench
- plastic bucket
- paper towels
- disposable nitrile or latex gloves (powder free)
- Alconox, LiquiNox (or other) non-phosphate detergent
- tap water
- field radio
- camera

The development of a sampling equipment checklist will expedite the preparation process. In addition, the sampler must be familiar with the parameters to be analyzed and any associated sampling requirements. The laboratory should be contacted prior to the field sampling date so that a sufficient number of appropriately sized and preserved sample bottles are ordered and picked up/delivered. Additionally, lab personnel should be notified when bottles will be picked up and when to expect samples delivered. Clean, unused laboratory-provided sample bottles are to be used for sampling.

Field water quality meters should be calibrated the morning of, or evening prior to, sample collection. See Section 6.4 regarding calibration procedures.

Special care must be taken not to contaminate the water samples. This includes storing samples in a secure location to preclude conditions which could alter the properties of the

sample, such as at elevated temperatures. Sample containers must only be opened immediately prior to filling. Appropriate disposable, powderless gloves must be worn; a new pair must be worn each time a different location is sampled or for a different sampling event at the same location.

Equipment used to collect water samples must be appropriately cleaned and decontaminated prior to measurements or sample collection (see Section 6.3).

After collection, each sample must be labeled and sealed and then immediately placed on ice in an insulated cooler. Samples must be maintained at a temperature of 4° Celsius (or less) until they are delivered to the laboratory.

Laboratory-provided chain-of-custody forms must be completed and provided to the laboratory upon delivery of the samples. The samples should be delivered to the laboratory at the end of the day, or no later than the following morning to ensure that holding times are not exceeded.

Lists of the specific parameters to be analyzed, analytical methods, recommended container type and size, required preservation, as well as the holding times for each parameter, are provided in Appendices A and B of this QAP.

Laboratory detection and reporting limits for each parameter must be at or below the applicable water quality standard for that parameter. Tables A-3 and B-3 (Appendices A and B) provide the applicable water quality standard for each required parameter, as well as an acceptable/maximum laboratory reporting limit for the parameter.

Critical information of the field sampling work (i.e., sample locations, date/time, samplers' names, weather, etc.), as well as field water quality indicator parameters, purging details, deviations from planned sampling, and other pertinent information, must be documented in the field log book or field computer.

### **5.1.1 Measurement of Field Indicators Parameters**

Measurement of field indicator parameters must be performed in-situ or using a separate sub-sample, which is then discarded once the measurement has been made. Field measurements should never be made on the same exact water sample that is going to be submitted to an analytical laboratory for analysis.

Measurement of field indicator parameters, including pH, temperature, conductivity, and other parameters (i.e. dissolved oxygen, oxidation-reduction potential [ORP]), must be performed within 15 minutes of sample collection. Report results on the appropriate electronic field sampling form.

Turbidity is also a field indicator parameter. Turbidity is a measure of the light penetration in the sample. The turbidity of the sample depends on the size and distribution of the suspended solids. Turbidity and specific conductivity can provide estimates of the amount of suspended or dissolved solids that may be present; however, they cannot be used as replacement for the analytical tests.

Other indicator parameters that may be required by a permit include dissolved oxygen (DO) and oxidation-reduction potential (ORP or Eh). Dissolved oxygen is a measure of the quantity of oxygen present in water. Oxidation-reduction potential is a measure of the oxidizing/reducing conditions.

Document the field indicator parameter measurements, along with the date, time, and sampler(s)'s initials, on the appropriate electronic field sampling form.

### **5.1.2 Field Filtration**

Samples collected for dissolved metals analysis require that the sample be filtered using a 45-micron filter as required by USEPA (USEPA; 2004) procedures. Samples collected for dissolved metals may be filtered in the field using a peristaltic pump or in-line filter. The sample must be filtered prior to filling the sample bottle. Water samples filtered in the field must be collected in a nitric acid (HNO<sub>3</sub>)-preserved laboratory bottle. It should be noted on the sample bottle label that the sample was field-filtered.

### **5.1.3 Collection of Volatile Organic Compounds (VOCs)**

Water samples that are to be analyzed for volatile organic compounds (VOCs), which includes Total Petroleum Hydrocarbons and carbon disulfide, must be collected in 40 milliliter (mL) glass vials with Teflon® septa. The laboratory will provide pre-preserved (with concentrated hydrochloric acid) vials for the collection of VOCs. Water samples collected for VOCs should be collected with as little agitation or disturbance as possible. The vial should be filled such that there is a meniscus at the top of the vial and absolutely no bubbles or headspace should be present in the vial after it is capped. After the cap is securely tightened, the vial should be inverted and tapped on the palm of one hand to see if any undetected bubbles are dislodged. If a bubble or bubbles are present, the vial should be topped off using a minimal amount of sample to re-establish the meniscus. VOC samples have a 2-week holding time.

### **5.1.4 Laboratory Reporting Limits**

As discussed above in Section 4.1, for all constituents required to be analyzed for the APP, the laboratory RL must be equal to or below the applicable AWQS (preferably below) in order to assess compliance with the permit. Hence, it is important that the analytical laboratory be aware of the applicable AWQSs, or individual permit limits, in the PVM APP to ensure that the method being used provides a low enough reporting limit.

Tables A-3 and B-3 (Appendices A and B) list the applicable water quality standard and acceptable/maximum laboratory reporting limit for each parameter required to be analyzed for the quarterly/biennial APP monitoring. Laboratory personnel must know which reporting limits are needed for which analytes as the required reporting limit may dictate the selected analytical method.

All analytical laboratories contracted by PVM will be licensed by ADHS, Laboratory Licensure Division, for each parameter they are analyzing and reporting.

### **5.1.5 Proper Filling of Sample Bottles**

Powder free, disposable nitrile or latex gloves must be worn when handling bottles during sampling. Fingers can contain contaminants, such as nitrates, sunscreen, etc.

Sample bottles used for analysis of general parameters (anions, total dissolved solids, total suspended solids, alkalinity) and major and minor ions must be filled completely (to the top) with an unfiltered water sample.



Sample bottles for nitrate/nitrite, ammonia, and Kjeldahl analyses must have H<sub>2</sub>SO<sub>4</sub> as a preservative and be filled approximately 95% full (up to the neck) with an unfiltered water sample.

Samples to be analyzed for coliform bacteria must be collected in specific laboratory-supplied, sterilized and pre-treated plastic containers. The containers must be partially filled with sample water, leaving a one-inch head space. Nothing but atmospheric air and the sample water should touch the inside and rim of the container or the inside and rim of the bottle cap.

If there is not enough volume of water at a well site or spring to completely fill all laboratory-provided sample bottles, fill the bottles in the following order:

- Dissolved metals
- Major ions, alkalinity, TDS, pH
- Nitrogen species (nitrate-nitrite, as N)
- Radiochemicals

### **5.1.6 Sample Handling and Transportation**

The type of analysis for each sample collected determines the type of bottle, preservative, holding time, and filtering requirements. Samples must be collected directly from the source (i.e. well, spring, etc.) into the appropriate laboratory-cleaned bottles. Sample identification, date and time, and analysis requested must be written, with a waterproof pen, on each sample bottle.

Samples must be maintained at a temperature of 4° Celsius (or less) until they are delivered to the laboratory.

All water samples will be placed into an ice-packed cooler immediately after collection. If possible, place water bottles inside Ziploc plastic bags first, then into the ice-packed cooler. Melting ice should be prevented from possibly contaminating water samples. One such method used to prevent possible contamination is to fill one-gallon size plastic bags with ice, double-bag, seal, then place on top of, and surrounding, the water samples in the cooler. Samples must be transported to the analytical laboratory as soon as possible to ensure holding times are met.

### **5.1.7 Sample Holding Times**

Each parameter has a specific holding time, which ensures that the results generated are valid. Most parameters have holding times ranging from a number of days to a number of months. However, water samples collected for coliform, chromium VI, nitrate, and/or nitrite analysis must be submitted to the laboratory within a specific number of hours from the collection time. The inorganic parameters with the shortest holding time are nitrate and nitrite; both have a holding time of 48 hours. Water samples that are collected for bacterial analysis typically have a 6-hour holding time.

The recommended container size, container type, sample preservation, and holding times for the parameters that will be analyzed under the APP are presented in Table A-2 in Appendix A of this QAP.

If the maximum holding time-frame (i.e., hours or days) has passed, the data generated through sample analysis should be noted with a “qualifier” during the data validation procedure since its representativeness cannot be guaranteed. Hence, it is important to submit the water samples to the laboratory as soon as possible and within the maximum holding time.

### **5.1.8 Documentation**

Document control procedures will be followed to ensure the reliability and interpretability of the collected data. An electronic field sampling form will be filled out for each monitoring point, for sampling event. In general, data obtained from each sampling event should contain at least the following information:

- sampling location ID (i.e., well number, spring name, etc.) with coordinates or other relevant information;
- details of sampling point (i.e., end of discharge tubing, sampling port, etc.);
- date/time of sample collection;
- method of sampling;
- site/weather conditions;
- name(s) of sampling personnel;
- visual observation of sample appearance;
- water quality parameters collected in the field, and
- any information that may affect the results of the analysis.

All entries must be legible, written in waterproof ink, with the date and time of entry. Photographs taken at a location, if any, should be noted on, and attached to, the electronic sampling form. Ideally, photographs should be compiled into a photo log with date and location of each photo.

Documentation for spring monitoring must also include field notes describing the flow rate, presence or absence of any additional or other areas of spring flow, soil moisture, heavy vegetation present within the prescribed radius of the spring coordinates (for most springs, the prescribed radius is 55 feet).

A laboratory chain-of-custody form must also be completed for each sampling event. The chain-of-custody form is usually a three- or four-copy form. The form is completed by the sampling team, and after signing and relinquishing custody of the samples to the laboratory, the sampler retains the bottom copy. The other copies are retained by the laboratory.

## **5.2 FIELD QC REQUIREMENTS**

### **5.2.1 Duplicates, Equipment Blanks, and Trip Blanks**

As discussed above in Section 4.2.1, USEPA field sampling guidance recommends collecting and submitting QC control samples (i.e., equipment blanks, duplicates, etc.) along with the routine samples at a frequency of one (1) for every ten (10) samples (USEPA, 2004).

PVM will collect at least one (1) duplicate sample every sampling event (quarterly or biennial). The duplicate sample will be collected at the same site (i.e. spring, well, stream, etc.) and at the same time as a routine sample but assigned a sample ID alias to avoid alerting the laboratory that the sample is a duplicate. The true identity of the routine and duplicate samples will be recorded on the electronic sample collection form.

Field equipment blanks are used when sampling equipment is decontaminated and reused in the field, or when a sample collection vessel (i.e., beaker, filter vessel) will be used. Equipment blanks are used to check the “cleanliness” of sample collection equipment, i.e. the decontamination procedures. To collect an equipment blank, first clean/decontaminate the field equipment in accordance with protocol described below in Section 6.3. After cleaning the equipment, an aliquot (a portion) of distilled water is poured over or in the equipment just cleaned (such as over a submersible pump or in a sample collection beaker or filter vessel). The rinse water is collected directly into a sample bottle and is submitted to the laboratory for analysis. One (1) equipment blank will be prepared per day when equipment blanks are needed. Equipment blanks are not needed when using dedicated sampling equipment.

In the event that a water sample is required to be analyzed for volatile organic compounds (VOCs), a trip blank will be included with the water samples. A trip blank is only used for VOC analyses. Trip blanks are used to determine whether contamination has been introduced to water samples through cross-contamination during shipment and storage of sample containers. Trip blanks are prepared at the analytical laboratory, by filling a sample bottle with deionized water and securing the lid. Trip blanks are transported to and from the sampling site with normal sample bottles and analyzed like normal samples. Results from the trip blanks should be free of contamination. If contaminants are seen in trip blank samples, container handling and storage procedures should be re-examined and adjusted.

### **5.3 EQUIPMENT CLEANING/DECONTAMINATION PROCEDURES**

Water sampling equipment, including down well pumps, must be properly cleaned before use. This will ensure that the sampling equipment is not a source of foreign substances that could affect the ambient concentrations of analytes in the water sample.

Equipment should be cleaned in an area protected from airborne or other sources of contamination.

The cleaning procedure used depends on the type(s) of water samples that will be collected and processed. For PVM’s water sampling programs, the following cleaning procedures are appropriate:

- Rinse the sampling equipment with tap water to remove the majority of solids;
- Using a plastic brush or sponge and low- the equipment to remove all residues/phosphate lab detergent (e.g. Alconox, LiquiNox or other phosphate-free, biodegradable liquid detergent), scrub;
- After scrubbing, triple rinse the equipment with tap water; and
- For the final rinse, triple rinse with distilled or deionized water (maximum specific conductivity of 1 microsiemens per centimeter [ $\mu\text{S}/\text{cm}$ ]).

Place cleaned equipment into sealable plastic bags.

Cleaning of submersible pumps and discharge tubing is done by submerging the pump in a container (i.e., clean, appropriately-sized plastic barrel) of clean tap water and pumping continuously for several minutes to ensure the pump and plastic discharge tubing are rinsed thoroughly.

#### **5.4 INSTRUMENT TESTING AND CALIBRATION PROCEDURES**

Water quality meters must be tested and calibrated prior to each sampling trip and periodically during sampling (i.e., every tenth sample). For pH, meters must be calibrated with three (3) buffer solutions: 4.0, 7.0, and 10.0. Conductivity must be calibrated with a standard that is similar to the expected conductivity range of the water that will be sampled. The temperature probe must be calibrated once a year with a NIST-certified thermometer. (This may be accomplished through a request to the contract testing laboratory who will calibrate PVM's thermometer with their NIST-certified thermometer.)

The Standard Operating Procedure (SOP) for calibration of PVM's Hach Hydrolab MSF multiprobe unit is provided in Appendix C of this QAP.

Document information for the most recent calibration, such as the date/time, standard(s), etc. on a water quality sample collection form.

#### **5.5 GROUNDWATER SAMPLING PROCEDURES**

At each well site, the first action will be to unlock the well vault and visually inspect the vault, lock system, equipment, wiring, etc. to ensure there is no damage or vandalism. Any damaged or missing equipment will be noted on the water quality sample collection form.

An electric sounder, that is capable of providing an accuracy of at least 0.1 foot, will be used to measure the groundwater levels. The water surface is indicated by an audible and visual signal when the electric-tape sensor comes in contact with water. The depth-to-water (DTW) below a reference point (measuring point [MP]), commonly the north side of the top of the well casing, will then be recorded. (This reference point should previously have been surveyed to provide the horizontal location and vertical elevation.)

Prior to collecting a water level at each well, the water level probe on the electric sounder will be sprayed or rinsed with distilled/deionized water.

All APP compliance wells are equipped with a dedicated (permanent) pump, discharge piping, appropriate headers, and sounder tube. A common generator and control box will be used for all wells. For wells that do not have a dedicated (permanent) pump, the portable electric submersible pump, control box, electric generator, and discharge tubing must be assembled prior to sampling. The non-dedicated electric submersible pump and discharge tubing must be decontaminated prior to use at each location.

For each water level measurement, the date, time, measured DTW, height of measuring point above land surface, measuring point reference datum, and names of field personnel must be recorded on the water quality sample collection form.

Construction data on each well should be reviewed prior to purging and sampling a well. Following the DTW measurement, the total depth and casing diameter of the well must be known in order to calculate the volume of standing (stagnant) water in the well (for purging). If a dedicated pump is not installed, the screened interval must be known in order to place the

submersible pump at the appropriate depth. The pump must be set no higher than slightly above the middle of the screened interval.

Some wells may be equipped with a pressure transducer that records continuous water level data. In order to confirm the readings from the pressure transducers, water level measurements will be collected at these wells on a quarterly basis using manual electric sounders. The manual measurements will be recorded on the water quality sample collection form, and if needed, the pressure transducer will be re-calibrated to agree with the manual measurement.

### 5.5.1 Purging

Purging is the process of removing stagnant water from a well immediately prior to sampling, causing its replacement by groundwater from the adjacent formation that is representative of actual aquifer conditions. There are a number of purging strategies that are accepted by the USEPA and that may be used depending on the specific hydrologic conditions of the well.

If feasible, wells will be purged of at least three (3) borehole volumes (as calculated using the static water level) or until field parameters (pH, temperature, and conductivity at a minimum) are stable, whichever represents the greater volume.

If the well has been sampled before, review past field data sheets for purge rates, total purge time, stabilized field parameter values, and amount of drawdown prior to sample collection.

If purging results in the well going dry, the well will be allowed to recover to 80% of the original borehole volume, or for 24 hours, whichever is shorter, prior to sampling. (Samples should be collected within 24 hours of the final purge/recovery cycle.) If, after 24 hours, there is not sufficient water for sampling, the well will be recorded as “dry” for the monitoring event.

The traditional purge method consists of calculating the amount of water standing in the water column (well volume) and multiplying that value by three (3). An adequate purge volume is considered achieved when three (3) casing volumes have been removed. The water quality sample collection form should show the calculation steps and each specific factor (i.e., casing diameter, depth of well, etc.)

To determine the volume of water to be purged, use the following equation:

$$\text{Casing volume (CV)} = (D/24)^2 * (3.14) * (7.48) * (TD - DTW)$$

where:

D = diameter of well/piezometer/boring (in inches)

TD = total depth of well (in feet)

DTW = depth to groundwater, as measured (in feet)

Field indicator parameters must be taken at regular intervals (approximately every 5 to 15 minutes) during purging and recorded (water quality sample collection form). If, after removing three (3) casing volumes from the well, the field indicator parameters have not stabilized (within 10 percent for at least three [3] consecutive readings), additional well volumes may be removed. The total purge volume must be noted on the water quality sample collection form.

Low-flow, or micro-purging is another acceptable purging method. This method consists of purging the well at a low discharge rate, ranging from less than 0.1 to 3 gallons per minute

(gpm), and monitoring the water levels during purging to maintain minimal drawdown. Indicator parameter (pH, temperature, conductivity, etc.) measurements are taken at regular intervals (i.e., every 5 to 15 minutes) and purging continues until the parameters have stabilized. An adequate purge is achieved when the pH remains constant within 0.1 Standard Unit (SU) and conductivity varies no more than 5 percent. Turbidity will either be stabilized or will be below 10 Nephelometric turbidity units (NTUs).

Advantages for using low-flow purging include: better data, reduced purge water volume, and reduced turbidity.

The pumping rate for a pump can be determined by collecting the discharge (purge water) from the discharge tube in a 5-gallon bucket and timing (with a stop watch) how long it takes to fill the bucket. The pumping rate should be recorded in gpm.

Regardless of the selected purge method, field indicator parameters (pH, conductivity, and temperature at a minimum) must be taken at regular intervals (approximately every 5 to 15 minutes) during purging and recorded on the water quality sample collection form. An explanation for reduced pumping volumes, a record of the volume pumped, and modified sampling procedures must be documented in the field sampling forms.

In accordance with A.A.C. R18-9-B301.D (General Permit A1.04), purge water will be discharged to the ground surface and allowed to infiltrate into the ground.

It is important that the wells be sampled as soon as possible after purging. Groundwater samples will typically be collected from the discharge line of a pump. Efforts should be made to reduce the flow from the pump discharge line during sample collection to minimize sample agitation. The pump discharge line should not contact the sample container.

If a portable submersible pump is used for purging/sampling, it will be cleaned after each use to avoid contamination of the next sample (see Section 6.3).

## **5.6 SPRING WATER SAMPLING & FLOW MEASUREMENT PROCEDURES**

Prior to sampling or monitoring flow conditions at a spring, a review should be conducted of the past spring monitoring data, including photos, access routes, and field observations, such as spatial extent of spring/seep, approximate rate of flow, etc.

Before starting field work, the sampler(s) should review the equipment checklist provided in Section 6.1 and confirm that the sampling equipment and supplies are available, clean, and in working condition. In addition to the items listed in Section 6.1, the following field equipment should be included in spring sampling activities:

- A clean/ decontaminated, 4-liter plastic container (or bucket or similar collection vessel).
- 60 mL disposable syringes (one per sample).
- Clean, unused 1-gallon plastic bags.
- Peristaltic pump, if field-filtering.
- 0.45 micron pore size filters, if field filtering.

For spring monitoring, the latitude/longitude listed in Table 4.2-1 of the APP will be used as the definitive location for each spring. In addition to assessing flow conditions (presence/absence of water) at the coordinates, the flow rate will be recorded. The minimum flow rate for spring sampling is 0.20 gpm; springs/seeps with flow rates less than 0.20 gpm will not be sampled.

Valid water samples are only collected from springs if sufficient water is flowing from the spring, (i.e., water is not standing or ponded or collected in a tank). The chemical composition of ponded water is not representative of the groundwater that daylights at a spring location. Standing water contained in nearby tanks, stock ponds, or pools of water is not representative of the actual spring itself. Therefore, if a water sample cannot be collected directly from the fracture or surface flow, as close to the emergence point as possible, do not collect a sample.

Upon arrival at the designated spring location, rinse the sample beaker three (3) times with spring water, then collect a sample of the spring water in the beaker and obtain in situ measurements of temperature, pH, conductivity, and dissolved oxygen. Record the readings on a water quality sample collection form.

Collect spring sample using a clean syringe (from its package). Place the syringe tip at least one inch below the surface of the water at the designated sampling location and fill it slowly by pulling back on the plunger. Avoid drawing sediment or other foreign materials into the syringe. Using the syringe, fill each of the laboratory sample bottles.

Lists of the specific parameters, analytical methods, containers, and required preservatives for the APP spring monitoring are provided in Appendices A and B of this QAP.

Samples collected for dissolved metals may be filtered in the field using a peristaltic pump and 0.45 micron pore size filters. Water samples filtered in the field must be collected in a nitric acid (HNO<sub>3</sub>)-preserved laboratory bottle. It should be noted on the sample bottle label and COC form if the samples are field-filtered.

If there is not enough volume of water at a spring to completely fill all laboratory-provided sample bottles, fill the bottles in the following order:

- Dissolved metals (quarterly).
- Major ions, alkalinity, TDS, pH (quarterly, biennially).
- Nitrogen species (nitrate-nitrite, as N) (quarterly).
- Radiochemicals (quarterly).

If there is sufficient volume of water from a given spring, collect and submit one (1) duplicate sample for analyses per quarterly sampling event (or one duplicate for every ten (10) water quality samples).

Sample identification, date and time must be written, with a waterproof pen, on each sample bottle. Store the sample bottles in a cooler packed with ice, then transport to the analytical laboratory as soon as possible, keeping in mind the applicable holding times.

The flow rate (or discharge) of the spring will be measured, or at least estimated, and recorded on the electronic sample collection form. Estimate the volume of water from a spring by filling up a container of known volume (e.g., gallon-size plastic bag, or other container) and using a stop watch to time how long it takes to fill up the container. The flow of water is expressed in units of volume per time (i.e., gpm).

## 6.0 REFERENCES

Arizona Water Resources Research Center, 1996. *Field Manual for Water Quality Sampling*.  
University of Arizona, College of Agriculture, Tucson, Arizona; July 1996.

USEPA, 2004. *Field Sampling Guidance Document #1220 – Groundwater Well Sampling*.  
U.S.EPA Region 9 Laboratory, Richmond, California; Revision 1, September 2004.



# **APPENDIX A**

## **APP Quarterly Monitoring Tables**

**TABLE A-1 POINTS OF COMPLIANCE - QUARTERLY ANALYTE LIST**

ANALYTE	METHOD	CONTAINER / PRESERVATIVE	POC Wells									POC Springs		Alert Level Monitoring Points			
			APP-1A	APP-1BR	APP-2	APP-3A	APP-3B	APP-4	APP-5A	APP-5B	APP-6	MG1-6b	North Draw 1	MG1-12b	MG1-7a	APP-7	
pH - field	N/A	N/A	A	A	A	A	A	A	A	A	A	A	A	A	A	A	A
Temperature - field	N/A	N/A	A	A	A	A	A	A	A	A	A	A	A	A	A	A	A
Specific conductance - field	N/A	N/A	A	A	A	A	A	A	A	A	A	A	A	A	A	A	A
Total dissolved solids	SM 2540 C	Cool < 4° C	A	A	A	A	A	A	A	A	A	A	A	A	A	A	A
Sulfate	EPA 300.0	Cool < 4° C	A	A	A	A	A	A	A	A	A	A	A	A	A	A	A
Fluoride	EPA 300.0	Cool < 4° C	A	A	A	A	A	A	A	A	A	A	A	A	A	A	A
Nitrate-nitrite (as N)	EPA 353.2	H2SO4 to pH <2	A	A	A	A	A	A	A	A	A	A	A	A	A	A	A
Aluminum	EPA 200.7	HNO3 to pH <2	--	--	--	--	--	--	--	--	A	--	--	--	--	--	--
Antimony	EPA 200.8	HNO3 to pH <2	A	A	A	A	A	A	A	A	A	A	A	A	A	A	A
Arsenic	EPA 200.7	HNO3 to pH <2	A	A	A	A	A	A	A	A	A	A	A	A	A	A	A
Beryllium	EPA 200.7	HNO3 to pH <2	A	A	A	A	A	A	--	A	A	A	A	A	A	A	A
Cadmium	EPA 200.8	HNO3 to pH <2	A	A	A	A	A	A	--	A	A	A	A	A	A	A	A
Cobalt	EPA 200.7	HNO3 to pH <2	A	A	A	A	A	A	--	A	A	A	A	A	A	A	A
Copper	EPA 200.7	HNO3 to pH <2	A	A	A	A	A	A	A	A	A	A	A	A	A	A	A
Iron	EPA 200.7	HNO3 to pH <2	A	A	A	A	A	A	A	A	A	A	A	A	A	A	A
Lead	EPA 200.8	HNO3 to pH <2	A	A	A	A	A	--	A	A	A	A	A	A	A	A	A
Manganese	EPA 200.7	HNO3 to pH <2	A	A	A	A	A	A	A	A	A	A	A	A	A	A	A
Nickel	EPA 200.7	HNO3 to pH <2	A	A	A	A	A	--	A	A	A	A	A	A	A	A	A
Selenium	EPA 200.8	HNO3 to pH <2	A	A	A	A	A	A	A	A	A	A	A	A	A	A	A
Zinc	EPA 200.7	HNO3 to pH <2	A	A	A	A	A	A	A	A	A	A	A	A	A	A	A
Gross Alpha	EPA 900	HNO3 to pH <2	--	--	--	--	--	--	--	--	--	--	--	A	A	--	--

All metals and radiochemical analyses must be sampled and analyzed as dissolved metals/radionuclides.

N/A = not applicable

A = request analysis for this constituent in this well.

- = do not request analysis for this constituent in this well.

**TABLE A-2 SAMPLE CONTAINER TYPES, REQUIRED PRESERVATIVES, AND HOLDING TIMES FOR QUARTERLY ANALYTES**

ANALYTE	METHOD	CONTAINER	PRESERVATIVE	ADDITIONAL PREPARATION	HOLDING TIME
pH - field	N/A	N/A	N/A	N/A	Analyze within 15 minutes of sample collection
Temperature - field	N/A	N/A	N/A	N/A	Analyze within 15 minutes of sample collection
Specific conductance - field	N/A	N/A	N/A	N/A	Analyze within 15 minutes of sample collection
Total dissolved solids	SM 2540 C	500 mL plastic (or glass)	Cool to < 4° C	N/A	7 days
Sulfate	EPA 300.0		Cool to < 4° C	N/A	28 days
Fluoride	EPA 300.0		Cool to < 4° C	N/A	28 days
Nitrate-nitrite (as N)	EPA 353.2	250 mL plastic	H2SO4 to pH <2 Cool to < 4° C	N/A	28 days
Aluminum	EPA 200.7	500 mL plastic (or glass)	HNO3 to pH <2 Cool to < 4° C	Field filter	6 months
Antimony	EPA 200.8		HNO3 to pH <2 Cool to < 4° C	Field filter	6 months
Arsenic	EPA 200.7		HNO3 to pH <2 Cool to < 4° C	Field filter	6 months
Beryllium	EPA 200.7		HNO3 to pH <2 Cool to < 4° C	Field filter	6 months
Cadmium	EPA 200.8		HNO3 to pH <2 Cool to < 4° C	Field filter	6 months
Cobalt	EPA 200.7		HNO3 to pH <2 Cool to < 4° C	Field filter	6 months
Copper	EPA 200.7		HNO3 to pH <2 Cool to < 4° C	Field filter	6 months
Iron	EPA 200.7		HNO3 to pH <2 Cool to < 4° C	Field filter	6 months
Lead	EPA 200.8		HNO3 to pH <2 Cool to < 4° C	Field filter	6 months
Manganese	EPA 200.7		HNO3 to pH <2 Cool to < 4° C	Field filter	6 months
Nickel	EPA 200.7		HNO3 to pH <2 Cool to < 4° C	Field filter	6 months
Selenium	EPA 200.8		HNO3 to pH <2 Cool to < 4° C	Field filter	6 months
Zinc	EPA 200.7		HNO3 to pH <2 Cool to < 4° C	Field filter	6 months
Gross Alpha	EPA 900	3 1-liter plastic (or glass)	HNO3 to pH <2 Cool to < 4° C	N/A	6 months

All metals and radiochemical analyses must be sampled and analyzed as dissolved metals/radionuclides.

N/A = not applicable; samples not submitted to laboratory

mL = milliliter

P = plastic, polypropylene, polyethylene

4° C = 39.2° Fahrenheit

**TABLE A-3 APPLICABLE WATER QUALITY STANDARDS AND ACCEPTABLE/MAXIMUM LABORATORY REPORTING LIMITS**

<b>ANALYTE</b>	<b>METHOD</b>	<b>UNITS</b>	<b>APPLICABLE WATER QUALITY STANDARD</b>	<b>ACCEPTABLE / MAXIMUM LABORATORY REPORTING LIMIT <sup>1</sup></b>
pH - field	N/A	S.U.	6 - 9	N/A
Temperature - field	N/A	° F	NNS	N/A
Specific conductance - field	N/A	µmhos/cm	NNS	N/A
Total dissolved solids	SM 2540 C	mg/L	NNS	40
Sulfate	EPA 300.0	mg/L	NNS	5.0
Fluoride	EPA 300.0	mg/L	4.0	1.0
Nitrate-nitrite (as N)	EPA 353.2	mg/L	10.0	1.0
Aluminum	EPA 200.7	mg/L	NNS	0.10
Antimony	EPA 200.8	mg/L	0.006	0.004
Arsenic	EPA 200.7	mg/L	0.05	0.025
Beryllium	EPA 200.7	mg/L	0.004	0.002
Cadmium	EPA 200.8	mg/L	0.005	0.002
Cobalt	EPA 200.7	mg/L	NNS	0.10
Copper	EPA 200.7	mg/L	NNS	0.10
Iron	EPA 200.7	mg/L	NNS	0.10
Lead	EPA 200.8	mg/L	0.05	0.01
Manganese	EPA 200.7	mg/L	NNS	0.10
Nickel	EPA 200.7	mg/L	0.10	0.01
Selenium	EPA 200.8	mg/L	0.05	0.01
Zinc	EPA 200.7	mg/L	NNS	0.10
Gross Alpha	EPA 900	pCi/L	NNS	3.0

<sup>1</sup> : The laboratory reporting limit should be equal to or less than the value presented in this column.

All metals and radiochemical analyses must be sampled and analyzed as dissolved metals/radionuclides.

N/A = not applicable; samples not submitted to laboratory

S.U. = Standard units

F = Fahrenheit

µmhos/cm = micromhos per centimeter

mg/L = milligrams per liter

pCi/L = picoCuries per liter

NNS = No numeric water quality standard for this constituent

## **APPENDIX B**

### **APP Biennial Monitoring Tables**

**TABLE B-1 POINTS OF COMPLIANCE - BIENNIAL ANALYTE LIST**

ANALYTE	METHOD	POC Wells									POC Springs		Alert Level Monitoring Points		
		APP-1A	APP-1BR	APP-2	APP-3A	APP-3B	APP-4	APP-5A	APP-5B	APP-6	MG1-6b	North Draw 1	MG1-12b	MG1-7a	APP-7
pH - field	N/A	A	A	A	A	A	A	A	A	A	A	A	A	A	A
Temperature - field	N/A	A	A	A	A	A	A	A	A	A	A	A	A	A	A
Specific conductance - field	N/A	A	A	A	A	A	A	A	A	A	A	A	A	A	A
pH - lab	SM 4500 H B	A	A	A	A	A	A	A	A	A	A	A	A	A	A
Specific conductance - lab	EPA 120.1	A	A	A	A	A	A	A	A	A	A	A	A	A	A
Chloride	EPA 300.0	A	A	A	A	A	A	A	A	A	A	A	A	A	A
Carbonate	SM 2320B	A	A	A	A	A	A	A	A	A	A	A	A	A	A
Bicarbonate	SM 2320B	A	A	A	A	A	A	A	A	A	A	A	A	A	A
Total Alkalinity	SM 2320B	A	A	A	A	A	A	A	A	A	A	A	A	A	A
Calcium	EPA 200.7	A	A	A	A	A	A	A	A	A	A	A	A	A	A
Magnesium	EPA 200.7	A	A	A	A	A	A	A	A	A	A	A	A	A	A
Potassium	EPA 200.7	A	A	A	A	A	A	A	A	A	A	A	A	A	A
Sodium	EPA 200.7	A	A	A	A	A	A	A	A	A	A	A	A	A	A
Aluminum	EPA 200.7	A	A	A	A	A	A	A	A	--	A	A	A	A	A
Arsenic	EPA 200.7	--	--	--	--	--	--	--	--	A	--	--	--	--	--
Barium	EPA 200.7	A	A	A	A	A	A	A	A	A	A	A	A	A	A
Beryllium	EPA 200.7	--	--	--	--	--	--	A	--	--	--	--	--	--	--
Cadmium	EPA 200.8	--	--	--	--	--	--	A	--	--	--	--	--	--	--
Chromium (total)	EPA 200.7	A	A	A	A	A	A	A	A	A	A	A	A	A	A
Cobalt	EPA 200.7	--	--	--	--	--	--	A	--	--	--	--	--	--	--
Cyanide (total)	EPA 335.4	A	A	A	A	A	A	A	A	A	A	A	A	A	A
Lead	EPA 200.8	--	--	--	--	--	A	--	--	--	--	--	--	--	--
Mercury	EPA 245.1	A	A	A	A	A	A	A	A	A	A	A	A	A	A
Nickel	EPA 200.7	--	--	--	--	--	A	--	--	--	--	--	--	--	--
Thallium	EPA 200.8	A	A	A	A	A	A	A	A	A	A	A	A	A	A
Gross alpha	EPA 900.0	A	A	A	A	A	A	A	A	A	A	A	--	--	A
Adjusted gross alpha	Calculation	A	A	A	A	A	A	A	A	A	A	A	A	A	A
Radium 226+228	EPA 903/904	A	A	A	A	A	A	A	A	A	A	A	A	A	A
Uranium (combined)	U-02-RC	A	A	A	A	A	A	A	A	A	A	A	A	A	A
Cation/anion balance	Calculation	A	A	A	A	A	A	A	A	A	A	A	A	A	A
For ion balance calculation:															
Fluoride	EPA 300.0	A	A	A	A	A	A	A	A	A	A	A	A	A	A
Sulfate	EPA 300.0	A	A	A	A	A	A	A	A	A	A	A	A	A	A
Nitrate-nitrite, as N	EPA 353.2	A	A	A	A	A	A	A	A	A	A	A	A	A	A

All metals and radiochemical analyses must be sampled and analyzed as dissolved metals/radionuclides.

N/A = not applicable

A = request analysis for this constituent in this well.

- = do not request analysis for this constituent in this well.

**TABLE B-2 SAMPLE CONTAINER TYPES, REQUIRED PRESERVATIVES, AND HOLDING TIMES**

ANALYTE	METHOD	CONTAINER	PRESERVATIVE	ADDITIONAL PREPARATION	HOLDING TIME
pH - field	N/A	N/A	N/A	N/A	Analyze within 15 minutes of sample collection
Temperature - field	N/A	N/A	N/A	N/A	Analyze within 15 minutes of sample collection
Specific conductance - fi	N/A	N/A	N/A	N/A	Analyze within 15 minutes of sample collection
pH - lab	SM 4500 H B	500 mL plastic (or glass)	Cool to < 4° C	N/A	14 days
Specific conductance - la	EPA 120.a		Cool to < 4° C	N/A	28 days
Chloride	EPA 300.0		Cool to < 4° C	N/A	28 days
Carbonate	SM 2320B		Cool to < 4° C	N/A	14 days
Bicarbonate	SM 2320B		Cool to < 4° C	N/A	14 days
Total Alkalinity	SM 2320B		Cool to < 4° C	N/A	14 days
Calcium	EPA 200.7		500 mL plastic (or glass)	HNO3 to pH <2 Cool to < 4° C	N/A
Magnesium	EPA 200.7	HNO3 to pH <2 Cool to < 4° C		N/A	6 months
Potassium	EPA 200.7	HNO3 to pH <2 Cool to < 4° C		N/A	6 months
Sodium	EPA 200.7	HNO3 to pH <2 Cool to < 4° C		N/A	6 months
Aluminum	EPA 200.7	HNO3 to pH <2 Cool to < 4° C		Field filter	6 months
Arsenic	EPA 200.7	HNO3 to pH <2 Cool to < 4° C		Field filter	6 months
Barium	EPA 200.7	HNO3 to pH <2 Cool to < 4° C		Field filter	6 months
Beryllium	EPA 200.7	HNO3 to pH <2 Cool to < 4° C		Field filter	6 months
Cadmium	EPA 200.8	HNO3 to pH <2 Cool to < 4° C		Field filter	6 months
Chromium (total)	EPA 200.7	HNO3 to pH <2 Cool to < 4° C		Field filter	6 months
Cobalt	EPA 200.7	HNO3 to pH <2 Cool to < 4° C		Field filter	6 months
Cyanide (total)	EPA 335.4	HNO3 to pH <2 Cool to < 4° C		Field filter	6 months
Lead	EPA 200.8	HNO3 to pH <2 Cool to < 4° C		Field filter	6 months
Mercury	EPA 245.1	HNO3 to pH <2 Cool to < 4° C		Field filter	6 months
Nickel	EPA 200.7	HNO3 to pH <2 Cool to < 4° C		Field filter	6 months
Thallium	EPA 200.8	HNO3 to pH <2 Cool to < 4° C	Field filter	6 months	
Adjusted gross alpha	Calculation	N/A	N/A	N/A	N/A
Gross alpha	EPA 900.0	3 1-liter plastic (or glass)	HNO3 to pH <2 Cool to < 4° C	N/A	6 months
Radium 226+228	EPA 903/904		HNO3 to pH <2 Cool to < 4° C	N/A	6 months
Uranium (combined)	U-02-RC		HNO3 to pH <2 Cool to < 4° C	N/A	6 months
Cation/anion balance	Calculation	N/A	N/A	N/A	N/A
For ion balance calculation:					
Fluoride	EPA 300.0	500 mL plastic (or glass) - with 500 mL nonpreserved bottle above	Cool to < 4° C	N/A	28 days
Sulfate	EPA 300.0		Cool to < 4° C	N/A	28 days
Nitrate-nitrite, as N	EPA 353.2	500 mL plastic (or glass)	H2SO4 to pH <2 Cool to < 4° C	N/A	28 days

All metals and radiochemical analyses must be sampled and analyzed as dissolved metals/radionuclides.

N/A = not applicable

mL = milliliter

P = plastic, polypropylene

4° C = 39.2° Fahrenheit

**TABLE B-3 APPLICABLE WATER QUALITY STANDARDS AND ACCEPTABLE / MAXIMUM LABORATORY REPORTING LIMITS**

ANALYTE	METHOD	UNITS	APPLICABLE WATER QUALITY STANDARD	ACCEPTABLE / MAXIMUM LABORATORY REPORTING LIMIT <sup>1</sup>
pH - field	N/A	S.U.	6 - 9	N/A
Temperature - field	N/A	° F	NNS	N/A
Specific conductance - field	N/A	µmhos/cm	NNS	N/A
pH - lab	SM 4500 H B	mg/L	6 - 9	N/A
Specific conductance - lab	EPA 120.1	µmhos/cm	NNS	5.0
Chloride	EPA 300.0	mg/L	NNS	10.0
Carbonate	SM 2320B	mg/L	NNS	1.0
Bicarbonate	SM 2320B	mg/L	NNS	1.0
Total Alkalinity	SM 2320B	mg/L	NNS	1.0
Calcium	EPA 200.7	mg/L	NNS	0.10
Magnesium	EPA 200.7	mg/L	NNS	0.50
Potassium	EPA 200.7	mg/L	NNS	1.0
Sodium	EPA 200.7	mg/L	NNS	1.0
Aluminum	EPA 200.7	mg/L	NNS	0.10
Arsenic	EPA 200.7	mg/L	0.05	0.025
Barium	EPA 200.7	mg/L	2.0	0.10
Beryllium	EPA 200.7	mg/L	0.004	0.002
Cadmium	EPA 200.8	mg/L	0.005	0.002
Chromium (total)	EPA 200.7	mg/L	0.10	0.01
Cobalt	EPA 200.7	mg/L	NNS	0.10
Cyanide (total)	EPA 335.4	mg/L	NNS <sup>2</sup>	0.01
Lead	EPA 200.8	mg/L	0.05	0.01
Mercury	EPA 245.1	mg/L	0.002	0.0002
Nickel	EPA 200.7	mg/L	0.10	0.01
Thallium	EPA 200.8	mg/L	0.002	0.001
Gross alpha	EPA 900.0	pCi/L	NNS	3.0
Adjusted gross alpha	Calculation	pCi/L	15.0	3.0
Radium 226+228	EPA 903/904	pCi/L	5.0	1.0
Uranium (combined)	U-02-RC	pCi/L	NNS	1.0
Cation/anion balance	Calculation	meq/L	NNS	N/A
For ion balance calculation:				
Fluoride	EPA 300.0	mg/L	4.0	1.0
Sulfate	EPA 300.0	mg/L	NNS	5.0
Nitrate-nitrite, as N	EPA 353.2	mg/L	10.0	1.0

<sup>1</sup> = The laboratory reporting limit should be equal to or less than the value presented in this column.

<sup>2</sup> = The APP requires analysis of Total Cyanide, which does not have a water quality standard. Free cyanide has a water quality standard of 0.20 mg/L.

All metals and radiochemical analyses must be sampled and analyzed as dissolved metals/radionuclides.

N/A = not applicable; samples not submitted to laboratory

S.U. = Standard units

F = Fahrenheit

µmhos/cm = micromhos per centimeter

mg/L = milligrams per liter

pCi/L = picoCuries per liter

NNS = No numeric water quality standard for this constituent

meq/L = milliequivalent per liter



## **APPENDIX C**

### **Standard Operating Procedures for Calibration of Field Water Quality Meter**



Catalog Number 003078HY

# **Hydrolab DS5X, DS5, and MS5 Water Quality Multiprobes**

USER MANUAL

February 2006, Edition 3

## Section 4 Operation

### CAUTION

*When loosening removable parts from a multiprobe, always point those parts away from your body and other people. In extreme conditions, excess pressure may build-up inside any underwater housing, causing the caps, sensors, or other removable parts to disengage with force which may cause serious injury.*

The Sondes use Hydras 3 LT or a Surveyor to set up parameters and calibrate the sensors.

Figure 6 Operations Setup

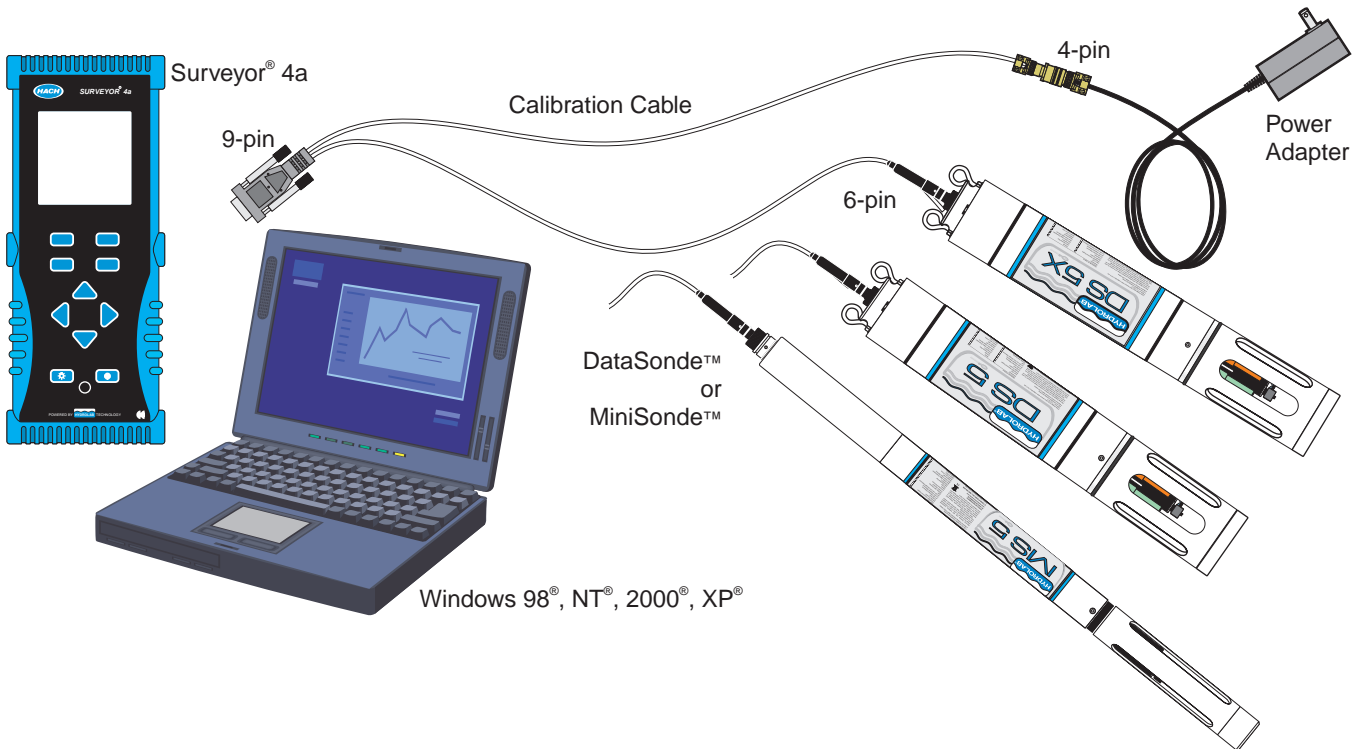

## 4.1 Parameter Setup

### 4.1.1 Using the Surveyor for Parameter Setup

For more information on the Surveyor, refer to the User Manual (Cat. No. 00719618).

1. Attach the power and data cable to the Sonde. Attach the 9-pin connector to the Surveyor.
2. Turn on the Surveyor. Wait approximately 10 seconds for initialization.
3. Press **SETUP/CAL**. Press **SETUP**. Press **SONDE**.
4. Highlight Parameters and press **SELECT**.
5. Use the **ARROW** keys to highlight the appropriate parameter and press **SELECT**.
6. Highlight the appropriate function and press **SELECT**. A configuration screen will be displayed. Depending on the application, use the **ARROW** keys to change the function, press **SELECT** and **DONE** to finish.

### 4.1.2 Using Hydras 3 LT for Parameter Setup

For more information on Hydras 3 LT, refer to the Quick Start Guide (Cat. No. 6234289) or press the **F1** key while Hydras 3 LT is active.

1. Attach the power and data cable to the Sonde. Attach the 9-pin connector to a PC.
2. Start Hydras 3 LT. Wait for the software to scan for connected Sondes. Highlight the multiprobe and press **OPERATE SONDE**.

**Note:** If the Sonde appears to be connected and the software does not recognize the Sonde connection, remove and replace the connector cable and press **RE-SCAN FOR SONDE**. Repeat until Hydras 3 LT recognizes the Sonde.

3. Click on the Parameter Setup tab and select the parameter tab to be configured.
4. Enter the appropriate values and press **SAVE SETTINGS**.

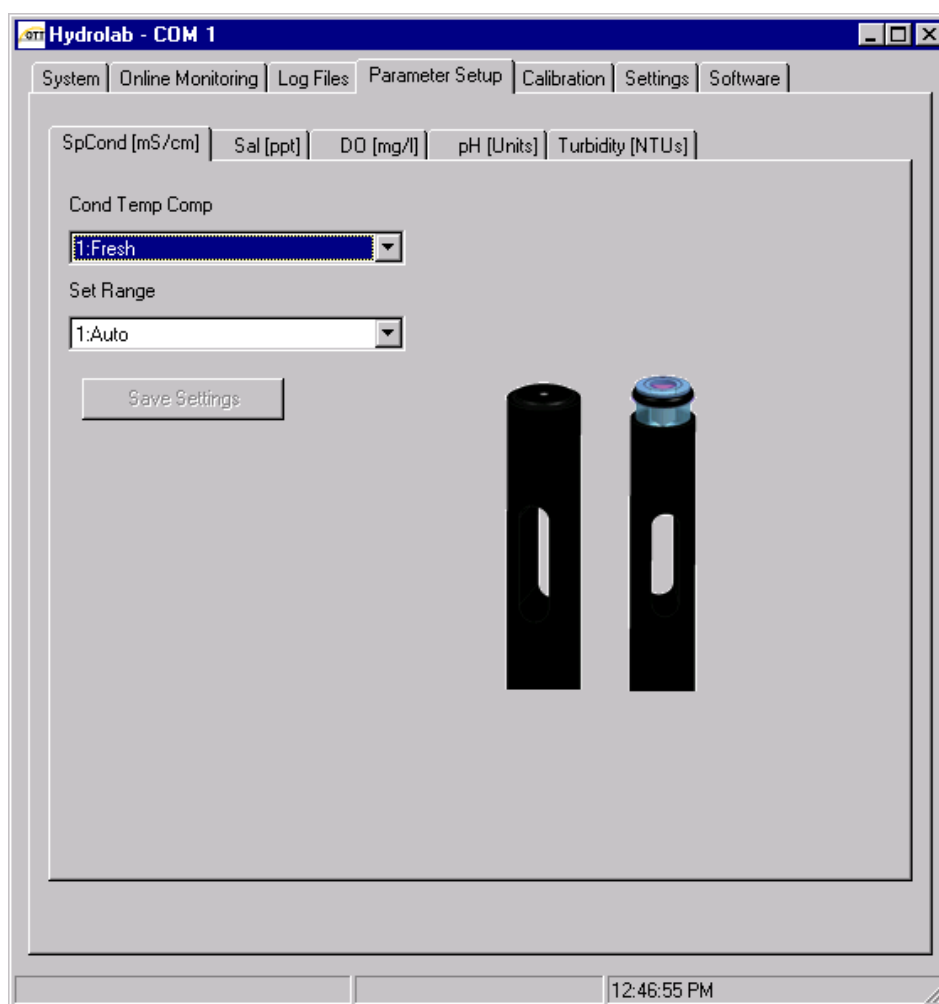

### 4.1.3 Specific Conductance Parameter Setup

For specific conductance set the following functions using Hydras 3 LT or the Surveyor:

- Select the specific conductance function (Fresh, Salt, StdMth, None, or Custom).
  - **Fresh** (default) is based on the manufacturer's freshwater temperature compensation. This function is derived from

$$0.01N \text{ KCl: } f(T) = c_1T^5 + c_2T^4 + c_3T^3 + c_4T^2 + c_5T + c_6,$$

where:

$$c_1 = 1.4326 \times 10^{-9}, c_2 = -6.0716 \times 10^{-8}, c_3 = -1.0665 \times 10^{-5}, c_5 = -5.3091 \times 10^{-2}, c_6 = 1.8199.$$

- **Salt** is based on the manufacturer's saltwater compensation.

$$f(T) = c_1T^7 + c_2T^6 + c_3T^5 + c_4T^4 + c_5T^3 + c_6T^2 + c_7T + c_8$$

where:

$$c_1 = 1.2813 \times 10^{-11}, c_2 = -2.2129 \times 10^{-9}, c_3 = 1.4771 \times 10^{-7}, c_4 = -4.6475 \times 10^{-6}, \\ c_5 = 5.6170 \times 10^{-5}, c_6 = 8.7699 \times 10^{-4}, c_7 = -6.1736 \times 10^{-2}, c_8 = 1.9524.$$

- **StdMth** will remove any temperature compensation, so the readings are equivalent to conductivity:  $f(T)=1$ .
- **Custom** will provide a compensation function that the user can define according to the following function:  

$$f(T) = aT^7 + bT^6 + cT^5 + dT^4 + eT^3 + fT^2 + gT + h.$$
- Select the Set Range (1:Auto, 2:High, 3:Mid, or 4:Low).
  - **Auto** (default) allows the multiprobe to automatically select the most appropriate range to measure conductivity. The multiprobe will dynamically change the range based on the current measurement conditions over 0–100 mS/cm. The resolution of the displayed data will also change to accommodate the current range in use.
  - **High, Mid, and Low** force the multiprobe to measure conductivity using a fixed range. If low range is selected, the readings will indicate an over-ranged condition for values above 1.5 mS/cm. The Mid range will over-range at 15 mS/cm. These choices also force the displayed readings to a fixed point or constant resolution format primarily only needed for certain SDI-12 data loggers. Otherwise, it is best to always select the Auto choice as this gives the best accuracy and performance for the conductivity sensor.
- Select the computation method for salinity (1:2311 or 2:StdMth).
  - **2311** (default): salinity is computed using an algorithm adapted from the United States Geological Survey Water-Supply Paper 2311 titled "Specific Conductance: Theoretical Considerations and Application to Analytical Quality Control". This salinity function is only defined from salinities in the 30 to 40 ppt range (mild concentrations and dilutions of sea water). This salinity function uses specific conductance values C in mS/cm compensated.

$$\text{Salinity} = c_1C^4 + c_2C^3 + c_3C^2 + c_4C + c_5$$

where:

$$c_1 = 5.9950 \times 10^{-8}, c_2 = -2.3120 \times 10^{-5}, c_3 = 3.4346 \times 10^{-3}, c_4 = 5.3532 \times 10^{-1}, \\ c_5 = -1.5494 \times 10^{-2}.$$

- **StdMth**: salinity will be computed using the Practical Salinity Scale (1978). This algorithm is defined for salinities ranging from 2 to 42 ppt and uses conductivity values corrected to 15 °C, regardless of the compensation function selected for specific conductance. This algorithm is described in section 2520B of "Standard Methods for the Examination of Water and Wastewater", 18th edition.

### 4.1.4 Clark Cell Dissolved Oxygen Parameter Setup

For dissolved oxygen, set the following functions using Hydras 3 LT or the Surveyor: Enable or Disable Salinity Compensation.

### 4.1.5 pH Parameter Setup

For pH, set the following functions using Hydras 3 LT or the Surveyor: Select either 2 or 3 calibration points.

### 4.1.6 Other Parameter Setup

Refer to the sensor specific instruction sheet for more information.

## 4.2 Calibration

**Sensors are checked for calibration before they leave the factory, however calibration needs to be specific for a site and application. Check the calibration prior to the first use.**

Calibrate the sensors when:

- Fouling has occurred or is noticeable (site-specific).
- Parameter measurements do not match those of a known calibrated standard.
- Adding or removing certain components for different applications (e.g., the circulator) or when replacing components (e.g., the Teflon junction of the pH reference electrode).

Some system components are affected by time, usage, and the environment. To ensure instrument accuracy, it is recommended to perform routine tests of the system under standard conditions. The multiprobe can be calibrated in the field or at a facility. Equipment checks and adjustment made before going to the field tend to be more precise than those made under field conditions.

### 4.2.1 Calibrating the Sensors Using the Surveyor

**For more information on the Surveyor, refer to the User Manual (Cat. No. 00719618).**

1. Attach the power and data cable to the Sonde. Attach the 9-pin connector to the Surveyor.
2. Turn on the Surveyor. Wait approximately 10 seconds for initialization.
3. Press **SETUP/CAL**. Press **CALIBRATION**. Press **SONDE**.
4. Use the **ARROW** keys to highlight the appropriate parameter and press **SELECT**.
5. Highlight the function to program and press **SELECT**. A calibration screen will be displayed. Depending on the application, use the **ARROW** keys to change the function, press **SELECT**, and **DONE** to finish the calibration.

### 4.2.2 Calibrating the Sensors Using Hydras 3 LT

For more information on Hydras 3 LT, refer to the Quick Start Guide (Cat. No. 6234289) or press the F1 key while Hydras 3 LT is active.

1. Attach the power and data cable to the Sonde. Attach the 9-pin connector to a PC.
2. Start Hydras 3 LT. Wait for the software to scan for connected Sondes. Highlight the multiprobe and press **OPERATE SONDE**.

**Note:** If the Sonde appears to be connected and the software does not recognize the Sonde connection, remove and replace the connector cable and press **RE-SCAN FOR SONDE**. Repeat until Hydras 3 LT recognizes the Sonde.

3. Click on the Calibration Tab and click on the parameter to be calibrated.
4. Enter the calibration values and click **CALIBRATE**.

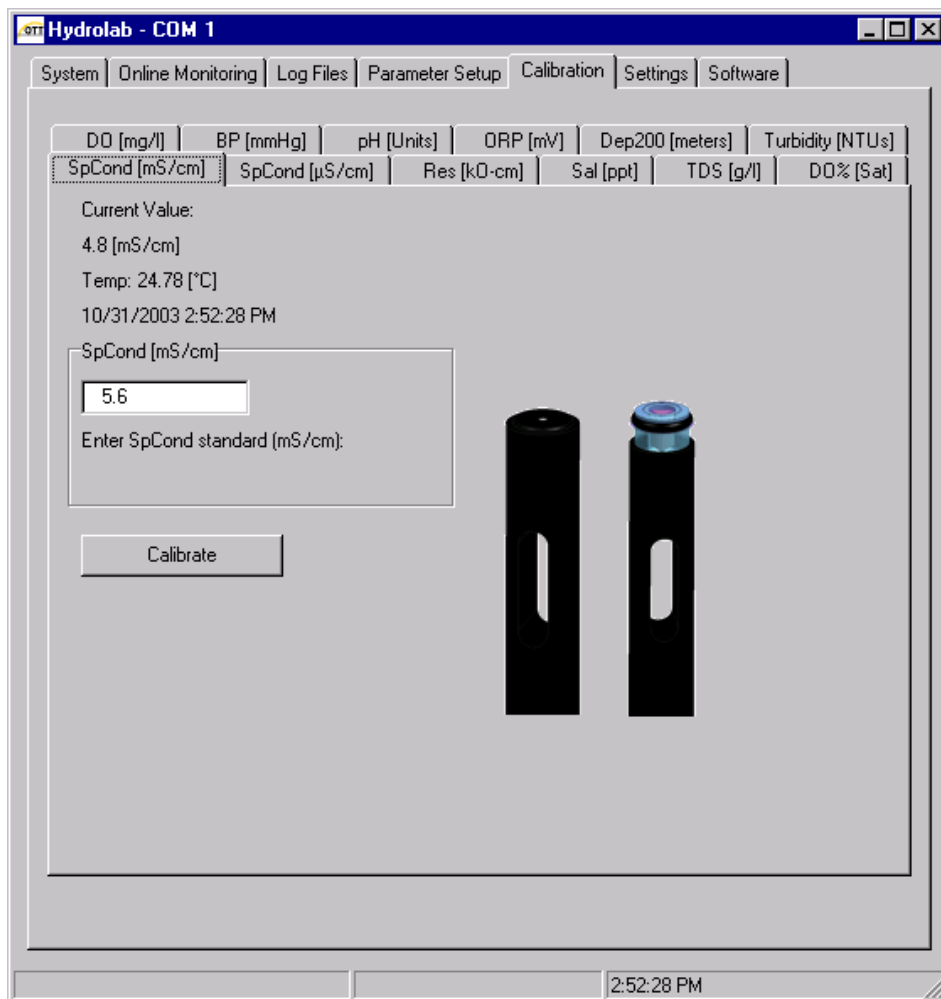

## 4.2.3 Calibration Preparation

The following is a general outline of the steps required to calibrate all the sensors.

- Select a calibration standard whose value is near the field samples.
- Clean and prepare the sensors.
- To ensure accuracy of calibration, discard used calibration standards appropriately. Do not reuse calibration standards.

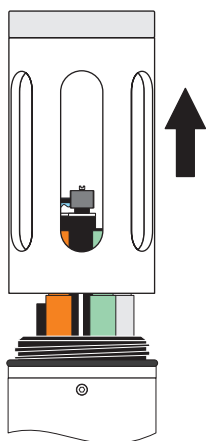

1. Remove Sensor Guard.

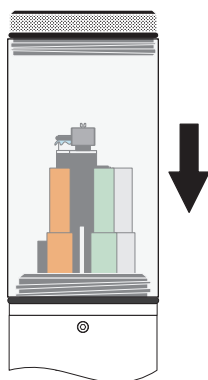

2. Attach the Calibration Cup.

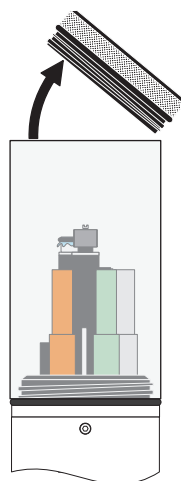

3. Unscrew and remove the cap from the Calibration Cup.

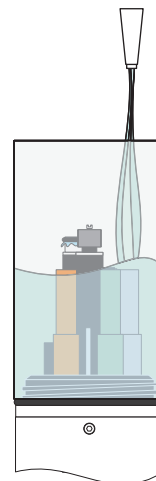

4. Fill the Calibration Cup half-full with deionized water.

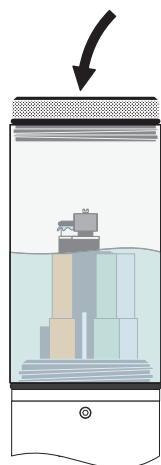

5. Place the Cap on the Calibration Cup.

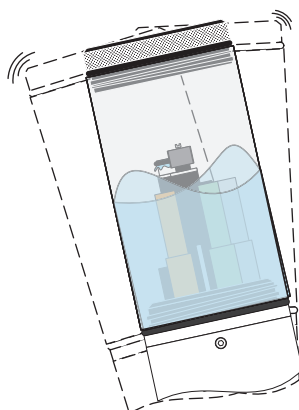

6. Shake the Sonde to make sure each sensor is free from contaminants that might alter the calibration standard. Repeat several times.

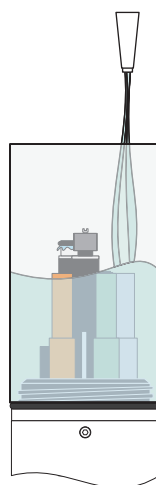

7. In a similar manner, rinse the sensors twice with a small portion of the calibration standard, each time discarding the rinse.

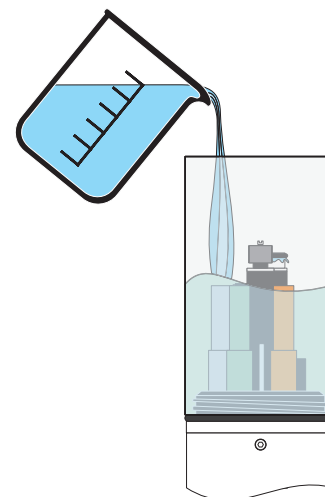

8. Complete the calibration.



## 4.2.4 Temperature Sensor Calibration

The temperature sensor is factory-set and does not require recalibration.

## 4.2.5 Specific Conductance Calibration

**Note:** TDS measurements are based on specific conductance and a user-defined scale factor. The factory default scale is 0.64 g/L / mS/cm.

This procedure calibrates TDS, raw Conductivity, and Salinity. Specific conductance requires a two-point calibration. Calibrate the sensor to zero and then to the slope buffer.

1. Pour the specific conductance standard to within a centimeter of the top of the Calibration Cup.
2. Make sure there are no bubbles in the measurement cell of the specific conductance sensor.
3. Enter the SpCond standard for mS/cm or  $\mu$ S/cm using Hydras 3 LT software or a Surveyor.

## 4.2.6 Clark Cell Dissolved Oxygen Sensor Calibration

Dissolved oxygen calibrations can be performed using water-saturated air or using a water sample with a known dissolved oxygen concentration.

**Note:** Dissolved oxygen can also be calibrated in a well stirred bucket of temperature-stable, air-saturated water. This situation resembles the actual field measurement conditions, but is more difficult to accomplish reliably.

### 4.2.6.1 Water-Saturated Air Dissolved Oxygen Calibration

#### **CAUTION**

**The saturated-air method is valid only for the Clark Cell dissolved oxygen sensor. If calibrating the Hach LDO sensor, refer to the Hach LDO Instruction Sheet (Cat. No. 00745589).**

**Note:** Calibration of D.O. % Saturation also calibrates D.O. mg/L.

1. Fill the Calibration Cup with deionized or tap water (specific conductance less than 0.5 mS/cm) until the water is just below the membrane O-ring. Do not allow water to contact the membrane or the O-ring.
2. Carefully remove any water droplets from the membrane with the corner of a tissue.
3. Turn the black cap upside down (concave upward) and lay it over the top of the Calibration Cup. This stops the exchange of air and allows the local environment to equilibrate. Wait for the reading to stabilize.
4. Determine the true barometric pressure for entry as the calibration standard. Barometric pressure information can be obtained from a local weather station or airport or the Surveyor (if equipped with BP). Some facilities calibrate BP at sea level, an elevation correction will need to be made.

**Local Barometric Pressure, BP, in mmHG can be estimated using:**

$$BP' = 760 - 2.5(A_{ft}/100) \quad \text{or} \quad BP' = 760 - 2.5(A_m/30.5)$$

where:

BP' = Barometric Pressure at altitude

BP = Barometric Pressure at sea level

A<sub>ft</sub> = Altitude in feet

A<sub>m</sub> = Altitude in meters

**If using the local weather bureau BP, remember these numbers are corrected to sea level. To calculate the uncorrected atmospheric pressure BP', use on the following equations:**

$$BP' = BP - 2.5(A_{ft}/100) \quad \text{or} \quad BP' = BP - 2.5(A_m/30.5)$$

where:

BP' = Barometric Pressure at altitude

BP = Barometric Pressure at sea level

A<sub>ft</sub> = Altitude in feet

A<sub>m</sub> = Altitude in meters

**Local barometric pressure in mbar (BPmbar) can be converted to local barometric pressure in mmHG (BPmmHg) using:**

$$BPmmHg = 0.75 \times BPmbar$$

5. Enter the barometric pressure in millimeters of Mercury (mmHg) at the site using Hydras 3 LT software or a Surveyor.

### 4.2.6.2 Known Concentration Dissolved Oxygen Calibration

**Note:** Calibration of D.O. mg/L also calibrates D.O. % Saturation.

1. Immerse the sensor in a water bath for which the D.O. concentration in mg/L is known (for instance, by Winkler titration). This calibration method is more difficult to perform than the saturated-air method but can yield a higher accuracy if the "known" D.O. concentration is highly accurate.
2. Enter the barometric units (mmHg) using Hydras 3 LT or a Surveyor.
3. Enter the D.O. units in mg/L using Hydras 3 LT or a Surveyor.

**Note:** If there is a change in barometric pressure after calibration (for instance, if barometric pressure drops as you move the calibrated Transmitter to a higher elevation for deployment), the readings for D.O. % Saturation will not be correct. You must enter a new barometric pressure. However, the readings for D.O. mg/L will be correct regardless of changes in barometric pressure.

## 4.2.7 Pressure Sensor Calibration

**Note:** The density of water varies with specific conductance. Pressure readings are corrected for specific conductance.

1. Remove water from the calibration cup.
2. Point sensors down.
3. Enter zero for the standard using Hydras 3 LT or a Surveyor.

## 4.2.8 pH/ORP Calibration

1. Pour the pH or ORP standard to within a centimeter of the top of the cup.
2. Enter the units for pH or ORP using Hydras 3 LT or a Surveyor.

**Note:** pH is a two-point or three-point calibration. A pH standard between 6.8 and 7.2 is treated as the “zero” and all other values are treated as the “slope”. First calibrate “zero”, then calibrate “slope”.

After the sensors have been properly maintained, the sensors can be calibrated. Always allow sufficient time for thermal stabilization of the standards. To reduce the time for stabilization, try to keep all calibration standards and equipment stored at the same temperature before parameter calibration. Always use fresh standard and do not tamper with standards.

## 4.2.9 Other Sensor Calibrations

Refer to the sensor specific instruction sheet for more information.

## 4.3 Using the DS5/MS5 for Short Term Deployments

### 4.3.1 Gathering Data Using the Surveyor

Refer to the Surveyor Manual (Cat. No. 003070).

### 4.3.2 Gathering Data Using a PC and Hydras 3 LT

For online monitoring and real-time monitoring information, refer to the Hydras 3 LT Quick Start Guide (Cat. No. 6234289).

### 4.3.3 Using the DS5/DS5X/MS5 for Unattended Monitoring

#### 4.3.3.1 Creating Log Files

**Note:** A log file must be created and then enabled before data can be collected.

1. Connect the Data Cable to a computer and to the Sonde.
2. Start Hydras 3 LT. The software will automatically scan for Sondes. All detected Sondes are displayed in the ‘Connected Sondes’ list in the Main window displayed below. If a Sonde is not found, reattach the data cable and press **RE-SCAN FOR SONDES**. Retry until the Sonde(s) are found.
3. Click on the Log Files tab.
4. Click the **CREATE** button.

5. Enter the name for the new log file. The empty log file is now created.
6. Enter the start and end time of the logging, the logging interval, the sensor warm-up time before logging, and how long before logging the circulator will be turned on, and if audio signals will be used while logging.
7. Select the parameters in the 'Parameter in Sonde' list and click the **ADD** button to place them into the 'Parameters in log file' list. Change the order of the parameters using the **ARROW** buttons.
8. Click **UPDATE SETTING** to send the configuration to the Sonde.
9. Click **ENABLE** to start collecting data. Click **DISABLE** to stop collecting data during logging. A fully completed logging run will automatically disable at the end of the run.
10. Click **DOWNLOAD** to download and display the log file. Select Printable or Spreadsheet format.

*Note: To delete a log file, select the log file in the Log File drop-down menu and click the **DELETE** button.*

### 4.3.3.2 Downloading Log Files

After a log file is created in the Log Files tab, the files can be downloaded by checking the appropriate Log File box and clicking **DOWNLOAD SELECTED FILES**. Multiple files can be downloaded at once. The downloaded log files are stored in the 'LogFiles' subdirectory of the HYDRAS 3 LT directory on the hard drive.

**Appendix C: Standard Operating Procedures / Quality Assurance Manual for Surface Water and Seep/Spring Sampling**

Pinto Valley Mining Corp.



**ARIZONA POLLUTANT DISCHARGE  
ELIMINATION SYSTEM  
(AZPDES)**

**PERMIT NUMBER AZ0020401  
QUALITY ASSURANCE MANUAL**

**APPENDIX C**

**STANDARD OPERATING PROCEDURES**

**JULY 30, 2019**

## TABLE OF CONTENTS

Section	Page
ACRONYMS AND ABBREVIATIONS .....	iii
1. 0 FIELD WATER QUALITY PARAMETER MEASUREMENTS.....	1
1.1 GENERAL STATEMENT .....	1
1.2 OBJECTIVE .....	1
1.3 EQUIPMENT AND/OR INSTRUMENTATION.....	1
1.4 PREPARATION .....	2
1.5 PROCEDURES .....	5
1.6 EQUIPMENT DECONTAMINATION AND WASTE DISPOSAL .....	6
1.7 DOCUMENTATION .....	6
1.8 QUALITY ASSURANCE.....	7
2. 0 SURFACE WATER SAMPLE COLLECTION .....	8
2.1 GENERAL STATEMENT .....	8
2.2 OBJECTIVES .....	8
2.3 EQUIPMENT AND/OR INSTRUMENTATION.....	8
2.4 PREPARATION .....	8
2.5 PROCEDURES .....	9
2.6 LOW LEVEL MERCURY SAMPLING.....	12
2.7 SAMPLE CONTAINERS, PRESERVATION, AND TRANSMITTAL.....	15
2.8 EQUIPMENT DECONTAMINATION AND DISPOSAL .....	15
2.9 DOCUMENTATION .....	16
2.10 QUALITY ASSURANCE.....	19

TABLE OF CONTENTS (continued)

**TABLES**

1	FIELD METER CALIBRATION FORM
2	SURFACE WATER FIELD SAMPLING FORM
3	FLOW DATA REPORT FORM

**FIGURES**

1	SAMPLE IDENTIFICATION LABEL
---	-----------------------------



## ACRONYMS AND ABBREVIATIONS

AZPDES	Arizona Pollutant Discharge Elimination System
DO	Dissolved Oxygen
EC	Electrical Conductivity
gpm	Gallon(s) per minute
ml	Milliliter
NTU	Nephelometric turbidity unit
QA	Quality Assurance
QC	Quality Control
SOP(s)	Standard Operating Procedure(s)
uMHOS/cm	Micromhos per centimeter

**APPENDIX C**  
**STANDARD OPERATING PROCEDURES**

**1.0 FIELD WATER QUALITY PARAMETER MEASUREMENTS**

**1.1 GENERAL STATEMENT**

Prior to collecting surface water samples for laboratory analysis, the field water quality parameters, electrical conductivity (EC), pH, dissolved oxygen (DO), and temperature, will be measured in water samples at each outfall, ambient monitoring point, and spring and seep monitoring location.

**1.2 OBJECTIVE**

Water quality parameters will be measured in accordance with Arizona Pollutant Discharge Elimination System (AZPDES) Permit AZ0020401 Parts I.A & 4.B. Water quality parameter data collected as part of AZPDES monitoring may be used for additional U.S. Environmental Protection Agency (EPA) EPA and/or Arizona Department of Environmental Quality (ADEQ) directed investigations and internal investigations.

**1.3 EQUIPMENT AND/OR INSTRUMENTATION**

Field equipment consists of an Oakton Series 10 to measure pH, temperature, and conductivity, and an Oakton DO 6+, which measures dissolved oxygen. An NIST field thermometer is utilized to measure water temperature. The meter probes will be submerged directly into the stream flow to a depth of ½ the channel depth for parameter measurements.

**Pinto Valley Mine**  
**AZPDES AZ0020401**  
**Quality Assurance Manual**  
**App. C – Standard Operating Procedures**

1.4 PREPARATION

The meters, thermometers, and any field sampling containers used to collect the sample will be thoroughly rinsed with distilled water prior to and after each use. All meters will be cleaned, stored, calibrated, and used pursuant to the manufactures recommendations. Calibration data will be recorded in the field meter calibration forms (Table 1).

Meter calibration is performed using the procedures provided in each equipments instruction manual. Calibration is performed in the office prior to mobilizing to each sampling site. A calibration cup is used to encapsulate the probes. To calibrate, attach the calibration cup to the unit. Fill the calibration cup half full with deionized water. Replace the cup. Swirl the water to “wash” the sensors. Discard the deionized water and repeat for a total of 3 rinses. In a similar manner, using a small amount of calibration solution, “wash” the sensors with the calibration solution a total of two times, each time discarding the rinse calibration solution. To ensure accuracy of calibration, discard used calibration standards. Do not reuse calibration standards. Make sure the calibration standards are current and have not expired based on the expiration date.

The pH meter will be “zeroed” at the pH standard which is in the range of the expected source water pH. Normally this is the 7.0 pH standard solution. First calibrate the “zero” at this pH standard, then calibrate the slope at pH 4 and pH 10 buffer solutions prior to commencing field work each day. Finally, perform a final verification check of the pH 7 buffer solution. The pH values of these standards are expected to bracket the range of pH in surface water samples collected at the site.

The electrical conductivity (EC) meter will be calibrated prior to commencing fieldwork each day. The EC meter will be calibrated using a standard calibration solution selected to bracket the range of conductivity expected in surface water samples collected at the site.

**Pinto Valley Mine**  
**AZPDES AZ0020401**  
**Quality Assurance Manual**  
**App. C – Standard Operating Procedures**

The dissolved oxygen (DO) meter will be inspected and calibrated each day prior to commencing sample collection. It is recommended the DO probe membrane and o-ring be replaced once every year with a pre-assembled cap. To replace the cap, unscrew the cap counterclockwise from the probe using the replacement tool. Rinse the probe under running water. Remove the old cap with the membrane and o-ring and replace with a new pre-assembled cap. Inject fill solution into the probe body through one of the 4 holes surrounding the silver cathode until fill solution leaks out from the fill hole (approximately 5 ml). Screw the new cap back into place. Allow at least one hour for the electrode to equilibrate before use.

Dissolved oxygen levels vary with temperature, atmospheric pressure, and salinity. Therefore, it is important to set the proper temperature, barometric pressure, and salinity values prior to performing any DO calibration or measurement.

The meter should be calibrated by the Pinto Valley Environmental Technicians in a controlled temperature environment, such as the air-conditioned sample shed, prior to each sampling event using the procedure detailed in the Oakton DO 6+ manual. Proper calibration includes inputting current barometric pressure first. This can be obtained from the flight crew at the Heli-pad immediately prior to calibration. Check the pressure reading by pressing MODE to display mg/L concentration. Press ON/OFF to power off. With the meter off, keep the MODE key pressed. Press and release ON/OFF, then release MODE. The meter should display “Set.P” after ON/OFF is released AND “COF.1” after mode is released. Press UP/DOWN arrows until the display shows DPr.7. Press HOLD/ENTER. The display will show the current setting, in either A.HG (millimeters of mercury) or “A.PA”. (kilopascal). Use UP/DOWN to select A.HG, then press HOLD/ENTER to confirm. Use UP/DOWN to set the actual pressure and press HOLD/ENTER to confirm.

The temperature reading of the meter should also be checked before use to ensure it is accurate. The temperature sensor is factory calibrated, however, it can be recalibrated if it is

**Pinto Valley Mine**  
**AZPDES AZ0020401**  
**Quality Assurance Manual**  
**App. C – Standard Operating Procedures**

not reading accurately. To calibrate temperature, press MODE to select temperature mode. The display should show a “T” for temperature and “A” for automatic temperature compensation. Dip the probe into a solution with known, accurate temperature by measuring it with a NIST thermometer. Press CAL, then press UP or DOWN to adjust the reading to match the correct temperature value. Press HOLD/ENTER to confirm the calibration and return to measurement mode.

The meter should be calibrated to 100% oxygen saturation by rinsing the probe bulb with deionized water or rinse solution three times, then press MODE to select % saturation. Hold the probe in a downward position and wait for the readings to stabilize. Press CAL, then press HOLD/ENTER to confirm the calibration.

The same procedure should be followed for 0% oxygen saturation by using a zero percent oxygen solution. This solution should be obtained from an unopened pouch of a solution with a known zero percent oxygen content, such as sodium sulfide solution. Stir the probe gently to homogenize the sample and make sure that the sample is continuously flowing past the membrane sensor. Keep in mind that the sensor consumes oxygen so it is important to continuously refresh the solution exposed to the sensor. Follow the procedure above to calibrate to 0% oxygen.

Performing the 100% saturation calibration above will simultaneously calibrate the corresponding mg/L concentration. Therefore, additional mg/L calibration isn't required in most circumstances. However, the meter should be checked annually to confirm it is reading properly. Rinse the probe with deionized water or rinse solution three times. Select mg/L calibration from MODE, then place the probe tip into a solution of known D.O. concentration. Remember the sample must continuously flow past the membrane at a rate of 2 inches per second for an accurate reading. Press CAL then press UP or DOWN to adjust the reading to match the known oxygen concentration value. Press HOLD/ENTER to confirm the calibration.

**Pinto Valley Mine**  
**AZPDES AZ0020401**  
**Quality Assurance Manual**  
**App. C – Standard Operating Procedures**

Deposits or wrinkles on the membrane surface act as a barrier to oxygen diffusing through the membrane, so it should be inspected and cleaned as necessary after each use to ensure maximum reliability using the following procedure:

1. Flush the entire instrument with clean, fresh water. Use soapy water and a soft brush to clean the outside surfaces of the instrument.
2. Visually inspect and gently clean the membrane with optical tissue or a cotton swab with soapy water, then rinse with fresh water.

The field thermometer will be rinsed with distilled water prior to each use. The accuracy of the field thermometer will be determined by checking the measured reading against other thermometers.

### 1.5 PROCEDURES

Meter probes will be submerged directly into the stream flow to approximately ½ the channel depth. Alternately, the meter may be submerged into a container triple rinsed with sample water. However, measurements of field parameters such as dissolved oxygen will quickly deteriorate using this method. The parameters will be measured as follows:

- Immediately submerge the probes and thermometer into the stream flow (or sample container) and record measurements after they have stabilized. Record dissolved oxygen and pH first.
- Record all field measurements in the field notebook.

**Pinto Valley Mine**  
**AZPDES AZ0020401**  
**Quality Assurance Manual**  
**App. C– Standard Operating Procedures**

- Compare the present measurements to measurements taken during the previous sampling round, if available. If a discrepancy exists greater than can be expected for routine changes in surface water quality, repeat the process.
- After parameters are measured, rinse the thermometer and probes with deionized water.

**1.6 EQUIPMENT DECONTAMINATION AND WASTE DISPOSAL**

The probes used for measurement of field parameters will be decontaminated before and after each measurement by rinsing with deionized water. No waste products are expected to be generated as part of collecting field water quality measurements.

**1.7 DOCUMENTATION**

Calibration of the field meters will be documented on a separate form (Table 1). Final measurements of EC, pH, DO, and temperature will be recorded in the appropriate surface water sampling form (Table 2).

**Pinto Valley Mine**  
**AZPDES AZ0020401**  
**Quality Assurance Manual**  
**App. C – Standard Operating Procedures**

1.8 QUALITY ASSURANCE

Quality assurance (QA) of field water quality parameter measurements will be accomplished by following the procedures described in this standard operating procedure (SOP) and by following the equipment manufacturers' operating instructions. Temperature, DO, pH, and EC will be measured at each required sample location during each sampling event. Prior to measuring water quality parameters, field personnel will verify that the instruments are properly calibrated according to procedures specified by the manufacturer. Calibration documentation for each instrument will be maintained for reference purposes (Table 1). Dated reference solutions for pH, and EC will be prepared and used to properly calibrate the instrument. The calibration of the pH meter and conductivity meter will be checked prior to the start of each day.

Field water quality parameter data obtained will be compared to previous data and examined for variations. If variations greater than 10 percent exist that cannot be accounted for by changes in field conditions and/or instrument stabilization, the measurement instrument will be recalibrated and the measurements repeated. If large discrepancies exist from previous measurements, an alternative measuring device may be used to verify the data.

Variance shall be measured by calculating the relative percent difference (RPD) of the most current previous reading and the current reading. The formula for calculating the RPD is:

$$RPD = \frac{(RC - RP)}{(RC + RP)/2} \times 100$$

Where RC = Current Reading, RP = Previous Reading, and RPD = Relative Percent Difference.



**Pinto Valley Mine  
AZPDES AZ0020401  
Quality Assurance Manual  
App. C – Standard Operating Procedures**

**2.0 SURFACE WATER SAMPLE COLLECTION**

**2.1 GENERAL STATEMENT**

Surface water samples will be conducted in accordance with the AZPDES permit. Measurable surface water is defined as any flow greater than 1 gallon per minute (gpm). The flow will be measured with a calibrated bucket and a stopwatch and the results recorded in the field logbook. It will be noted in the field book where flow is less than 1 gpm and no sample will be collected.

**2.2 OBJECTIVES**

The objective of surface water sample collection is to comply with the provisions of the AZPDES permit. Data collected as part of AZPDES monitoring may be used for additional EPA and/or ADEQ directed investigations and internal investigations.

**2.3 EQUIPMENT AND/OR INSTRUMENTATION**

Sample containers required for collection of water samples for chemical analysis are specified in (Tables 2, 3, 4, and 5 of the Quality Assurance Manual). Surface water sample equipment includes glass or HDPE transfer containers and hand pumps.

**2.4 PREPARATION**

Prior to commencing the sampling event, the following information will be determined and reviewed with all field personnel:

**Pinto Valley Mine**  
**AZPDES AZ0020401**  
**Quality Assurance Manual**  
**App. C – Standard Operating Procedures**

- objective of surface water sampling;
- analytical schedule;
- laboratory selected for analysis of samples; and
- Quality control (QC) samples required to accomplish objective.

The following procedures will be used during preparation for surface water sample collection:

- Review project objectives, sampling location, sampling procedures, preservation, special handling requirements, packaging, shipping, analytical parameters and detection limits, and sampling schedule with all personnel.
- Review health and safety procedures with field personnel.
- Inform laboratory of expected sample shipment.

## 2.5 PROCEDURES

The following procedures will be used for collection of surface water samples:

- Locate the established sample location and evaluate surface water conditions, as follows:
- If flow is less than 1 gpm as measured by a calibrated bucket and stopwatch, a sample will not be collected. The field sampling form will indicate that the flow rate was less than 1 gpm and a surface water sample was not collected.
- If there is surface water observed and it is safe and feasible to collect sample by hand-lowering or using a surface water sample rod, follow the procedures outlined below.
- While facing upstream, hand-lower sample container or decontaminated transfer jar into surface water to approximately ½ the channel depth. If unable to collect surface water sample by hand-lowering the sample container into the surface water, then a 5-foot rod will be used to extend the sample container into the surface water.

**Pinto Valley Mine**  
**AZPDES AZ0020401**  
**Quality Assurance Manual**  
**App. C– Standard Operating Procedures**

- Fill containers as appropriate.
- Collect surface water samples for total recoverable metals analysis in a decontaminated 500-milliliter (ml) or one liter high density polyethylene or glass transfer container. Pour sample from transfer container into acid-preserved laboratory supplied sample container. Alternately, if the sample containers are unpreserved, fill the laboratory supplied sample container to the neck with sample, then pour in 5 ml of lab supplied nitric acid. Store on ice in an ice chest immediately after collection.
- Collect surface water samples for dissolved metals analysis in one decontaminated 500-ml high density polyethylene bottle. Sample water will be field filtered with a 0.45 micron filter prior to filling the sample bottle. Field filter in the controlled environment of the sample shed using the peristaltic pump and store on ice in an ice chest immediately after collection or in a refrigerator chilled to 4°C.
- Collect one 1-liter non-preserved high density polyethylene bottle for general chemistry analysis. Triple rinse the sample bottle with sample water prior to filling the sample bottle. Store on ice in an ice chest immediately after collection.
- Collect surface water samples for low-level mercury analysis by following the specific procedures and protocol outlined in Section 2.6 below. Failure to follow these protocols may result in invalid or inaccurate mercury results. In particular, due to the high sensitivity of the analytical method, the lab may detect mercury in the sample which is not representative of actual surface water concentrations due to cross contamination of the sample.
- Collect one field duplicate sample for 10 percent (1 for every ten samples) of all samples collected during the sampling event. Duplicate samples should be collected by filling a

**Pinto Valley Mine**  
**AZPDES AZ0020401**  
**Quality Assurance Manual**  
**App. C – Standard Operating**  
**Procedures**

second set of sample bottles from the initial transfer container grab sample. If the transfer container is not large enough to fill all containers, fill both the original and duplicate sample containers of the same analysis type before moving on to another analysis type. Analyze duplicate samples for the same parameters as the original sample. Send duplicate samples along with the original samples to the primary laboratory. The location for duplicate sample collection will be determined prior to each sampling round. Handle duplicate water samples in a manner identical to other water samples.

Collect one field blank for each sampling event by obtaining laboratory supplied contaminant free water. Wear PPE to handle the containers in the same manner as the other sample containers. Open the water and transfer it into laboratory supplied sample containers at one of the sampling sites. Close the containers, and label and package in the same manner as the other sample containers. Submit to the lab in the same cooler as the other samples.

- Record the following information on the appropriate field sampling form (Table 2):
  - field water quality parameters including pH, EC, DO, and temperature;
  - time of sample collection;
  - surface water flow conditions including flow rate, approximate depth and width of flow, to the extent this can be determined, based on visual observations;
  - physical characteristics of the water sample including color and odor.
  - weather conditions including air temperature, an approximation of wind speed and wind direction, and overall conditions.
  
- Attach labels to sample containers immediately after samples are collected.

**Pinto Valley Mine**  
**AZPDES AZ0020401**  
**Quality Assurance Manual**  
**App. C– Standard Operating Procedures**

- Record pertinent data concerning each original sample and duplicate sample on the appropriate field sampling form (Table 2).
- Record chain-of-custody documentation at each sample location prior to sampling at the next location.
- Prepare transmittal letter and finalize chain-of-custody documentation at the completion of each sampling event.
- Package, store on ice, and transport the samples to the laboratory at the conclusion of each sampling day. Samples will be delivered to the laboratories each day.

**2.6 LOW LEVEL MERCURY SAMPLING**

Low level mercury sampling and analysis must be performed in order to obtain data capable of meeting the Permit Limit of 0.01 micrograms per liter ( $\mu\text{g/L}$ , or parts per billion) for mercury. Extreme care must be taken during all sampling operations to minimize exposure of the sample to human, atmospheric, and other sources of contamination. Care must be taken to avoid breathing directly on the sample (due to exhalation introducing cross-contamination from mercury fillings), and whenever possible, the sample bottle should be opened, filled, and closed while submerged. The sampler should face and sample in an upstream manner, taking extreme care not to agitate the water or disturb sediments in the water.

Samples must be collected using the “clean hands-dirty hands” technique. Upon arrival at the sampling site, one member of the two-person sampling team is designated as “dirty hands”; the second member is designated as “clean hands”. All operations involving contact with the sample bottle and transfer of the sample from the sample collection device to the sample bottle are

**Pinto Valley Mine**  
**AZPDES AZ0020401**  
**Quality Assurance Manual**  
**App. C – Standard Operating Procedures**

handled by the individual designated as “clean hands”. “ Dirty hands” is responsible for preparation of the sampler (except the sample container), operation of any machinery, and for all other activities that do not involve direct contact with the sample.

At the site, all sampling personnel must put on a nylon long sleeve wind suit or a Tyvek suit before sampling. Cotton or other materials may absorb mercury during the work shift and must be covered up by the suits. “Clean hands” puts on shoulder-length polyethylene gloves and both “clean hands” and “dirty hands” put on PVC gloves.

The “dirty-hands” sampler opens the cooler containing the sample bottle and unzips the outer bag containing the mercury sample container. Containers will be either a fluoropolymer that has been cleaned, tested, and double bagged in a Class-100 clean bench or borosilicate glass with fluoropolymer-lined lids obtained from a supplier that certifies cleanliness for metals sampling (e.g., I-Chem, Series 200). “Clean hands” must reach into the outer bag, open the inner bag, remove the bottle, and reseal the inner bag. “Dirty hands” then reseals the outer bag.

“Clean hands” unscrews the cap and, while holding the cap upside down, discards the dilute acid solution in the bottle into the stream. This acid solution is not a preservative, it is meant to ensure that the bottle remains mercury free during transport.

While holding the sample container upwind of the sampler, if possible, “clean hands” then submerges the sample bottle, and allows the bottle to partially fill with sample. “Clean hands” screws the cap on the bottle, shakes the bottle several times, and empties the rinsate away from the sampling point. After two more rinsings, “clean hands” holds the bottle under water and allows the bottle to fill with sample. After the bottle has filled (i.e., when no more bubbles appear), and while the bottle is still inverted so that the mouth of the bottle is underwater, “clean hands” replaces the cap of the bottle.

**Pinto Valley Mine**  
**AZPDES AZ0020401**  
**Quality Assurance Manual**  
**App. C– Standard Operating Procedures**

It is preferable to ship the samples unpreserved if they can be preserved by the analytical laboratory. Samples may be shipped unpreserved if they are:

- 1) Collected in the specified borosilicate glass or fluoropolymer bottles;
- 2) Filled to the top with no head space;
- 3) Tightly capped, and;
- 4) Maintained at 0-4 degrees Celsius from the time of collection until preservation.

Samples must be preserved within 48 hours after sampling. Therefore, if shipments cannot be made in time for the lab to preserve the samples, samples must be preserved by the following method:

Immediately after filling bottle with sample using the methods described above, “clean hands” removes acid preservative from bag it was supplied in by touching only the inside of the bag and pours a small amount of sample out of the sample container to allow for acid preservative. “Clean hands” pours 5 ml per liter of pretested high purity 12N hydrochloric acid or 5 ml/L BrCl into sample bottle and immediately caps and packages in manner described above. “Clean hands” places the acid preservative back into the bag it was supplied in.

Once the bottle lid has been replaced, “dirty hands” reopens the outer plastic bag, and “clean hands” opens the inside bag, places the bottle inside it, and zips the inner bag.

“Dirty hands” zips the outer bag and places the sample identification label on the outside of the outer bag. Cover the label with clear packing tape to ensure it does not fall off. Place the container inside of a double-lined sample cooler. The samples should be placed inside of a heavy duty plastic liner, which is surrounded with wet ice contained within another heavy duty plastic liner so the cooler does not leak. After all samples are collected the interior liner is sealed with Zip-ties, then the exterior liner is sealed with Zip-ties.

**Pinto Valley Mine**  
**AZPDES AZ0020401**  
**Quality Assurance Manual**  
**App. C– Standard Operating Procedures**

After each sample is collected, the sample is documented in the sample log, and any unusual observations concerning the sample and the sampling are documented.

A field blank should be collected with every 10 samples from a given site. The field blank is collected by the following method:

To collect the field blank, open an empty sample bottle using the “Clean hands” “Dirty hands” techniques described above. Also open the bottle containing the reagent water supplied by the lab. Pour the reagent water into the empty sample bottle. This is now the field blank.

Re-bag the field blank in the opposite order it was removed. Label the outside bag with the sample identification information and place into the cooler on wet ice.

#### 2.7 SAMPLE CONTAINERS, PRESERVATION, AND SHIPPING

Upon collection, all samples except the mercury containers will be labeled and stored on ice in ice chests until received by the laboratory. Custody seals should be applied to the cooler lid and taped into place with clear tape. Sample shipments will contain completed transmittal letter and chain-of-custody records stored in sealed plastic bags for shipment to the laboratory. Each ice chest containing samples will be clearly labeled and sealed to prevent tampering.

#### 2.8 EQUIPMENT DECONTAMINATION AND DISPOSAL

Decontamination is not necessary for containers provided by the laboratory. Sample containers not pretreated with preservatives in the laboratory will be triple rinsed with sample water prior to collecting the surface water sample. Preserved, pre-treated sample containers will not be triple rinsed. These containers will be filled once and immediately secured. If non-dedicated transfer containers are used, the transfer jars will be decontaminated by using a nylon brush in a non-phosphate detergent wash, followed by a tap water rinse, a distilled water rinse, and triple rinse with sample water prior to collection.



**Pinto Valley Mine**  
**AZPDES AZ0020401**  
**Quality Assurance Manual**  
**App. C – Standard Operating Procedures**

2.9 DOCUMENTATION

In accordance with AZPDES permit Part II D, the Permittee shall retain records of all monitoring information, including:

- i. The date, exact place, and time of sampling or measurements,
- ii. The individual who performed the sampling or measurements;
- iii. The date(s) the analyses were performed;
- iv. The individual who performed the analyses;
- v. The analytical techniques or methods used; and
- vi. The results of such analyses.

A running log of field activities should be recorded in a field notebook, including a record of significant events, observations, measurements, personnel, site conditions, sampling procedures, measurement procedures, and calibration records. This should include documenting “weather conditions, sampling point identification, type of QA/QC samples (i.e. blank(s)) collected and method of collection, field measurements, and condition, color, and characteristics of water and sediments in the stream bed and banks.

These entries should also include the following information;

- Date, Time, and Location of Sampling;
- Sample Identifications and locations;
- Condition of sample site relevant to sample validity;
- Purpose for Sampling;
- Start and Finish Times;
- Names and Titles of Samplers;
- Safety Equipment (if any);
- Sampling Equipment;
- Containers, Volumes, Preservation Methods and Holding Times;

**Pinto Valley Mine**  
**AZPDES AZ0020401**  
**Quality Assurance Manual**  
**App. C– Standard Operating Procedures**

- Analysis Required;
- Weather Conditions;
- Details of Fieldwork Performed;
- Personnel and Equipment Decontamination Procedures.

All entries of field data in the field notebook will be signed, dated, and kept as a permanent record. Crossing a line through the error and entering the correct information will correct erroneous entries. Field sampling personnel making the re-entry will initial corrections.

Sample identification documents will be prepared so that sample identification and chain-of-custody are maintained and sample disposition controlled. Sample identification documents include sample identification labels and chain-of-custody records.

Standard sample identification labels and chain-of-custody documents will be used to record all information. Forms and labels will be completed with waterproof ink. The sample documentation forms accompany the samples to the laboratory. Copies of the sample documentation forms will be retained by the samplers and sent directly to the Project and QA/QC Manager.

Field personnel will secure adhesive sample labels to the sample containers (Figure 1). The following information will be recorded on the sample label:

- sample location/identifier;
- date and time sample was collected;
- analyses to be performed;
- chemical preservative;
- project name or number;
- sampler's initials;

**Pinto Valley Mine**  
**AZPDES AZ0020401**  
**Quality Assurance Manual**  
**App. C– Standard Operating Procedures**

- any other pertinent information; and
- any special instructions to laboratory personnel.

The sample cooler will be secured with a signed and dated custody seal, which will be placed onto a taped surface and enveloped by clear tape to secure it.

Official custody of samples will be maintained and documented from the time of sample collection until the verification of analytical results. The chain-of-custody record is the document that records the transfer of sample custody. The chain-of-custody record also serves to cross-reference the sample identifier assigned by the Field Sampling Manager with the sample identifier assigned by the laboratory. The chain-of-custody record includes the following information:

- sample location/identifier;
- project name or number;
- sampling date;
- sampling personnel;
- shipping method and date;
- sample description;
- number of containers;
- sample destination;
- preservatives used;
- analyses to be performed;
- special handling and reporting procedures; and
- the identity of personnel relinquishing and accepting custody of the samples.

The sampling personnel will be responsible for the samples and will sign the chain-of-custody record to document sample transferral or transport. Samples will be packaged in sealed

**Pinto Valley Mine**  
**AZPDES AZ0020401**  
**Quality Assurance Manual**  
**App. C– Standard Operating Procedures**

containers for transport and dispatched to the appropriate laboratory for analysis with a separate transmittal letter and chain-of-custody record accompanying each shipment. The method of transport, courier name(s), and other pertinent information will be entered on the transmittal letter accompanying the samples. The chain-of-custody record will accompany the samples during transport.

Once received at the laboratory, laboratory custody procedures apply. It is the laboratory's responsibility to acknowledge receipt of samples and verify that the containers have not been opened or damaged. It is also the laboratory's responsibility to maintain custody and sample tracking records throughout sample preparation and analysis. A copy of the chain-of-custody record is then sent to the Project QA Manager.

#### 2.10 QUALITY ASSURANCE

QA for surface water samples will be accomplished by following the procedures described in this SOP and by monitoring laboratory QA procedures. In addition, the following field QC methods will be implemented during sample collection:

**Pinto Valley Mine**  
**AZPDES AZ0020401**  
**Quality Assurance Manual**  
**App. C – Standard Operating Procedures**

- Collect one field duplicate sample for 10 percent of all samples collected during the sampling event. Collect the field duplicate by filling a second set of sample bottles from the sample stream or the initial transfer container grab sample. If the transfer container is not large enough to fill all containers, fill both the original and duplicate sample containers of the same analysis type before moving on to another analysis type. Analyze duplicate samples for the same parameters as the original sample. Send duplicate samples along with original samples to the primary laboratory. The purpose of the duplicate sample is to determine the precision of field sampling and the ability of the laboratory in reproducing the sample result.
- Identify duplicate samples in the same manner as all other samples. Identifiers will be determined prior to the sampling round.
- Prior to the start of each sampling round, the Project QA Manager and Field Sampling Manager will determine the sampling location for duplicate sample collection. Additionally, the Field Sampling Manager will specify labeling procedures for all QC samples. This information will be contained in the field notebook issued to field sampling personnel prior to the start of sampling activities.

**Pinto Valley Mine**  
**AZPDES AZ0020401**  
**Quality Assurance Manual**  
**App. C – Standard Operating Procedures**

**EQUIPMENT FIELD LIST**

Logbook

Personnel Protective Equipment (Nitrile Gloves, safety glasses, hard hat, boots, etc)

NIST thermometers

Oakton pH/Con 10 meter

HACH HS-C Test Kit for hydrogen sulfide analysis

Oakton Series 10 dissolved oxygen meter

Calibration Standards (pH, conductivity, zero oxygen, etc)

Sample Location and Analyte List (Table 4)

Ice chest with ice and custody seals

Sample Kits (bottles)

Sample Labels

Packing Tape

Sharpies, pens, pencils

Deionized Water

0.45 micron filters

Flex Hose (disposable tubing)

NIST Thermometer

Stop Watch

Calibrated 5 gallon bucket

Backup pH and conductivity meters as necessary.

**Pinto Valley Mine  
AZPDES AZ0020401  
Quality Assurance Manual  
App. C- Standard Operating Procedures**

**FIGURES**



**LEGEND**

- PROPERTY PIPELINE
- PMVC PRIVATE LAND
- PROPERTY BOUNDARY UNPATENTED CLAIMS
- ROADS - PAVED
- ROADS - UNPAVED
- CONTAINMENT PIPELINE FOR AZPDES PERMIT #A20020401
- BURCH PIPELINE (INCLUDES WATER FROM DAMNOCK H PIT AND OLD DOMINION A-SHAFT)
- UNIMPACTED STORMWATER DIVERSION CHANNEL
- IMPACTED STORMWATER DIVERSION CHANNEL
- NON-DISCHARGING SURFACE WATER POND
- STORMWATER SEDIMENT CONTROL
- STORMWATER CULVERT (DISCHARGE)
- STORMWATER CULVERT (RETAINED)
- STORMWATER BERM (DISCHARGE)
- STORMWATER BERM (RETAINED)
- STORMWATER OUTFALL (NOT SAMPLED)
- STORMWATER OUTFALL (SAMPLED)
- BOUNDARY OUTLINE (DASHED OUTSIDE OF PROPERTY LINE)
- STORMWATER OUTFALL DRAINAGE AREA
- SEEP INSPECTION ZONE
- ACTIVE FACILITY OUTLINE
- INACTIVE FACILITY OUTLINE
- PEZ/DOMEZ
- NON-DISCHARGING SECTION OF TSF4 TAILINGS PIPELINE
- SHADING INDICATES NON-DISCHARGING BASIN
- SHADING INDICATES DISCHARGING STORMWATER BASIN WITH NO "STORMWATER INDUSTRIAL ACTIVITY BY CAPSTONE"
- ROCK ANCHOR
- OUTFALL & SEEPS FOR AZPDES PERMIT & APP PERMIT #A20020401
- APP MONITORING WELL
- EXPLORATION DRILL SITE
- IMPAIRED FOR SELENIUM AND NON-ATTAINING FOR COPPER
- NON-ATTAINING REACH FOR COPPER
- PEAK WELL
- RECEIVING WATERS SAMPLE LOCATION
- SPRING
- POWER POLE
- EPHEMERAL TRIBUTARY BACKGROUND SAMPLES

NO.	DESCRIPTION	DATE
1	BASE SWPPP	APR 05
2	MSGP 2010 STORMWATER UPDATE	MAY 11
3	FLOW PLAN FOR OVERVIEW UPDATE	FEB 12
4	MSGP 2010 STORMWATER UPDATE	JUNE 12
5	MSGP 2010 STORMWATER UPDATE	OCT 12
6	EXPLORATION AND CLAIM RECLAMATION	JAN 13
7	CHANGE OUTFALL SITE SMD 13 TO LOCATION	FEB 13
8	FLOW PLAN AND MILLER O&A CORRECTIONS	MAY 13
9	CHANGE OUTFALLS AND OPERATOR INFO	MAY 14
10	CHANGES	SEP 14
11	CHANGES	NOV 14
12	ADDED NEW TAILINGS PUMP STATION	OCT 15
13	BASE SWPPP UPDATE	MAR 17



**Pinto Valley Mine**

**Pinto Valley Mine  
APP, AZPDES & SWPPP  
Site Map**

DATE: June 2018 DRAWN BY: JF FIGURE: 1 REVISION NO: WRI

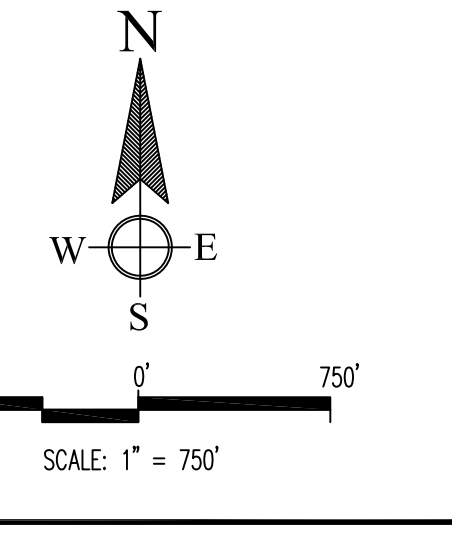



**Pinto Valley Mine  
 AZPDES AZ0020401  
 Quality Assurance Manual  
 App. C- Standard Operating Procedures**



**FIGURE 1 – SAMPLE IDENTIFICATION LABELS**

**Pinto Valley Mine  
AZPDES AZ0020401  
Quality Assurance Manual  
App. C– Standard Operating Procedures**

**TABLES**





**TABLE 3 Pinto Valley Mining Corp. - Surface Water Field Data (APP<sup>-</sup> & AZPDES<sup>+</sup>)**

Sample Quarter & Year \_\_\_\_\_

Sample Location ( <sup>-</sup> = APP, <sup>+</sup> = AZPDES)	North Draw 1 <sup>-</sup>	MG1-6b <sup>-</sup>	MG1-7a <sup>-</sup>	MG1-12b <sup>-+</sup>	MP0-1b <sup>+</sup>	MG2-8b <sup>+</sup>	002 <sup>+</sup>	003 <sup>+</sup>	004 <sup>+</sup>	005 <sup>+</sup>
Sampler's Initials										
Date										
Time										
Water Temperature (°F)										
pH (S.U.)										
Conductivity (umhos/cm)										
Dissolved Oxygen (mg/L)										
Flow (gpm)										
Air Temperature (°F)										
Weather Conditions										
Condition, Color, Characteristics of Water & Sediments in Stream Beds & Banks										
QA/QC Performed (Equip. Calibration, blanks, duplicates, etc.)										

S.U. = Standard Units UMHOS/CM = Micromhos per Centimeter °F = Degrees Fahrenheit mg/L = Milligrams per Liter  
GPM = Gallons per Minute

**TABLE 4 – AZPDES DISCHARGE FLOW RECORD**

Pinto Valley Mine – AZ0020401			
Discharge to Unnamed Wash to Pinto Creek in the Salt River Basin At:			
<b>Outfall No:</b>	002		
<b>Location:</b>			
<b>Month:</b>		<b>Year:</b>	
<b>Date:</b>	<b>Flow Duration <sup>(1)</sup> (Total hours per day)</b>	<b>Flow Rate <sup>(2)</sup> (Total MGD per day)</b>	
1			
2			
3			
4			
5			
6			
7			
8			
9			
10			
11			
12			
13			
14			
15			
16			
17			
18			
19			
20			
21			
22			
23			
24			
25			
26			
27			
28			
29			
30			
31			
<b>Comment:</b>			

**Footnotes**

- 1 Total time of discharge in hours per day. If actual time is not available, use an estimate of flow duration.
- 2 Report flow discharge in MGD. If no discharge occurs on any given day, report 'ND' for the flow for that day.

**TABLE 4 – AZPDES DISCHARGE FLOW RECORD**

Pinto Valley Mine – AZ0020401			
Discharge to Unnamed Wash to Pinto Creek in the Salt River Basin At:			
<b>Outfall No:</b>	003		
<b>Location:</b>			
<b>Month:</b>		<b>Year:</b>	
<b>Date:</b>	<b>Flow Duration <sup>(1)</sup> (Total hours per day)</b>	<b>Flow Rate <sup>(2)</sup> (Total MGD per day)</b>	
1			
2			
3			
4			
5			
6			
7			
8			
9			
10			
11			
12			
13			
14			
15			
16			
17			
18			
19			
20			
21			
22			
23			
24			
25			
26			
27			
28			
29			
30			
31			
<b>Comment:</b>			

**Footnotes**

- 1 Total time of discharge in hours per day. If actual time is not available, use an estimate of flow duration.
- 2 Report flow discharge in MGD. If no discharge occurs on any given day, report 'ND' for the flow for that day.

**TABLE 4 – AZPDES DISCHARGE FLOW RECORD**

Pinto Valley Mine – AZ0020401			
Discharge to Unnamed Wash to Pinto Creek in the Salt River Basin At:			
<b>Outfall No:</b>	004		
<b>Location:</b>			
<b>Month:</b>		<b>Year:</b>	
<b>Date:</b>	<b>Flow Duration <sup>(1)</sup> (Total hours per day)</b>	<b>Flow Rate <sup>(2)</sup> (Total MGD per day)</b>	
1			
2			
3			
4			
5			
6			
7			
8			
9			
10			
11			
12			
13			
14			
15			
16			
17			
18			
19			
20			
21			
22			
23			
24			
25			
26			
27			
28			
29			
30			
31			
<b>Comment:</b>			

**Footnotes**

1 Total time of discharge in hours per day. If actual time is not available, use an estimate of flow duration.

2 Report flow discharge in MGD. If no discharge occurs on any given day, report 'ND' for the flow for that day.



**TABLE 5 – FIELD SAMPLING GUIDE - OUTFALL 005 ANNUAL ANALYTE LIST**

**AZPDES Annual Sampling (ONCE/YEAR IN YEARS 2021, 2022, 2023 OF PERMIT  
PV005**

ANALYTE GROUP	LAB	COC Quote ID	EPA METHOD	SAMPLE CONTAINER	PRESERVATION METHOD	HOLDING TIME
<b>General Chemistry</b>						
Hardness (CaCO <sub>3</sub> )	SVL	AZPDES - Annual	SM2340B	500 ml Poly HNO <sub>3</sub>	Cool to 4°C	28 days
Total Dissolved Solids	SVL	AZPDES - Annual	SM2540C	500ml poly	Cool to 4°C	
<b>Total Recoverable Trace Metals</b>						
Antimony	SVL	AZPDES - Annual	200.8	500 mL poly	HNO <sub>3</sub> ; to pH <2 and cool to 4°C	6 months
Arsenic	SVL	AZPDES - Annual	200.8			
Beryllium	SVL	AZPDES - Annual	200.8			
Chromium (Total)	SVL	AZPDES - Annual	200.7			
Iron	SVL	AZPDES - Annual	200.7			
Nickel	SVL	AZPDES - Annual	200.7			
Silver	SVL	AZPDES - Annual	200.7			
Thallium	SVL	AZPDES - Annual	200.8			
<b>Dissolved Trace Metals</b>						
Chromium VI	Test America	Chrom VI	SM3500CrD	500 mL poly	Field Filter, Cool to 4°C	24 hours

Updated 7-29-2019

Test America COC: AZPDES-Chrom VI Dissolved (Field Filtered)

**TABLE 6 – FIELD SAMPLING GUIDE - OUTFALL 005 QUARTERLY ANALYTE LIST**

**AZPDES Quarterly Sampling  
PV005**

ANALYTE GROUP	LAB	COC Quote ID	EPA METHOD	SAMPLE CONTAINER	PRESERVATION METHOD	HOLDING TIME
<b>General Chemistry</b>						
Total Suspended Solids	SVL	AZPDES - Quarterly Metals/Gen Chem	SM2540D	500ml Poly	Cool to 4°C	7 days
Hardness (CaCO <sub>3</sub> )	SVL	AZPDES - Quarterly Metals/Gen Chem	SM2340B	500mL poly HNO3	Cool to 4°C	28 days
Discharge + Receiving Water Hardness (CaCO <sub>3</sub> )	SVL	AZPDES - Quarterly Metals/Gen Chem	SM2340B		Cool to 4°C	28 days

**Total Recoverable Trace Metals**

Cadmium	SVL	AZPDES - Quarterly Metals/Gen Chem	200.8	500 ml poly	HNO3; to pH <2 and cool to 4°C	6 months
Copper	SVL	AZPDES - Quarterly Metals/Gen Chem	200.8			
Iron	SVL	AZPDES - Quarterly Metals/Gen Chem	200.7			
Lead	SVL	AZPDES - Quarterly Metals/Gen Chem	200.8			
Selenium	SVL	AZPDES - Quarterly Metals/Gen Chem	200.8			
Thallium	SVL	AZPDES - Quarterly Metals/Gen Chem	200.8			
Zinc	SVL	AZPDES - Quarterly Metals/Gen Chem	200.7			
Low Level Mercury, Total Recoverable	Test America	Low Level Mercury	EPA 1631E	Mercury Bottles	Low Mercury, Cool to 4°C (unpreserved - must send to lab within 48 hours)	28 days

**Inorganics**

Cyanide	SVL	AZPDES - Quarterly Metals/Gen Chem	EPA 335.4	250ml poly	NaOH to pH >12, Cool to 4°C	14 days
Hydrogen Sulfide	Test America	AZPDES - Hydrogen Sulfide	SM4500-S2-H	250ml poly	Cool to 4°C	2 days
Sulfide - Low Level	Test America	AZPDES - Quarterly Metals/Gen Chem	SM4500-S2-D	1L. poly	1-Bottle, NaOH & Zinc Acetate, pH>12, Cool to 4°C	7 days

**Field Parameters**

Flow Rate (MGD)
pH (S.U.)

Updated 7-29-2019

Test America COC: AZPDES-Low-Level Mercury, Sulfide, and Hydrogen Sulfide

**TABLE 7 – FIELD SAMPLING GUIDE - MG1-12B QUARTERLY ANALYTE LIST**

**AZPDES and APP Quarterly Sampling  
Gold Gulch MG1-12b**

ANALYTE GROUP	Permit	LAB	COC ID	EPA METHOD NUMBER	SAMPLE CONTAINER	PRESERVATION METHOD	HOLDING TIME
---------------	--------	-----	--------	-------------------	------------------	---------------------	--------------

**General Chemistry**

Alkalinity (Total)	AZPDES	SVL	AZPDES - Seeps	SM2320B	500 ml poly	Cool to 4°C	14 days
Sulfate	AZPDES, APP	SVL	AZPDES - Seeps	300	500ml poly	Cool to 4°C	28 days
Total Dissolved Solids	AZPDES, APP	SVL	AZPDES - Seeps	SM2540C		Cool to 4°C	7 days
Total Suspended Solids	AZPDES	SVL	AZPDES - Seeps	SM2540D	500ml poly	Cool to 4°C	7 days
Hardness	AZPDES	SVL	AZPDES - Seeps	SM2340B	500mL poly HNO3	Cool to 4°C	28 days

**Total Recoverable Trace Metals**

Arsenic	AZPDES	SVL	AZPDES - Seeps	200.8	500 ml poly	HNO <sub>3</sub> ; to pH <2 and cool to 4°C	6 months
Beryllium	AZPDES	SVL	AZPDES - Seeps	200.8			
Cadmium	AZPDES	SVL	AZPDES - Seeps	200.8			
Chromium (Total)	AZPDES	SVL	AZPDES - Seeps	200.7			
Copper	AZPDES	SVL	AZPDES - Seeps	200.8			
Iron	AZPDES	SVL	AZPDES - Seeps	200.7			
Lead	AZPDES	SVL	AZPDES - Seeps	200.8			
Manganese	AZPDES	SVL	AZPDES - Seeps	200.7			
Nickel	AZPDES	SVL	AZPDES - Seeps	200.7			
Selenium	AZPDES	SVL	AZPDES - Seeps	200.8			
Zinc	AZPDES	SVL	AZPDES - Seeps	200.7			
Chromium VI	AZPDES	Test America	Chromium VI	SM3500-Cr-B			
Mercury - Low Level	AZPDES	Test America	Low Level Mercury, Total	1631E	Mercury Bottles	Low Mercury, Cool to 4°C (unpreserved - must send to lab within 48 hours)	28 days

**AZPDES and APP Quarterly Sampling  
Gold Gulch MG1-12b**

ANALYTE GROUP	Permit	LAB	COC ID	EPA METHOD NUMBER	SAMPLE CONTAINER	PRESERVATION METHOD	HOLDING TIME
<b>Dissolved Trace Metals</b>							
Antimony	APP	SVL	APP - Seep	200.8	500 ml poly, Field Filtered	HNO <sub>3</sub> ; to pH <2 and cool to 4°C	6 months
Arsenic	AZPDES, APP	SVL	AZPDES - Seeps	200.8			
Beryllium	AZPDES, APP	SVL	AZPDES - Seeps	200.8			
Cadmium	AZPDES, APP	SVL	AZPDES - Seeps	200.8			
Chromium (Total)	AZPDES, APP	SVL	AZPDES - Seeps	200.7			
Cobalt	APP	SVL	APP - Seep	200.7			
Copper	AZPDES, APP	SVL	AZPDES - Seeps	200.7			
Iron	AZPDES, APP	SVL	AZPDES - Seeps	200.7			
Lead	AZPDES, APP	SVL	AZPDES - Seeps	200.8			
Manganese	AZPDES, APP	SVL	AZPDES - Seeps	200.7			
Nickel	AZPDES, APP	SVL	AZPDES - Seeps	200.7			
Selenium	AZPDES, APP	SVL	AZPDES - Seeps	200.8			
Zinc	AZPDES, APP	SVL	AZPDES - Seeps	200.7			
Chromium VI	AZPDES	Test America	Chromium VI	SM3500CrD	500 mL Bottle, Field Filtered	Cool to 4°C	24 hrs
<u>Mercury - Low Level</u>	<u>AZPDES</u>	<u>Test America</u>	<u>Low Level Mercury, Dissolved</u>	<u>1631E</u>	<u>Mercury Bottles</u>	<u>Low Mercury Cool to 4°C (unpreserved - must send to lab within 48 hours)</u>	<u>28 days</u>

**Inorganics**

Cyanide, Total & Dissolved	AZPDES	SVL	AZPDES - Seeps	EPA 335.2	250 ml poly, 2-Bottles, 1-Field Filter,	NaOH to pH, >12, Cool to 4°C	14 Days
Flouride	APP	SVL	APP - Seep	EPA 300.0	Sample bottle used for Gen Chem	Cool to 4°C	28 days
Nitrate + Nitrite as N	APP	SVL	APP - Seep	353.2	250ml poly	H <sub>2</sub> SO <sub>4</sub> to pH <2, Cool to 4°C	28 Days

**Radiological**

Gross Alpha, Dissolved	APP	Test America	Gross Alpha, Dissolved	900	1 - 1L Poly, Field Filtered	HNO <sub>3</sub> to pH<2, Cool to 4°C	6 months
------------------------	-----	--------------	------------------------	-----	-----------------------------	---------------------------------------	----------

**Field Parameters**

Dissolved Oxygen (mg/L)	AZPDES	Field
Flow Rate (MGD)	AZPDES	Field
pH (S.U.)	AZPDES	Field
Specific Conductivity	AZPDES	Field
Temperature (°C)	AZPDES	Field

**SVL COC:** APP - Seep, AZPDES Seeps

**Test America COC:** AZPDES-Chrom VI Dissolved (Field Filtered); AZPDES-Chrom VI Total (Un-Filtered); Low Level Mercury Total; Low Level Mercury Dissolved, APP-Gross Alpha, Dissolved

Updated 7-29-2019

**TABLE 8 – FIELD SAMPLING GUIDE - MPO-1B AND MG2-88 QUARTERLY ANALYTE LIST**



**AZPDES Quarterly Sampling  
MG2-8b and MPO-1b**

ANALYTE GROUP	LAB	COC Quote ID	EPA METHOD NUMBER	SAMPLE CONTAINER	PRESERVATION METHOD	HOLDING TIME
<b>General Chemistry</b>						
Alkalinity (Total)	SVL	AZPDES - Seeps	SM2320B	500 ml poly	Cool to 4°C	14 days
Sulfate	SVL	AZPDES - Seeps	300	500 ml poly	Cool to 4°C	28 days
Total Dissolved Solids	SVL	AZPDES - Seeps	SM2540C		Cool to 4°C	7 days
Total Suspended Solids	SVL	AZPDES - Seeps	SM2540D	500ml poly	Cool to 4°C	7 days
Hardness	SVL	AZPDES - Seeps	SM2340B	500mL HDPE HNO3	Cool to 4°C	28 days
<b>Total Recoverable Trace Metals</b>						
Arsenic	SVL	AZPDES - Seeps	200.8	500 ml poly	HNO <sub>3</sub> ; to pH <2 and cool to 4°C	6 months
Beryllium	SVL	AZPDES - Seeps	200.8			
Cadmium	SVL	AZPDES - Seeps	200.8			
Chromium (Total)	SVL	AZPDES - Seeps	200.7			
Copper	SVL	AZPDES - Seeps	200.8			
Iron	SVL	AZPDES - Seeps	200.7			
Lead	SVL	AZPDES - Seeps	200.8			
Manganese	SVL	AZPDES - Seeps	200.7			
Nickel	SVL	AZPDES - Seeps	200.7			
Selenium	SVL	AZPDES - Seeps	200.8			
Zinc	SVL	AZPDES - Seeps	200.7			
Chromium VI	Test America	Chromium VI	SM3500-Cr-B	500 mL Bottle (unfiltered)	Cool to 4°C	<b>24 hrs</b>
<u>Mercury - Low Level</u>	<u>Test America</u>	<u>Low Level Mercury</u>	<u>1631E</u>	<u>Mercury Bottles</u>	<u>Low Mercury, Cool to 4°C (unpreserved - must send to lab within 48 hours)</u>	<u>28 days</u>

**AZPDES Quarterly Sampling  
MG2-8b and MPO-1b**

ANALYTE GROUP	LAB	COC Quote ID	EPA METHOD NUMBER	SAMPLE CONTAINER	PRESERVATION METHOD	HOLDING TIME
---------------	-----	--------------	-------------------	------------------	---------------------	--------------

**Dissolved Trace Metals**

Arsenic	SVL	AZPDES - Seeps	200.8	500 ml poly	Field Filtered, HNO3; to pH <2 and cool to 4°C	6 months
Beryllium	SVL	AZPDES - Seeps	200.8			
Cadmium	SVL	AZPDES - Seeps	200.8			
Chromium (Total)	SVL	AZPDES - Seeps	200.7			
Copper	SVL	AZPDES - Seeps	200.8			
Iron	SVL	AZPDES - Seeps	200.7			
Lead	SVL	AZPDES - Seeps	200.8			
Manganese	SVL	AZPDES - Seeps	200.7			
Nickel	SVL	AZPDES - Seeps	200.7			
Selenium	SVL	AZPDES - Seeps	200.8			
Zinc	SVL	AZPDES - Seeps	200.7			
Chromium VI	Test America	Chromium VI	SM3500CrD	500 mL Bottle, Field Filtered	Cool to 4°C	24 hrs
Mercury - Low Level	Test America	Low Level Mercury	1631E	Mercury Bottles	Low Mercury, Cool to 4°C (unpreserved - must send to lab within 48 hours)	28 days

**Inorganics**

Cyanide, Total & Dissolved	SVL	AZPDES - Seeps	EPA 335.2	250 ml poly	1-Bottles, 1-Field Filter, NaOH to pH, >12, Cool to 4°C	14 days
----------------------------	-----	----------------	-----------	-------------	---	---------

**Field Parameters**

Dissolved Oxygen (mg/L)	Field
Flow Rate (MGD)	Field
pH (S.U.)	Field
Specific Conductivity	Field
Temperature (°C)	Field

**SVL COC:** AZPDES Seeps

**Test America COC:** AZPDES-Chrom VI Dissolved (Field Filtered); AZPDES-Chrom VI Total (Unfiltered); Low Level Mercury Total; Low Level Mercury Dissolved

Updated 7-29-2019

## **ATTACHMENT E: POST-CLOSURE TAILINGS SEEPAGE MANAGEMENT AND MITIGATION PLAN**





**Pinto Valley Mine**

# **Post-closure Tailings Seepage Management and Mitigation Plan**

**July 10, 2020**



# Table of Contents

- 1 Introduction ..... 1**
  - 1.1 Purpose and Objectives ..... 1
  - 1.2 Background Information ..... 2
    - 1.2.1 Site Information ..... 2
    - 1.2.2 Regulatory Context..... 2
    - 1.2.3 Tailings Seepage Rates ..... 3
    - 1.2.4 Tailings Reclaim Water (Porewater) Quality ..... 3
    - 1.2.5 Current Groundwater Quality Downgradient of the TSFs ..... 3
- 2 Flow and Particle Tracking..... 5**
  - 2.1 Technical Approach for Flow and Particle Tracking for Predictive Model ..... 5
    - 2.1.1 Lithologic Domains ..... 6
    - 2.1.2 Hydraulic Conductivity, Effective Porosity, and Specific Yield ..... 6
  - 2.2 Particle Track Results ..... 6
    - 2.2.1 TSF3..... 7
    - 2.2.2 TSF4..... 7
- 3 Geochemical Modeling ..... 8**
  - 3.1 Technical Approach and Methods ..... 8
    - 3.1.1 Data Sources and Assumptions ..... 8
    - 3.1.2 Geochemical Modeling Software ..... 9
  - 3.2 Geochemical Model Construction ..... 9
    - 3.2.1 Flow Paths..... 10
    - 3.2.2 Facility Source Term Solution Chemistry ..... 10
    - 3.2.3 Initial Cell Solution Chemistry..... 11
    - 3.2.4 Geological Composition of the Model Cells ..... 11
    - 3.2.5 Physical Cells ..... 12
    - 3.2.6 Atmospheric Gases ..... 12
    - 3.2.7 Surface Reactions and Ion Exchange..... 12
    - 3.2.8 Advective Transport ..... 13
    - 3.2.9 Calibration ..... 13
    - 3.2.10 Model Flow Paths ..... 13

**4 Mitigation Thresholds..... 17**

**5 Documentation and Reporting..... 19**

**6 Adaptive Management..... 20**

**7 References..... 21**

**List of Tables**

Table 1 Reference regulatory standards for groundwater, seeps/springs, and outfalls at PVM and for Pinto Creek surface water.....24

Table 2 Aquifer properties used in particle tracking simulations – Base and sensitivity cases .....25

Table 3 Summary statistics for particle tracking results for TSF3 – Base Case.....25

Table 4 Summary statistics for particle tracking results for TSF3 – Sensitivity run with low effective porosity.....26

Table 5 Summary statistics for particle tracking results for TSF4 – Base case.....26

Table 6 Summary statistics for particle tracking results for TSF4 –Sensitivity run with low effective porosity.....26

**List of Figures**

Figure 1 Site location map.....28

Figure 2 Particle track results from the end of mining – Base case.....29

Figure 3 Particle track results from end of mining – Sensitivity run (Low effective porosity).....30

Figure 4 TSF3 particle track profile – Base (top) and sensitivity (lower).....31

Figure 5 TSF4 particle track profile – Base (top) and sensitivity (lower).....32

Figure 6 Wells downgradient of TSF3.....33

Figure 7 Wells downgradient of TSF4.....34

**Appendices**

Appendix A: Background Information and Mitigation Plan

## List of Abbreviations and Acronyms

ACC	Arizona Administrative Code
ADEQ	<a href="#">Arizona Department of Environmental Quality</a>
AL	Alert Level
APP	Aquifer Protection Permit
AQL	Aquifer Quality Limit
AWQS	Aquifer Water Quality Standard
AZPDES	Arizona Pollutant Discharge Elimination System
BADCT	Best Available Demonstrated Control Technology
CFR	Code of Federal Regulations
EIS	Environmental Impact Statement
LoM	life of mine
MPO	Mine Plan of Operations
n/a or na	Not applicable
POC	Point of Compliance
PVM	Pinto Valley Mine
PVMC	Pinto Valley Mining Corp.
SRK	<a href="#">SRK Consulting (U.S.), Inc.</a>
SWQS	Arizona Surface Water Quality Standards
TDS	Total Dissolved Solids
TNF	Tonto National Forest
TSF	tailings storage facility
USFS	U.S. Department of Agriculture, Forest Service
USGS	U.S. Geological Survey



# 1 Introduction

To extend the life of the Pinto Valley Mine (PVM) (Figure 1), Pinto Valley Mining Corp. (PVMC) intends to continue development of two existing tailings storage facilities as documented in the Mine Plan of Operations (MPO) (WestLand Resources, 2016). Per the MPO, Tailings Storage Facility (TSF) No. 3 (TSF3) and No. 4 (TSF4) have been constructed, operated and monitored since 1973 and 1977, respectively, and will gradually extend onto National Forest System lands administered by U.S. Department of Agriculture, Forest Service (USFS), Tonto National Forest (TNF). TNF issued the *Pinto Valley Mine Draft Environmental Impact Statement (EIS)*, on December 13, 2019 (USFS, 2019). One of the mitigation measures of the Draft EIS requested PVMC develop this *Post-closure Tailings Seepage Management and Mitigation Plan (Plan)*.

## 1.1 Purpose and Objectives

The Plan summarizes the hydrogeological and geochemical modeling that has been and will be performed in advance of closure to predict the impact of tailings seepage on groundwater downgradient of the TSF3 and TSF4. Groundwater, seeps, and springs downgradient of the TSFs will be monitored during the remaining life of mine (LOM) and through the post-closure period as part of PVMC's compliance monitoring programs under Aquifer Protection Permit (APP) No. P-100329 and Arizona Pollutant Discharge Elimination System (AZPDES) Individual Permit No. AZ0020401, and supplemental monitoring programs. The Plan summarizes these monitoring activities and the mitigation measures that will be implemented in the event tailings seepage entering Pinto Creek exceeds relevant regulatory surface water and groundwater water quality standards.

This Plan includes:

- Background information on the current and expected conditions for the TSFs;
- Modeling work that has been and will be performed prior to closure to predict the post-closure flow routes and water quality of groundwater flowing beneath the TSFs towards Pinto Creek and ultimately to downstream aquifers;
- A summary of the planned post-closure tailings seepage monitoring including:
  - the existing APP and Arizona Pollutant Discharge Elimination System (AZPDES) compliance monitoring requirements,
  - supplemental groundwater and surface water monitoring requirements; and
  - supplemental monitoring inspections of seepage collections systems;
- Contingency plan for exceedances of water quality and site condition requirements implemented in the APP and AZPDES programs;
- Documentation and Reporting – Post-closure annual reports provided to TNF;
- Mitigation trigger thresholds for constituents in post-closure tailings seepage that may potentially exceed relevant regulatory thresholds. Mitigation trigger thresholds would be modified to address the most recent regulatory threshold in the event that regulatory thresholds evolve in the future; and

- Discussion of post-closure groundwater extraction and conveyance systems to pump and/or pump and treat tailings impacted water downgradient from the closed and ultimately reclaimed TSFs.

## 1.2 Background Information

### 1.2.1 Site Information

PVM operates facilities and infrastructure to provide water for milling, copper processing, and tailings disposal operations. Pumping from PVM's water production wells captures tailings seepage with the result that groundwater north of TSF4 dominantly reports to four or five of the Peak wells rather than reporting to downgradient aquifers near Pinto Creek. Tailings seepage to groundwater from TSF3 is largely captured by Peak Well No. 26.

During the latter few years of the mine life, pumping from the wells will decrease as the mine production ramps down and the mine transitions to closure. When all pumping ceases, the tailings seepage will then flow naturally downgradient towards Pinto Creek. The phreatic surface within the TSFs and the water level mounding underneath them will subside during the post-closure draindown period. The tailings draindown will be diluted by regional groundwater and flow downgradient of the facility, eventually reaching a steady state condition.

On-going post-closure pumping at the rate of pumping during mine operation would propagate the cone of depression in the aquifer and stream systems and delay the resumption of steady-state post-closure conditions. Targeted operation of select wells at the immediate toe of the tailings facilities, however, would provide for a gradual transition from full-scale production-related drawdown to steady-state post-closure water level conditions.

The subsections below provide additional information on the regulatory context, tailings seepage. Appendix A provides additional information on the:

- Estimated tailings seepage rates during the remaining operations and post-closure periods;
- Water quality of the tailings porewater (also called "reclaim water" or "supernatant");
- Water quality of groundwater downgradient of the TSFs; and
- Wellfield extraction rates downgradient of the TSFs.

### 1.2.2 Regulatory Context

The APP sets forth the requirements for the protection of groundwater quality related to discharges from the TSFs in conjunction with the operation and closure of the tailings facilities. APP conditions govern in accordance with 36 Code of Federal Regulation (CFR) 228.8 (b) and (h). The point-of-compliance (POC) wells downgradient of the TSFs have demonstrated compliance with required Arizona Aquifer Water Quality Standards (AWQSS) (Table 1) since well installation and are expected to continue to comply with standards based on no substantive change in ore type, processing methods, or waste disposal methods in future operations. Groundwater distal from TSF4 is not expected to exceed these relevant water quality standards such that sustained pumping, water treatment, and sludge disposal would be required.

The AZPDES Permit sets forth the requirements for compliance monitoring of seeps, springs, and outfalls at PVM. The water quality results submitted to ADEQ are compared to daily maximum and monthly average Alert Levels (ALs), as well as to discharge limitations referencing Arizona Surface Water Quality Standards (SWQSS).

Arizona Administrative Code (AAC) R18-11 promulgates SWQs for designated uses in specific reaches of various Arizona streams and rivers. The designated uses for the reach of Pinto Creek downstream from an unnamed tributary at 33°19'27"/110°54'56", which includes the reach of Pinto Creek that flows past the Carlota and PVM mine sites, are:

- Aquatic and Wildlife (warm water),
- Full-Body Contact, Fish Consumption,
- Agricultural Irrigation, and
- Agricultural Livestock Watering.

The aquatic and wildlife (warm water) site-specific copper standard for Pinto Creek is 0.034 mg/L for hardness values below 268 mg/L (see Appendix C of AAC R18-11). The reference SWQs are listed in Table 1.

### 1.2.3 Tailings Seepage Rates

Seepage that occurs at the toe of the TSF embankments is captured by collection ponds, caisson pumping systems, and/or groundwater supply wells. Tailings reclaim water ponds are managed at the upstream portion of the TSFs to recover as much water as possible for re-use in the mill. Draindown of porewater within the TSFs seeps directly to groundwater under the expanding footprint and is dominantly captured by the nearby water production wells. During the post-closure period as the phreatic surface within the TSFs and the mounding below the TSFs subsides, the seepage entering groundwater will follow the natural flow gradient towards Pinto Creek area as discussed in detail in Section 2. The seepage rate is modeled to linearly increase during TSF construction and then exponentially decrease during post closure until the seepage rate is consistent with natural recharge from precipitation through the covered facilities (SRK, 2019). Additional discussion on the seepage rates is presented in Appendix A.

### 1.2.4 Tailings Reclaim Water (Porewater) Quality

Tailings reclaim water (also called porewater if collected subsurface from boreholes in the TSFs) is typically a calcium-magnesium-sulfate type water that is near neutral to alkaline with trace metals/metalloids that can reflect the gangue or other minerals associated with the ore deposit (SRK, 2016a).

Samples of reclaim water from TSF3, TSF4, and the blended water from both TSFs taken from 1993 to 2020 are elevated in sulfate, total dissolved solids (TDS), and fluoride. There are no numeric water quality standards for process solution such as reclaim water. With respect to reference AWQs, at least one of the reclaim water samples taken since 1993 has exceeded reference AWQs for nickel, selenium, thallium, and/or fluoride. Two historical samples from the 1990s exceeded the reference manganese SWQS for agricultural irrigation use for this reach of Pinto Creek but these are outliers based on more recent analyses. Additional discussion on the tailings reclaim water quality is provided in Appendix A.

### 1.2.5 Current Groundwater Quality Downgradient of the TSFs

Typically, groundwater affected by infiltration of sulfide tailings porewater into an alluvial or bedrock aquifer generally has near neutral pH values and elevated sulfate and TDS concentrations relative to baseline conditions distant from a tailings facility. Tailings indicator parameters such as pH, sulfate, TDS, as well as other trace metals, metalloids, and major cations and anions are monitored at PVM at the Point-of-Compliance (POC) and Alert Level (AL) wells and monitoring points, and the results

are reported to ADEQ; additional sampling points are monitored on a supplemental basis. Aquifer Quality Limits (AQLs) and ALs are established for AWQS constituents. Sulfate, TDS, gross alpha, and the major cations and anions are required monitoring constituents but do not have numeric AQLs or ALs at PVM.

Nineteen constituents and field parameters are analyzed quarterly (pH, temperature, conductivity, TDS, sulfate, and selected metals) and 40 constituents are analyzed on a biennial basis. Fourteen groundwater quality sampling points are in the compliance monitoring program with additional alluvial and bedrock aquifer wells included in the supplemental monitoring program. The POC monitoring points include nine groundwater wells and two springs; there are paired deep and shallow monitoring wells at three locations downgradient of the TSFs. The AL monitoring points consist of one groundwater well, one spring, and one seep (MG1-12b).

The groundwater downgradient of the TSFs is generally near-neutral with selected locations showing elevated TDS and sulfate concentrations indicative of tailings porewater. There were isolated historical exceedances of one or more constituents against the AQLs. There have been no AQL exceedances in the groundwater POC monitoring wells, spring groundwater POC monitoring point, or alert level monitoring locations in recent years. Fluoride is consistently present in concentrations below the site AQL of 4 mg/L. APP-1A (Gila-shallow) and APP-1Br (Dripping Springs-deep) immediately north of TSF4 measure no exceedances of site AQLs or ALs and have elevated sulfate concentrations. APP-2 (dacite) northwest of TSF4 has sulfate concentrations ranging from 496 to 576 mg/L, and no exceedances of site AQLs or ALs (PVMC, 2017). Well pair APP-3A (dacite-deep) downgradient of TSF3 in Gold Gulch measures sulfate concentrations from 1,220 to 1,330 mg/L. Nearby APP-3B (alluvium/dacite-shallow) measures low sulfate concentrations (45.1 to 48.7 mg/L).

## 2 Flow and Particle Tracking

The sections below summarize PVMC's work related to the existing PVM groundwater and particle flow tracking models as a tool to evaluate and predict the effects of tailings seepage to groundwater and surface water downgradient of PVM's TSFs and to support post-closure predictions and planning. The output from this particle track modeling is used to inform the updated geochemical modeling completed prior to closure.

### 2.1 Technical Approach for Flow and Particle Tracking for Predictive Model

The basis and results of a numerical groundwater flow model completed for the Pinto Creek Watershed was provided to TNF in the report *Pinto Valley Mine – Groundwater Modeling for Mine Extension (Revised)* (SRK, 2019b). The PVM numerical groundwater flow model was created in MODFLOW-SURFACT (version 4) incorporating various inputs and site conditions through MODFLOW-SURFACT packages including:

- ET – Evapotranspiration,
- FWL4 for groundwater extraction pumping,
- LAK2 for pit lake infilling, and
- SFR – Stream Routing to simulate surface water drainages and the stream-aquifer interaction.

The groundwater flow model incorporated water level and aquifer testing data available through December 2018. The groundwater model will be maintained and periodically validated during operations and the post-closure periods to support the on-going assessment of water level trends, the response by the alluvial and bedrock aquifers to water production pumping, changes in tailings water fluxes, and the potential post-closure impacts from tailings seepage. This groundwater model will provide the output necessary for predictive flow and particle tracking as described below.

The groundwater flow model represents many flow paths by grouping the flow fields together into model elements that allow numerical computations within reasonable time frames. It also allows visualization of the flow vectors in a particle tracking routine. The particle tracks from flow moving from the base of TSF3 and TSF4 through the geological formations and aquifers downgradient of the TSFs were output from the groundwater flow model using the MODPATH (version 7) package. MODPATH is a post-processing model that computes three-dimensional (3D) flow paths based on the MODFLOW model. As described in a [user guide](#) by the U.S. Geological Survey for a prior version, the program uses a semi-analytical particle-tracking scheme that allows an analytical expression of a particle flow path to be obtained within each finite-difference grid cell. A particle path is computed by tracking a particle from one cell to the next until it reaches a boundary, an internal sink/source, or satisfies another termination criterion. During the particle movement, hydraulic gradient is dynamically obtained from numerical model for each time step of the simulation.

Particle seeds (i.e., starting points) originating from beneath LOM footprints for TSF3 and TSF4 (Figure 2) were selected to represent the TSFs for predictive modeling of post-closure flow routes, travel velocities, travel distances, and future water chemistry. Shallow seepage or stormwater that flows from the embankment face or in the vadose zone will be captured by the stormwater/seepage ponds at the toes of the TSFs. For the work presented in this Plan, the particle track modeling

assumed a conservative post-closure condition in which no hydraulic controls (such as a pumpback groundwater well network) are in place to capture tailings seepage that enters the groundwater aquifers directly under the footprint of the TSFs.

### 2.1.1 Lithologic Domains

Lithologic domains were established based on surface and subsurface geology established by PVMC through surface mapping and drilling. Particles traveling in groundwater underneath and downgradient of TSF4 will flow nearly equally through Apache Leap Tuff (locally called dacite) on the northwestern and southwestern side of the TSF and Gila Group (locally called Gila conglomerate) on the northeastern and southeastern sides of the TSF. Particles traveling from TSF3 will flow through nearly equal proportions of dacite, Gila conglomerate, and Paleozoic limestone. Thin lenses of alluvial sediments are present in the tributaries downstream of the TSFs and upstream of Pinto Creek.

### 2.1.2 Hydraulic Conductivity, Effective Porosity, and Specific Yield

In advective transport modeling, velocity of a particle is governed by hydraulic conductivity, effective porosity, and hydraulic gradient. For this analysis, hydraulic conductivity values were directly transferred from the calibrated numerical model (SRK, 2019).

Effective porosity or “connected porosity” values are currently unknown. In the absence of direct measurements for effective porosity, SRK assumed that the values are nearly equivalent to specific yield values, which is a common modeling approach. The base case simulation was run with effective porosity set equal to specific yield.

To address the uncertainty regarding effective porosity, a second, conservative sensitivity simulation was run with effective porosity set to 50 percent lower than the calibrated specific yield, which would result in faster travel times. The hydraulic conductivities and effective porosities used in the particle tracking simulation are presented in Table 2.

## 2.2 Particle Track Results

Particle track modeling was completed to estimate the post-closure flow directions and travel rates of seepage that enters groundwater beneath the footprint of the TSFs that will not be captured by the seepage collection ponds located at the toes of the TSFs and will eventually move downgradient from the TSFs towards Pinto Creek. Figure 2 provides a plan view of the flow directions and distances traveled for particles seeded within TSF3 and TSF4 under the base case. Figure 3 presents the flow directions and distances traveled within these TSFs under the sensitivity case (reduced effective porosity). For both cases, the tracking starts at the end of mining and continues for 100 years. Color coding is used to show the trajectories and distances traveled at 25, 50, and 100 years post closure. The figures illustrate that under both cases the seepage will dominantly flow in a northwestward (approximately N20W) path downgradient from TSF4 and in a similar northwestward path downgradient of TSF3.

Table 3 lists the travel velocity in ft per day from the toe of the TSF3 to Pinto Creek under the base case. Travel distances are listed on a daily, monthly, and yearly basis for particles traveling from TSF3 through the alluvium, Gila conglomerate, dacite, and limestone formations. Table 4 lists the travel velocities for TSF3 under the sensitivity case with the reduced effective porosity.

Table 5 and Table 6 present the particle tracking statistics and travel velocities for TSF4 for the base case and sensitivity case, respectively. Observations specific to TSF3 and TSF4 are provided in Sections 2.2.1 and 2.2.2, respectively.

### 2.2.1 TSF3

The horizontal distance from the toe of the northwest embankment of TSF3 to Pinto Creek ranges from approximately 731 m (2,400 ft) to 1,289 m (4,200 ft). From the southeast portion of TSF3, the distance to Pinto Creek is approximately 2,438 m (8,000 ft).

The 3D flow path particle seeds were established at equidistant locations at the contact of TSF3 with the underlying formations (Figure 3). During the post-closure period (assuming no pumping occurs), the 3D particle tracking indicates that TSF3 seepage to groundwater is expected to pass through the limestone and dacite formations eventually moving through the alluvium to discharge to Pinto Creek.

The modeling results show that TSF3 seepage to groundwater following operations is estimated to travel between approximately 2,534 m (8,313 ft) in 65.3 years in the base case simulation (Table 3) to 2,405 m (7,889 ft) in 26.7 years in the low porosity sensitivity simulation (Table 4).

Reducing the effective porosity in the sensitivity case substantially reduces the travel time of the selected representative seed (Particle #10) to arrive at Pinto Creek. The Particle #10 track is shown as a heavy red line on the plan view insets on Figure 4. Figure 4 presents a profile view of the 3D modeled path Particle #10 is predicted to take through the formations for the base and sensitivity cases.

### 2.2.2 TSF4

The horizontal distance from the toe of the northwest embankment of TSF4 to Pinto Creek ranges from approximately 1,219 m (4,000 ft) to 3,048 m (10,000 ft). From the southeast portion of TSF4, the distance to Pinto Creek is more than 4,572 m (15,000 ft).

The 3D flow path particle seeds were established at equidistant locations at the contact of TSF4 with the underlying formations (Figure 2). During the post-closure period (assuming no pumping), the 3D particle tracking indicates that TSF4 porewater passes through dacite and Gila conglomerate before moving through the alluvium to Pinto Creek.

The modeling results show that discharge of TSF4 porewater to groundwater following operations is estimated to travel between approximately 3,738 m (12,263 ft) in 42.7 years in the base case simulation to 3,654 m (11,990 ft) in 23.4 years in the sensitivity simulation (Figure 4). Reducing the effective porosity nearly halves the arrival time of a selected representative seed (Particle #15) flowing from the center of TSF4 towards Pinto Creek. The Particle #15 track is shown as a heavy red line on the flow path insets on Figure 5. This figure presents a profile view of the 3D modeled path Particle #15 is predicted to take for base and sensitivity cases.

# 3 Geochemical Modeling

Geochemical static and kinetic test work of tailings solids has been completed at PVM. This section presents PVMC's work related to geochemical predictions (also called transport modeling) of post-closure groundwater quality downgradient of TSF3 and TSF4. These predictions can be performed as conservative mixing models (i.e., non-reactive fate transport) or as reactive fate transport models that account for geochemical reactions occurring between the different flow components and the aquifer solids such as precipitation of secondary minerals and/or attenuation. The discussion below assumes reactive transport modeling is performed.

## 3.1 Technical Approach and Methods

The geochemical predictive modeling effort relies on existing geochemical data that are available. As mentioned in Section 2.1, the groundwater flow model provides the hydraulic flow parameters and particle travel trajectories and travel times needed for the reaction transport model. The reaction transport simulations will be performed using the geochemical modeling code PHREEQ.

### 3.1.1 Data Sources and Assumptions

PVMC and their technical consultants compiled geochemical modeling data from the previously prepared numerical models, published literature, site water quality analyses, and a site-wide geological model. SRK (2018b; 2019b) prepared a hydrogeology model that provided the framework for the numerical flow model based on surface maps published by U.S. Geological Survey (USGS) (Peterson et al., 1951; Peterson, 1962), PVM's mine development block model, and contacts, rock types, and other data extracted from PVM's files. This hydrogeological model will be updated through time, as needed.

Site groundwater quality data will be compiled from historic and recent sampling results through a relevant period prior to closure. The water quality analyses will include selected wells representing background conditions upgradient of the TSF3 and TSF4 and current conditions downgradient of the TSFs. The pumping and monitoring wells with flow, pore pressure, water level, and/or water chemistry data near TSF3 are shown on Figure 6. These water level and water chemistry data will be updated, as needed, for the on-going operations and post-closure modeling. The current pumping and monitoring wells near TSF4 are shown on Figure 7.

Water quality samples representing tailings porewater are currently available from 1993 through 2020. Updated water quality samples will be taken prior to closure, as needed, from the reclaim water (also called supernatant) ponds at the upstream portion of each TSF and/or from a blended water stream pumped to the mill representing average conditions for the TSF reclaim water.

Geochemical characterization of the bedrock and basin-fill formations and the mining related facilities was initially performed in 1995 as part of site characterization studies required under the APP program (Schafer and Associates, 1995). Additional geochemical characterization for the tailings was performed by others from 2004 through 2016 as documented in a technical memorandum submitted to TNF (SRK, 2016). Analyses of representative samples collected by SRK and analyzed for mineralogy of the Gila conglomerate and Pinto Creek alluvium are also available to support a site-wide reaction transport model.



### 3.1.2 Geochemical Modeling Software

U.S. Geological Survey (USGS) software package PHREEQC (Parkhurst and Appelo, 2013), or other industry-accepted, best practice geochemical modeling software package available before closure, will be used for the geochemical modeling simulations. PHREEQC is an established program accepted by regulatory agencies. Any deviation from use of PHREEQC toward another industry-accepted modeling software package will be reviewed and approved by the Forest Service prior to its implementation. The code is written in C language and has the capability to perform a wide variety of low-temperature aqueous calculations and simulations. The code possesses capabilities for 1) speciation and saturation-index calculations, 2) batch-reaction and one-dimensional transport calculations involving reversible reactions, which include aqueous, mineral, gas, solid-solution, surface-complexation, and ion-exchange equilibria, and irreversible reactions, which include specified mole transfers of reactants, kinetically controlled reactions, mixing of solutions, and temperature changes; and 3) inverse modeling, which finds sets of mineral and gas mole transfers that account for differences in compositions between waters, within specified compositional uncertainty limits.

PHREEQC is based on equilibrium chemistry of aqueous solutions interacting with minerals, gases, solid solutions, exchangers, and sorption surfaces, but also includes the capability to model kinetic reactions with rate equations. The software package also includes several thermodynamic databases that allow user manipulation and expansion. The database used for this model is a version of the original phreeqc.dat database, but with substantial additions to include aqueous species, phases, and reactions taken from peer reviewed scientific literature.

### 3.2 Geochemical Model Construction

The discussion below references PHREEQC but will likely be relevant to other future modeling programs available at the time of closure. PHREEQC simulates one-dimensional transport analogous to water moving through a laboratory column, and in the case of groundwater flow the columns are oriented semi-horizontally along the flow paths generated by the groundwater flow model. Thus, simulation of multiple flow paths requires the definition of separate “columns” for each flow path that will be simulated. On the molecular scale of a groundwater flow system, there is an infinite number of flow paths. As mentioned in Section 2.1, the flow model can group the flow fields together into model elements that allow numerical computations within reasonable time frames. It also allows visualization of the flow vectors in a particle tracking routine. Even on the scale of model elements, however, there are too many flow vectors from each source area to simulate as individual flow paths in the reaction transport model.

As a simplification, each geochemical source area is represented in PHREEQC by one flow path. This is considered a valid approach primarily because there are no documented spatial variations of source term chemistry within the facilities. Furthermore, within the time frames of the predictive simulations, the differences in travel times from different locations in each facility to their respective discharge points is a few years at most, which is not enough to make a significant difference in the chemical evolution at the destination. Incorporation into the geochemical model of incremental changes within each facility is not practical within the constraints of the model time steps, which in cases are longer than 12 years.

Geochemical reactions between the source waters and the minerals in the bedrock aquifer are simulated by incorporating available knowledge regarding mineralogy of the bedrock materials. It is

not possible to incorporate into the model every element and mineral present in the bedrock, and TSFs for two reasons. First, identifying every mineral present would be prohibitive given the range of minerals present and the limitations of analytical methods, particularly for trace levels of minerals. Second, thermodynamic data do not exist for every mineral that might be present, so there would be no benefit in including them in the model. Assumptions are necessary to allow constraining the model to known parameters while incorporating those mineral phases that influence and control the evolution of groundwater chemistry.

Simulating movement and reaction of water through a geologic media in PHREEQC requires the definition of cells through which the solution is transported or shifted. The media in this case are the geologic formations that make up the bedrock and alluvial aquifers hydrologically downgradient from the source facilities. The model requires the chemical composition of solutions that occupy the rock pore spaces to be defined initially, before transport starts. The model also requires that the infiltrating water be defined initially by assignment of a chemical composition, which in this case is the source term chemistry of each facility. Hydrologic flow within each flow path will be assumed to be non-diffusive advection with one-dimensional longitudinal dispersion. The rate of flow along each flow path will be provided by the most recent groundwater flow model and is a necessary input to the geochemical model for the purposes of calculating mineral reaction rates.

Meteoric precipitation is not incorporated directly, rather it is assumed that the source terms are a result of prior rock-water interaction between infiltrating meteoric precipitation and the geologic materials in the facility. Likewise, non-contact groundwater is assumed to be a result of rock-water interaction between infiltrating precipitation and the geologic materials into which the infiltration occurs.

### 3.2.1 Flow Paths

As described in Section 2.1, flow paths will be defined to simulate reactive transport of tailings seepage that is discharged from TSF3 and TSF4 to groundwater. The travel time of particles along their respective flow paths will be calculated based on the elapsed time from first discharge to groundwater to the time that the particle reports to its termination point, which is Pinto Creek. Simulations will be completed for different post-closure time frames at approximately 10, 25, and 100 years following the cessation of pumping.

The remaining primary source area that controls the quality of groundwater is natural background groundwater, defined as groundwater that has experienced negligible impact from mining. This source will not be assigned a flow path and will be included in the model at the final stage of modeling, mixed with the flow path sources in proportion to its fraction of contribution as calculated by the groundwater flow model. Meteoric precipitation that infiltrates to groundwater and mixes with the solution traveling along the flow tube will not be included as a separate solution, rather will be assumed to be incorporated into the chemical composition of the background groundwater solution that is mixed with the flow path solution at the final model stage.

### 3.2.2 Facility Source Term Solution Chemistry

Source terms for TSF3 and TSF4 will be defined based on existing data including prior geochemical characterization of the tailings solids from static and kinetic test work and from the reclaim water samples taken from 1993 to through to data available near the time of modeling.

All source term solutions will be assumed to be in a condition of equilibrium with atmospheric carbon dioxide ( $p\text{CO}_2 = -3.4$ ) and oxygen ( $p\text{O}_2 = -0.67$ ), and the solutions are maintained in that state until they are shifted into the groundwater domain. Once the model transports the source solutions to groundwater and into Cell 1 of each reaction flow path, that constraint is removed, and gas phase equilibria is controlled by the geochemical reactions in the aquifer.

Redox speciation in the source terms will be calculated by PHREEQC based on the distribution of redox couples (e.g., nitrate-nitrite or ferrous-ferric iron) where analytical data for redox couples are available.

### 3.2.3 Initial Cell Solution Chemistry

Geochemical transport through groundwater will be modeled by dividing each flow path into cells, the number of which is equal to the number of groundwater flow model elements along the particle track for each facility. The pore solution occupying each cell in each flow path will be specified initially then allowed to evolve as the model progresses through time and pore solutions are transported down the flow path. Concentrations reported below detection limits will be entered at one-half the detection limit. All solutions will be charge balanced on conservative ions such as chloride or magnesium in the simulations.

### 3.2.4 Geological Composition of the Model Cells

The geologic composition of each flow path cell will be defined initially and will be based on the groundwater flow model elements through which each particle track vector traverses. For example, the particle track flow paths from TSF4 are expected to travel through model elements containing both dacite and Gila conglomerate.

Each model cell would be specified to contain finite concentrations of mineral phases that have been documented in the specific geologic units defined in the model and that are important in the control of major and trace elements. The initially defined mineral concentrations will be based primarily on existing data that consist of a combination of multi-element analyses, petrographic evaluations, X-ray diffraction mineralogy, and scanning electron microscopy. Additional assumptions will be incorporated regarding plausible mineral phases that are likely to be present in the bedrock aquifers but are not definitively identified in the analyses. Initially specified mineral concentrations are supported by laboratory analytical data.

PHREEQC allows differentiation between mineral phases assumed to participate in equilibrium reactions versus minerals assumed to weather kinetically (i.e., variable through time). A small suite of minerals will be defined in the model based on published kinetic rate laws. The rate laws define parameters for mineral dissolution only, thus no provision is made in the model for kinetically controlled minerals to precipitate. The pyrite dissolution rate is from Williamson and Rimstidt (1994), the chalcopyrite dissolution rate is from Kimball et al (2010), and the remainder (albite, andesine, anorthite, augite, biotite, hornblende, potassium feldspar, labradorite, muscovite/sericite) are from Palandri and Kharaka (2004).

Minerals that are allowed to participate in equilibrium reactions, and the constituent elements of these phases are allowed to shift between the aqueous and solid phase as thermodynamic conditions along the reaction path dictate. The saturation state is calibrated based on the concentrations in the existing groundwater pore solutions, so that the model output is constrained, and concentrations do not exceed plausible limits. Minerals that dissolved kinetically are not allowed

to re-precipitate, a condition that is not generally possible anyway since the dissolution reactions are irreversible.

Initial concentrations of mineral phases in the model cells will be defined based on laboratory analyses and visual observations. Due to the difficulty of characterizing the entire 3-dimensional mineralogical composition of all geologic units, reasonable assumptions are made to provide conservation of mass in the simulations and to ensure that elements that are expected to exert control on solution chemistry are specified in at least one phase. For example, all barium is assumed to exist in the mineral barite, and all fluorine is assumed to exist in the mineral fluorite even though those mineral phases may not be the only sources of those elements. Dawsonite ( $\text{NaAlCO}_3$ ), epsomite ( $\text{MgSO}_4 \cdot 7\text{H}_2\text{O}$ ), and sepiolite ( $\text{Mg}_4\text{Si}_6\text{O}_{15}(\text{OH})_2 \cdot 6\text{H}_2\text{O}$ ) are not present in any cells initially but are defined as controlling precipitate phases for magnesium. Although the mineral equilibrium phases are defined with initial concentrations of 0 moles, the mineral phases are allowed to precipitate and re-dissolve with model progression as conditions dictate.

Although it has not been identified in significant concentrations in the host rocks, gypsum ( $\text{CaSO}_4 \cdot 2\text{H}_2\text{O}$ ) is expected to exert equilibrium solubility control of sulfate in the TSF porewaters, and that equilibrium control would be translated to the groundwater where sulfate concentrations are maintained in the range of 1200 to 1700 mg/L.

### 3.2.5 Physical Cells

Construction of a reaction transport model in PHREEQC (or equivalent geochemical model) requires input data on density, porosity, and particle size of the geologic media with which to calculate molar concentrations of elements and minerals available for chemical reactions. The density of each geologic unit will be taken from published information. The porosity of each geologic cell will be based on published values for fracture porosity (Freeze and Cherry, 1979). Particle size will be estimated based on site knowledge or estimated and ranged from 0.0 to 5 mm depending on the specific mineral. Sulfides would occupy the low end of the range while the silicates the high end.

Hydrodynamic dispersivity of each model cell will be set uniformly at 15 percent of flow cell length in accordance with PHREEQC convention. Dual porosity will not be modeled as there are no data available on which to base the calculations.

### 3.2.6 Atmospheric Gases

The source term solutions will be set at equilibrium with atmospheric pressures of carbon dioxide ( $\text{CO}_2$ ) and oxygen ( $\text{O}_2$ ). In the flow path cells,  $\text{CO}_2$  partial pressure is set based on speciation calculations made by PHREEQC just before reaction simulations are executed for each flow path. In the final downgradient simulation that mixes the various flow paths with background groundwater, the  $\text{CO}_2$  partial pressure of the resultant mix will be fixed at the value calculated by PHREEQC for present day groundwater conditions ( $p\text{CO}_2 = -1.71$ ), which is a partial pressure of  $10^{-1.71}$  atmospheres). Constraints are removed for  $\text{O}_2$  allowing it to freely evolve as dictated by reaction progress.

### 3.2.7 Surface Reactions and Ion Exchange

Adsorption will be included as a geochemical process in cells that are known to contain documented concentrations of iron hydroxides. The concentrations of iron hydroxides are defined in advance for each geologic unit containing documented concentrations of iron. The adsorption medium selected will be hydrous ferric oxide (HFO), and the concentration of HFO available is based on the

mineralogical and elemental analyses of each geologic unit. No credit will be provided for additional HFO precipitated during the reaction path.

Ion exchange is simulated in cells that are known to contain concentrations of a viable ion exchanger, such as illite or montmorillonite clay.

All cells will be initially assumed to be in equilibrium with the surface adsorption substrate and the ion exchanger, and they will be assumed to maintain a condition of equilibrium throughout the simulations. This feature of PHREEQC incorporates a built-in database containing thermodynamic data for numerous ions that can engage in surface adsorption and ion exchange. The species in the PHREEQC surface sorption database that will be included in the model are: antimony, arsenic, barium, beryllium, cadmium, calcium, cobalt, copper, chromium, fluoride, lead, magnesium, manganese, mercury, molybdenum, nickel, phosphorus, selenium, silver, strontium, sulfate, uranium, and zinc.

The species in the PHREEQC ion exchange database that are included in the model are: aluminum,  $\text{AlOH}^{+2}$ , barium, cadmium, calcium, copper, hydrogen ion ( $\text{H}^+$ ), iron, lead, lithium, magnesium, manganese, potassium, sodium, strontium, and zinc.

### 3.2.8 Advective Transport

Average flow velocities calculated by the groundwater flow model will be assumed for geochemical transport. Having pre-defined initial solutions for the infiltrating solution and the model cells, a simulation cycle, referred to as a shift in PHREEQC, consists of performing all reactions defined in each cell (e.g., kinetic dissolution, equilibrium reactions, sorption), then shifting of the pore solution in each cell into the subsequent downgradient cell. For each shift, the contents of the last cell in the simulation are transported out of the model domain as discharge at the flow path terminus and represent the concentration that is reported as output. Simultaneously, infiltrating source term water (Solution 0) is cycled into Cell 1, the previous contents of Cell 1 are cycled to Cell 2, and so on, and the process begins again for the next simulation step.

### 3.2.9 Calibration

After the model is initially constructed, calibration simulations will be performed to compare the model output produced after one or two cell shifts with the actual water chemistry of the final cell. The rationale for this is that the chemical composition of the discharge from the final cell after the first shift should be very similar to the actual water chemistry in that cell. If the two do not match, parameters of the model, such as solubility control minerals or gas concentrations, will be tuned incrementally until a reasonable match was achieved. When that is achieved, the model is considered calibrated and predictive simulations can be executed.

### 3.2.10 Model Flow Paths

Flow path parameters include the following:

- Total number of cells of each flow path, which corresponds to the number of model grid elements along the particle track;
- Cell length (constant for each cell along a particular flow path);
- Travel time along each flow path;
- Length of each flow path;
- Start and end points of the groundwater flow path as indicated by the particle tracking routine;

- Geologic composition of each flow path cell;
- Initial groundwater chemical composition of each flow path cell;
- Sorption reactions and ion exchange reactions defined for each cell;
- Mineral and gas phases specified as equilibrium controls; and
- Minerals specified to dissolve kinetically.

### **TSF3**

Tailings material was first placed in TSF3 in 1973 (Hargis, 1995). The facility will continue to be used for limited time periods when the TSF4 pipeline and pumping systems are being maintained. Stormwater runoff and seepage is collected by a series of pumps, caissons, collection drains, ditches, ponds and tanks. The water quality downgradient of TSF3 is monitored on a quarterly and biennial basis at monitor wells APP-3a, APP-3B, and APP-4 (see locations in Figure 6). Water quality downgradient of TSF3 indicates a near neutral pH, moderate sulfate concentrations and moderate total dissolved solids (TDS).

TSF3 discharge to groundwater during operations dominantly reports to Peak Well 26 as shown by particle track results. While this well is operational, there is expected to be limited excursion of TSF3 seepage to groundwater or surface water. A flow path centrally located in TSF3 will be chosen to represent the entire tailings facility for the reaction transport model during the closure time frame. TSF3 seepage is expected to flow towards Pinto Creek throughout the post-closure time period.

### **TSF4**

Tailings material was first placed in TSF4 in 1977 (Hargis, 1995). TSF4 is the primary active TSF at PVM and will undergo future expansion to support the LOM plan. Although mining and tailings deposition have been interrupted twice since tailings were first deposited, the presence of elevated sulfate measured in groundwater wells north of TSF4 (i.e., APP-1A and APP-1Br and other downgradient wells shown in Figure 7) is assumed to be evidence that seepage from TSF4 has impacted groundwater since first deposition and will continue to do so throughout the post-closure time period.

It is assumed that nearly all TSF4 discharge to groundwater during operations reports to downgradient Peak wells depending on pumping activity. Therefore, while these wells are operational, there is expected to be limited excursion of TSF4 seepage to groundwater or surface water. A flow path centrally located in TSF4 will be chosen to represent the entire tailings facility for the reaction transport model during the closure time frame. TSF4 seepage will flow towards Pinto Creek throughout the post-closure time period.

### **Non-contact Water**

Non-contact groundwater, also referred to as background recharge, will be defined in the model as the chemical composition of upgradient well APP-7. Wells used to establish background concentrations of specific formations will likely include MW-04-03 in Miller Gulch located upgradient of Pinto Creek and MW-04-15 (now abandoned) and MW-16-100 located upgradient of TSF4. MW-04-03 is screened in Gila conglomerate at 40-90 ft, and MW-04-15 and MW-16-100 are screened in Diabase. These waters are assumed to be a product of water-rock interaction between infiltrating meteoric water and the host bedrock.

## Flow Path Mixing

After the individual flow path simulations have been completed, the final step that produces the groundwater and surface water compositions at their respective compliance points will be to mix the flow path chemistries proportional to their relative contributions as calculated in the groundwater flow model.

As stated previously, the water chemistry signatures of both groundwater and Pinto Creek are not predicted to be influenced by additional loadings from any of the facilities during the operational time period as long as the current Peak well pumping program continues without significant deviation. Thus, the water chemistry observed at the Pinto Creek and groundwater compliance points is assumed to remain unchanged from present day until closure, which is currently predicted in 2039. For that reason, the apportionments will include only forecasts for the approximate 10-year, 25-year, and 100-year closure time frames.

Groundwater: The groundwater flow regime pertinent to discharge at compliance monitoring points during the post-closure timeframe is expected to be very similar, so the source apportionment will be similar in the reaction transport simulations.

Surface Water: The prediction of Pinto Creek water chemistry under the post-closure time frames is anticipated to incorporate the following components:

- The water chemistry at flow path endpoints as predicted by the reaction transport model,
- The water chemistry of Pinto Creek as reported by PVMC, Carlota Copper, or from published literature,
- The relative contributions of the reaction transport model flow paths and non-contact groundwater as calculated by the groundwater flow model, and
- The total flow in Pinto Creek at Magma Weir as measured by the USGS (compiled in SRK, 2018c).

The sum of the hydraulic contributions of the various groundwater flow paths that report to Pinto Creek will be subtracted from the Magma Weir flow to obtain an estimate of annual average Pinto Creek base flow, which in the model is assigned a water chemistry signature based on historical data.

The final water chemistry of Pinto Creek at various locations within the model domain will be derived by mixing all groundwater contributions to Pinto Creek with the Pinto Creek base flow water chemistry calculated as described above. The apportionment of groundwater discharge from the various contact water source areas is predicted by the groundwater as water exiting the groundwater flow model domain. The groundwater inputs will be summed with the stream base flow contribution being the balance of total flows reporting to Pinto Creek.

After wellfield pumping ceases and the final placement of tailings occurs, the water table mounding beneath the TSFs will subside and the drawdown in the wellfield will gradually rebound. Initially, the tailings seepage will largely report to fill the depleted storage area within the drawdown cone downgradient of the TSFs where the seepage will commingle with inflowing groundwater. Particle track modeling shows that the dominant flow paths would take approximately 47 years and 65 years for TSF4 and TSF3 seepage, respectively, to reach Pinto Creek, although some flow from TSF4 (i.e., 1 of the 12 representative particle pathways) is estimated to arrive within 25 years. A portion of the co-mingled groundwater and tailings seepage reporting to Pinto Creek after the drawdown cone has rebounded in 25 to 100 years post-closure will be taken up by plants.

Two thirds (65%) of the surface water measured at Magma Weir is estimated to consist of stormwater runoff from precipitation within the upper Pinto Creek watershed; one third is groundwater reporting as baseflow to Pinto Creek. The majority of groundwater reporting to Pinto Creek at the Magma Weir during the post-closure period is expected to be non-contact groundwater from the upper Pinto Creek watershed. The primary control on Pinto Creek water quality at this location is expected to be un-impacted groundwater and surface water from the upper Pinto Creek watershed, with a portion of contact water from tailings seepage downgradient from the TSFs after the first 25 to 65 years post closure.



## 4 Mitigation Thresholds

Tailings geotechnical best management practices include operational measures to minimize tailings seepage reporting to the embankment surface. The design of the TSFs to drive reclaim water or supernatant to the upstream portion water minimizes discharges of tailings porewater to groundwater to the best extent possible and enhances water conservation and reuse of reclaim water or supernatant.

Monitoring for tailings seepage water is performed during operations as part of the APP<sup>1</sup> and AZPDES<sup>2</sup> compliance monitoring programs and will continue during the post-closure period. Inspections and maintenance are performed to ensure the seepage collection ponds downgradient of TSF3 (i.e., Slack/Conklin, West Catchment, Canyon Dam, East Catchment / Caisson) retain the permitted freeboard level, are intact, and that pumping systems are in good working order. Similarly, inspections and maintenance are performed to ensure good operating order for the seepage collection ponds downgradient of TSF4 (i.e. Rosa's Pond, Charlie Pond, Long Pond). Site monitoring of seeps, springs, and storm water outfalls downgradient of TSF3 and TSF4 are performed as part of the quarterly AZPDES compliance monitoring program.

Contingency Plan requirements for action and adaptive management are established in Section 2.6 of PVM's APP. The APP Contingency Plan establishes actions to be taken in the event there is an exceedance of alert and performance levels such as limits set for the TSF freeboard and the phreatic surface allowed in TSF4 to ensure stability. The APP establishes actions to be taken in the event of exceeding an AL or an AWQS measured in groundwater, seeps, and springs downgradient of the TSFs and for overtopping of the TSF and discharge of unauthorized materials to the environment. This Contingency Plan is in effect for operations, temporary care and maintenance, and closure/post-closure periods and is subject to amendment should substantive changes be made in the future to the operation of the TSFs.

Trigger thresholds for managing post-closure tailings seepage water quality in the APP Contingency Plan are based on numeric groundwater standards (i.e., AWQS). As mentioned in Section 1.2.4, tailings reclaim water is near neutral to alkaline with occasionally elevated fluoride. Downgradient groundwater analyses measured at the POC wells and seep/spring monitoring points since the 1990s are in compliance with AWQSs and site AQLs. The future results are expected to be in the maximum and minimum ranges of past results based on the similar ore types and processing methods to be used during the remaining LOM. The APP Contingency Plan would be modified as necessary in the future in accordance with any updated AWQS numeric or narrative standards applicable to the PVM.

Numeric SWQSs for this reach of Pinto Creek as described in Section 1.2.2 are also relevant to be used as trigger thresholds for contingency action. Table 1 presents the relevant numeric standards for the site. Results of recent samples show that undiluted reclaim water (porewater) meets SWQSs

---

<sup>1</sup> See APP Table 4.2-3 Quarterly Groundwater Compliance Monitoring for Spring POC Monitoring Points and Alert Monitoring Locations; and Table 4.2-5 Biennial Groundwater Compliance Monitoring for Spring POC Monitoring Points and Alert Monitoring Locations.

<sup>2</sup> See AZPDES permit Table 1.a – Discharge Limitations and Monitoring Requirements for Outfalls 002, 003, & 004; and Table 1.b – Discharge Limitations and Monitoring Requirements for Outfall 005.

for this reach of Pinto Creek. Seepage diluted by regional groundwater would be expected to meet SWQs for Pinto Creek. Sulfate and TDS are monitored in compliance and supplemental wells. There are no numeric standards in the APP AQLs or in AWQs, or SWQs for these constituents. ADEQ has the ability to address concerns regarding high concentrations in TDS and sulfate in groundwater or surface water in the future through the implementation of narrative standards (Section R18-11-405 of the Arizona Administrative Code). Monitoring results provided to TNF for the remaining LOM and during the post-closure period will focus on interpreting the trends of tailings-indicator parameters to assess potential changes in groundwater and surface water.

# 5 Documentation and Reporting

PVMC plans to update the results in *Pinto Valley Mine – Groundwater Modeling for Mine Extension* (SRK 2019b) several times prior to site-wide closure (currently estimated to be in 2039). The modeling report will include a discussion of the conceptual model, data sources and assumptions, model construction methods, calibration, and model and sensitivity results for the operations and post-closure timeframes. The predicted future results at various timeframes will be compared with current groundwater quality measured at the existing monitoring wells and monitoring seeps/springs against the relevant applicable groundwater quality standards (i.e., Arizona AWQs and relevant applicable surface water quality standards such as the AZPDES program and Arizona SWQs).

Copies of the annual APP compliance monitoring reports and the annual AZPDES compliance monitoring report will be provided to TNF when produced for ADEQ. These annual monitoring interpretative reports are due to ADEQ by April 30<sup>th</sup> of each year for the preceding calendar year.

# 6 Adaptive Management

Tailings seepage monitoring and management is an integral part of current operations and will continue as a key component of site inspections and facility maintenance during the 30-year post-closure period following full reclamation of the TSFs. The Plan may be continued for a period extending beyond 30-years post-mining, if necessary. A Contingency Plan and adaptive management are key elements of the AZPDES and APP permit programs.

Adaptive management includes activities such as:

- Re-sampling and/or confirming the results of water quality samples that exceed relevant numeric standards;
- Performing evaluations to assess cause(s) of trends or water quality exceedances noted in a particular monitoring point;
- Performing evaluations to ensure the efficiency and good performance of water production wells (i.e., well scans for well integrity, brush and bail programs, review well construction records, and repair/replace required well operation components, as needed)
- Upgrading existing best management practices or implementing potential mitigation steps to manage tailings seepage should relevant water quality standards begin to be exceeded on an on-going basis;
- Review action items from the previous inspection or investigation;
- Visit problematic areas reported by the facility manager and any site maintenance personnel;
- Complete inspections of the TSFs and embankment cover systems, seepage collection systems, stormwater channels and perimeter roadway, at least on an annual frequency;

Conditions that have changed from the previous inspection are evaluated and discussed with the facility manager for additional action or increased frequencies of monitoring, as necessary. The APP Contingency Plan specifies reporting actions that are to be taken in the event of a permit exceedance or violation. Should relevant numeric water quality standards be exceeded on a consistent basis during the post-closure period, PVMC will consider other adaptive or mitigation steps such as:

- Retaining select existing pumping wells to capture tailings seepage;
- Installing a series of pumpback wells to capture tailings seepage and:
  - Pump untreated water to the Open Pit for evaporation and/or permanent storage;
  - Treat captured water to meet AWQs with subsequent re-injection to groundwater;
  - Treat to meet SWQs with subsequent release to Pinto Creek;
- Upgrading existing best management practices and seepage collection ponds;
- Review action items from the previous inspection or investigation;
- Visit problematic areas reported by the facility manager and any site maintenance personnel; and
- Complete inspections of the TSFs and embankment cover systems, seepage collection systems, stormwater collection facilities, and diversion channels and ditches.

# 7 References

- Arizona Department of Environmental Quality, 2004, Arizona Mining Guidance Manual BADCT: ADEQ Publication # TB 04-01, 298 p., accessible at [https://legacy.azdeq.gov/function/laws/download/TB\\_04-01\\_Arizona\\_Mining\\_BADCT\\_Guidance\\_Manual.pdf](https://legacy.azdeq.gov/function/laws/download/TB_04-01_Arizona_Mining_BADCT_Guidance_Manual.pdf)
- Freeze, R.A., and Cherry, J.A., 1979, Groundwater: Prentice-Hall, Englewood Cliffs, New Jersey USA, 604 p
- Hargis + Associates (Hargis), 1995, Preliminary hydrogeologic report: unpublished report prepared for Magma Copper Company, Pinto Valley Mining Division, Miami, Arizona, unpublished report for Magma Copper Company, January 13, 1995, 185 p. 6 appendices (copy provided to TNF)
- Palandri, J.L., and Kharaka, Y.K., 2004, A compilation of rate parameters of water-mineral interaction kinetics for application to geochemical modeling: U.S. Geological Survey Open File Report 2004-1068, Prepared in cooperation with the National Energy Technology Laboratory – United States Department of Energy, 70 p.
- Parkhurst, D.L., and Appelo, C.A.J., 2013, Description of input and examples for PHREEQC version 3 - A computer program for speciation, batch-reaction, one-dimensional transport, and inverse geochemical calculations: U.S. Geological Survey Techniques and Methods, Book 6, Chap. A43, 497 p., available only at <http://pubs.usgs.gov/tm/06/a43/>.
- Peterson, N.P., Gilbert, C.M and Quick, G.L, 1951, Geology and ore deposits of the Castle Dome Area, Gila County, Arizona: U.S. Geological Survey Bulletin 971, 134 p.
- Peterson, N.P., 1962, Geology and ore deposits of the Globe-Miami district, Arizona: U.S. Geological Survey Professional Paper 342, 157 p.
- Pinto Valley Mining Corp., 2017, 2016 Aquifer Protection Permit annual report for Pinto Valley Mine – Permit No. P-100329: report submitted to ADEQ, March 30, 2017, 51 p., 5 appendices.
- Schafer and Associates, 1995, Geochemical evaluation, Magma Copper Company Pinto Valley Mine: unpublished report prepared for Magma Copper Company Pinto Valley Mining Division, February 21, 1995, 56 p, 2 appendices.
- SRK Consulting, 2016, TSF3 and TSF4 tailings characterization and reclamation strategies: unpublished memorandum prepared for Pinto Valley Mining Corp., May 4, 2016, 67 p. (submitted to TNF)
- SRK Consulting, 2017, Application for Significant Amendment to APP No. P-100329 – TSF4 extension design: unpublished report prepared for Pinto Valley Mining Corp. and submitted to ADEQ (copy provided to TNF), March 31, 2017, 45 p., 3 support components, 9 appendices.
- SRK Consulting, 2018a, Mixing calculation assessment of proportion of tailings water in wells downgradient of TSF4 – Response to Pinto Valley Mine EIS Request #108, April 11, 2018: unpublished memorandum prepared for Pinto Valley Mining Corp., July 16, 2018, 6 p.
- SRK Consulting, 2018b, Geologic and hydrologic maps for the Pinto Creek watershed and Pinto

- Valley Mine – Response to Pinto Valley Mine EIS Request (#108), April 11, 2018: unpublished technical memorandum prepared for Pinto Valley Mining Corp., August 13, 2018, 32 p.
- SRK Consulting, 2018c, Pinto Creek stream gauge data reduction – Response to Pinto Valley Mine EIS Request (#108), April 11, 2018: unpublished technical memorandum prepared for Pinto Valley Mining Corp., August 26, 2018, 15 p.
- SRK Consulting (SRK), 2019a, Pinto Valley Mine – Revised work plan for groundwater modeling: unpublished report prepared for Pinto Valley Mining Corp. and submitted to TNF, February 21, 2019, 41 p.
- SRK Consulting (SRK), 2019b, Pinto Valley Mine – Groundwater modeling for mine extension (Revised): unpublished report prepared for Pinto Valley Mining Corp. and submitted to TNF, May 3, 2019, 181 p., 2 appendices.
- United States Forest Service, Tonto National Forest, 2019, Pinto Valley Mine Draft Environmental Impact Statement: published document accessible at <http://www.pintovalleymineeis.us/public.html>, December 13, 2019, 6 appendices.
- Williamson, M.A. and Rimstidt, J.D., 1994, The kinetics and electrochemical rate-determining step of aqueous pyrite oxidation: *Geochimica et Cosmochimica Acta*, v. 58, no. 24, p. 5443-5454.
- WestLand Resources, 2016, Plan of Operations – Pinto Valley Mine: plan prepared for PVMC and submitted to Tonto National Forest, May 13, 2016, 78 p., 9 appendices.

## Tables

**Table 1 Reference regulatory standards for groundwater, seeps/springs, and outfalls at PVM and for Pinto Creek surface water**

Parameter (mg/L unless noted)	AWQS	Arizona Administrative Code (AAC) R18-11				
		FC <sup>1</sup>	FBC <sup>2</sup>	A&Wc Acute <sup>3</sup>	AgI <sup>4</sup>	AgL <sup>5</sup>
Antimony, dissolved				0.088		
Antimony, total	0.006	0.64	0.747			
Arsenic, dissolved	0.05			0.34		
Arsenic, total	0.05	0.08	0.03		2	0.2
Barium, total	2		187			
Beryllium, dissolved	0.004			0.065		
Beryllium, total	0.004	0.084	1.87			
Boron, total			187		1	
Cadmium, dissolved	0.005			0.005	0.05	0.05
Cadmium, total	0.005	0.006	0.467		0.05	0.05
Chromium, total	0.1				1	1
Copper, dissolved				0.034		
Copper, total			1.3		5	0.5
Cyanide (as free cyanide), total	0.2	0.504	0.588	0.022		0.2
Lead, dissolved	0.05			0.185		
Lead, total	0.05		0.015		10	0.1
Manganese			131		10	
Mercury, dissolved	0.002			0.002		
Mercury, total	0.002		0.28			0.01
Nickel, dissolved	0.1			0.012		
Nickel, total	0.1	0.511	28			
Selenium, total	0.05	0.667	4.67		0.02	0.05
Silver, dissolved				0.018		
Silver, total		8	4.67			
Thallium, dissolved	0.002			0.7		
Thallium, total	0.002	0.0001	0.009			
Uranium			2.8			
Zinc, dissolved				0.046		
Zinc, total		5.106	280		10	25
Chlorine (total residual)			93	0.019		
Fluoride	4		140			
Nitrate + Nitrite	10					
Nitrate	10		3733			
Nitrite	1		233			
Benzene	0.005	0.114	0.133	2.7		



**Table 1 Reference regulatory standards for groundwater, seeps/springs, and outfalls at PVM and for Pinto Creek surface water**

Parameter (mg/L unless noted)	AWQS	Arizona Administrative Code (AAC) R18-11				
		FC <sup>1</sup>	FBC <sup>2</sup>	A&Wc Acute <sup>3</sup>	Agl <sup>4</sup>	AgL <sup>5</sup>
Toluene	1	11.96	149	8.7		
Gross Alpha, Total (pCi/L)	15					
Radium 226+228, Total (pCi/L)	5					

Notes:

- 1 FC = Fish consumption
- 2 FBC = Full-Body Contact
- 3 A&Wc Acute = Aquatic and Wildlife (warm water) Acute toxicity
- 4 Agl = Agricultural Irrigation
- 5 AgL = Agricultural livestock watering

**Table 2 Aquifer properties used in particle tracking simulations – Base and sensitivity cases**

Unit	Limestone (generic)	Dacite	Dacite (Productive)	Alluvium	Gila	Tailings	Gila (Productive)
<b>Model Zone Number</b>	<b>11</b>	<b>19</b>	<b>40</b>	<b>22</b>	<b>20</b>	<b>25</b>	<b>39</b>
Effective Porosity, Base Case	0.01	0.05	0.05	0.15	0.05	0.05	0.075
Effective Porosity, Sensitivity Case	0.005	0.025	0.025	0.075	0.025	0.025	0.0375
Hydraulic Conductivity Kx (ft/day)	0.12	0.312	3	10	0.8	6	9
Hydraulic Conductivity Kz (ft/day)	0.012	0.031	3	10	0.08	6	9

**Table 3 Summary statistics for particle tracking results for TSF3 – Base Case**

Unit	Limestone	Dacite	Alluvium
<b>Model Zone Number</b>	<b>11</b>	<b>19 and 40</b>	<b>22</b>
Travel Distance (ft)	2,412	5,607	294
Travel Time (days)	3,164	20,408	239
Travel Time (years)	8.7	56	0.7
Velocity (ft/day)	0.76	0.27	1.2

**Table 4 Summary statistics for particle tracking results for TSF3 – Sensitivity run with low effective porosity**

Unit	Limestone	Dacite	Alluvium
<b>Model Zone Number</b>	<b>11</b>	<b>19 and 40</b>	<b>22</b>
Travel Distance (ft)	2,385	5,438	66
Travel Time (days)	1,446	8,178	144
Travel Time (years)	4.0	22.4	0.4
Velocity (ft/day)	1.6	0.7	0.5

**Table 5 Summary statistics for particle tracking results for TSF4 – Base case**

Unit	Dacite	Gila	Tailings	Dacite	Gila	Dacite	Alluvium
<b>Model Zone Number</b>	<b>19</b>	<b>20</b>	<b>25</b>	<b>19 and 40</b>	<b>39</b>	<b>19 and 40</b>	<b>22</b>
Travel Distance (ft)	60	1,557	1,468	7,930	650	491	108
Travel Time (days)	193	1,308	203	11,550	1,099	1,001	236
Travel Time (years)	0.5	3.6	0.6	32	3.0	2.7	0.6
Velocity (ft/day)	0.31	1.19	7.23	0.69	0.59	0.49	0.46

**Table 6 Summary statistics for particle tracking results for TSF4 –Sensitivity run with low effective porosity**

Unit	Dacite	Gila	Tailings	Dacite	Gila	Dacite	Alluvium
<b>Model Zone Number</b>	<b>19</b>	<b>20</b>	<b>25</b>	<b>19 and 40</b>	<b>39</b>	<b>19 and 40</b>	<b>22</b>
Travel Distance (ft)	54	1,550	1,353	7,812	628	395	197
Travel Time (days)	86	658	95	7,164	260	187	116
Travel Time (years)	0.2	1.8	0.3	19.6	0.7	0.5	0.3
Velocity (ft/day)	0.62	2.36	14.26	1.09	2.42	2.11	1.70

## Figures

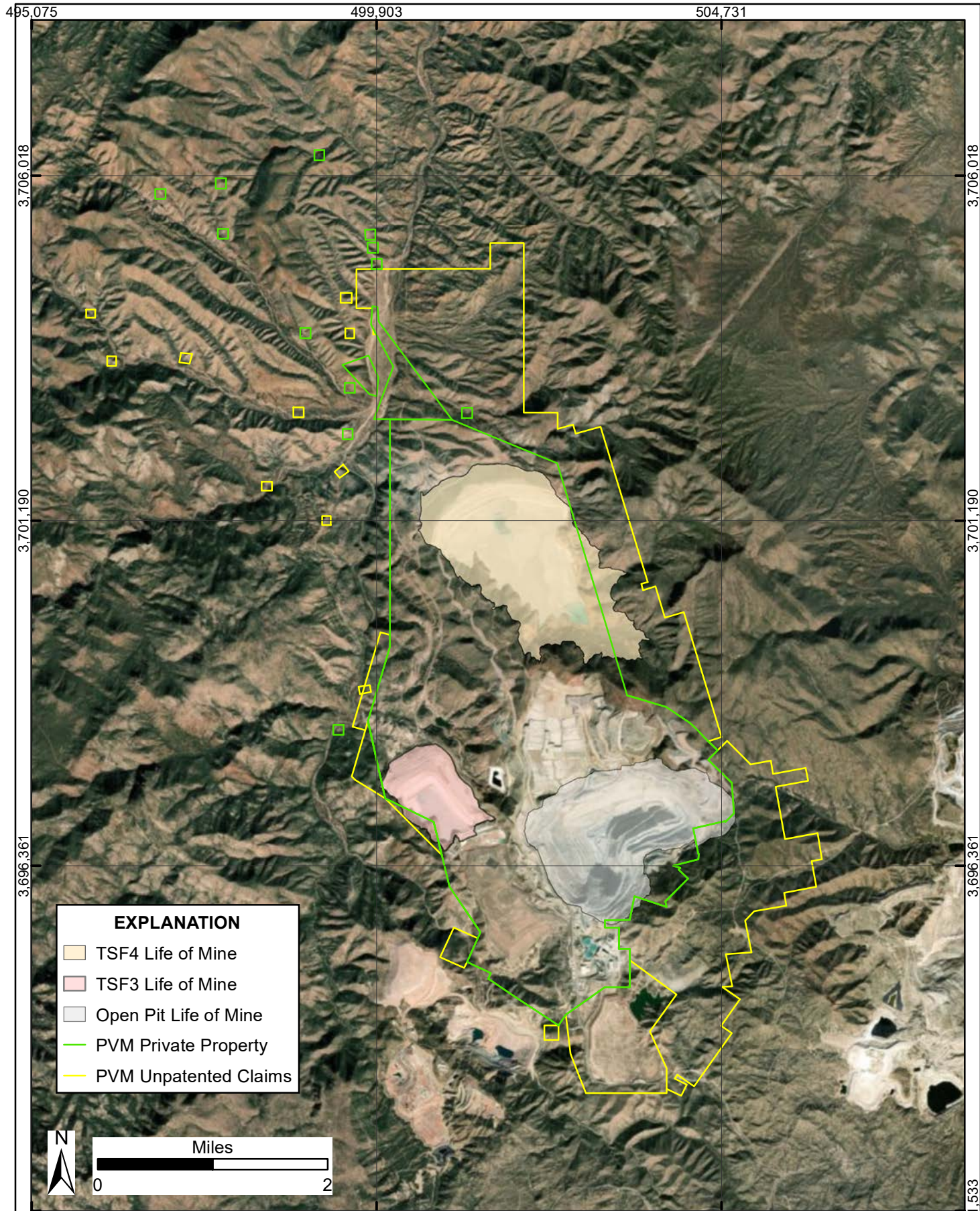

EXPLANATION	
	TSF4 Life of Mine
	TSF3 Life of Mine
	Open Pit Life of Mine
	PVM Private Property
	PVM Unpatented Claims

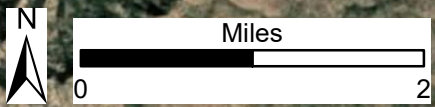

		<h1>SITE LOCATION MAP</h1>		DRAWING TITLE: <b>POST-CLOSURE TAILINGS SEEPAGE MANAGEMENT AND MITIGATION PLAN</b>	
				ISSUED FOR: <b>PINTO VALLEY MINING CORP</b>	
NAD 1983 UTM Zone 12N		DESIGN:      DRAWN:      REVIEWED: <b>VS</b>		DRAWING NO. <b>FIGURE 1</b> REVISION NO.	
SCALE:      1 inch = 5,909 feet      DATE: <b>6/10/2020</b>		FILE: <b>Fig01_GeneralLocationMap.mxd</b>		SRK JOB NO. <b>219500.590</b>	
PATH: P:\Capstone_Mining\050_GIS\Tailings Seepage\Fig01_GeneralLocationMapBaseMap		Source: Source: Esri, DigitalGlobe, GeoEye, Earthstar Geographics, CNES/Airbus DS, USDA, USGS, AeroGRID, IGN, and the GIS User Community		<h1>A</h1>	

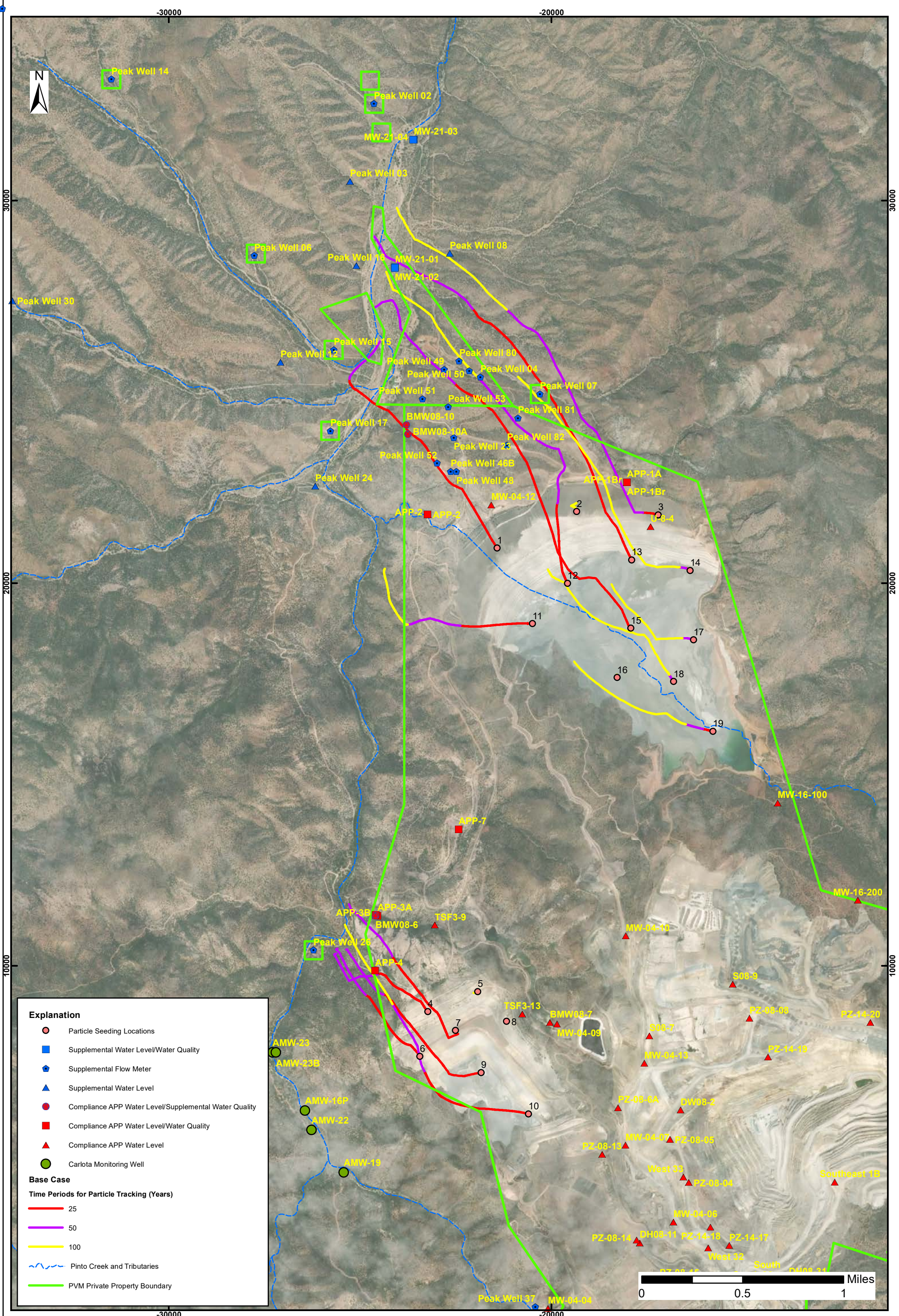

**Explanation**

- Particle Seeding Locations
- Supplemental Water Level/Water Quality
- ◆ Supplemental Flow Meter
- ▲ Supplemental Water Level
- Compliance APP Water Level/Supplemental Water Quality
- Compliance APP Water Level/Water Quality
- ▲ Compliance APP Water Level
- Carlota Monitoring Well

**Base Case**

**Time Periods for Particle Tracking (Years)**

- 25
- 50
- 100

- Pinto Creek and Tributaries
- PVM Private Property Boundary



GRID:	Inspiration Mine Coordinates, ft.		
DESIGN:	KM	DRAWN:	KM
SCALE:	1 inch = 2,236 feet		REVIEWED:
FILE:	DATE: 6/12/2020		
	Figs2-3_Particle Track_Rev03.mxd		

**PARTICLE TRACK RESULTS FROM THE END OF MINING - BASE CASE**

POST-CLOSURE TAILINGS SEEPAGE MANAGEMENT AND MITIGATION PLAN

ISSUED FOR:	PINTO VALLEY MINING CORP	
	<b>FIGURE 2</b>	REVISION NO.
SRK JOB NO.	219500.590	<b>A</b>

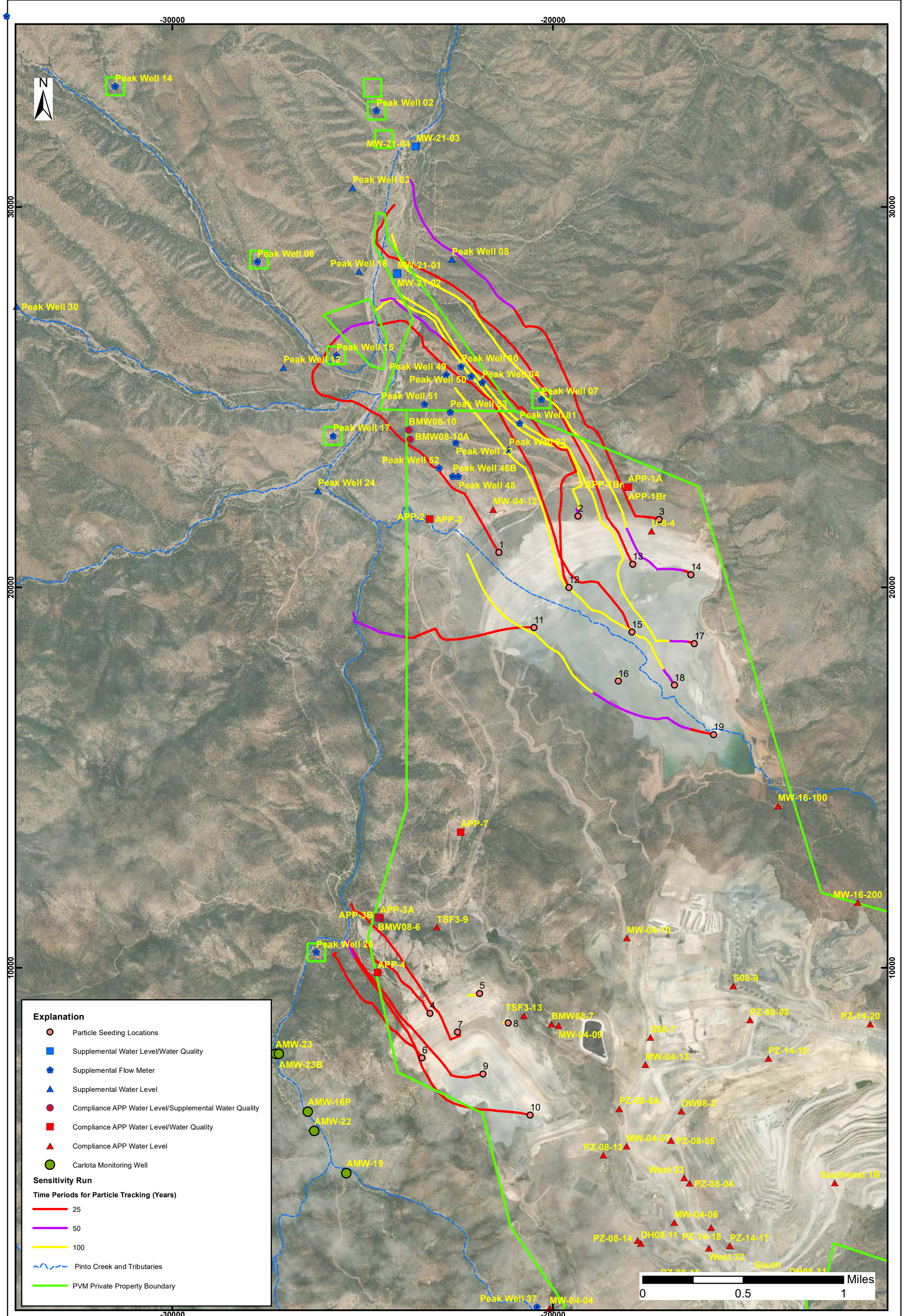

**Explanation**

- Particle Seeding Locations
- Supplemental Water Level/Water Quality
- ◆ Supplemental Flow Meter
- ▲ Supplemental Water Level
- Compliance APP Water Level/Supplemental Water Quality
- Compliance APP Water Level/Water Quality
- ▲ Compliance APP Water Level
- Carlota Monitoring Well

**Sensitivity Run**

Time Periods for Particle Tracking (Years)

- 25
- 50
- 100

- Pinto Creek and Tributaries
- PVM Private Property Boundary



GRID:	Inspiration Mine Coordinates, ft.		
DESIGN:	KM	DRAWN:	KM
SCALE:	1 inch = 2,236 feet		REVIEWED:
FILE:	Figs2-3_Particle Track_Rev03.mxd		DATE:
			6/12/2020
			CKH

**PARTICLE TRACK RESULTS FROM THE END OF MINING - SENSITIVITY RUN (LOW EFFECTIVE POROSITY)**

POST-CLOSURE TAILINGS SEEPAGE MANAGEMENT AND MITIGATION PLAN

ISSUED FOR: PINTO VALLEY MINING CORP

FIGURE 3

SRK JOB NO. 219500.590

REVISION NO. **A**

# Base Case Particle Trajectory

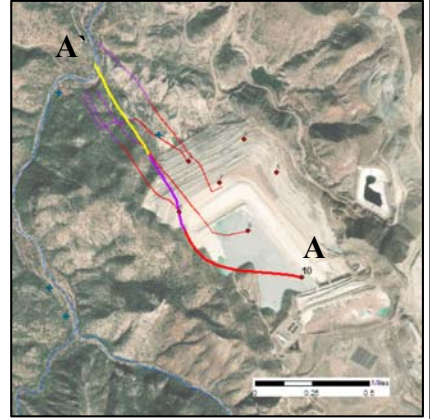
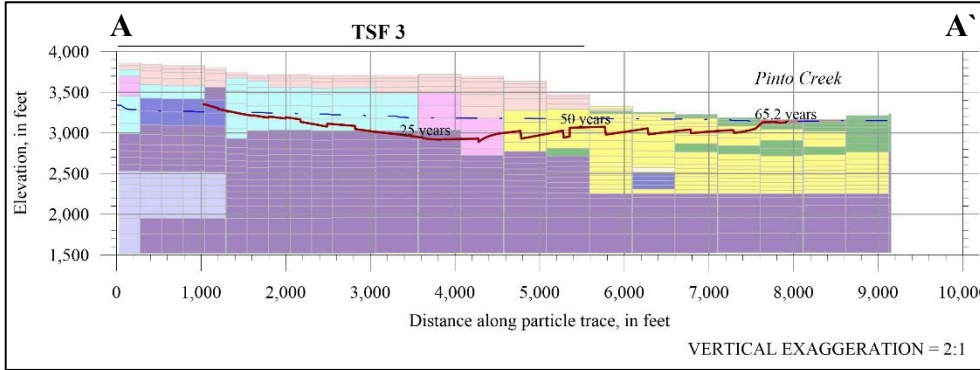

Looking Southwest

# Sensitivity Case Particle Trajectory

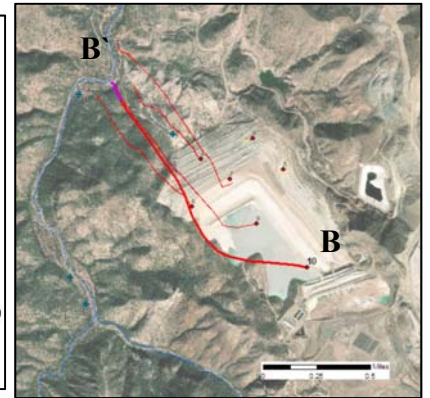
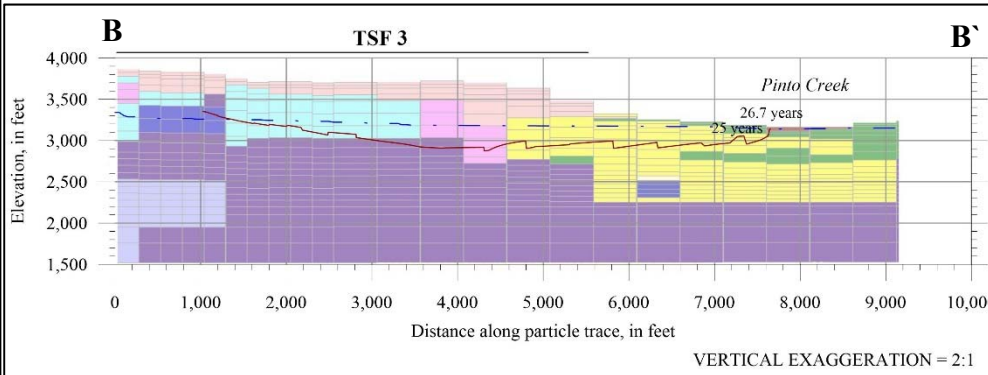

Looking Southwest

**Explanation**

Pinal Schist	Dacite (Productive Zone)
Quartz Monzonite	Alluvium
Leach Pad	Ruin Granite
Limestone	Dacite - North
Tailings Impoundment	Bedrock Beneath Conglomerate
Whitetail Conglomerate	Bedrock Beneath Alluvium
Diabase	Simulated Water Table (100 years Post Closure)
Gila Conglomerate (Productive Zone)	

**Explanation**

- Particle Seeding Locations

**Time Periods for Particle Tracking (Years)**

- 25
- 50
- 100
- Pinto Creek and Tributaries

Job No: 219500.590  
 Filename: Figure xxxx.pptx

PINTO VALLEY MINE

POST-CLOSURE TAILINGS SEEPAGE MANAGEMENT AND MITIGATION PLAN

TSF3 PARTICLE TRACK PROFILE – BASE (TOP) AND SENSITIVITY (LOWER)

Date: JUNE 2020	Approved: CH	Figure: 4
-----------------	--------------	-----------

# Base Case Particle Trajectory

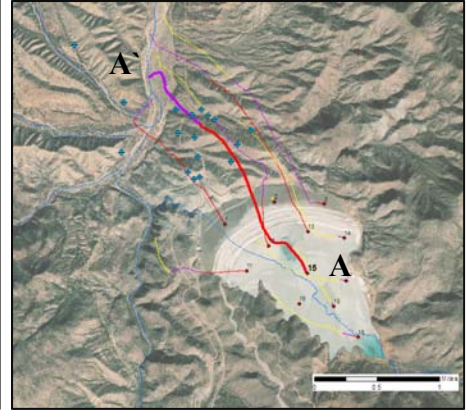
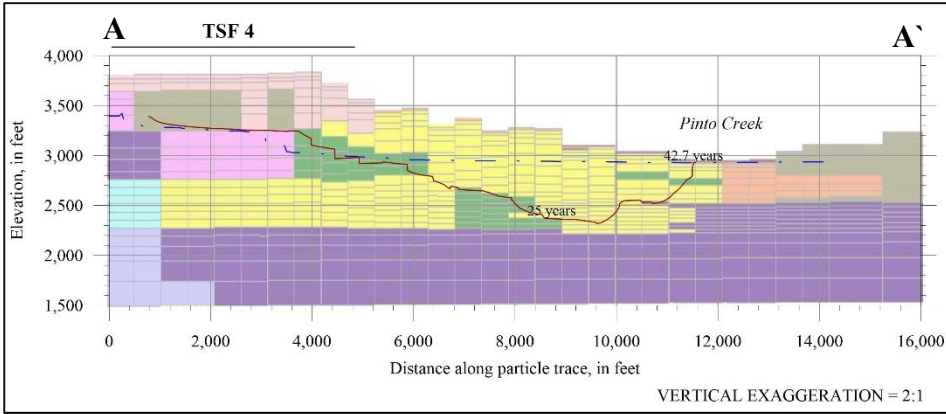

Looking Southwest

# Sensitivity Case Particle Trajectory

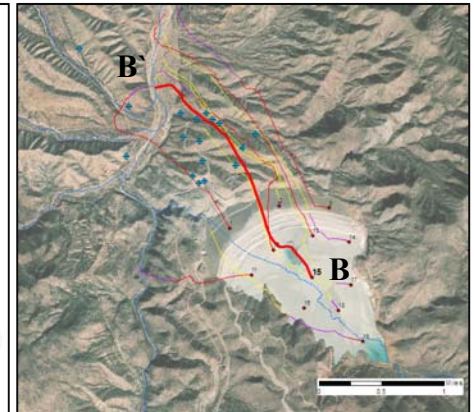
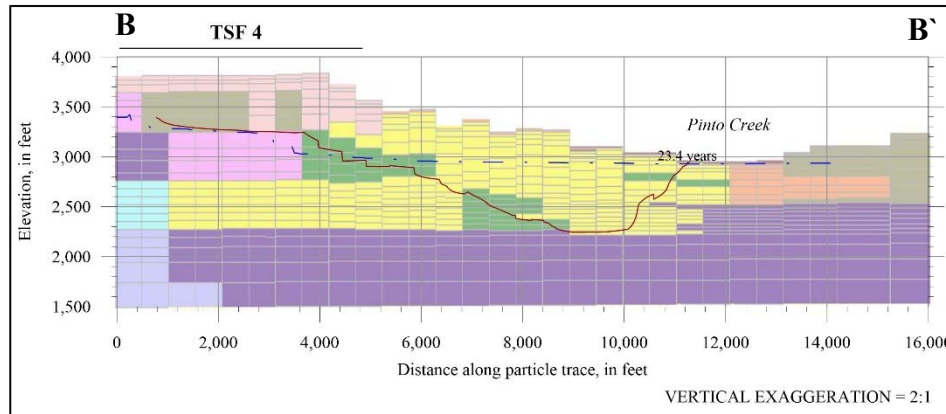

Looking Southwest

**Explanation**

Pinal Schist	Dacite (Productive Zone)
Quartz Monzonite	Alluvium
Leach Pad	Ruin Granite
Limestone	Dacite – North
Tailings Impoundment	Bedrock Beneath Conglomerate
Whitetail Conglomerate	Bedrock Beneath Alluvium
Diabase	Simulated Water Table (100 years Post Closure)
Gila Conglomerate (Productive Zone)	

**Explanation**

- Particle Seeding Locations

**Time Periods for Particle Tracking (Years)**

- 25
- 50
- 100
- Pinto Creek and Tributaries

Job No: 219500.590  
 Filename: Figure xxxx.pptx

PINTO VALLEY MINE

POST-CLOSURE TAILINGS SEEPAGE MANAGEMENT AND MITIGATION PLAN

TSF4 PARTICLE TRACK PROFILE – BASE (TOP) AND SENSITIVITY (LOWER)

Date: JUNE 2020	Approved: CH	Figure: 5
-----------------	--------------	-----------



498,898

500,507

3,698,280

3,698,280

3,696,671

3,696,671

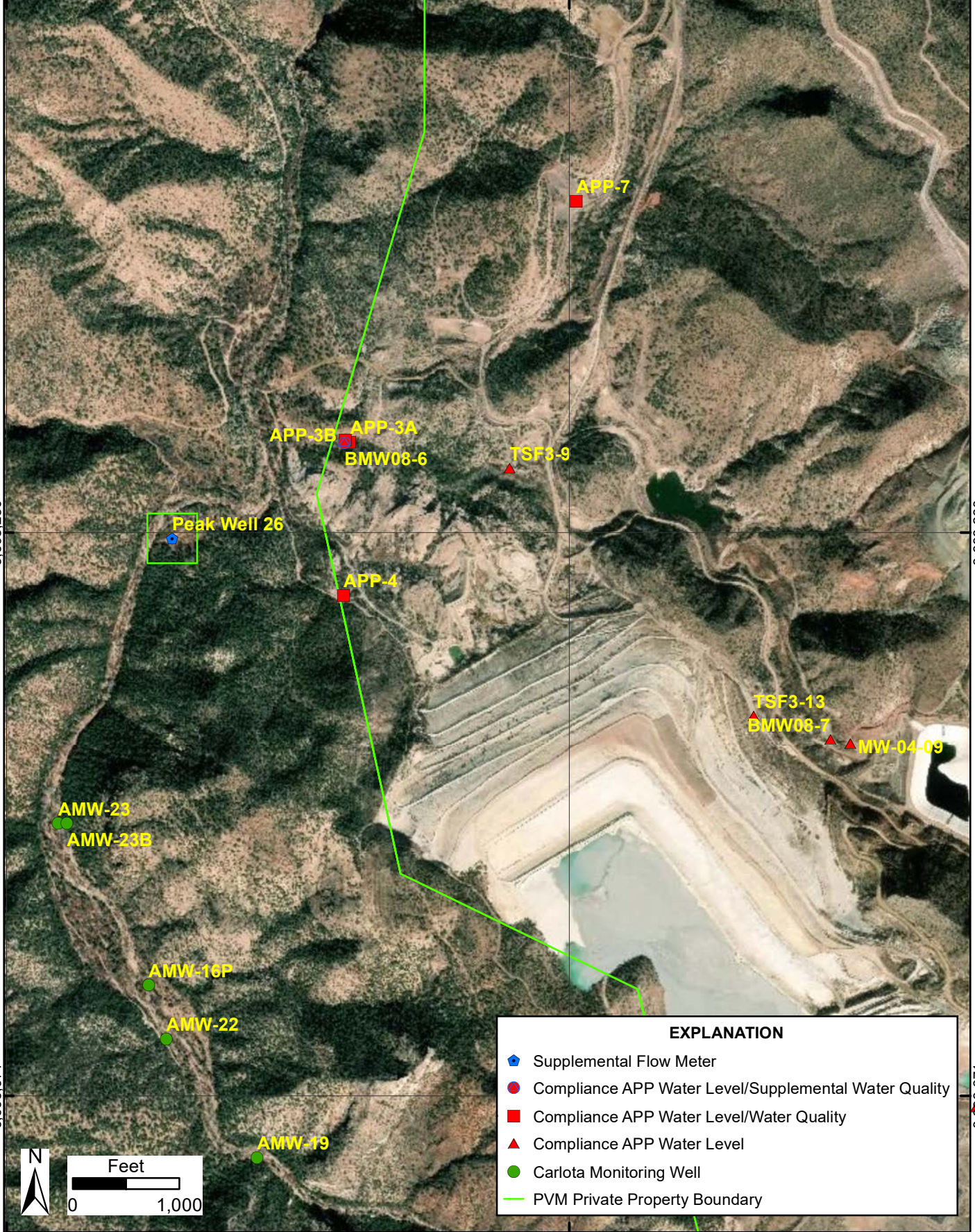

EXPLANATION	
	Supplemental Flow Meter
	Compliance APP Water Level/Supplemental Water Quality
	Compliance APP Water Level/Water Quality
	Compliance APP Water Level
	Carlota Monitoring Well
	PVM Private Property Boundary

498,898

500,507



### WELLS DOWNGRADIENT OF TSF3

NAD 1983 UTM Zone 12N		
DESIGN:	DRAWN:	REVIEWED: VS
SCALE: 1 inch = 1,250 feet	DATE: 6/9/2020	
FILE: MonitoringWells_Figure_Rev02_TSF3.mxd		

DRAWING TITLE: POST-CLOSURE TAILINGS SEEPAGE MANAGEMENT AND MITIGATION PLAN	
ISSUED FOR: PINTO VALLEY MINING CORP	
DRAWING NO. <b>FIGURE 6</b>	REVISION NO.
SRK JOB NO. 219500.590	<b>A</b>

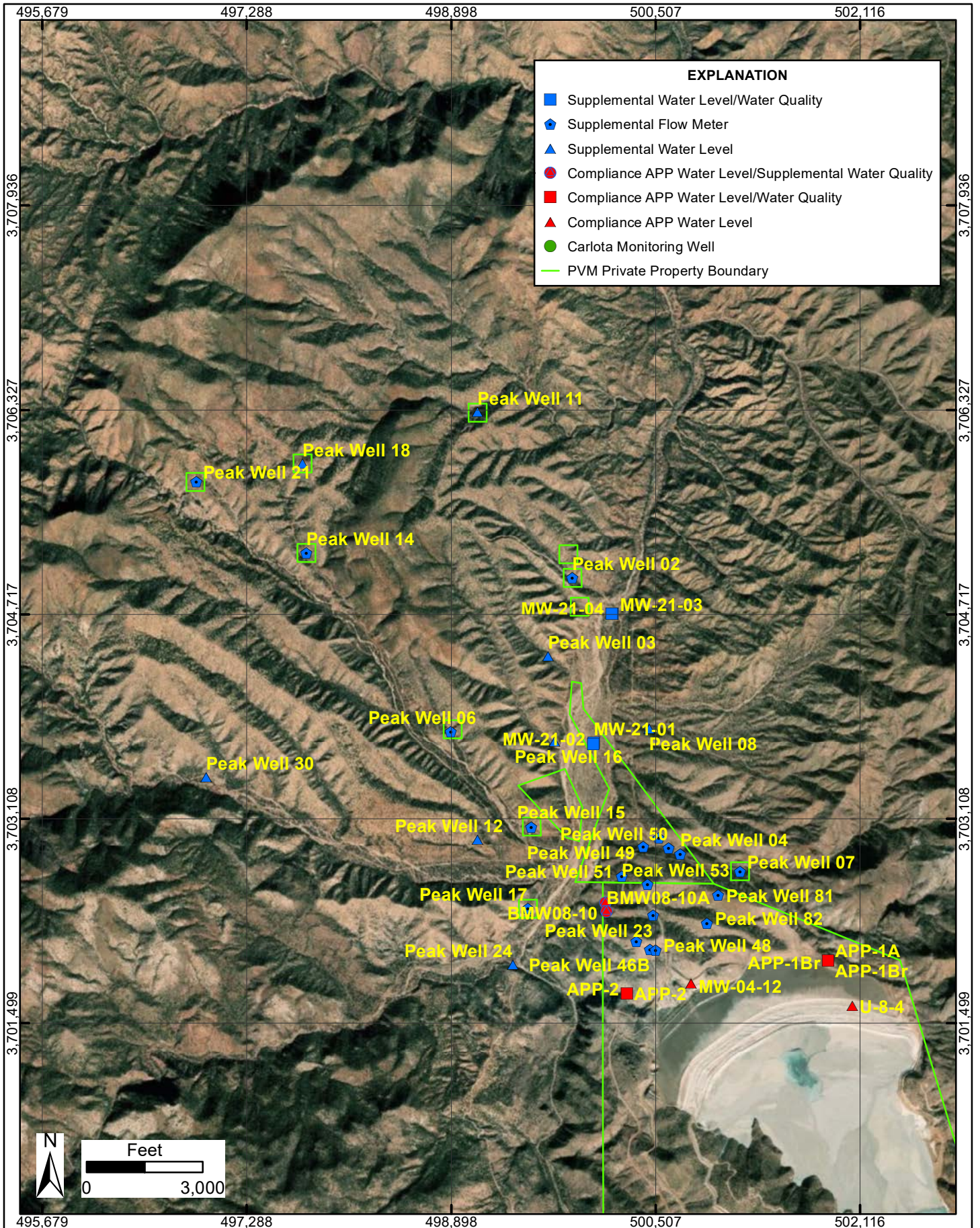

**srk consulting**

NAD 1983 UTM Zone 12N

DESIGN:	DRAWN:	REVIEWED:	VS
SCALE:	1 inch = 3,333 feet		DATE: 6/9/2020
FILE: MonitoringWells_Figure_Rev02_TSF4.mxd			

## WELLS DOWNGRADIENT OF TSF4

DRAWING TITLE: POST-CLOSURE TAILINGS SEEPAGE MANAGEMENT AND MITIGATION PLAN	
ISSUED FOR: PINTO VALLEY MINING CORP	
DRAWING NO. <b>FIGURE 7</b>	REVISION NO.
SRK JOB NO. <b>219500.590</b>	<b>A</b>

PATH: P:\Capstone\_Mining\050\_GIS\Tailings Seepage\MonitoringWells\_Figure\_Rev02\_TSF4.mxd Source: Esri, DigitalGlobe, GeoEye, Earthstar Geographics, CNES/Airbus DS, USDA, USGS, AeroGRID, IGN, and the GIS User Community

## **Appendix A: Background Information and Mitigation Plan**

SRK Consulting (U.S.), Inc.

## Technical Memo

---

<b>To:</b>	Timothy Ralston	<b>Date:</b>	June 12, 2020
<b>Company:</b>	Pinto Valley Mining Corp.	<b>From:</b>	Corolla Hoag, P.G.
<b>Copy to:</b>	File	<b>Project #:</b>	219500-590
<b>Subject:</b>	Background Information Supporting Post-Closure Tailings Seepage Management Plan		

---

### Introduction

Pinto Valley Mine (PVM) is an active copper sulfide mine and, as such, and operates a wellfield, reservoirs, and other facilities to provide water for processing and tailings disposal operations. Tailings Storage Facility No. 3 (TSF3) and No. 4 (TSF4) will be active during the remaining life of mine (LOM) (Proposed Action) described in the *Pinto Valley Mine Draft Environmental Impact Statement* (EIS) issued December 13, 2019. The LOM design would extend a portion of the footprint of TSF3 west of the existing facility and a portion of TSF4 southeast of the existing footprint into Upper Eastwater Canyon onto National Forest System land administered by the U.S. Forest Service (USFS), Tonto National Forest (TNF). Tailings would be retained on private Pinto Valley Mining Corp. (PVMC) land if the mine life is truncated under a No Action scenario. At closure, the TSFs will drain for approximately 10 years to allow mobile equipment safe access to the impoundment surface prior to the onset of reclamation construction earthworks.

In the Draft EIS, TNF identified circumstances for which mitigation measures could be used to minimize potential adverse environmental impacts associated with the Proposed Action including post-closure tailings seepage. In response, PVMC commissioned SRK Consulting (SRK) to prepare a *Pinto Valley Mine – Post-closure Tailings Seepage Management and Mitigation Plan* (Plan). The background information summarized below supports the Plan.

### 1 Estimated Tailings Seepage Rates During Operations and Post-Closure

The artificial recharge to the groundwater system from TSF3 and TSF4 [and the older closed/reclaimed TSF1 and TSF2] represents porewater draindown fluids moving into the underlying groundwater system. The initial estimates of draindown recharge were based on work completed by Hargis and Associates (Hargis, 1995) to support the initial area-wide Aquifer Protection Permit (APP). TSF3 has been used as an occasional backup for TSF4 since 1988 and will continue to be used as a backup. The artificial recharge from TSF3 is negligible and the facility has been in a dominantly draindown mode since 1988 relative to the seepage discharging to groundwater from TSF4, which has been under near-continuous use since the start of 2013.

Amec Foster Wheeler (AFW, now Wood) (AFW, 2017a) and SRK (SRK, 2019) modeled seepage draindown during operations and closure as part of SRK's groundwater modeling work to support PVM's EIS. SRK applied a temporal draindown relationship developed for TSF1 and TSF2 by AFW to the dominantly inactive facility TSF3. AFW developed an exponential decay curve for TSF1 and TSF2 based on their long-term monitoring of draindown using the instrumented piezometers in these facilities. SRK applied AFW's exponential draindown decay curve for TSF1 and TSF2 to the artificial

recharge for TSF3 based on the (1) initial estimates of Hargis (1995) for the facilities, (2) the draindown measurements documented by AFW in the TSF piezometers, and (3) unsaturated flow principles and the fact that 30 years had elapsed since these facilities were active. SRK selected recharge values from the exponential curves shown in Figure 1 to represent specific time periods in the model. SRK applied the following range of seepage rates for these inactive (or dominantly inactive) facilities at the selected intervals below:

- Approximately 13.7 to 20.8 in/yr at the end of groundwater modeling Steady State conditions (2011 to 2012);
- Exponentially decreasing from 13.7 to 20.8 in/year at the end of 2012 to 9.2 to 13.9 in/yr under current conditions (assumed to be 2018);
- Exponentially decreasing from 9.2 to 13.9 in/yr at the end of 2018 to 5.0 to 7.6 in/yr in year 2027;
- Exponentially decreasing from 5 to 7.6 in/yr at the end of 2027 to 2.3 to 3.5 in/yr in year 2039; and
- Exponentially decreasing during the site-wide post-closure period until seepage reaches natural recharge from precipitation (0.4 to 0.9 in/yr).

Seepage from TSF4 is a primary source of artificial recharge to the bedrock groundwater system that is hydrologically connected to the Peak wellfield. The continued extension of the TSF4 footprint as tailings are added and the ponded water level rises is represented in both scenarios by applying average recharge to the entire footprint area of the facility. As the footprint area increases, the recharge rate increases; recharge rates will decrease through the post-closure period.

Seepage from specific areas within TSF4 is estimated to range from 22 in/yr to 273 in/yr based on the analyses by Hargis (1995) and AFW (2017a). The basis for the draindown and seepage estimates during the operations and post-closure periods under the Proposed Action was described in a technical memorandum that was submitted to ADEQ during the APP amendment process to permit the tailings extension (AFW, 2017a). AFW considered factors such as the physical properties of the tailings materials (i.e., sands, slimes), the tailings application rates and volume of water in the tailings slurry, and the draindown rates and water levels recorded in different areas by piezometers in the historical and current tailings.

AFW provided SRK with the minimum, maximum, and average annual infiltration rates expected during the future TSF4 construction and draindown periods for the Proposed Action (AFW, 2017b; SRK, 2018b). SRK (2019) applied the following average annual seepage rates to TSF4 in the groundwater model:

- Approximately 40 in/yr in 2011 to 2012 (groundwater model steady state period);
- Linearly increasing from 40 in/year at end of 2012 to 57 in/yr under current conditions in 2018;
- Linearly increasing from 57 in/yr at the end of 2018 to 76 in/yr in year 2034;
- Linearly decreasing from 76 in/yr at the end of 2034 to 72 in/yr in year 2039 (end of processing); and
- Exponentially decreasing post-mining until seepage reaches natural recharge from precipitation.

SRK confirmed the appropriateness of using a linear increase in TSF4 seepage rates for the Proposed Action in the groundwater model in a discussion with the Wood engineer of record (T.

Freiman, personal commun. February 2019). Wood also endorsed using the relative rate of seepage increase for the No Action scenario. For the No Action scenario, therefore, SRK increased tailings seepage linearly from 57 in/year at the end of 2018 to a peak of 66 in/yr in approximately year 2024 and then tapered the seepage through year 2027 following the same relative seepage rate decline used in the last few years of tailings deposition under the Proposed Action. Draindown from TSF4 is expected to be the primary source of artificial recharge to the groundwater system at PVM during the post-closure period.

## 2 Tailings Reclaim Water Quality

The sloping design of the tailings impoundment (top surface) ensures that a water pool (called reclaim water or supernatant) forms at the upstream end of the impoundment away from the tailings dam (embankment). The reclaim water is pumped for reuse in the mill and plant facilities. Water quality data from 1993 through 2014 are presented in Table 1 for major and trace elements, total dissolved solids, and pH for samples of tailings reclaim water from TSF4 and TSF3 and a blended sample from both TSFs. The water quality results for specific constituents show some variability and likely bracket the minimum and maximum results expected for the remaining life of mine (LoM) under both mining scenarios. This is because the host rocks and copper sulfide ore will be similar to what was mined previously and there are no relevant changes planned in the mill/concentrator processing circuit.

The supernatant fluid is near neutral to alkaline with pH values ranging from 7.2 to 10. The dominant constituents are total dissolved solids (TDS), sulfate, bicarbonate, calcium, magnesium, sodium, and potassium. The results can be compared to reference Arizona surface water quality standards, it is important to note that there are no numeric standards for tailings water and that PVM tailings water is not a source of drinking water. In the seven measurements taken from 1993 to 2020, there has been an increase in fluoride concentrations. There was also one elevated measurement in the concentration of manganese with respect to reference Arizona Administrative Code R18-11 Agricultural Irrigation (Agl) standards (Table 1). These constituents have not been measured in elevated concentrations in the Point-of-Compliance (POC) spring monitoring locations or in the POC groundwater monitoring wells downgradient of TSF3 and TSF4.

With respect to reference AAC AgI standards, dissolved manganese (10 mg/L) was elevated in TSF4 water in 1999 (14 mg/L) and total manganese (10 mg/L) was elevated in TSF4 water in 1999 (15 mg/L) and TSF3 water in 1994 (10.1 mg/L). Current analysis of manganese in both the TSF4 and TSF3 samples do not show elevated concentrations. Analysis results do not exceed 0.018 mg/L in the 2016 or the 2020 samples.

## 3 Groundwater Quality Downgradient of the TSFs

Groundwater quality downgradient of TSF3 and TSF4 has been routinely monitored in the APP POC groundwater wells and springs for common ions, total and trace metals, and radiochemicals since 1994. There are Aquifer Quality Limits (AQLs) and Alert Levels (ALs) established in the APP for these monitoring sites; the AQLs are based on the Arizona Aquifer Water Quality Standards (AWQSs).

Summaries of the groundwater quality results downgradient of TSF4 for APP-1A (screened 90-190 ft below ground surface (bgs) in Gila Conglomerate), APP-1Br (screened 370-450 ft bgs in quartzite), and APP-2 (screened 140-240 ft bgs in dacite) are presented in Table 2, Table 3 and Table 4

respectively. The tables list the number of samples at each well by constituent and the maximum, minimum values measured, and then compares the results against numeric site AQLs, which are based on (AWQSSs). The tables document compliance at the POC wells downgradient of TSF4 with the site AQLs. The groundwater at these monitoring points is near neutral; the dominant constituents are TDS, sulfate, magnesium, and sodium. Trace metals and radiochemicals are below their respective AQLs and below the AWQSSs. Sulfate and TDS are elevated. As described above, no change to groundwater quality within the range of results already seen during operations and temporary cessation conditions is expected at the established POC monitoring points because of the extension up canyon of tailings materials into higher reaches of Eastwater Canyon.

TSF3 has dominantly been in a draindown period since 1988 with infrequent use planned for the remaining LoM. After tailings deposition ceases in 2039, both TSFs will complete a long-term draindown process that will be monitored so that construction can safely begin when drainage conditions are sufficient at each TSF. The residual tailings porewater will drain until the top surface of the TSF4 is sufficiently stable to support closure earthworks regrading equipment during the first 10 years of the site-wide post-closure period from approximately 2040 to 2050; draindown may be completed earlier for TSF3. The closure strategy for both TSFs is to regrade the facilities to shed stormwater (rather than impound it) and cover the top surface and embankment with local borrow materials that will minimize dust and support post-closure land uses. Revegetation, once established and mature as seen on the reclaimed TSF1, will further reduce infiltration and generation of on-going tailings drainage owing to evapotranspirative processes. Concentrations measured at the POC wells of tailings-indicator parameters (i.e., elevated sulfate, TDS) are expected to peak during operations and decline during the post-closure period owing to the slow but eventual dissipation of the residual tailings water and dilution by groundwater.

#### **4 Wellfield Extraction Rates Downgradient of the TSFs**

PVMC operates the Peak wellfield as a source of water for processing and routine operations at PVM. The majority of the Peak wells are downgradient of TSF4; the average pumping rate for the entire wellfield is approximately 2,831 gpm including wells located west of Pinto Creek at a significant distance from TSF4. The total average pumping rate in Q1 2020 was approximately 524 gpm for Peak Well 26 located immediately downgradient of TSF3 and 2,307 gpm for 16 wells located immediately downgradient of TSF4 (AJAX, 2020). Note that in any one quarter one or more wells may be non-producing for various reasons. PVMC anticipates that the annual water demand and flow rates from the Peak wellfield and other sources at PVM will remain approximately the same for the LoM under both mining scenarios. There are established wells for APP-related compliance water level and water quality monitoring downgradient of TSF3 (see Figure 2) and TSF4 (Figure 3) and supplemental monitoring of the water levels and flow rates in the Peak wellfield area (PVMC, 2020).

As discussed in Section 1, artificial recharge to the groundwater system occurs from seepage to groundwater from tailings water entrained in the pores of finely ground rock materials in the active and inactive tailings facilities. TSF4 is the main source of on-going and future artificial recharge to the local groundwater system. The local groundwater table currently mounds beneath TSF4, and the tailings water is providing water to the local system as confirmed by the elevated sulfate analyzed in the Peak wells. The groundwater quality sample results are elevated moderately to significantly above background sulfate values immediately downgradient of TSF4 confirming tailings draindown is a significant contributor to the water pumped from the Peak wells (SRK, 2018a). TSF3, planned for

occasional use through the remaining LoM under both scenarios, is dominantly in a draindown mode relative to ongoing infiltration / seepage from TSF4.

## 5 References

- AJAX, 2020, Technical memorandum: Well instrumentation report for first quarter 2020: unpublished report prepared for Pinto Valley Mining Corp., April 30, 2020, 15 p.
- Amec Foster Wheeler, 2017, Hydrologic and hydraulic analysis, Pinto Valley Mine – Tailings Storage Facility No. 4 extension, Drainage report for operations and closure: unpublished report prepared for Pinto Valley Mining Corp., March 28, 2017, 21 p., 9 exhibits, 2 appendices.
- Hargis + Associates (Hargis), 1995, Preliminary hydrogeologic report: unpublished report prepared for Magma Copper Company, Pinto Valley Mining Division, Miami, Arizona, January 13, 1995, 185 p.
- Pinto Valley Mining Corp., 2020, Pinto Valley Mine – Comprehensive Water Resources Monitoring and Mitigation Plan: unpublished plan submitted as part of the EIS, May 29, 2020, 39 p., 3 appendices.
- SRK Consulting (SRK), 2019, Pinto Valley Mine – Groundwater modeling for mine extension (Revised): unpublished report prepared for BHP Copper Inc., May 3, 2019, 181 p., 2 appendices.



## Tables

**Table 1 Water quality analyses for TSF3 and TSF4 reclaim water**

Parameter (mg/L unless noted)	Arizona Administrative Code (AAC) R18-11					Blended Reclaim 4/9/1993	TSF4 Reclaim Water 6/4/1999	TSF3 Reclaim Water 7/13/1994	TSF3 Reclaim Water 2/8/2013	Met Test Supernatant 1/12/2015	TSF4 Reclaim Water 3/3/2016	TSF4 Reclaim Water 5/5/2020
	FC <sup>1</sup>	FBC <sup>2</sup>	A&Wc Acute <sup>3</sup>	AgI <sup>4</sup>	AgL <sup>5</sup>							
Matrix						TSF4 Reclaim water	TSF4 Reclaim water	TSF3 Reclaim water	TSF3 Reclaim water	Met Test liquid	TSF4 Reclaim water	TSF4 Reclaim water
Alkalinity as HCO <sub>3</sub>							46	116				
Alkalinity, Total, as CaCO <sub>3</sub>								116			12.9	21
Aluminum, Dissolved							<0.5			0.11		0.25
Aluminum, Total							1.9	<0.05				
Antimony, Dissolved			0.088				<0.05			0.0011	<0.020	0.025
Antimony, Total	0.64	0.747					<0.05	<0.05				
Arsenic, Dissolved			0.34				<0.05			0.0003	<0.025	0.0036
Arsenic, Total	0.08	0.03		2	0.2		<0.05	<0.005			<0.025	
Barium, Dissolved							0.013			0.015		0.049
Barium, Total		187					0.017	0.094				
Beryllium, Dissolved			0.065				<0.005			<0.00005	<0.0020	<0.0005
Beryllium, Total	0.084	1.87					<0.005	<0.005			<0.0020	
Boron, Total		187		1				0.1				
Cadmium, Dissolved			0.005	0.05	0.05	<0.0005	<0.005			<0.0001	<0.00020	0.000089
Cadmium, Total	0.006	0.467		0.05	0.05	<0.0005	<0.005	<0.0005			<0.00020	
Calcium, Dissolved							380			17.8		650
Calcium, Total							430	463			591	
Chromium, Dissolved							<0.01			<0.01	<0.0060	<0.43
Chromium, Total				1	1		<0.01	<0.01			<0.0060	
Cobalt, Dissolved							0.059			<0.01	<0.0060	
Cobalt, Total							0.07	0.017				
Copper, Dissolved			0.034			<0.01	<0.02			<0.01	<0.0100	
Copper, Total		1.3		5	0.5	0.191	<0.02	<0.01			<0.0100	
Cyanide, Total	0.504	0.588	0.022		0.2		<0.02	<0.01			0.016	
Iron, Dissolved							<0.5			<0.02	<0.060	0.041
Iron, Total							1.4	13.2			0.17	
Lead, Dissolved						<0.002	<0.05			0.0001	<0.00300	
Lead, Total		0.015		10	0.1	<0.002	<0.05	<0.002			<0.00300	
Lithium, Total								0.03		<0.008		
Magnesium, Dissolved							93			2.7		
Magnesium, Total							100	34.4			3.46	
Manganese, Dissolved		131		10			<b>14</b>			<0.005	0.0097	0.018
Manganese, Total		131		10			<b>15</b>	<b>10.1</b>			0.0158	
Mercury, Dissolved			0.002				<0.0002			<0.0002	0.00028	
Mercury, Total		0.28			0.01	<0.0002	<0.0002	<0.0002			0.0008	

**Table 1 Water quality analyses for TSF3 and TSF4 reclaim water (Continued)**

Parameter (mg/L unless noted)	Arizona Administrative Code (AAC) R18-11					Blended Reclaim 4/9/1993	TSF4 Reclaim Water 6/4/1999	TSF3 Reclaim Water 7/13/1994	TSF3 Reclaim Water 2/8/2013	Met Test Supernatant 1/12/2015	TSF4 Reclaim Water 3/3/2016	TSF4 Reclaim Water 5/5/2020
	FC <sup>1</sup>	FBC <sup>2</sup>	A&Wc Acute <sup>3</sup>	AgI <sup>4</sup>	AgL <sup>5</sup>							
Matrix						TSF4 Reclaim water	TSF4 Reclaim water	TSF3 Reclaim water	TSF3 Reclaim water	Met Test liquid	TSF4 Reclaim water	TSF4 Reclaim water
Molybdenum, Total								0.18		0.08		
Nickel, Dissolved			0.012				<0.25			<0.008	<0.0100	
Nickel, Total	0.511	28					0.14	<0.02			<0.0100	
Phosphorus, dissolved										<0.1		
Potassium, Dissolved							24			13.9		150
Potassium, Total							23	16				
Selenium, Dissolved							<0.06			0.006	0.103	
Selenium, Total	0.667	4.67		0.02	0.05		<0.06	<0.005			0.0965	0.052
Silicon, dissolved										2.1		
Silver, Total	8	4.67						<0.01		<0.0005		<0.003
Sodium, Dissolved							110			8.4		
Sodium, Total							90	126				120
Strontium, Total								1.92		0.059		1.3
Thallium, Dissolved			0.7				<0.05			<0.0001		0.0002
Thallium, Total	0.0001	0.009					<0.05	<0.005				
Tin, Total								<0.03				
Uranium, dissolved		2.8								0.0026		
Vanadium, Total								<0.01				
Zinc, Dissolved			0.046			<0.01	<0.05			<0.01	<0.010	0.0037
Zinc, Total	5.106	280		10	25	0.026	<0.05	0.119			<0.010	
Carbonate as CaCO <sub>3</sub>							<5			<2		12
Chloride							78	72		7.1		87
Fluoride, Dissolved		140					4.3		11.7	11.1	6.55	12
Fluoride, Total		140						0.42				
Hardness, Total as CaCO <sub>3</sub>						1570		1300			1490	
Nitrate + Nitrite, as Nitrogen							4.2			0.1	5.82	2.1
Nitrate as Nitrogen		3733					3.8	<0.06				1.3
Nitrite as Nitrogen		233					0.36	<0.05				0.75
pH Lab (su)						10		7.2		7.7		9.5
Specific Conductance Field (µmhos/cm)						2970						
Specific Conductance Lab (µmho/cm)									3030			
Sulfate						1600	1700	1400	1870	43.2	1540	1900

**Table 1 Water quality analyses for TSF3 and TSF4 reclaim water (Continued)**

Parameter (mg/L unless noted)	Arizona Administrative Code (AAC) R18-11					Blended Reclaim 4/9/1993	TSF4 Reclaim Water 6/4/1999	TSF3 Reclaim Water 7/13/1994	TSF3 Reclaim Water 2/8/2013	Met Test Supernatant 1/12/2015	TSF4 Reclaim Water 3/3/2016	TSF4 Reclaim Water 5/5/2020
	FC <sup>1</sup>	FBC <sup>2</sup>	A&Wc Acute <sup>3</sup>	AgI <sup>4</sup>	AgL <sup>5</sup>							
Matrix						TSF4 Reclaim water	TSF4 Reclaim water	TSF3 Reclaim water	TSF3 Reclaim water	Met Test liquid	TSF4 Reclaim water	TSF4 Reclaim water
Cation & Anion Sum, Total In Water (meq/L)							71.549	66.4392				
Cation Anion Balance (%)							9.1	0.95				
Sum of Anions, Total (meq/L)							39	33.5				
Sum of Cations, Total (meq/L)							32.5	32.9				
Total Dissolved Solids							2900	2500			2590	
Total Petroleum Hydrocarbons									<0.35			
Total Suspended Solids						50					11	
Turbidity Lab (NTU)								72				
Benzene	0.114	0.133	2.7					<0.0005				
Ethylbenzene	2.13	93	23					<0.0005				
Toluene	11.96	149	8.7					0.0033				
Gross Alpha, Total (pCi/L)								<23.7			5±0.5	4.9±0.8
Radium 226, Total (pCi/L)								<0.25				1.4±0.2
Radium 228, Total (pCi/L)								<0.67				1.6±0.3
Laboratory						ATI	DMA	ADOH	SVL	ACZ	SVL Test America	Test America
Laboratory ID						-	PIF00306	-	W3B0198-01	L22554	W6C0094 550-59670-1	550-141734-1

Notes:  
 < values list the laboratory Method Detection Limit (MDL)  
<sup>1</sup> FC = Fish consumption  
<sup>2</sup> FBC = Full-Body Contact  
<sup>3</sup> A&Wc Acute = Aquatic and Wildlife (warm water) Acute toxicity  
<sup>4</sup> AgI = Agricultural Irrigation  
<sup>5</sup> AgL = Agricultural livestock watering  
 Numbers **bold** and underlined exceed reference AAC Surface Water standards  
 Source: Table-1\_Tailings\_Reclaim\_Water 219500-590\_Rev2\_mly

**Table 2 Summary of groundwater quality in APP-1A downgradient of TSF4 (1994-2016)**

Parameter	Units	AQL	AL	# of Samples	Minimum	Maximum	Average
Field pH	S.U.	M	M	37	6.54	7.25	7.02
Field temperature	degrees F	M	M	67	64.58	72.7	68.69
Field specific conductance	µmhos/cm	M	M	76	1204	3200	2308
Lab pH	S.U.	M	M	48	6.84	8	7.31
Lab specific conductance	µmhos/cm	M	M	8	2170	2700	2514
Total dissolved solids	mg/L	M	M	83	1700	2670	2333
Sulfate	mg/L	M	M	75	1000	1560	1366
Chloride	mg/L	M	M	19	65	120	97
Fluoride	mg/L	4.0	3.2	76	<0.1	0.749	<0.4207
Carbonate	mg/L	M	M	20	<1	0	<1.9
Bicarbonate	mg/L	M	M	21	130	184	153
Total Alkalinity	mg/L	M	M	14	140	184	161
Nitrate+nitrite as N	mg/L	10.0	8.0	75	<0.05	3.41	1.43
Calcium	mg/L	M	M	19	310	507	416
Magnesium	mg/L	M	M	20	49	110	90
Potassium	mg/L	M	M	19	6.36	9	8.04
Sodium	mg/L	M	M	19	39.1	500	79.49
Cation/anion balance	%	M	M	17	0.48	58.7	7.678
Aluminium	mg/L	M	M	10	<0.05	<0.5	<0.1981
Antimony <sup>1</sup>	mg/L	0.006	0.0048	22	<0.0008	<0.05	<0.008211
Arsenic	mg/L	0.05	0.04	22	<0.003	0.0053	<0.008483
Barium	mg/L	2	1.6	26	<0.002	0.061	<0.042
Beryllium	mg/L	0.004	0.0032	22	<0.0001	<0.004	<0.000845
Cadmium	mg/L	0.005	0.004	22	<0.0002	0.00043	<0.002625
Chromium (total) <sup>2</sup>	mg/L	0.1	0.08	18	<0.004	4.31	<0.249
Cobalt	mg/L	M	M	12	<0.006	0.05	<0.01951
Copper	mg/L	M	M	79	0.00121	0.42	0.02146
Cyanide (total)	mg/L	M	0.16	19	<0.005	0.005	<0.01658
Iron	mg/L	M	M	78	<0.003	1.82	<0.2009
Lead	mg/L	0.05	0.04	22	<0.0002	0.0074	<0.00385
Manganese	mg/L	M	M	77	<0.004	0.33	<0.113
Mercury	mg/L	0.002	0.0016	21	<0.0002	<0.0002	<0.0002
Nickel <sup>3</sup>	mg/L	0.1	0.08	22	<0.01	1.55	<0.0105
Selenium	mg/L	0.05	0.04	71	0.00032	0.0102	<0.006163
Thallium <sup>4</sup>	mg/L	0.002	0.0016	19	0.0002	0.006	<0.001997
Zinc	mg/L	M	M	78	<0.01	0.478	<0.0424
Gross alpha	pCi/l	M	M	24	-4.8	76	3.67
Adjusted gross alpha	pCi/l	15	12	3	0.78	9.33	5.06
Radium 226 + 228	pCi/l	5	4	10	0.2	1	1.41
Uranium (combined)	µg/l	M	M	11	0.8	5.25	1.56

Source: SRK, 2017. Compiled from water quality data provided by PVMC; AQL and ALs listed in APP No. P-100329; M = Monitor only

1 MDL exceeded the AQL and AL on 6/27/94 and 7/12/95.

2 MDL exceeded AQL and AL on 4/24/2007.

3 MDL exceeded AQL and AL on 4/24/2007.

4 MDS exceeded AQL and AL on 6/27/1994 and 7/12/1995; MDL exceeded AQL on 10/2/2006

**Table 3 Summary of groundwater quality in APP-1B downgradient of TSF4 (1994-2016)**

Parameter	Units	AQL	AL	# of Samples	Minimum	Maximum	Average
Field pH	S.U.	M	M	34	6.79	7.52	7.17
Field temperature	degrees F	M	M	65	66.6	77.7	73.16
Field specific conductance	µmhos/cm	M	M	77	527	1491	1032
Lab pH	S.U.	M	M	49	6.56	8.1	7.32
Lab specific conductance	µmhos/cm	M	M	8	770	1250	1075
Total dissolved solids	mg/L	M	M	90	630	1100	818
Sulfate	mg/L	M	M	84	190	493	316
Chloride	mg/L	M	M	15	47	72	55.257
Fluoride	mg/L	4.0	3.2	76	0.12	<2.5	0.458
Carbonate	mg/L	M	M	15	0.28	<5	1.940
Bicarbonate	mg/L	M	M	13	237	273	260
Total Alkalinity	mg/L	M	M	11	235	273	255
Nitrate-nitrite as N	mg/L	10.0	8.0	71	0.37	2.08	1.267
Calcium	mg/L	M	M	15	83	152	112
Magnesium	mg/L	M	M	17	37	67.1	50.3375
Potassium	mg/L	M	M	15	4.4	5.9	5.01
Sodium	mg/L	M	M	15	53.9	65.2	58.3
Cation/anion balance	%	M	M	14	0.3	11	2.55
Aluminium	mg/L	M	M	10	0.041	<0.50	0.1790
Antimony <sup>1</sup>	mg/L	0.006	0.0048	18	<0.0004	<0.05	<0.0060
Arsenic	mg/L	0.05	0.04	18	0.0047	<0.025	<0.01203
Barium	mg/L	2	1.6	19	0.0301	0.248	0.2067
Beryllium	mg/L	0.004	0.0032	18	<0.0002	<0.004	<0.0013067
Cadmium	mg/L	0.005	0.004	18	<0.0002	<0.005	<0.00188
Chromium (total)	mg/L	0.1	0.08	13	<0.004	0.049	<0.01101
Cobalt	mg/L	M	M	13	<0.005	<0.05	<0.01511
Copper	mg/L	M	M	75	0.0008	0.056	<0.0123
Cyanide (total)	mg/L	M	0.16	15	<0.005	<0.025	<0.0159
Iron	mg/L	M	M	75	<0.02	2.9	<0.6043
Lead	mg/L	0.05	0.04	72	0.0007	<0.05	<0.0186
Manganese	mg/L	M	M	75	<0.0025	0.087	<0.019
Mercury <sup>2</sup>	mg/L	0.002	0.0016	18	<0.0002	<0.01	<0.00204
Nickel	mg/L	0.1	0.08	15	<0.01	<0.05	<0.0327
Selenium <sup>3</sup>	mg/L	0.05	0.04	76	<0.002	<0.06	<0.0051
Thallium <sup>4</sup>	mg/L	0.002	0.0016	15	<0.000075	<0.005	<0.0016
Zinc	mg/L	M	M	75	0.17	2.7	1.3056
Gross alpha	pCi/l	M	M	17	0.85	6.9	4.6100
Adjusted gross alpha	pCi/l	15	12	3	0.64	2.55	1.3967
Radium 226 + 228	pCi/l	5	4	5	0.5	1.7	1.0800
Uranium (combined)	µg/l	M	M	7	1.81	10.2	5.0057

Source: SRK, 2017. Compiled from water quality data provided by PVMC; AQL and ALs listed in APP No. P-100329; M = Monitor only

- 1 MDL exceeded the AQL and AL on 6/27/94 and 7/12/95.
- 2 MDL exceeded the AQL and AL on 11/16/93, 2/15/14, 7/12/14
- 3 MDL exceeded the AQL and AL on 10/26/99.
- 4 MDL exceeded the AQL and AL on 7/12/95.

**Table 4 Summary of groundwater quality in APP-2 downgradient of TSF4 (1994-2016)**

Parameter	Units	AQL	AL	# of samples	MIN	MAX	AVERAGE
Field pH	S.U.	M	M	35	5.98	6.54	6.35
Field temperature	degrees F	M	M	69	55.8	74.1	69.56
Field specific conductance	µmhos/cm	M	M	81	802	2500	1497
Lab pH	S.U.	M	M	54	5.97	8.09	6.52
Lab specific conductance	µmhos/cm	M	M	9	1340	1710	1522
Total dissolved solids	mg/L	M	M	84	1150	2000	1388
Sulfate	mg/L	M	M	76	480	1300	793
Chloride	mg/L	M	M	19	42.8	77	54.61
Fluoride	mg/L	4.0	3.2	84	0.06	1.5	0.24
Carbonate	mg/L	M	M	18	<1	<5	<2
Bicarbonate	mg/L	M	M	16	61	92	82.01
Total Alkalinity	mg/L	M	M	11	62	91.1	84.62
Nitrate+nitrite as N	mg/L	10.0	8.0	80	0.85	4.9	1.69
Calcium	mg/L	M	M	19	226	364	287.74
Magnesium	mg/L	M	M	19	32.8	59	45.13
Potassium	mg/L	M	M	19	5.1	7.1	5.86
Sodium	mg/L	M	M	19	42.9	67	54.45
Cation/anion balance	%	M	M	18	0.01	6.6	2.31
Aluminium	mg/L	M	M	11	<0.03	<0.5	<0.1846
Antimony <sup>1</sup>	mg/L	0.006	0.0048	28	<0.0004	<0.05	<0.0069
Arsenic	mg/L	0.05	0.04	28	<0.0027	<0.025	0.011
Barium	mg/L	2	1.6	23	0.0283	0.05	0.0424
Beryllium <sup>2</sup>	mg/L	0.004	0.0032	28	0.0002	<0.004	<0.0012
Cadmium <sup>3</sup>	mg/L	0.005	0.004	28	<0.001	<0.005	<0.0017
Chromium (total)	mg/L	0.1	0.08	16	<0.004	<0.01	<0.0069
Cobalt	mg/L	M	M	20	0.00059	<0.05	<0.0131
Copper	mg/L	M	M	83	0.00109	<0.1	<0.0130
Cyanide (total)	mg/L	M	0.16	19	<0.005	<0.025	<0.0166
Iron	mg/L	M	M	83	0.01	<0.5	<0.1223
Lead	mg/L	0.05	0.04	28	<0.0001	<0.005	<0.0031
Manganese	mg/L	M	M	84	<0.0040	<0.05	<0.0183
Mercury	mg/L	0.002	0.0016	19	<0.00020	0.00044	<0.00020
Nickel	mg/L	0.1	0.08	28	<0.0016	<0.05	<0.0265
Selenium <sup>4</sup>	mg/L	0.05	0.04	83	0.0003	<0.06	<0.0040
Thallium <sup>5</sup>	mg/L	0.002	0.0016	19	<0.000075	<0.005	<0.0017
Zinc	mg/L	M	M	83	<0.01	0.9	<0.0437
Gross alpha	pCi/l	M	M	21	<0.8	9.3	<4.41
Adjusted gross alpha	pCi/l	15	12	5	1.6	9.3	3.96
Radium 226 + 228	pCi/l	5	4	10	0.1	2	0.64
Uranium (combined)	µg/l	M	M	12	0.480	<2.4	1.400

Source: Compiled by SRK from water quality data provided by PVMC; AQL and ALs listed in APP No. P-100329; M = Monitor only

- 1 MDL exceeded the AQL and AL on 6/23/94 & 7/11/95.
- 2 MDL exceeded the AQL and AL on 6/23/94 & 7/11/95.
- 3 MDL exceeded the AL on 11/13/96, 2/11/97, 5/1/97, 7/10/97, 10/9/97, 1/26/98, 4/22/98, 7/28/98.

# Figures



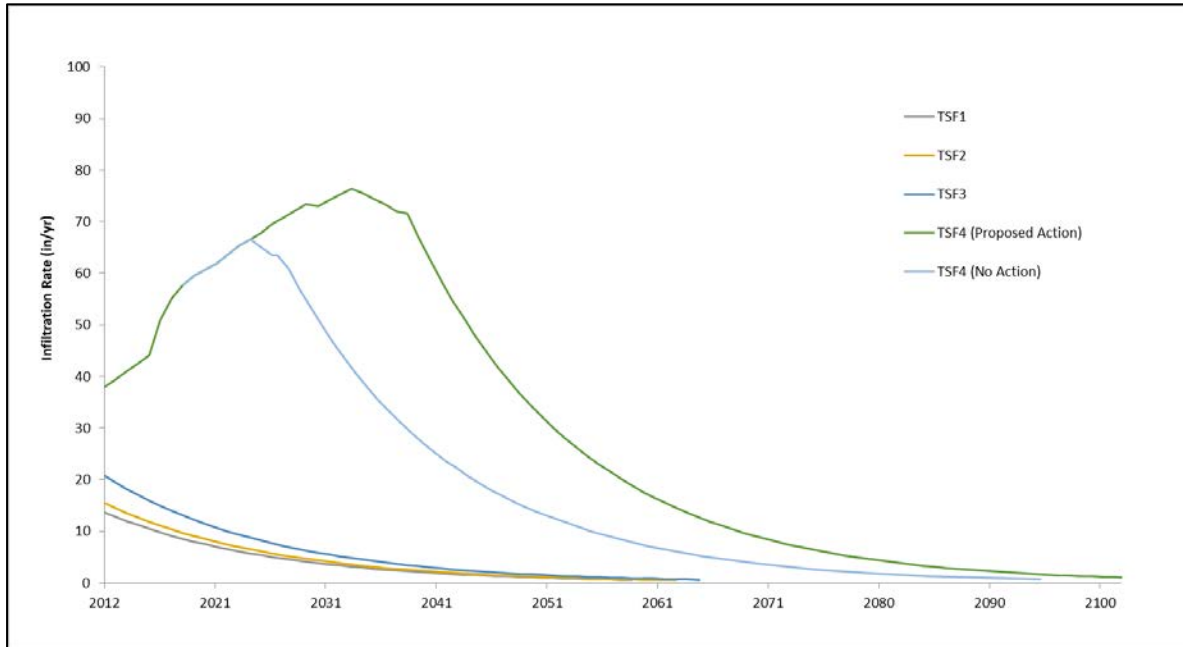

Source: Modified from SRK, 2019

**Figure 1 Simulated variable in time – Recharge rates from precipitation and TSFs**

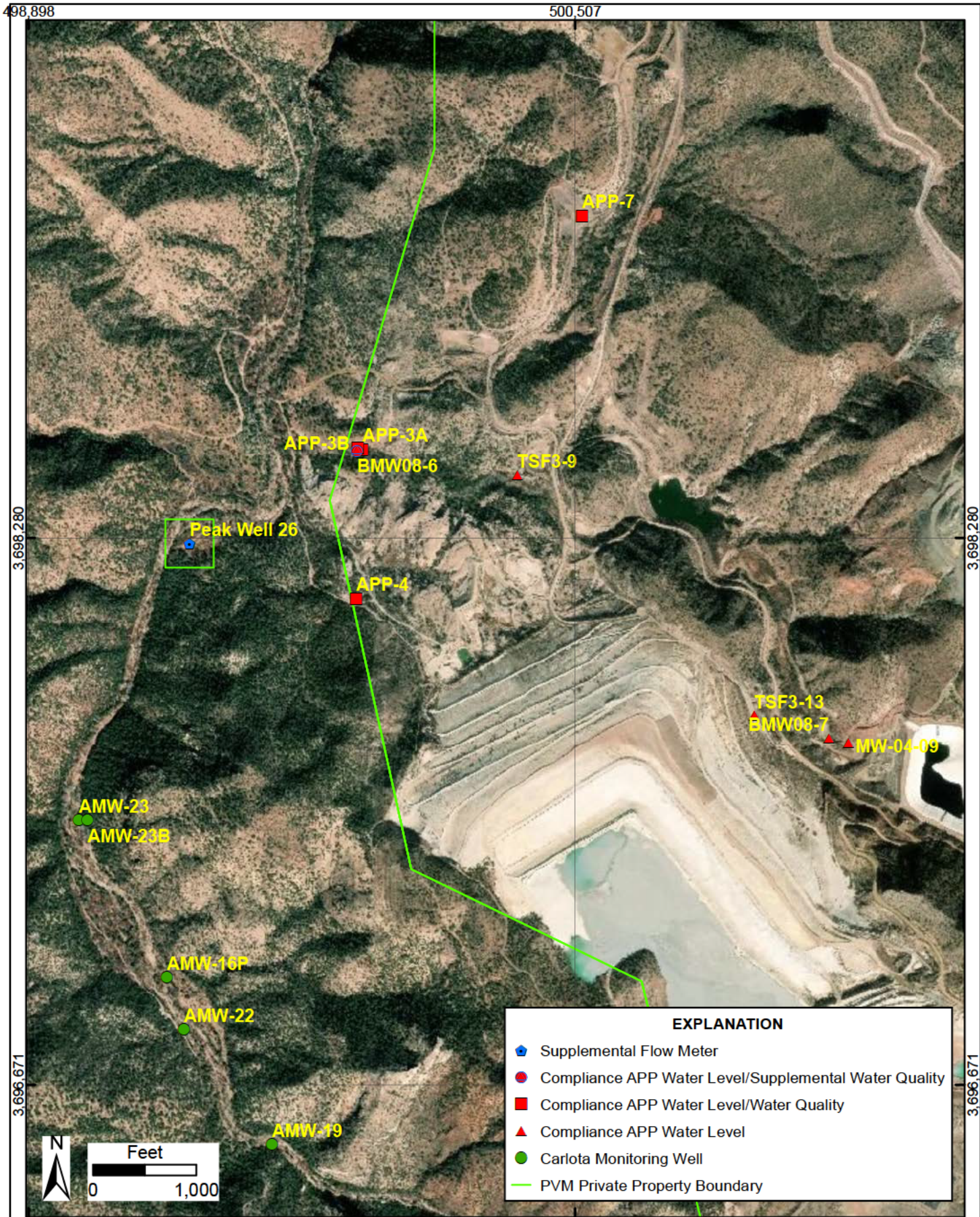

EXPLANATION	
	Supplemental Flow Meter
	Compliance APP Water Level/Supplemental Water Quality
	Compliance APP Water Level/Water Quality
	Compliance APP Water Level
	Carlota Monitoring Well
	PVM Private Property Boundary

DRAWING TITLE:		TAILINGS SEEPAGE MANAGEMENT PLAN
ISSUED FOR:		PINTO VALLEY MINING CORP
DRAWING NO.	FIGURE 2	REVISION NO.
SRK JOB NO.	219500.590	<b>A</b>

NAD 1983 UTM Zone 12N		
DESIGN:	DRAWN:	REVIEWED: VS
SCALE:	1 inch = 1,250 feet	
FILE:	DATE: 6/9/2020	
MonitoringWells_Figure_Rev02_TSF3.mxd		

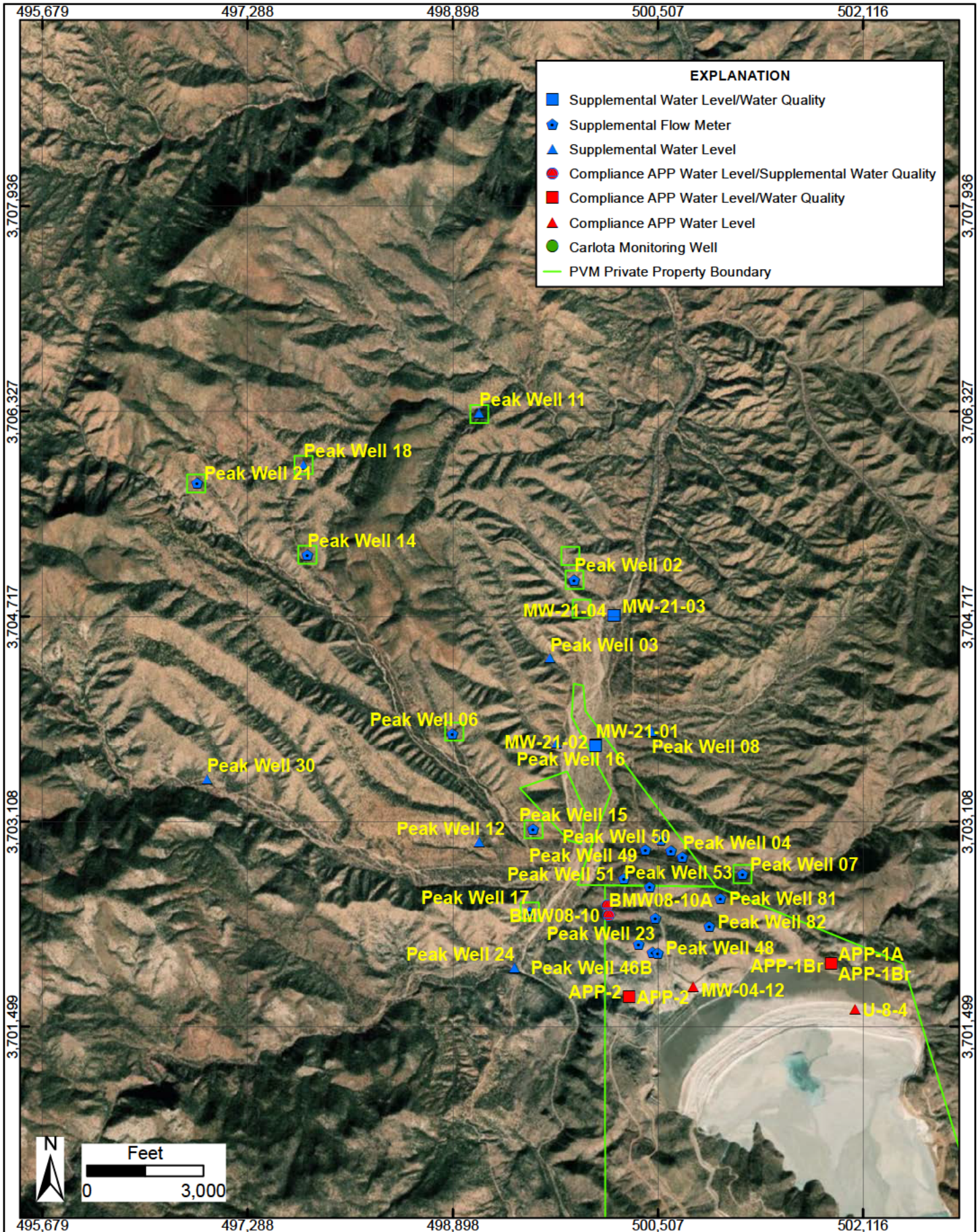

EXPLANATION	
■	Supplemental Water Level/Water Quality
⬠	Supplemental Flow Meter
▲	Supplemental Water Level
●	Compliance APP Water Level/Supplemental Water Quality
■	Compliance APP Water Level/Water Quality
▲	Compliance APP Water Level
●	Carlota Monitoring Well
—	PVM Private Property Boundary

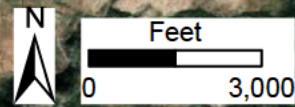

NAD 1983 UTM Zone 12N		
DESIGN:	DRAWN:	REVIEWED: VS
SCALE: 1 inch = 3,333 feet	DATE: 6/9/2020	
FILE: MonitoringWells_Figure_Rev02_TSF4.mxd		

### WATER SUPPLY AND MONITORING WELLS NEAR TSF4

DRAWING TITLE: TAILINGS SEEPAGE MANAGEMENT PLAN	
ISSUED FOR: PINTO VALLEY MINING CORP	
DRAWING NO. FIGURE 3	REVISION NO. A
SRK JOB NO. 219500.590	

PATH: P:\Capstone\_Mining\050\_GIS\Tailings Seepage\MonitoringWells\_Figure\_Rev02\_TSF4.mxd Source: Esri, DigitalGlobe, GeoEye, Earthstar Geographics, CNES/Airbus DS, USDA, USGS, AeroGRID, IGN, and the GIS User Community

