

UNCLASSIFIED//~~FOR OFFICIAL USE ONLY~~



Defense Intelligence Reference Document

Defense Futures

01 November 2010

ICOD: 20 July 2010

DIA-08-1011-004

Aneutronic Fusion Propulsion

UNCLASSIFIED//~~FOR OFFICIAL USE ONLY~~

(U) Aneutronic Fusion Propulsion

The **Defense Intelligence Reference Document** provides nonsubstantive but authoritative reference information related to intelligence topics or methodologies.

Prepared by:

(b)(3):10 USC 424

Defense Intelligence Agency

Authors:

(b)(6)

COPYRIGHT WARNING: Further dissemination of the photographs in this publication is not authorized.

This product is one of a series of advanced technology reports produced in FY 2010 under the Defense Intelligence Agency, (b)(3):10 USC 424 Advanced Aerospace Weapons System Applications (AAWSA) Program. Comments or questions pertaining to this document should be addressed to

(b)(3):10 USC 424;(b)(6) AAWSA Program Manager, Defense Intelligence Agency, ATTN: (b)(3):10 USC 424

(b)(3):10 USC 424 Bldg 6000, Washington D.C. 20340-5100.

Contents

Chapter 1: Concept Overview	1
Chapter 2: Fusion Plasma Physics	3
2.1 Magnetic Confinement.....	5
2.2 Inertial Confinement	7
2.3 Electrostatic Confinement	8
2.4 Magneto-Inertial Confinement	9
Chapter 3: Fusion Propulsion	11
3.1 Fusion Reactors for Propulsion.....	11
3.2 Air Propulsion	13
3.3 Ion Propulsion	14
3.4 Plasma Thruster	14
Chapter 4: Applications	17
4.1 Near Space	17
4.2 Earth Orbit	17
4.3 Interplanetary.....	18
4.4 Interstellar.....	19
Chapter 5: Recent Developments	21
5.1 U.S. DOE Programs.....	21
5.2 International Programs.....	21
5.3 NASA Programs.....	23
5.4 Privately Funded Programs	23
Chapter 6: Future Developments.....	25
6.1 Near-Term Developments	25
6.2 Mid-Term Developments	27
6.3 Far-Term Development.....	28
Chapter 7: Conclusions.....	30

Chapter 8: Endnotes 31

Figures

Figure 1. Fusion Reaction Cross Sections vs. Temperature..... 4
Figure 2. Magnetic Mirror Confinement 6
Figure 3. a) Tokamak and b) Stellarator Confinement..... 6
Figure 4. Field-Reversed Configuration 7
Figure 5. IEC Fusor and Polywell Confinement Configurations 8
Figure 6. Magnetized Target Fusion Experiment at LANL..... 10
Figure 7. Dense Plasma Focus (Lawrenceville Plasma Physics)..... 10
Figure 8. Specific Power as a Function of Plasma Temperature of Fusion Rocket. 11
Figure 9. Colliding Beam Fusion Reactor 12
Figure 10. DPF Thruster System With Direct Conversion 12
Figure 11. Magnetized Target Fusion Reactor 13
Figure 12. MHD Air-Breathing and Fusion Rocket Aerospace Plane 13
Figure 13. Design of an IEC Jet Thruster - Experimental Device..... 18
Figure 14. Comparison of Fusion, Nuclear-Thermal, and Chemical Propulsion for Same Payload..... 19
Figure 15. Thrust-to-Weight Ratio and Exhaust Velocity Regimes for Various Long-Range Space Propulsion Options. 19
Figure 16. Bussard Ram Jet..... 20
Figure 17. Progress in Tokamak Magnetic Confinement Fusion..... 22
Figure 18. ITER Design Concept With BWR Size and Blanket Segment..... 23
Figure 19. Experiments To Prove a Plasma Fusion Propulsion Concept 28
Figure 20. Roadmap to Aneutronic Fusion Propulsion Development..... 29

Tables

Table 1: Principal Fusion Reactions.....3
Table 2: Fusion Peak Interaction Temperatures and Fusion Energy to X-rays.....4
Table 3: Fusion Ignition Temperatures.....5
Table 4: Advanced Fusion Concept Reactor Companies.....24
Table 5: Emerging Technologies.....26

Aneutronic Fusion Propulsion

Summary

Controlled fusion energy production has been under development for 60 years. The primary objective has been gaining the ability to create terrestrial power plants using deuterium and tritium as fuel. Unfortunately, this objective has been eluded for both technical and economic reasons. However, the threshold for achieving success in applying fusion to propulsion is considerably relaxed, especially if fuels are used that do not use tritium. Tritium has to be continuously bred; these reactions yield fast neutrons, which require shielding and cause structural materials to be periodically replaced. Such "aneutronic" fusion fuels, such as hydrogen fusing with Boron-11, have been studied extensively for space propulsion applications since the 1980s.

This report reviews the basic fusion plasma physics, design concepts that apply aneutronic fusion for propulsion, and the requirements for transitioning to space. The predominant concepts studied include magnetic field reversed configuration, dense plasma focus and inertial electrostatic confinement. All of these concepts have venture capital funded programs for terrestrial fusion power. When applied to space or near-space propulsion, they can exceed the performance of any conventional electric thruster.

The future technology development of aneutronic fusion propulsion will initially be motivated by the very large GEO satellites that will be developed in the next 20 years for commercial and military broadband communication. Further development of very-high-power propulsion systems (> 100 kW) to Mars and beyond will require major developments in all technology areas for confinement pulsed power and ion fuel beam accelerators.

Chapter 1: Concept Overview

Controlled thermonuclear fusion has been the aspiration for nuclear scientists and engineers for the last 60 years. During that time, tens of billions of dollars have been invested in this endeavor with the expected fruition being pushed even further into the future. When Lyman Spitzer invented the Stellarator in 1951, it was expected to take only 5 years of concentrated plasma physics experiments to harness the fusion of hydrogen ions confined by magnetic fields. However, the numerous new instabilities that arose under increasing higher magnetic confinement pressures have been a roadblock to the success of controlled fusion.

In 1983, a rediscovery was made by Robert Bussard of a fusion device invented by Robert Hirsch in his 1966 Ph.D. thesis. The Fusor, as Hirsch named it with his thesis advisor and famous inventor Philo Farnsworth, simply used spherically concentric electrodes in a vacuum chamber. When a deuterium gas was supplied to the chamber and a few-microsecond pulse at 30 kV was applied to the electrodes, D-D fusion occurred, releasing He and neutrons. Although it released less energy than was needed to supply the initial electric pulse, it provided the evidence for a method to obtain supplementary heating to ignition of magnetically confined plasmas.

The Fusor led to continued development of what is now called Inertial Electrostatic Confinement (IEC) devices. Amongst these was the Dense Plasma Focus (DPF), a plasma production tube invented in 1961, and several other devices. Magnetic confinement devices utilized the IEC method with imploding layers of lithium or applying intense beams from either end of a linear magnetic pinch device. This resurgence of alternate confinement concepts was immediately applied to fusion space propulsion since it was recognized that there would be an advantage over nuclear fission propulsion with its costly safety requirements. For mitigating shielding mass and tritium fuel launch-safety concerns, non-neutron-generating "aneutronic" fusion fuels were also adopted.

Aneutronic fusion fuels include those isotopes of light elements that when fused produce no neutrons or a very few from the fusion of daughter products. Although there are eight such reactions for light nuclei, the most practical for fusion reactors include the following:

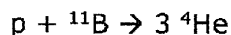
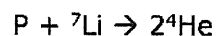
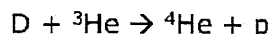

In Chapter 2, we will review the fusion plasma physics needed to apply these aneutronic reactions to a confinement device to make a fusion reactor practicable for propulsion, which is described in Chapter 3. In Chapter 4, the relevance of these aneutronic fusion propulsion concepts will be reviewed and assessed for aerospace applications including near-space, orbital, and interplanetary propulsion, as well as the potential for interstellar use. In Chapter 5, we will summarize the recent national, international, and privately funded R&D that may expedite development, while in Chapter 6, we outline an R&D path forward for the aneutronic fusion technologies and systems needed for the next 50 years. Finally, we provide a summary in Chapter 7 that conveys aneutronic fusion propulsion:

- May have near-term applications to replace current satellite ion thrusters and extend application to interplanetary flight.
- Requires extensive technology development for air and near-space applications.
- Will not be practical beyond the solar system unless breakthrough propulsion physics can assist the flight to the next stellar system, where fusion "ion thrusters" can then be used.

Despite the attention propulsion has gotten from the scientific community, the problem has been insufficiently addressed by the space science community. Although it is certainly true that the fusion drive train must be successful from a theoretical and experimental perspective before consideration for adaptation to the space environment, many critical aspects such as Earth-based launch, space-based assembly, space materials science, safe flight operations, and mission success need to be introduced early in the design phase. More importantly, now that these fusion propulsion concepts are starting to look both feasible and attractive, the transition to space and the inherent aerospace application development need considerable focus.

Toward this consideration, we now begin with a background on plasma physics that includes fusion efficiencies and confinement schemes for aneutronic fusion, which leads us to the application to the propulsion concept discussions that follow.

Chapter 2: Fusion Plasma Physics

At the most basic level, nuclear fusion occurs by forcing atomic nuclei close enough so that the attractive strong force (which binds nuclei together) overwhelms the very powerful electromagnetic repulsion force. Under such circumstances the nuclei fuse together to form a single nucleus, creating an atom of a different element (along with byproducts such as radiation and neutrons). Because the strong force dominates over such short-length scales ($\sim 10^{-15}$ meter, the diameter of a medium-sized nucleus), the fusion of heavier nuclei are inherently more unstable, with smaller binding energies. For light nuclei, the binding energies of the individual nuclei are significantly smaller than that of the fused nucleus; it is the released energy of the fusion process (in the form of high-energy photons or kinetic energy of nuclear products such as neutrons) that is sought as an energy source. Table 1 shows Fusion reactions including the relevant aneutronic fusion reactions.

Table 1: Principal Fusion Reactions

	<u>E (MeV)</u>
<i>Main controlled fusion fuels</i>	
$D + T \rightarrow \alpha + n$	17.59
$D + D \rightarrow \begin{cases} T + p \\ {}^3\text{He} + n \\ \alpha + \gamma \end{cases}$	4.04 3.27 23.85
$T + T \rightarrow \alpha + 2n$	11.33
<i>Advanced fusion fuels</i>	
$D + {}^3\text{He} \rightarrow \alpha + p$	18.35
$p + {}^6\text{Li} \rightarrow \alpha + {}^3\text{He}$	4.02
$p + {}^7\text{Li} \rightarrow 2\alpha$	17.35
$p + {}^{11}\text{B} \rightarrow 3\alpha$	8.68

To fuse a sufficient number of nuclei within a span of time for practical use, it is generally necessary to heat an ensemble of atoms to the very high energies shown in Table 1. These energies (temperatures) are high enough that electrons are stripped from their associated nuclei, producing a plasma of free electrons and ions. The fusion reaction cross sections (σ), the probability of interaction for these reactions in barns = 10^{-28} m^2 , is shown in Figure 1. For the maximum reaction rate temperature, the ratio of the total amount of energy (kinetic plus radiation) released in the fusion reaction relative to the bremsstrahlung radiation released is shown in Table 2.

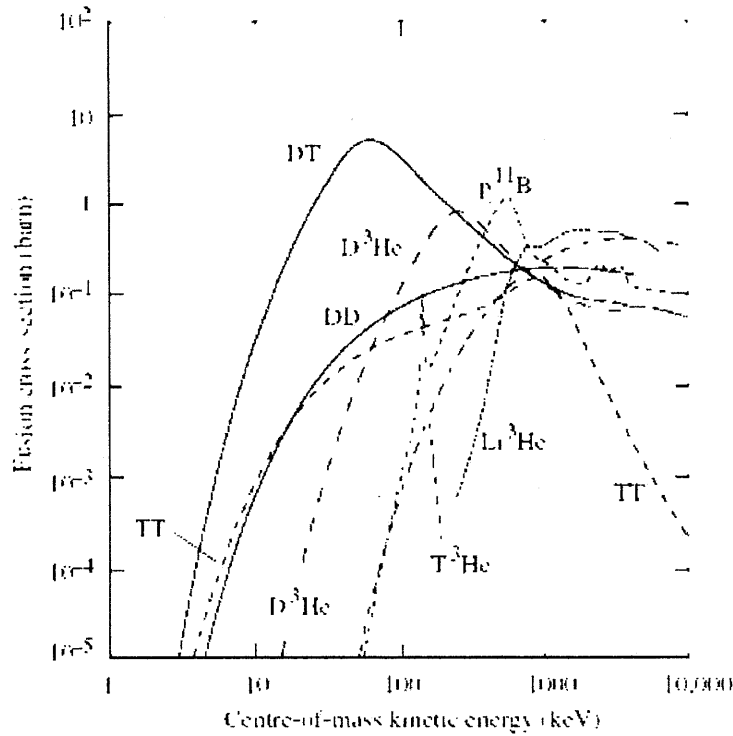

Figure 1. Fusion Reaction Cross Sections vs. Temperature

Table 2: Fusion Peak Interaction Temperatures and Fusion Energy to X-rays

fuel	T_j (keV)	$P_{\text{fusion}}/P_{\text{Bremsstrahlung}}$
${}^2\text{D}-{}^3\text{T}$	50	140
${}^2\text{D}-{}^2\text{D}$	500	2.9
${}^2\text{D}-{}^3\text{He}$	100	5.3
${}^3\text{He}-{}^3\text{He}$	1000	0.72
$\text{p}-{}^6\text{Li}$	800	0.21
$\text{p}-{}^{11}\text{B}$	300	0.57

If the ratio is low, it takes more confining energy to sustain the reaction. The largest fusion output is obtained when the temperature is chosen so that $\langle\sigma v\rangle/T^2$ is a maximum (known as the Lawson Criteria), which for plasma ignition is achieved when the fusion reactions produce enough power to maintain the temperature without external heating. This is shown in Table 3 for the most relevant neutronic and aneutronic fusion fuels. While the ignition temperature is up to a factor of 10 higher for the aneutronic fusion reactions, the confinement power required for ignition will be one to two orders of magnitude greater. This will therefore require some unique confinement concepts to achieve ignition.

In order to facilitate efficient fusion, it is also necessary to constrain the motions of the charged particles (i.e., confine the plasma) in an attempt to maximize the likelihood of ion collisions. Therefore, the net energy produced by the fusion process is more realistically the released energy minus the energy consumed for plasma heating and confinement. The fusion energy gain factor, usually expressed with the symbol Q , is the ratio of fusion power produced in a nuclear fusion reactor to the power required to maintain the plasma temperature; for the Lawson Criterion, breakeven $Q = 1$. However, to provide sufficient energy to convert that power to a useful level, a minimum $Q > 5$ is needed, and for a power plant to generate electricity the Q should be > 30 .

For the fusion reactions shown in Table 3, the $(D, {}^3\text{He})$ will produce a few fusion neutrons which can be minimized by running hot and deuterium-lean; however, the application may be limited by the availability of ${}^3\text{He}$. Other reactions to consider will be the $(p, {}^6\text{Li})$ and $(p, {}^{11}\text{B})$. First, a review the most commonly used plasma confinement methods is needed.

Table 3: Fusion Ignition Temperatures

fuel	T [keV]	$\langle \sigma v \rangle T^2$ [$\text{m}^3 \text{s}^{-1} \text{keV}^{-2}$]
${}^2\text{D}-{}^2\text{H}$	13.6	$1.24 \cdot 10^{-24}$
${}^2\text{D}-{}^3\text{D}$	15	$1.38 \cdot 10^{-26}$
${}^2\text{D}-{}^3\text{He}$	58	$2.24 \cdot 10^{-26}$
$p-{}^6\text{Li}$	66	$1.46 \cdot 10^{-27}$
$p-{}^{11}\text{B}$	123	$3.01 \cdot 10^{-27}$

MAGNETIC CONFINEMENT

Magnetic confinement is an often-used method for constraining the motion of the plasma "fuel," increasing the efficiency of nuclear collisions and the fusion process. The plasma is composed of charged particles and is, therefore, affected by electric and magnetic fields. Charged particles spiral along magnetic field lines with electrons spiraling faster and in smaller radii and in opposite directions than their heavier ion counterparts. As the magnetic field increases at the ends of a magnetic mirror, the charged particles will reverse direction along the field lines and thus become trapped. A chamber can be designed such that an appropriate magnetic field configuration can be produced that guides and constrains the motion of the plasma (see Figure 2). The pressures (thermal, kinetic, magnetic) of the plasma "gas" are balanced by the high pressure of the imposed magnetic field—the plasma is "contained" by the magnetic field. One obvious advantage of this approach is that the imposed magnetic field prevents (or at least delays) much of the plasma (at energies of tens of keV or temperatures of several hundred millions of degrees Kelvin) from coming into contact with the structural elements of the chamber. The pressures are typically on the order of one bar, and depending on the design, confinement times can span a few seconds to minutes. Although magnetic confinement designs are in principle steady-state systems, their primary difficulty is maintaining the strong damping of the various modes of plasma instabilities that arise in these systems.

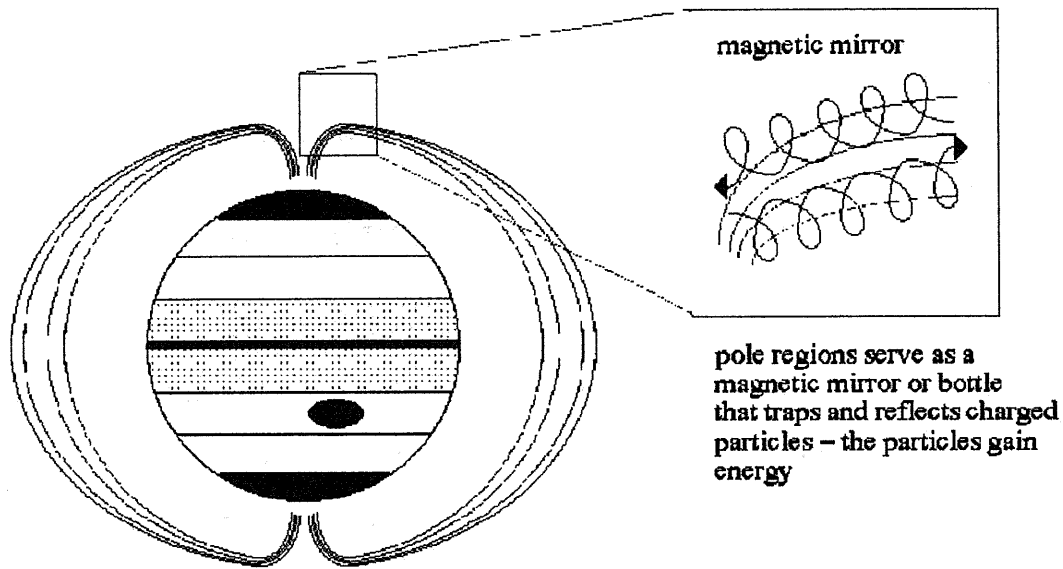

Figure 2. Illustration of Magnetic Mirror Confinement in Vicinity of Jupiter

A second, related magnetic method is to join the ends of the solenoid together as a toroid, confining the plasma to a ring. A simple toroidal (i.e., circular) field, however, provides poor confinement because the radial gradient of the magnetic field strength results in plasma drift. A method to reduce drift and produce a stable plasma equilibrium is to superpose a poloidal magnetic field with the toroidal field, thus driving a current through the plasma itself. This provides a path for the plasma moving along the outer edge of the toroid to migrate to the inner edge and vice versa. This is the method used in tokamak systems (shown in Figure 3). Another solution has been to structurally modify the toroid chamber into a figure-eight configuration. This allowed plasma to spend half of the time on the inner portion of the tube, and half of the time on the outer portion of the tube. Such systems are called stellarators. This configuration has eventually evolved back into a (non-axially symmetric) toroidal configuration; rotating the windings in such a manner produces a stable plasma equilibrium while eliminating the need for a toroidal magnetic field. The fundamental issue with these confinement systems is that they require superconducting magnetic coils, pressure vessels, and neutron-energy-absorbing blankets for a 6-meter major radius by 6-meter high plasma, an enormous technological undertaking—and that is just for an ignition demonstration (see Chapter 5).

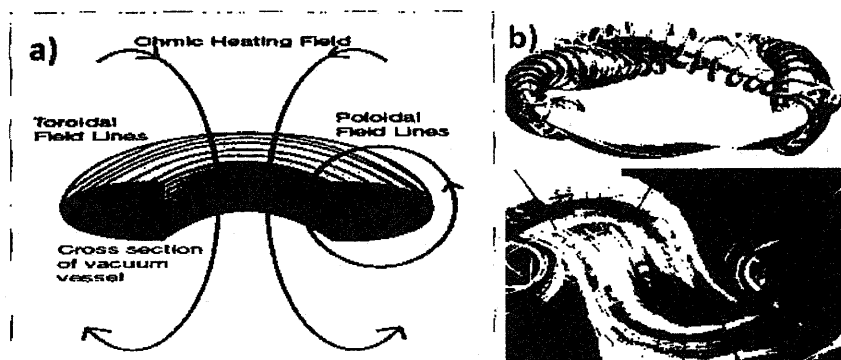

Figure 3. a) Tokamak and b) Stellarator Confinement

A spheromak is a tokamak in a spherical chamber that uses only a single set of coils in conjunction with plasma currents that self-generate a confining magnetic field. However, this design is thought to be less promising than the previously described technologies for generating significant fusion energy.

An FRC (field-reversed configuration) is an elongated plasma ellipsoid conducting an azimuthal current that reverses the direction of an

externally applied magnetic field. The resultant field provides toroidal plasma confinement without requiring a toroidal vacuum vessel or coil set (shown in Figure 4). It has the potential of achieving much higher stable plasma configurations in much smaller volumes than a tokamak using supplementary laser or neutral beam heating from its ends. The FRC is susceptible, however, to a tilting mode instability where the confined plasma ring can flip over and fly apart as the previously confining forces shift radially outward rather than inward. This can be overcome by magnetic field design. A significant augmentation of power density for this concept is to inject the fuel through the ends with high energy ion or neutral particle beams. Such a system can allow the very high plasma energy density, temperatures, and confinement times needed for aneutronic fusion.

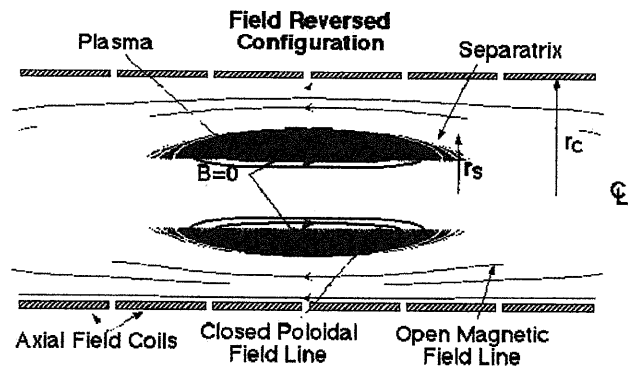

Figure 4. Field-Reversed Configuration

INERTIAL CONFINEMENT

Inertial confinement fusion (ICF) is a process by which nuclear fusion is initiated by heating and compressing a fuel target. Such targets are usually pellets containing a "fuel" of deuterium and tritium atoms. Typical pellets are about the size of a pinhead, holding ~10 mg of fuel. The process of compressing and heating the pellet is usually accomplished by one of two methods: using high-energy lasers or using particle beams (electrons or ions). The vast majority of ICF devices use lasers.

The lasers heat the pellet's outer layer, which explodes this layer outward and produces a reaction force against the remainder of the target. The lasers either impact the pellet simultaneously from multiple symmetrically arranged directions or illuminate the inner wall of a metal cylinder (a hohlraum) containing the pellet (the hohlraum then produces thermal x-rays which impact the pellet). This force accelerates the fuel inward, sending shock waves into the pellet's center. If the shock waves are strong enough, they are able to compress and heat the fuel at the center to such an extent that fusion can occur. The released energy then heats the surrounding fuel, which may also undergo fusion. In comparison with magnetic confinement, ICF results in much higher pressures, but at the expense of a much shorter confinement time.

The goal of ICF is to get a sufficient percentage of the fuel to undergo fusion such that more energy is released than is used to produce the reaction. Early attempts, however, have demonstrated that ICF efficiency was much lower than expected. Recent advances in materials technology and techniques have shown that considerable improvements in performance are possible; such a test at the DOE National Ignition Test Facility (NIF) will use 50 TW of laser energy in 192 beams to compress a pellet to achieve ignition.

The perennial challenge for developing such a device into a power reactor is the feat of manufacturing and compressing 10 such 1-mm DT fuel pellets per second. One significant problem is maintaining equal pressure on the pellets repeatedly to permit energy production.

ELECTROSTATIC CONFINEMENT

This simple method of confinement is composed of concentric spheres (or sometimes cylinders) acting as anode and cathode in a vacuum known as a Farnsworth-Hirsch Fusor or, more commonly, Inertial Electrostatic Confinement (IEC). As shown in Figure 5, the inner sphere (cathode) is not solid, but rather is composed of a wire grid. Ions entering the vacuum chamber between the anode and cathode are accelerated through a large potential difference toward the cathode. Passing through the cathode, the ions collide in the central region, with a small portion of the plasma population undergoing fusion.^{1, 2, 3} However, using this simple setup, it has been argued that net energy production is not viable for anything other than deuterium-tritium fusion, in part because the fusion-collision cross section is several orders of magnitude smaller than the Coulomb-collision cross section.⁴ An additional difficulty is that some of the plasma interacts directly with the cathode, contaminating the plasma with heavy sputtered ions. A method for mitigating this problem is to eliminate the cathode grid and instead use magnetic (and electrostatic) fields to create a virtual cathode composed of electrons. Such devices include the Polywell⁵ and the Penning trap.⁶ One such Penning trap design developed at Los Alamos injects electrons into the central region in such a manner as to produce a harmonic oscillator potential. Called a Periodically Oscillating Plasma Sphere (POPS), ions in this chamber then also undergo harmonic oscillations and can become phase-locked with the use of an externally applied radiofrequency electric field.^{7, 8} This allows the ions to reach very high densities and temperatures as they collide at the center of the chamber. This promising design eliminates any power loss due to Coulomb collisions and substantially increases the efficiency of fusion-power generation.

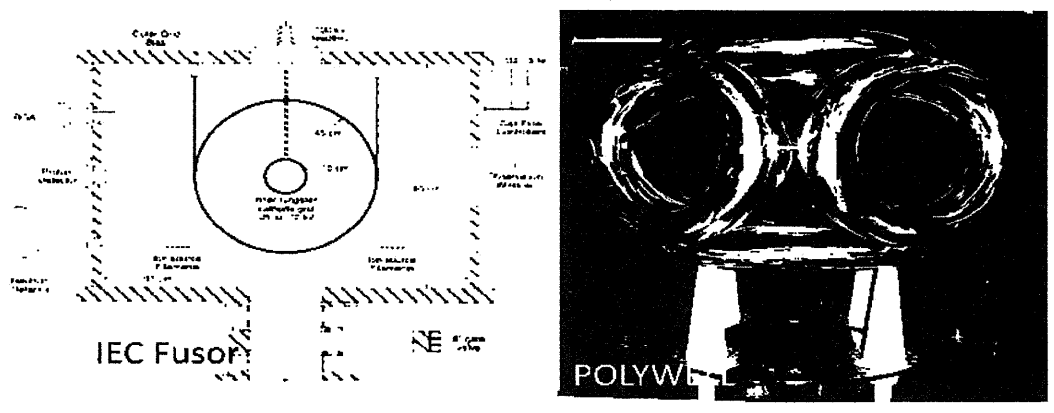

Figure 5. IEC Fusor and Polywell Confinement Configurations

MAGNETO-INERTIAL CONFINEMENT

This method of confinement is an adaptation of the inertial confinement system (ICF) described above, but also uses some of the methods developed for magnetic confinement in an attempt to lower the fusion ignition requirements for implosion velocity and power density.⁹ This concept uses a strong magnetic field within a conducting shell (a magnetic flux conserver). The inertial fusion target plasma lies within the conducting shell. As the shell is imploded, the magnetic intensity increases dramatically, constraining and heating the plasma and facilitating fusion. This concept is being pursued in the United States by the Office of Fusion Energy Sciences of the Department of Energy. Currently there are two classes: High-gain magneto-inertial fusion (MIF) and low-to-intermediate-gain magneto-inertial fusion.

High-Gain MIF

The heating power directed into a hot spot for fusion ignition must be greater than the rate of heat energy loss, and this implies that a high implosion velocity is needed for high-yield fusion. However, a higher implosion velocity actually lowers the efficiency of fusion, since less of the cold fuel is assembled (the higher velocity increases the breakdown of density barriers or growth rate of the Rayleigh-Taylor instability). As described above, lasers are typically used for direct implosion of the fuel pellet but, to date, this is not very efficient and the cost per unit energy is high. With a magnetized target, however, the implosion velocity need not be so high to initiate fusion ignition, thus lowering the input energy cost without sacrificing efficiency.

Low-to-Intermediate MIF

For low-yield fusion, electromagnetic pulsed power can be substituted for lasers or particle beams to compress the target. A lower implosion velocity implies that a larger shell can be used, leading to longer burn duration and a much lower density target. It is thought that by using an imposed magnetic field, a solid or liquid shell (liner) and a gaseous target can be used, rather than the usual cryogenic solid fuel pellets. Such is the case for the Magnetized Target Fusion experiment being performed at LANL (shown in Figure 6).

A similar pulsed compression of a fusion fuel gas can be achieved without a target by instead using Dense Plasma Focus (DPF) having annular electrodes (shown in Figure 7). In this case a capacitor bank is discharged into the electrodes driving a nanosecond to microsecond pulse that will heat the plasma created to ignition temperatures. This by far is the simplest and least elaborate magnetic confinement concept to achieve aneutronic fusion ignition.

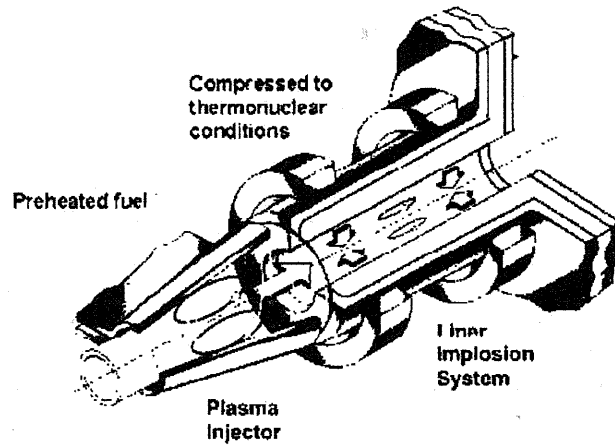

Figure 6. Magnetized Target Fusion Experiment at LANL

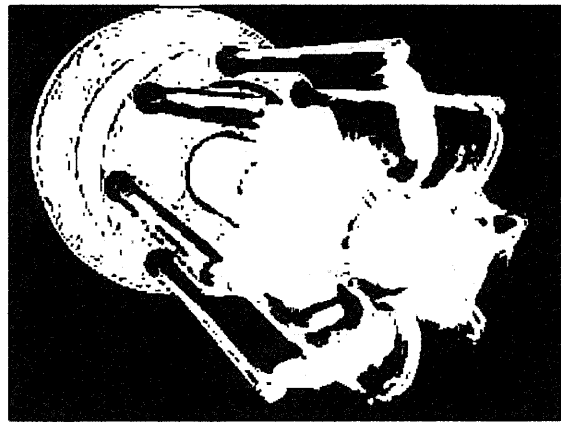

Figure 7. Dense Plasma Focus (Lawrenceville Plasma Physics)

Chapter 3: Fusion Propulsion

FUSION REACTORS FOR PROPULSION

Controlled nuclear fusion reactors have been seriously studied since the late 1960s after tokomaks demonstrated a very promising improvement in temperature and confinement time that had potential to become power-producing reactors. After 15 years, such studies predicted that the size and complexity of a DT (deuterium tritium)-fueled Tokomak would be prohibitively too large to be considered for aerospace applications. However, in the early 1990s when it became clear from large tokomak experimental results that controlled fusion for terrestrial power generation would require an indeterminate time to develop, a surge of interest in fusion-powered propulsion grew. All such studies abandoned the use of DT fusion fuels because of the need for heavy shielding for the 14-MeV neutrons and the requirement for launch safety and the additional complexity of breeding tritium. Only (D,³He) (deuterium helium-3) and (p,¹¹B) (hydrogen boron) fuels have been considered because of the higher specific powers achievable for air and space flight.

Field-Reversed Configuration Reactors

(U) The seminal study on fusion propulsion that developed specific design parameters was performed in 1993.¹⁰ It reviewed previous studies and used a generic cylindrical fusion plasma model for analyzing the specific power for such a system using (D,³He) fuel (shown in Figure 8). The estimated gross mass of the 968-MW reactor was 112 Mg with a corresponding mass of 999 Mg for a DT-fueled system, (1Mg=1 metric ton). Optimization of this conceptual design using the FRC plasma confinement using colliding beams has led to a much more compact configuration of 33 Mg producing 100 MW (shown in Figure 9).¹¹ This reactor's plasma confinement chamber has a length of 7 meters and diameter of 0.84 meters. Half of the plasma fusion products and unfused fuel is circulated through the magnetic separatrix to a direct converter while the other half is diverted and expelled to provide propulsive thrust.

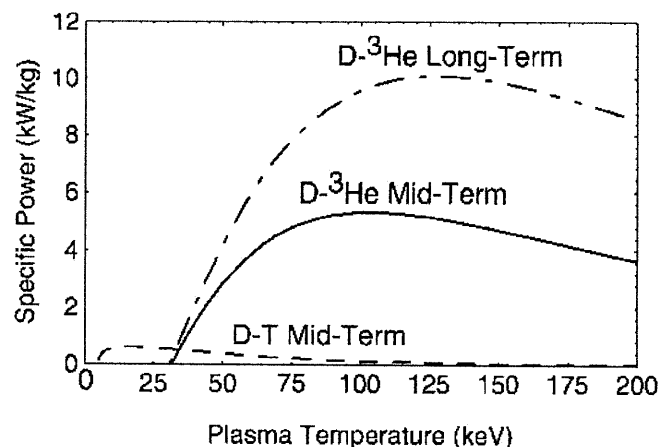

Figure 8. Specific Power as a Function of Plasma Temperature of Fusion Rocket¹¹

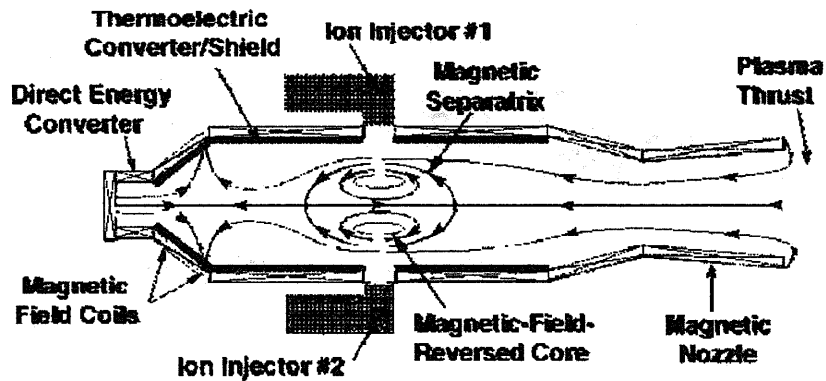

Figure 9. Colliding Beam Fusion Reactor [Cheung et al. 2004]

Dense Plasma Focus Reactors

The Dense Plasma Focus (DPF) designs that operate at extremely high plasma pressure because of the intense electrostatic pulse have been evaluated for (p,B¹¹)-fueled propulsion systems. A parametric analysis by Knecht¹² has shown that a system of 16 to 24 Mg can produce 400-900 MW of power with thrusts of 500-1000 kN at I_{sp} of 1,500-2,000 seconds. More detailed analyses of this design indicate that for a 16-Mg system using direct energy conversion coils at the thruster nozzle, (Figure 10) producing an I_{sp} of about 1300 seconds at 800 MW could generate about 1000 kN of thrust.¹³

This system is continuously fueled with H₂ and boron gas, and the electrodes are pulsed at a 10-Hz rate or higher with the >100 keV plasma fusion products and unfused fuel expelled to provide thrust after passing through a direct-energy converter cooled by a separate H₂ coolant that is also expelled in the plasma stream.

Magneto- Inertial Confinement Reactors

The concept of magnetized target fusion using field-reversed configuration plasmoids has been tested.¹⁴ A high-density compressed plasmoid is formed by a staged axial and radial compression of two colliding/merging FRC plasmas where the energy that is required for the implosion compression and heating of the magnetized target plasmoid is stored in the kinetic energy of the plasmas used to compress it. The confinement properties are expected to achieve ignition for aneutronic fuels and may lead to the smaller reactor mass for propulsion of 20 Mg producing 300 MW (shown in Figure 11).

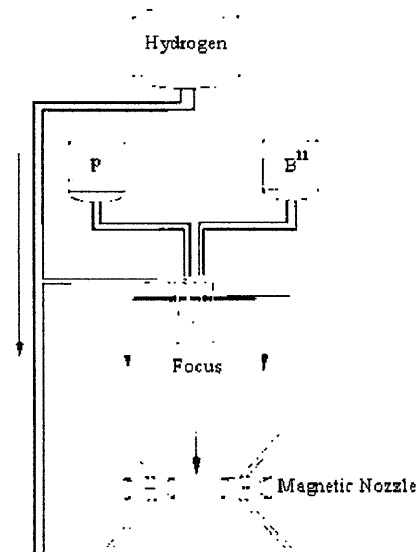

Figure 10. DPF Thruster System with Direct Conversion

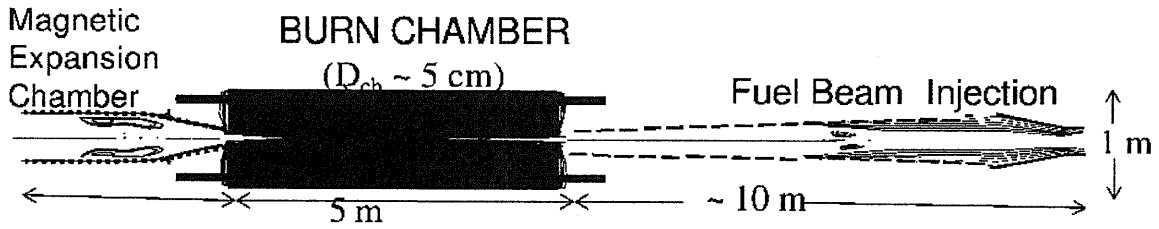

Figure 11. Magnetized Target Fusion Reactor

AIR PROPULSION

The reactor propulsion concepts described in the previous section were limited to space propulsion. The DPF reactor is the lightest concept at 16 Mg (16 metric tons) and could produce 800 MW of power with thrust levels of 1000 kN for space propulsion through ejection of high-energy ions. The application of this fusion reactor for propelling aircraft from ground to hypersonic speeds would be very difficult since converting the 800 MW of power to propellant thrust through a thermodynamically driven gas turbine would provide 15N/MW or 1.53 kg of force per MW, which is only 1,224 kg of thrust for lifting a 16,000 kg vehicle. The thrust per kilogram of reactor weight would have to go up a factor of 50 to 100 in order to lift the reactor and the aircraft it is powering.

The assistance of conventional rocket technology plus air-breathing magnetohydrodynamic (MHD)-assisted propulsion to augment aneutronic fusion plasma propulsion has been studied as depicted in Figure 12. In this concept, rocket- and turbine-based combined-cycle air-breathing engines are used for accelerating the vehicle to Mach 14.¹⁵ MHD power generation is used during Mach 7-14 air-breathing flight because it may produce hundreds of megawatts of electrical power for DPF fusion rocket system ignition. The DPF fusion rocket system could then provide additional propulsion, power, and acceleration outside the atmosphere at speeds above the Mach 14 air-breathing MHD threshold. A thrust-vectoring chemical rocket system provides additional thrust and control any time during vehicle flight.

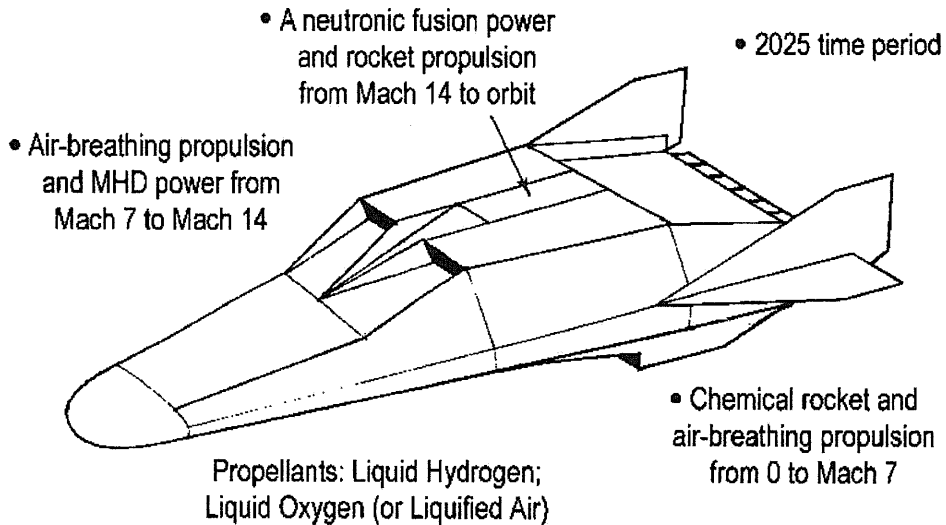

Figure 12. MHD Air-Breathing and Fusion Rocket Aerospace Plane

ION PROPULSION

Ion propulsion is a method by which the principles of electromagnetics are exploited to accelerate an ionized gas in a controlled manner. The forces involved to accelerate the plasma, by Newton's third law, act to propel an object such as a rocket or spacecraft along a given path. The classification of the different plasma propulsion designs is somewhat difficult. Some designs involve electrostatic fields only, some use magnetic fields for ionization purposes but not for ion acceleration, and some designs use both electric and magnetic fields for ion acceleration and thrust. In addition, some designs emit ions from a material anode, while other designs use electric and magnetic fields to ionize a gas by one of several methods, for example, by enhancing collisions or by using radiofrequency (RF) waves, to create a plasma. The different classes of plasma propulsion are described in the following subsections. The use of fusion reactions in an ion propulsion device could significantly enhance the energy of the accelerated ions augmenting the net thrust per watt expended. We will examine the methods of plasma ion propulsion that may benefit from aneutronic fusion.

Ion Thrusters

Ion thrusters typically emit charged particles from an anode or cathode to create an ion population. This population is then accelerated by an electric (and sometimes magnetic) field to generate thrust. Examples of ion thrusters include gridded electrostatic thrusters, Hall effect thrusters, and field-emission electric propulsion systems:

Gridded Electrostatic Thrusters. Gridded electrostatic thrusters were originally derived from a duoplasmatron design (which uses electrons from a cathode filament to ionize an introduced gas). Such designs then accelerate and focus ions into a beam, using an electrostatic potential, with a force equal to the ion mass times the strength of the electric field (Coulomb force). An external (to the plasma chamber) electron gun expels electrons into the exhaust to neutralize the system (to keep the spacecraft from charging up, pulling the ions [exhaust] back toward the spacecraft and lowering efficiency dramatically). These designs are typically low thrust and low specific impulse (I_{sp}).

Hall Effect Thruster. Hall thrusters use a magnetic field to trap electrons (which are used to ionize the gas) and use an electric field to accelerate ions to create thrust. The electrons also form a virtual cathode, in place of a physical grid, which is used to accelerate the ions. Lastly, electrons are used to neutralize the exhaust. About 30 percent of the discharge current is an electron current, which does not produce thrust. This limits the energetic efficiency of the Hall effect thruster. This design can produce a specific impulse of $\sim 1,500$ seconds and thrusts of several tens of mN up to ~ 3 N.

Field-Emission Electric Propulsion Systems. A field-emission electric propulsion (FEEP) system uses a very strong electric field to cause metal ions to be emitted from a metal tip. These ions are then electrostatically accelerated to provide thrust. An electron gun neutralizes the exhaust. This is typically a very-low-thrust system.

PLASMA THRUSTER

Plasma thruster designs usually ionize a gas contained within a chamber, which is then accelerated using electric and magnetic forces (Lorentz force). Examples of plasma thruster designs discussed in the following subsections include magnetoplasmadynamic and Lithium Lorentz Force Accelerator (LiLFA) thrusters, electrodeless thrusters, helicon

double layer designs, and the VASIMR thruster. Such systems typically have larger specific impulses (up to $\sim 10,000$ seconds) but have lower thrust per kW expended.

Magnetoplasmadynamic Thrusters

The magnetoplasmadynamic (MPD) thruster uses a gaseous fuel that is ionized in one chamber and then fed into an acceleration chamber. Electric and magnetic fields then propel the plasma through the exhaust chamber. The specific impulse and thrust both increase with power input, while the thrust per kW decreases. Exhaust velocities can reach 110,000 m/s, about 20 times greater than liquid rockets.

Electrodeless Plasma Thrusters

In this design, the plasma is accelerated by magnetized ponderomotive forces, for which nonuniform static magnetic fields and high-frequency electromagnetic fields are applied. The ponderomotive force accelerates positive ions and electrons in the same direction; thus, no dedicated exhaust neutralizer is needed. Since there are no grids and there is no physical contact between the plasma and electrodes, corrosion and spacecraft contamination issues are minimized. Because of the multiple stages involved, the thruster at constant power can also be varied to deliver either higher specific impulse and/or higher thrust.

One form of electrodeless thruster is the Pulsed Inductive Thruster (or PIT). A PIT uses perpendicular electric and magnetic fields to accelerate an ionized gas. Capacitors release an approximately 10- μ sec pulse of electric current, which generates a radial magnetic field. A circular electrical field is thus induced in the gas, causing ions to travel in the direction opposite that of the original current pulse. Since this motion is perpendicular to the magnetic field, the ions are then accelerated outward to provide thrust.

Helicon Double Layer

This design introduces gas into a tube (open at one end), which is then converted into a high-density plasma through the use of a helical antenna. Solenoid coils are also used to confine the created plasma. In the case of the helicon double layer, the plasma is then accelerated to supermagnetosonic speeds by traversing an electric double layer, which is created very close to the open end of the tube by a rapidly expanding magnetic field. The European Space Agency (ESA) has tested this design using argon gas and found that the double layer is stable enough to reliably accelerate ions. ESA is currently pursuing this technology for possible use in future missions.

VASIMR Thruster

The Variable Specific Impulse Magnetoplasma Rocket (VASIMR) is an electromagnetic thruster for spacecraft propulsion. This design is an electrodeless configuration and operates in three stages. The first stage uses RF helicon antennas to transform the gas into a plasma. The second stage uses an ion cyclotron resonance frequency (again in the radio band) to energize the plasma. The third stage uses electromagnets to create a magnetic nozzle, which converts the thermal energy of the plasma into thrust. Magnetic shielding protects all parts of the VASIMR from direct contact with the contained plasma, mitigating corrosion. The method for heating plasma in VASIMR was originally developed as a result of research into nuclear fusion. With the energy used for RF heating and the amount of propellant delivered for plasma generation, VASIMR is

capable of either generating low-thrust, high-specific-impulse exhaust or relatively high-thrust, low-specific-impulse exhaust. The intention of the VASIMR design is to bridge the gap between high-thrust, low-specific-impulse propulsion systems and low-thrust, high-specific-impulse systems. AdAstra is currently testing the VX-200 engine (a 200-kW engine). The power distribution is as follows: A helicon discharge uses 30 kWe (kilowatts, electrical) for ionizing the argon gas using RF waves and uses 170 kWe for powering the ion cyclotron resonance to heat and accelerate plasma in the second part of the engine. The specific impulse is optimally $\sim 5,000$ seconds, with a specific power of ~ 1.5 kg/kW. The mass of the VX-200 engine is estimated at ~ 300 kg. NASA intends to test this engine on the International Space Station using a large battery to power it during the tests.

Chapter 4: Applications

NEAR SPACE

Although aneutronic fusion thrusters will not be able to achieve liftoff for single-stage orbit vehicles as discussed in Chapter 3 above Mach 14, they can provide the necessary thrust to insert an air vehicle into orbit. In fact, any vehicle in orbit could benefit from such a propulsion device to dip down and maneuver in the atmosphere and return to orbit with the aid of fusion propulsion as long as it does not slow below Mach 14. This capability will allow a host of missions that include the following:

- Antisatellite threat avoidance.
- Unpredictable Earth or space target reconnaissance.
- Unpredictable Earth or space target neutralization.

The details of such applications will be the subject of separate studies. Undoubtedly current propulsion technologies are significantly limited in N/kW in propulsion capability to perform such missions for long durations. However, they may be sufficient due to the threats and targets needed to be countered at this time.

EARTH ORBIT

Space thrusters for orbital insertion and station keeping have been using hydrazine propellant and, more recently for large GEO satellites, arc jet thrusters, which electrostatically enhance the hydrazine propellant. High-power Hall Current Thrusters (HCT) that electrostatically accelerate Xe ions have been developed by NASA with discharge power levels ranging from 6.4 kilowatts to 72.5 kilowatts.¹⁶ Such devices produce thrust ranging from 0.3 to 2.5 Newtons and specific impulses up to 4,500 seconds at 1 kV. More recently, AeroJet together with Lockheed Martin Space Systems Company have qualified a 4.5-kW Hall Thruster Propulsion System (HTPS) that demonstrated 244 mN of thrust with a specific impulse of 1,981 seconds incorporating a 400-volt acceleration potential. These thrusters were flown in 2010 on military communication and surveillance satellites. Expected enhancements of these HCTs will provide higher I_{sp} near 3,000 seconds at the expense of significant lower thrust, ~ 10 mN/kW. Future broadband communication commercial and military satellites of 20- to 50-kW broadcast power will require much more efficient thruster performance in terms of mN/kW in order to satisfy the operational performance needs of their solar power systems. This provides the motivation for the development of aneutronic fusion enhanced ion thrusters.

Such a development has been proposed by transforming a conventional ion thruster into a spherical form.¹⁷ Using the IEC configuration shown in Figure 13, ions are produced in the gas discharge region through the injection and oscillation of electrons about a guide grid that is held to a slightly positive potential. The grid extracts ions from the discharge region and accelerates them toward the center of the device. It is estimated to provide 35 mN of thrust for 750 watts of input power at 500 volts, providing an I_{sp} of 3,000 seconds or 45 mN/kW superior to the advanced HCT thrusters. The addition of a 150-kWe ion beam for heating a (p,¹¹B) plasma close to ignition ($Q \sim 1$) using a magnetic guide system to redirect the nearly isotropic velocity distribution of

the MeV alpha particles for the (p,¹¹B) into a direct thrust would increase the I_{sp} to >5,000 seconds with thrust levels >5 N/kW.

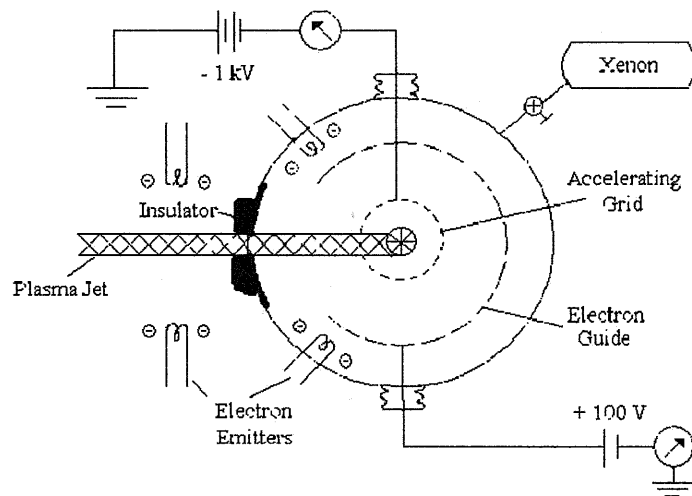
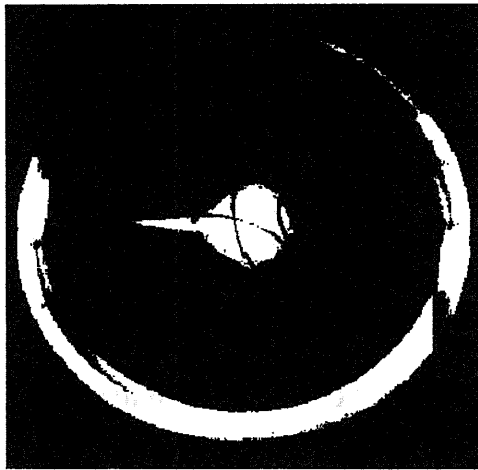

Figure 13. Design of an IEC Jet Thruster - Experimental Device (left)

INTERPLANETARY

Many of the fusion reactor applications described in Chapter 3 have been specifically applied to space propulsion. The key reason for the benefits of such systems lies in the fundamentally different nature of fusion propulsion compared to chemical or nuclear-thermal propulsion. Fusion propulsion systems pay a mass penalty for carrying their power source. However, a propellant mass savings results from the high thrust per unit mass that arises from high exhaust velocity that overcomes the power-source mass penalty. These potential performance enhancements are shown in Figure 14, which illustrates fusion propulsion's capabilities for fast transport of humans or efficient transport of cargo between circular solar orbits for Earth-Mars one-way rendezvous missions.¹⁸

In order to achieve the efficient solar system travel shown in Figure 14, propulsion systems must achieve specific powers of at least 1 kW/kg at exhaust velocities of $\sim 10^5$ - 10^6 m/s, leading to thrust-to-weight ratios of $\sim 10^{-3}$. The required range of parameters and a comparison with chemical and nuclear thermal propulsion options appears in Figure 15.¹⁹ The capability of tuning the exhaust velocity over factors of 10-100 is a desirable feature that facilitates energy intensive missions. For the same delivered payload the fraction of the propellant and nonpayload mass is significantly minimized for fusion propulsion as compared to the other propulsion options.

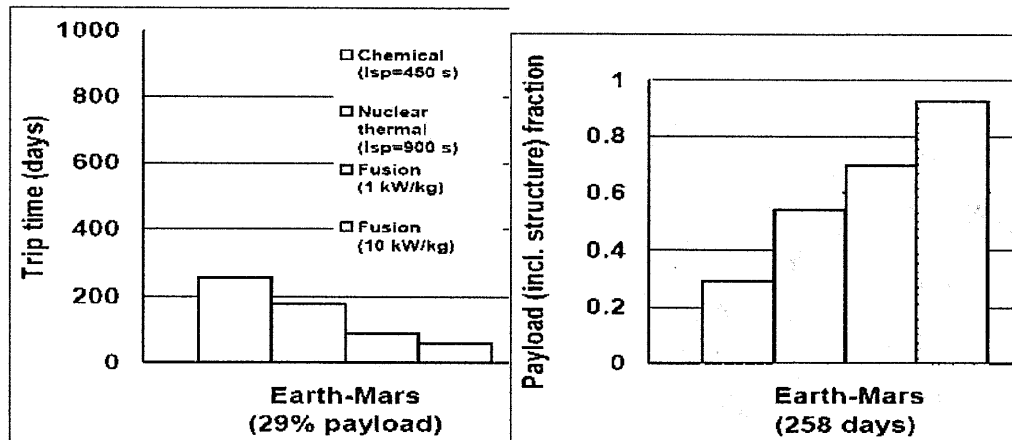

Figure 14. Comparison of Fusion, Nuclear-Thermal, and Chemical Propulsion for Same Payload.

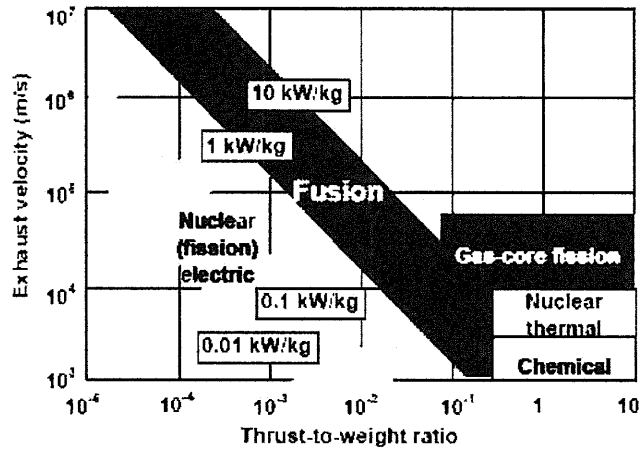

Figure 15. Thrust-to-Weight Ratio and Exhaust Velocity Regimes for Various Long-Range Space Propulsion Options.

INTERSTELLAR

The ability of fusion propulsion to carry payloads or travelers to a habitable star tens of light-years away will be limited by the amount of fusion fuel it can transport or gather along its route. A simple calculation of the amount of energy to move a space-shuttle-sized vehicle (100 Mg) to the nearest star, Alpha Centauri, indicates a minimum amount of energy in the mass equivalent of 10^6 kg. However, in 1960 Robert Bussard proposed the use of magnetic fields to scoop interstellar hydrogen to fuel a fusion rocket to propel a spacecraft now known as the Bussard Ram Jet (shown in Figure 16).²⁰ Although interstellar hydrogen does not fuse, Bussard proposed the use of the stellar carbon-nitrogen-oxygen (CNO) cycle in which carbon is used as a catalyst to burn hydrogen through the strong nuclear reaction. However, the size of the scoops and the fusion power required to maintain them makes this concept unlikely to be realized.

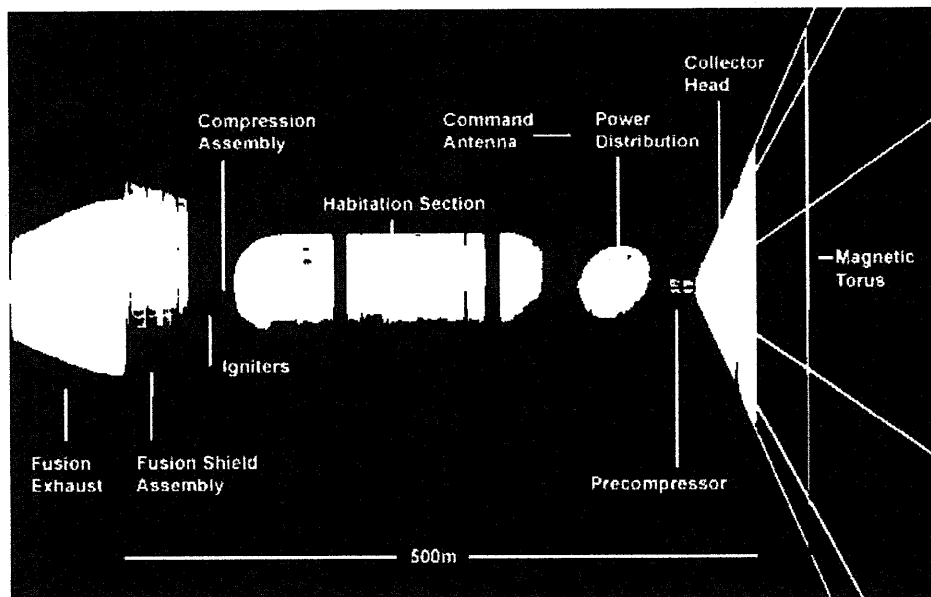

Figure 16. Bussard Ram Jet (www.bibsos.com)

Chapter 5: Recent Developments

U.S. DOE PROGRAMS

The current U.S. Department of Energy fusion program is administered by the Office of Fusion Energy Sciences (<http://www.science.doe.gov/ofes/>). The FY2010 budget was \$421 million, with over half devoted to tokamak plasma physics and experimental facilities at Princeton Plasma Physics Lab, MIT, and General Atomics. The Advanced Concepts and High-Energy-Density Laboratory Plasma Physics (HEDLPP) programs, which support plasma confinement theory and experiments for innovative fusion reactor concepts and fusion propulsion, are funded at ~\$20 million. The HEDLPP program covers the following areas:

- Radiative hydrodynamics.
- Laser-plasma and beam-plasma interaction.
- Fusion burn.
- Materials under extreme conditions.
- Dense plasmas in ultrahigh fields.
- Laboratory astrophysics.

Technology development funding is directed toward tokamak-related reactors with \$135 million contributed to ITER. The National Ignition Test Facility is funded by DOE's National Nuclear Security Administration and is dedicated for nuclear weapons simulation. The NNSA-funded research also includes Magneto Target Fusion experiments at Sandia and Lawrence Berkeley National Labs.

INTERNATIONAL PROGRAMS

The International Thermonuclear Experimental Reactor (ITER) is a joint undertaking of the European Union, China, India, Japan, Korea, Russia, and the United States. The goal is to demonstrate deuterium-tritium (DT) fusion ignition in a minimum-sized tokamak confined plasma. The initial plans were to operate ITER as early as 2002 some 10 years after the planned TFTR and JET experimental results shown in Figure 17. However, delays in TFTR and JET test results, which augmented the size of the ITER plasma to 6 meters in major radius and 6 meters in height, had pushed the ITER operation out to 2020 at a cost of \$20 billion. It has since been downscaled in operating requirements due to the cost and problems associated with tritium fuel and containment with a 2025 operating date and cost of \$25B. The operating time of an ignition burn will be limited to minutes. These constraints have been imposed due to the excessive costs for the 200 MW power plant needed to supply the energy to ignite the tokamak plasma as well as the 36 kg of tritium needed for its initial fueling. In order to compensate for this a Demonstration Power reactor is planned to follow 5 yrs later at a substantially higher cost.

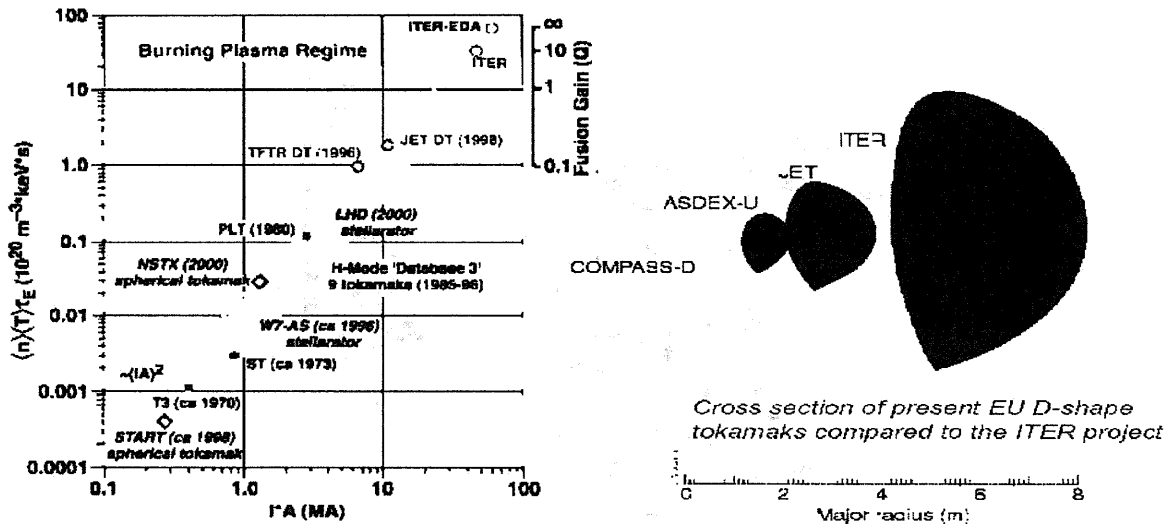

Figure 17. Progress in Tokamak Magnetic Confinement Fusion

The issues of tokomaks as a potential source of fusion power are dramatized by the recent graphic (Figure 18) published in the American Nuclear Society's Fusion Energy Division Newsletter (Dec 2007) depicting the GE Next-Generation Boiling-Water Reactor (Economic Simplified BWR). The reactor, which costs about \$3 billion, will produce enough thermal energy to generate 1.2 GWe (gigawatt electrical). Its fuel rods will have to be replaced every 3 years. In an operating fusion tokomak reactor, the first wall and neutron absorbing and tritium breeding thermal blanket would have to be replaced every 5 years. Two orders of magnitude more volume and an extremely complex thermal transport system will be at a considerably greater cost and down time for the plant. With the recent and predicted escalation of fossil fuel costs, nuclear power has become economically competitive with coal and oil plants. It is clear that a tokomak power plant could not compete with the fission plant at current market energy prices.

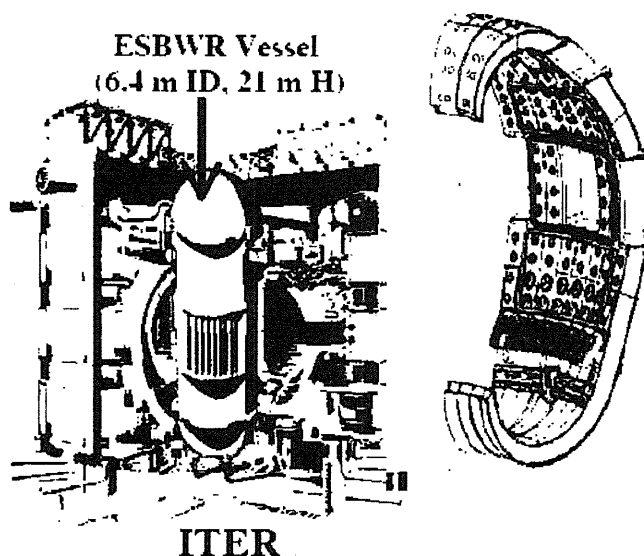

Figure 18. ITER Design Concept With BWR Size and Blanket Segment

NASA PROGRAMS

From 1995 until 2002, NASA had funded advanced space propulsion studies through Marshall Space Flight Center. These studies included the application of fusion and matter-antimatter propulsion for space exploration missions. Recently, NASA has initiated a 5-year high-power electric propulsion demonstration program to develop the technologies for manned missions to Mars in a 20-plus-year timeframe. The program funding may allow initiatives for (p,¹¹B) fusion-assisted propulsion, which may provide significant gains in thrust and I_{sp} without reductions in thrust per watt expended.

PRIVATELY FUNDED PROGRAMS

There are a number of capital investment startups that have been developing fusion reactor technology with funding of several million dollars to greater than \$50 million each. All these companies are basing their development on unique concepts or those described in Chapter 3. Table 4 summarizes these companies. Both Lawrenceville Plasma Physics (which uses DPF, dense plasma focus, confinement) and TriAlpha (which uses beam-heated FRC, field reversed configuration) have been shown conceptually to have low-mass aneutronic fusion propulsion systems that could use direct conversion for power and plasma ion for propulsion. Their success in the next few years may accelerate the implementation of aneutronic fusion propulsion.

Table 4: Advanced Fusion Concept Reactor Companies

COMPANY	CONCEPT	FUEL	FUNDING
Lawrenceville Plasma Physics	Dense Plasma Focus	(p, ¹¹ B)	Current: \$4M Needed: \$4M
Electron Power Systems	Colliding Plasma Tori	DD	Current: \$6M Needed: \$8M
General Fusion	Pb-Li spun liquid compression	DT	Current: \$10M Needed: \$10M
EMC2	Polywell Electrodeless IEC	DD, (p, Li), (p, ¹¹ B)	Current: \$11M Needed: \$100M
TriAlpha	Beam-Heated Field Reversed Conf.	(p, ¹¹ B)	Current : \$50M Needed: \$100M

Chapter 6: Future Developments

NEAR-TERM DEVELOPMENTS

Near-term developments of fusion propulsion will include the timeframe from 2010 to 2020. It will leverage the privately funded developments in DPF, FRC, and IEC for commercial fusion reactors, as well as the DOE developments of magneto-inertial fusion, including magnetized target fusion and high-density plasma physics experiments. During this timeframe, it is expected that one or more of these fusion concepts will develop sufficient experimental data or even achieve sustained ignition breakthroughs that will allow the technology push to proceed into aerospace propulsion applications. The IEC thruster described in Chapter 4 is a near-term candidate to replace HCTs with high I_{sp} and thrust augmented by aneutronic fusion. At the same time, associated technology development from the mainline DOE programs and ITER tokamak programs will contribute to the important areas of the following:

- Super conducting magnets.
- Energy storage supercapacitors.
- Fuel storage systems.
- Fuel ion injection accelerators.
- Compact high-voltage converters.
- Direct ion energy converters.
- Plasma propulsion systems.

Experiments and system analyses to validate the applicability of aneutronic fusion propulsion should be conducted early on, since they may bias the path taken for the various reactor and propulsion combinations.

Table 5: Emerging Technologies

Technology	Application	Supports	Status
High-temperature plasma containers	Aiding confinement, supporting fusion architecture, surviving sustained reactions / lifetime	ALL	Need lightweight materials to withstand the fusion-burning environments repeatedly.
Plasma injection schemes	To supply plasma for startup, sustained reactions, symmetry, energy deposition	ALL	There needs to be an efficient and effective way to get fuel stored, delivered, and ignited.
Stable magnet configurations	Needed for sufficient confinement times / ignition densities, minimize instabilities, optimal propulsion profiles	CBFR, IEC, DPF	Some experiments are in progress, but designs will evolve as limitations are encountered.
Lightweight high-strength magnets	Needed for aerospace application, cost effective launch and deployment, thermal tolerance, superconductivity at workable temperatures.	IEC, CBFR	High-temperature ceramics still need to be molded to a launch and deployment survivable standard. Much material science and testing are needed.
Propulsion nozzles for efficient energy channeling	Optimizes efficiency of propulsion, supports direct conversion, support viable missions	ALL	This is the result of current studies and is specific to design limitations and support.
Lightweight particle accelerators for aerospace applications	For particle beam injection, energy deposition, confinement, and fusion support	IEC, CBFR	Most experiments are currently ground oriented – need to transition to flight.
Direct-energy conversion schemes	Needed for high Q and efficient propulsion schemes	ALL	Currently under study for recovering energy from charged particle beams, magnetic fields, thermal recycling.
High-energy-density batteries and supercapacitors	Needed for energy storage and startup operations	ALL	Application of nano materials and thin film manufacturing have accelerated development
Fuel storage systems	Cryogenic H ₂ , D ₂ and B gas storage	ALL	Development of solid fuel storage will reduce mass and costs.

MID-TERM DEVELOPMENTS

Mid-term developments for the timeframe 2020 to 2030 will include engineering designs and ground testing of the selected aneutronic reactor concepts that have the highest probability of success. Universities, national labs, and private companies all contribute designs. Some will be further along by 2020 than others due to funding, investments, scientific breakthroughs, or evolutionary modifications. Systems engineering analysis for aerospace applications must accompany the ground-based experiments, material science, and physical analysis to achieve a solution that can transition to viable aerospace engineering prototypes from plasma fusion propulsion research.

Development of high-temperature superconductors that can be machined into multi-Tesla capable confinement magnets is a current area of research. Recent advances in high-temperature superconductors are driven by the sensitivity of semiconductor quantum interference device (SQUID) circuits, the desire for improvements in MRI, improved energy storage, transformers and delivery systems for utility companies, and generators and motors for submarines for the Navy.

Here, the materials must not only be compatible with lightweight cryogenics (such as pulse tube compressors), but they must be less brittle and capable of molding into coil geometries with material compatibilities across a broad range of temperatures and stress loads. A suitable substitute for the Nb₃SnCu or NbTi in ground-based reactor designs with lighter weight components for both the superconducting materials and the above critical temperature conductor substrates must be found. Building a one-of-a-kind coil geometry large enough to integrate into a plasma fusion engine and able to survive the local environment will likely be an expensive proposition. In the near term, although scale models are useful, the physics and densities change with size. Although this estimate may be optimistic, with concerted efforts by the magnet companies it should be achievable.

Energy efficiency is paramount to effective propulsion, fuel consumption, and affordability. Experiments for direct energy conversion might include the following:

- Strategic electrode placement to recover power from unconfined charge particle emanation.
- Inductive coils for recovery of excess magnetic field energy.
- Channeling of thermal energy to heat exchangers or augmented electric power generators.

Fusion experiments such as Vlasov modeling, magnetohydrodynamic (MHD) models, and electrodynamic relaxation models for particle transport, fluid/plasma dynamics, collision-dominated transport, and fusion cross-section predictions need to be applied. Figure 19 summarizes all of these proposed development paths.

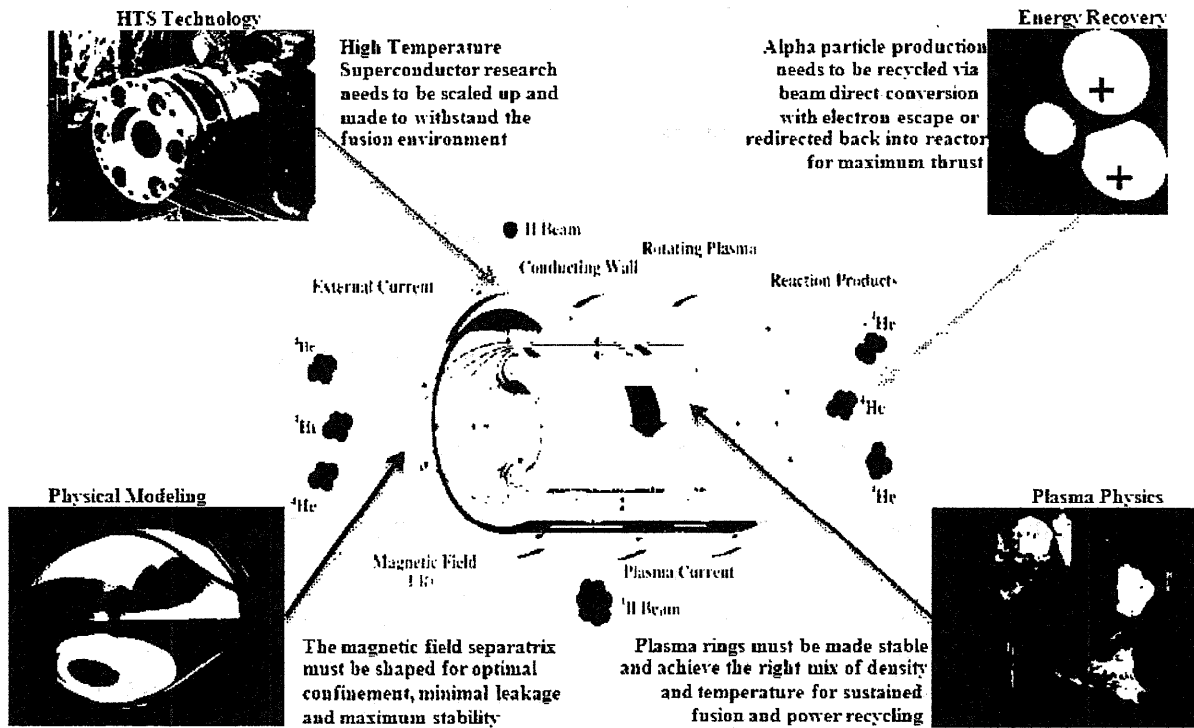

Figure 19. Experiments To Prove a Plasma Fusion Propulsion Concept

FAR-TERM DEVELOPMENT

In the far term timeframe from 2030 to 2050, design integration of the optimized aneutronic fusion reactors and propulsion systems into aeronautical platforms must be conducted followed by prototype flight tests. Although it is difficult at this point to say which technology will ultimately transition to application, ultimately, industrial collaboration will be necessary to bring forth the propulsion system experience with the fusion plasma physics and sustained ignition engineering and the right mix of material science. The platforms will be launched from the ground, air, or space depending on ease of design integration, availability of secondary boosting technology, and ultimate funding limitations.

A roadmap to the development of aneutronic fusion propulsion is shown in Figure 20. The journey begins with a series of experiments specifically designed to address the functionality and practicality of fusion propulsion concepts. These experiments should consist of magnetic field plasma interactions, quenching of induced instabilities, and supplemental analysis to indicate feasibility for basic energy transport and sustainment.

After the physics has been demonstrated with numerous field plasma interaction and confinement experiments, the focus can then be more on practical considerations. Although this transition is certainly not abrupt, a set of success criteria including plasma beta greater than unity, successful ignition, sustained ignition, power balance (at least theoretical), and basic concept designs should be well established.

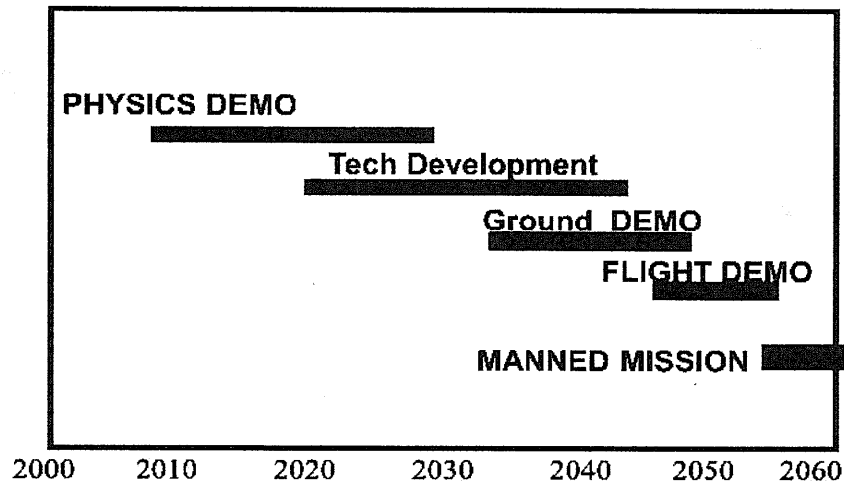

Figure 20. Roadmap to Aneutronic Fusion Propulsion Development

Design trades and evaluation can then ensue with confinement vessel design (including fuel supply and introduction), basic exhaust control modeling for regulation and maximum efficiency, crew and equipment safety concepts, effective launch and deployment concepts, and complete end-to-end power train and energy recovery concept implementation.

Ground demonstrations have been conducted during all of the previous phases, but a complete end-to-end demonstration of the working concept is necessary before deployment. This demonstration is the culmination of the design physics and engineering models with a complete simulation from launch, execution, and return to Earth.

The estimated date for a manned mission is contingent upon the successful execution of the prior technology phases and again, success depends upon thorough execution, complete analysis, proven concepts, engineering models, and significant and careful investment strategies.

Chapter 7: Conclusions

Much of the groundwork (literally) for aneutronic fusion propulsion has been accomplished, including conducting fusion experiments, development of design concepts, and the analysis of applications to aerospace propulsion. Transitioning these concepts to space is an immense challenge given the large mass, power requirements, and support engineering for power conversion, energy recovery, and fuel storage. This transition, however, may depend upon the success of the developments of privately funded ventures attempting to develop terrestrial power. Notwithstanding such developments, their application for both military and space or near-space applications requires a much lower threshold for return on investment than terrestrial power.

Pulsed-powered DPF or IEC aneutronic fusion thrusters may have near-term applications to replace current satellite ion thrusters. This could be extended to the very high-power domain of beam-assisted FRC for manned interplanetary flight. The near-space domain will require major improvements in technology to reduce system mass since the size enters the MW range. The application to the aircraft domain will require further developments in technology to reduce system mass and/or the use of DT fuels, which present other potential safety issues. Aneutronic fusion propulsion will not be practical beyond the solar system unless breakthrough propulsion physics is developed that can assist the flight to the next stellar system where fusion thrusters can then be used.

Whether it is reducing rows and rows of capacitor banks to pulse generators, shrinking immense superconducting magnets to a more compact and lightweight geometry, or engineering integrated fusion propulsion systems to fit onto a booster rocket, the physicists who pioneered much of the reactor and propulsion technology must now work side-by-side with the space systems companies to explore viable propulsion systems from implementation to on-orbit maintenance and attitude control. The future needs to be focused more on science and engineering and less on science fiction.

Chapter 8: Endnotes

- ¹ Elmore, W.C., J.L. Tuck, and K.M. Watson, "On the inertial-electrostatic confinement of a plasma," *Phys. Fluids*, **2**, 239, 1959.
- ² Farnsworth, P.T., "Electric Discharge Device for Producing Interactions Between Nuclei, U.S. Patent No. 3,358,402, issued June 28, 1966, initially filed May 5, 1956, reviewed Oct. 18, 1960, filed Jan. 11, 1962.
- ³ Hirsch, R.L., Experimental studies of a deep, negative, electrostatic potential well in spherical geometry," *Phys. Fluids*, **11**, 2486, 1968.
- ⁴ Rider, T.H., "A general critique of inertial-electrostatic confinement fusion systems," *Phys. Plasmas* **2** (6), 1853, 1995.
- ⁵ Bussard, R.W., "Some physics considerations of magnetic inertial-electrostatic confinement: A new concept for spherical converging-flow fusion," *Fusion Tech.*, **19**, 273, 1991.
- ⁶ Barnes, D.C., R.A. Nebel, and L. Turner, "Production and application of dense Penning trap plasmas," *Phys. Fluids*, **B 5**, 3651, 1993.
- ⁷ Nebel, R.A. and D.C. Barnes, "The periodically oscillating plasma sphere," *Fusion Tech.*, **38**, 28, 1998.
- ⁸ Park, J., R.A. Nebel, S. Stange, and S. Krupakar Murali, "Experimental observation of a periodically oscillating plasma sphere in a gridded inertial electrostatic confinement device," *Phys. Rev. Lett.*, doi: 10.1103/Phys. Rev Lett., 95.015003, 2005.
- ⁹ Thio, Y.C.F., "Status of the US program in magneto-inertial fusion," *J. Phys.: Conf. Ser.* 112 042084, doi: 10.1088/1742-6596/112/4/042084, 2008.
- ¹⁰ J.F. Santarius and B.G. Logan, "Generic Magnetic Fusion Rocket Model," *Journal of Propulsion and Power* **14**, 519 (1998); *Propulsion and Power* **14**, 519 (1998); UFD-914 April 1993 presented at 29th AIAA Joint Propulsion Conf, paper AIAA-93-2029, June 28-30, 1993. Monterey, CA
- ¹¹ F.J. Wessel, M.W. Binderbauer, N. Rostoker, H.U. Rahman, and J.O'Toole, "Colliding Beam Fusion Reactor Space Propulsion System," *Space Technology and Applications International Forum--2000* (American Institute of Physics, Albuquerque, NM, 2000), p. 1425.
- ¹² Knecht, S.D., R.H. Thomas, F.B. Mead, G. H. Miley and D. Froning, "Propulsion and Power Density Capabilities of Dense Plasma Focus (DPF) Fusion Systems for Military Aerospace Vehicles", in *Proceedings of Space Technology and Applications International Forum (STAIF-006)*, edited by M. El-Genk, AIP Conference Proceedings, p. 1232-1239.
- ¹³ Thomas, R., Yang, Y., Miley, G.H., Mead, F.B., "Advancements in Dense Plasma Focus for Space Propulsion," in *Proceedings of Space Technology and Applications International Forum (STAIF-005)*, edited by M. El-Genk, AIP Conference Proceedings 746, Melville, New York, 2005 pp. 536-543.
- ¹⁴ J. Slough, R. Milroy, T. Ziemba and S. Woodruff., "Compression, Heating and Fusion of Colliding Plasmoids by a Z-theta Driven Plasma Liner," *J. of Fusion Energy* **26**, 191, (June 2007).
- ¹⁵ H. Froning, "Combining MHD Air breathing and Aneutronic Fusion for Aerospace Plane Power and Propulsion," 14th AIAA/AHI Space Planes and Hypersonic Systems and Technologies Conference, June 2006.
- ¹⁶ K. DeGrys, B. Welander, J. Dimicco, S. Wenzel, B. Kay, V. Khayms, and J. Paisley "4.5 kW Hall Thruster System Qualification Status," *Proc. 41st AIAA/ASME-SAE-ASEE Joint Propulsion Conference*, July, 2005
- ¹⁷ G. Miley, H. Momota, L. Wu, M. Reilley, V. Teofilo, R. Dell, and R. Hargus, "Space Probe Application of IEC Thrusters," *Fusion Science and Technology* **56** 1, 533-539 July 2009.
- ¹⁸ F. Thio et al., "A Summary of the NASA Fusion Propulsion Workshop 2000", *Proc. 37th AIAA/ASME/SAE/ASEE Joint Propulsion Conference*, July 2001.
- ¹⁹ J. Santarius and F. Thio, "Fusion Propulsion: Attractiveness and Issues," *Proc. of 31st AIAA Plasmadynamics and Lasers Conference*, June 2000.
- ²⁰ Bussard, R. W., "Galactic Matter and Interstellar Flight," *Astronautica Acta*, **6**, 179-194, 1960.