



LONDON BREED
MAYOR

CITY AND COUNTY OF SAN FRANCISCO
Department of Police Accountability
ONE SOUTH VAN NESS AVENUE, FLOOR EIGHT
SAN FRANCISCO, CA 94103



PAUL DAVID HENDERSON
EXECUTIVE DIRECTOR

Public Records Release

The Department of Police Accountability (“DPA”) is producing records in response to a public records request made under California Penal Code § 832.7.

The responsive records in this production include documents related to SF DPA Case No. 0662-08. The case files are available to view or download on <https://sfdpa.nextrequest.com/requests/20-2> in a folder labeled “0662-08.”

As a preliminary matter, some of the above referenced file contains allegations of misconduct that are not subject to disclosure. Penal Code § 832.7 requires that peace officer personnel files be confidential except for four categories: (1) officer involved shootings, (2) uses of force that cause great bodily harm, (3) sustained findings of sexual assault, or (4) sustained findings of dishonesty. If a file therefore qualifies for disclosure under one of those four categories but also contains additional, unrelated misconduct, the unrelated conduct remains confidential pursuant to Penal Code § 832.7 and is redacted.

Redactions have been made to these records pursuant to the following exemptions:

Redaction Code	Description
1 PII	Personally Identifiable Information. California Penal Code § 832.7(b)(5)(A), Government Code 6254.3 §§ (a), (b)(1). Personal data or information, such as a home address, telephone number, or identities of family members, other than the names and work-related information of peace and custodial officers. Personal employee information such as social security numbers, birth dates, personal email addresses, and confidential law enforcement identification numbers.
2 ID	Identity of Complainants and Witnesses. California Penal Code § 832.7(b)(5)(B), SF Admin. Code §§ 67.24(d)(1), (3) – To preserve the anonymity of complainants, witnesses, and confidential sources.
3 CI	Confidential Information. California Penal Code § 832.7(b)(5)(C). To protect confidential medical, financial, or other information of which disclosure is specifically prohibited by federal law or would cause an unwarranted invasion of personal privacy that clearly outweighs the strong public interest in records about misconduct and serious use of force by peace officers and custodial officers.
4 SD	Significant Danger. California Penal Code § 832.7(b)(5)(D) – Disclosure of the record would pose a significant danger to the physical safety of the peace officer, custodial officer, or another person.
5 POBRA	Public Safety Officers Procedural Bill of Rights Act. California Penal Code § 832.7(a) - Except as provided in subdivision (b), the personnel records of peace officers and custodial officers and records maintained by any state or local agency pursuant to Section 832.5, or information obtained from these records, are confidential and shall not be disclosed in any criminal or civil proceeding except by discovery pursuant to Sections 1043 and 1046 of the Evidence Code.

6	PIND	Public Interest in Non-Disclosure. California Penal Code § 832.7(b)(6) – Information, including personal identifying information, where, on the facts of the particular case, the public interest served by not disclosing the information clearly outweighs the public interest served by disclosure of the information.
7	CSD	Confidential State Database. California Penal Code §§ 11105, 11145, 13100 et seq. CORI data (personal identifiable criminal history) and CLETS data (California Law Enforcement Telecommunications Systems).
8	LEI	Law Enforcement Information and Police Investigatory Files. SF Admin Code Chapter § 67.24(d). Confidential law enforcement information, including investigative techniques, procedures, and information whose disclosure would endanger law enforcement personnel.
9	CCP129	California Code of Civil Procedure § 129. Photographs of the body, or any portion of the body, of a deceased person, taken by or for the coroner at the scene of death or in the course of a post mortem examination or autopsy.
10	PP	Personal Privacy. California Government Code § 6250, 6254(c). Personnel, medical, or similar files, the disclosure of which would constitute an unwarranted invasion of personal privacy.
11	WI5328	California Welfare & Institutions Code § 5328. Confidential mental health records.
12	J	Juvenile Records. California Welfare & Institutions Code § 827, California Government Code § 6254(k). Juvenile records.
13	P	Attorney Privilege. California Government Code §§ 254(k), 6254.25, 6276.04, Evidence Code § 954. Attorney-client privilege.
14	E1040	Official Information Privilege. California Evidence Code § 1040 (a) - Information acquired in confidence by a public employee in the course of his or her duty and not open, or officially disclosed, to the public prior to the time the claim of privilege is made.

Please note that the DPA has elected to produce transcripts in lieu of audio recordings. The DPA has taken this approach because redacting and producing audio files is time consuming and expensive. If you remain interested in certain recorded materials after reviewing the transcripts, please identify the materials and the DPA will provide you with a cost sheet for reproducing the recordings. You may then select which recordings you would like produced.

Prepared by: Susan Gray, Staff Attorney

OFFICE OF CITIZEN COMPLAINTS - USE BLACK INK ONLY!

1 Day, Date & Time Complaint Received
~~5-19-07~~ WED, AUG. 13, 2008

ID [REDACTED]

Complaint Against: Personnel Policy Procedure

How Received: Person Phone Letter SFPD Mail-In Other : (specify) N/A

2 Primary Complainant: Co-Complainant

ID [REDACTED]
 Last Name First Name Middle Initial

HOME ADDRESS: Homeless in
 Street Apartment

City State Zip

WORK ADDRESS: None
 Street Apartment

City State Zip

3 Personal Information

Age: 52 Date of Birth: [REDACTED] PII

Sex: M

Ethnicity: Hispanic

Occupation: Painter

4 Telephone Numbers:

Home: ()

Work: ()

5 Location of Occurrence:
Lower Great Highway

6 Type of Place Street 7 District SUNSET

8 Day, Date, & Time Of Occurrence:
MAY 19 2007 P.M. 12:15
 (Circle one)

9 Incident Report or Citation No
 ID [REDACTED]

10 SECONDARY COMPLAINANT? Yes No Witnesses? Yes No (If "Yes", attach separate sheet of paper.)
 Taped Interview? Yes No Criminal Case Pending in Relation to this matter? Yes No

11 Injuries Claimed? Yes No Injuries Visible? Yes No Drug/Alcohol Related? Yes No
 Photos Taken? Yes No By: Photo Lab O.C.C. Other: CSI

Type of Injury: Dog bites, GUN shot Medical Release Signed? Yes No

12 Activity	13 Type	14 DISP.	15 Uniform Yes No	16 Rank	17 Member's Name & Star Number POBRA	18 Unit	19 Svc	20 Sex	21 Eth
Driver			<input checked="" type="checkbox"/>		[REDACTED]			M	W
Passenger			<input checked="" type="checkbox"/>		CRAVALHO 1783	SBI		M	W
					SEE CONTINUATION FORMS				



Police Commission for the City and County of San Francisco
OFFICE OF CITIZEN COMPLAINTS



~CITIZEN COMPLAINT FORM~

INSTRUCTIONS FOR COMPLETION OF THE CITIZEN COMPLAINT FORM:

Please answer questions in blocks 2, 3, 4, 5, 8, 11, 15, 17, 20, 21 & 22. Leave all other blocks blank unless you know the information requested. Please print all information in English. If you do not have a telephone number, enter a message number or the number of a neighbor, friend or relative in block 4. If witnesses are available, write their names, addresses and telephone numbers on a separate sheet of paper and attach it to your complaint. Do not write them on the complaint form. If you do not know the officers name or badge number, include a complete physical description in the narrative (22). Print your narrative. Explain what happened from beginning to end. Be specific as to the nature of your complaint against each officer. Include who, what, where, when and why. If you need additional space, use separate sheets of paper and attach them to the complaint. **YOUR STATEMENT MUST BE A TRUE AND ACCURATE ACCOUNT OF THE INCIDENT** to the best of your knowledge and belief, and must be signed by you in block 22. If you have questions or need help, please call the OCC at (415) 597-7711 between 8:00 a.m. and 5:00 p.m., or leave a message with our answering service after 5:00 p.m. You may also contact your local neighborhood center for help. Interpreters can be provided at no charge.

填寫公民投訴書說明：

請回答第 2, 3, 4, 5, 8, 11, 15, 17, 20, 21 及 22 項問題。除非您知道我們所要求的資料，否則請將其他各項留空。所有資料，務請以正楷填寫清楚。如果您沒有電話號碼，請在第 4 項填上有可能聯絡您的電話號碼，或鄰居、親戚、朋友的號碼。如果有證人，請用另一張紙寫上他們的姓名，地址及電話，和投訴書夾在一起；切勿寫在投訴書上。如果你不知道涉及事件的警務人員姓名或編號，請將該員的身體特徵，以正楷詳盡寫在第 22 項上。請清楚說明事件的過程，及投訴的類別，包括涉及何人、何事、何處、何時及何由。如您認為投訴書不夠您填寫，可以另紙填寫資料，夾在投訴書上。您應根據您所知道及所相信的事實填寫資料，必須真實及正確；填妥請在第 22 項簽名。如有疑問或需要幫助，請在上午八時至下午五時，致電 (415) 597-7711「公民投訴組」，或在下午五時後，在該組的電話錄音機上留言。您亦可以與有免費翻譯員服務的「華埠建民中心」求助，電話 415-391-5099。

INSTRUCCIONES PARA LLENAR EL FORMULARIO DE QUEJAS DE LOS CIUDADANOS: Por favor conteste las preguntas de las casillas 2, 3, 4, 5, 8, 11, 15, 17, 20, 21 & 22. Deje sin contestar las demas preguntas a menos que sepa la información solicitada. El formulario debe ser contestado en Ingles. Si usted no tiene telefono escriba en la casilla 4 el número de un servicio de mensajes, o el de un vecino, amigo o pariente. Escriba en una hoja separada los nombres, direcciones y telefonos de los testigos (si los hay), y adjunte ésta información al formulario. En caso de que no conozca el nombre o número de insignia de los oficiales, incluya una descripción fisica completa (22). Describa los hechos en forma completa, sea especifico. Incluya quien, que, donde, cuando y porque. Su declaración debe ser un recuento exacto y verdadero del incidente y debe estar firmada por usted (22). Para pedir información o solicitar ayuda visite nuestras oficinas locales o llamenos al numero (415) 597-7711 de 8:00 AM - 5:00 PM. El servicio de interpretacion es gratis. Formularios tambien pueden ser obtenidos en La Raza Information Center--- (415) 863-0764.

PARAAN NG PAGSAGOT SA PORMANG ITO (CITIZEN COMPLAINT o REKLAMO NG MAMAMAYAN)

Mangyaring sagutin ang mga tanong sa blokeng 2, 3, 4, 5, 8, 11, 15, 17, 20, 21, at 22. Kung wala kayo ng impormasyon hinihingi dito, paki-iwanan blanko ang blokeng hindi masagot. Paki-imbag ang lahat na sagot ninyo. Kung wala kayong telepono, paki-sulat lang ang inyong "message number", o ang numero ng inyong kapit-bahay, kaibigan, o kamaganak. Kung mayroon kayong mga saksi o testigo, isulat sa ibang papel ang kanilang mga pangalan, mga tirahan, at mga telepono at ikabit ito sa reklamo ninyo. Huwag gagamitin ang pormang ito. Kung hindi ninyo alam ang pangalan ng pulis o ang numero ng kanyang tsapa, isama sa inyong salaysay ang hitsura at pagmumukha ng pulis. Ilimbag ang inyong salaysay. Liwanagin lahat ang nangyari magmula sa umpisa hanggang sa katapusan. Tiyakin o siguraduhin ang inyong sinusumbong o renireklamo. Sabihin o ilarawan kung sino, ano, saan, kailan at bakit sa pangyayari. Kung kulang ang pagsusulatan dito gumamit ng ibang papel at ikabit ito sa sumbong ninyo. Sa inyong kaalaman at paniniwala, ang inilalahad ninyong nangyari ay dapat lubos na katotohanan at walang kamali-mali at kailangan ninyong pirmahan ang sumbong ito sa blokeng bilang 22. Itanong sa amin kung alinman dito ang hindi maliwanag sa inyo. Kung kailangan ninyo ng tulong, paki-tawagan kami, OCC, telepono (415) 597-7711. Maaring tawagan din ninyo ang Philippines American Consul sa telepono (415) 626-0773 sa pagitan ng alas--otso ng umaga at alas--singko ng hapon o mag-iwan ng pahatid o "message" sa aming "answering service" paglampas dng alas--singko ng hapon.

PC #1511

After you have completed this form, return it to the Office of Citizen Complaints by folding it along the lines below so that the address shows on the outside. Drop in any mailbox. NO POSTAGE NECESSARY IF MAILED IN THE UNITED STATES.

在您填妥本投訴書後，請沿摺線摺妥（地址在外），投入郵箱，寄回「公民投訴組」。在美國境內寄出，不需郵費。

Despues de completar la forma, doblela sobre las lineas marcadas y depositela en el buzón. No necesita estampilla (sello postal).

Matapos buuin ang pormang ito, tiklupin sa mga linyang nakatatak sa baba upang makita sa labas ang aming "address". Ihulog sa anumang buson o "mailbox". Hindi kailangan ng selyo kung ipadadala lang sa loob ng America.

OFFICES LOCATED AT:
480 Second Street, Suite 100
San Francisco, CA 94107

SAN FRANCISCO CA 941

06 AUG 2008 PM 5:11

NO POSTAGE
NECESSARY
IF MAILED
IN THE
UNITED STATES

ID, PII

RECEIVED
AT OCC

2008 AUG 13 P 2:27

BUSINESS REPLY MAIL

FIRST CLASS MAIL PERMIT NO. 22978 SAN FRANCISCO, CA

POSTAGE WILL BE PAID BY ADDRESSEE

City and County of San Francisco
OFFICE OF CITIZEN COMPLAINTS
875 Stevenson Street, Room 125
San Francisco, CA 94103-0917

941030917 0001



22

NARRATIVE OF INCIDENT: ON 5-19-07 After 12:05 am i
was walking from 46th and the PII Great Hy AS i crossed the street
onto 47th towards 48th I found a bicycle about 150 feet from the corner of 47th
Looking around did not see noone i pick up the bike as i looked up black and
white coming down 48th towards 47th Northbound. As they passed me by we
looked at each other, they passed me up. They slammed on the brakes put
car in reverse they reverse to the corner of 48th. Officer Cravallo got out
with his gun drawn. Then Officer Morgado sped up to where i was
Already off the bike. Officer turned in to me not slowing down i
pushed the bike and jumped out of the with both arms in the air
yelling at the officer. While he leaned over and fired one shot at me.
The shot was so close to my face it skinned the bridge of my nose
leaving shrap metal in the bridge of my nose and striking my left index
finger bullet lodging into the roof of the van where i was standing
in front. Blood splattered thruout the side of the van. And blood
trail on the sidewalk. I drop down to take cover. Then he
fired a 2nd shot skinning my head. Bullet striking windshield
of van. That was directly behind me. I got up and ran and
they found me 4 hours later. Saying that i opened fire on them
and saying that officer Morgado stated he never shot at me.
Casings are gone removing crucial evidence to try to set me up.
there are so many more lies thruout my case from both officers
and more evidence being planted thruout. Charges been dropped
and refiled on a Grand Jury indictment.

(State law passed in 1995 mandates that the following statement be provided to, read and signed by persons filing complaints. The OCC encourages the filing of a complaint by anyone who believes he or she is a victim or a witness of improper police conduct or policies.)

ACKNOWLEDGEMENT OF COMPLAINANT (148.6 P.C.)

YOU HAVE THE RIGHT TO MAKE A COMPLAINT AGAINST A POLICE OFFICER FOR ANY IMPROPER POLICE CONDUCT. CALIFORNIA LAW REQUIRES THIS AGENCY TO HAVE A PROCEDURE TO INVESTIGATE CITIZENS' COMPLAINTS. YOU HAVE A RIGHT TO A WRITTEN DESCRIPTION OF THIS PROCEDURE. THIS AGENCY MAY FIND AFTER INVESTIGATION THAT THERE IS NOT ENOUGH EVIDENCE TO WARRANT ACTION ON YOUR COMPLAINT; EVEN IF THAT IS THE CASE, YOU HAVE THE RIGHT TO MAKE THE COMPLAINT AND HAVE IT INVESTIGATED IF YOU BELIEVE AN OFFICER BEHAVED IMPROPERLY. CITIZEN COMPLAINTS AND ANY REPORTS OR FINDINGS RELATING TO COMPLAINTS MUST BE RETAINED FOR AT LEAST FIVE YEARS. IT IS AGAINST THE LAW TO MAKE A COMPLAINT THAT YOU KNOW TO BE FALSE. IF YOU MAKE A COMPLAINT AGAINST AN OFFICER KNOWING THAT IT IS FALSE, YOU CAN BE PROSECUTED ON A MISDEMEANOR CHARGE.

I HAVE READ AND UNDERSTOOD THE ABOVE STATEMENT. THE ACKNOWLEDGMENT HAS BEEN READ TO THE COMPLAINANT.

Complainant Signature/Date: PII	Taken By (Name#/Unit)/Date: 8-5/08
Assigned Investigator/Date: D. M. Z. S. M. 8/18/08	Closure Approval/Date: PII 7/13/09

0662-08

OCC ALLEGATION CONTINUATION FORM

OCC CASE NO. 0662-08 COMPLAINTANT: [REDACTED] ID [REDACTED]

12 Activity	13 Type	14 DISP.	15 Uniform Yes No	16 Rank	17 Member's Name & Star Number	18 Unit	19 Svc	20 Sex	21 Eth
14	UF	PC	X	22	ID PENDING				
					Dennis Cravalho	3E	01	M	3
					#1783				

ALLEGATIONS: This is a complaint of:

UNNECESSARY FORCE (UF) - FOR DISCHARGING A WEAPON (ID PENDING)
of Dennis Cravalho #1783

OFFICE OF CITIZEN COMPLAINTS - USE BLACK INK ONLY!

1 Day, Date & Time Complaint Received
~~5-19-07~~ WED, AUG. 13, 2008
 Complaint Against: Personnel Policy Procedure
 How Received: Person Phone Letter SFPD Mail-In Other : (specify) N/A

ID [REDACTED]

2 Primary Complainant: Co-Complainant
 ID [REDACTED]
 Last Name First Name Middle Initial
 HOME ADDRESS: Homeless in
 Street Apartment
 PII PII
 City State Zip
 WORK ADDRESS: None
 Street Apartment
 None Homeless
 City State Zip

3 Personal Information
 Age: 52 Date of Birth: [REDACTED] PII
 Sex: M
 Ethnicity: HISPANIC
 Occupation: Painter

4 Telephone Numbers:
 Home: ()
 Work: ()

5 Location of Occurrence:
Lower Great Highway
 8 Day, Date, & Time Of Occurrence:
MAY 19 2007 (A.M.) P.M. 12:15
 (Circle one)

6 Type of Place Street 7 District I SUNSET
 9 Incident Report or Citation No
 ID [REDACTED]

10 SECONDARY COMPLAINANT? Yes No Witnesses? Yes No (If "Yes", attach separate sheet of paper.)
 Taped Interview? Yes No Criminal Case Pending in Relation to this matter? Yes No

11 Injuries Claimed? Yes No Injuries Visible? Yes No Drug/Alcohol Related? Yes No
 Photos Taken? Yes No By: Photo Lab O.C.C. Other: CSI
 Type of Injury: Dog bites, GUN shot Medical Release Signed? Yes No

12 Activity	13 Type	14 DISP.	15 Uniform Yes No	16 Rank	17 Member's Name & Star Number POBRA	18 Unit	19 Svc	20 Sex	21 Eth
Driver			<input checked="" type="checkbox"/>		[REDACTED]			M	W
Passenger			<input checked="" type="checkbox"/>		CRAVALHO 1783	SBI		M	W
SEE CONTINUATION FORMS									

POSTED 8/20/08

22

NARRATIVE OF INCIDENT:

ON - 5-19-07 After 12:05 am i was walking from 46th and the PII Great Hy. St. i crossed the street onto 47th towards 48th. I found a bicycle about 150 feet from the corner of 47th looking around did not see anyone i pick up the bike as i looked up black and white coming down 48th towards 47th Northbound. As they passed me by we looked at each other, they passed me up. They slammed on the brakes put car in reverse they reverse to the corner of 48th. Officer Cravalls got out with his gun drawn. Then Officer Morgado sped up to where i was already off the bike. Officer turned in to me not slowing down i pushed the bike and jumped out of the with both arms in the air yelling at the officer. While he leaned over and fired one shot at me. The shot was so close to my face it skinned the bridge of my nose leaving Shrap metal in the bridge of my nose and striking my left index finger bullet lodging into the roof of the van where i was standing in front. Blood splattered thruout the side of the van. And blood trail on the sidewalk. I drop down to take cover. Then he fired a 2nd shot skinning my head. Bullet striking windshield of van that was directly behind me. I get up and ran and they found me 4 hours later. Saying that i opened fire on them and saying that officer Morgado stated he never shot at me. Casings are gone removing crucial evidence to try to set me up. there are so many more lies thruout my case from both officers and more evidence being planted thruout. Charges been bropped and refiled on a Grand Jury indictment.

(State law passed in 1995 mandates that the following statement be provided to, read and signed by persons filing complaints. The OCC encourages the filing of a complaint by anyone who believes he or she is a victim or a witness of improper police conduct or policies.)

ACKNOWLEDGEMENT OF COMPLAINANT (148.6 P.C.)

YOU HAVE THE RIGHT TO MAKE A COMPLAINT AGAINST A POLICE OFFICER FOR ANY IMPROPER POLICE CONDUCT. CALIFORNIA LAW REQUIRES THIS AGENCY TO HAVE A PROCEDURE TO INVESTIGATE CITIZENS' COMPLAINTS. YOU HAVE A RIGHT TO A WRITTEN DESCRIPTION OF THIS PROCEDURE. THIS AGENCY MAY FIND AFTER INVESTIGATION THAT THERE IS NOT ENOUGH EVIDENCE TO WARRANT ACTION ON YOUR COMPLAINT; EVEN IF THAT IS THE CASE, YOU HAVE THE RIGHT TO MAKE THE COMPLAINT AND HAVE IT INVESTIGATED IF YOU BELIEVE AN OFFICER BEHAVED IMPROPERLY. CITIZEN COMPLAINTS AND ANY REPORTS OR FINDINGS RELATING TO COMPLAINTS MUST BE RETAINED FOR AT LEAST FIVE YEARS. IT IS AGAINST THE LAW TO MAKE A COMPLAINT THAT YOU KNOW TO BE FALSE. IF YOU MAKE A COMPLAINT AGAINST AN OFFICER KNOWING THAT IT IS FALSE, YOU CAN BE PROSECUTED ON A MISDEMEANOR CHARGE.

I HAVE READ AND UNDERSTOOD THE ABOVE STATEMENT.

THE ACKNOWLEDGMENT HAS BEEN READ TO THE COMPLAINANT.

Complainant Signature/Date:

Taken By (Name#/Unit)/Date:

Assigned Investigator/Date:

Closure Approval/Date:

PII

8-15/08

OCC ALLEGATION CONTINUATION FORM

OCC CASE NO. 0662-08 COMPLAINTANT: [REDACTED] ID

12	13	14	15		16	17	18	19	20	21	
Activity	Type	DISP.	Uniform	Yes	No	Rank	Member's Name & Star Number	Unit	Svc	Sex	Eth
14	UF						ID PENDING				

ALLEGATIONS: This is a complaint of:

UNNECESSARY FORCE (UF) - FOR DISCHARGING A WEAPON (ID PENDING)

**OFFICE OF CITIZEN COMPLAINTS
COMPLAINT SUMMARY REPORT**

OCC Case No: 0662-08

DATE OF COMPLAINT: 08/18/2008 **DATE OF COMPLETION:** **PAGE#** 1 of 1

Officer: Dennis Cravalho #1783

SUMMARY OF ALLEGATION #1: The officer discharged a weapon at the complainant without cause.

CATEGORY OF CONDUCT: UF **FINDING** **PC** **DEPT.** **ACTION:**

FINDINGS OF FACT: The complainant stated the officers fired at him for no reason. the investigation proved the officer fired when the complainant fired upon the patrol car and turned the weapon on the officer. The officer's conduct was lawful, proper, an necessary .

SUMMARY OF ALLEGATION #2:

CATEGORY OF CONDUCT: **FINDING:** **DEPT. ACTION:**

FINDINGS OF FACT:

**OFFICE OF CITIZEN COMPLAINTS
COMPLAINT SUMMARY REPORT**

DATE OF COMPLAINT: 08/18/2008 **DATE OF COMPLETION:** 07/13/09 **PAGE#** 1 of 1

SUMMARY OF ALLEGATION #1: The officer discharged a weapon at the complainant without cause.

CATEGORY OF CONDUCT: UF **FINDING** PC **DEPT.** **ACTION:**

FINDINGS OF FACT: The complainant stated the officers fired at him for no reason. The investigation proved the officer fired when the complainant fired upon the patrol car and turned the weapon on the officer. The officer's conduct was lawful, proper, and necessary .

SUMMARY OF ALLEGATION:

CATEGORY OF CONDUCT: **FINDING:** **DEPT. ACTION:**

FINDINGS OF FACT:

OFFICE OF CITIZEN COMPLAINTS

WITNESS LIST

OCC CASE NO. 668-08

Civilian Officer
Name: Dennis Cranley
Address: #1783
City: _____
State: _____ Zip: _____
Telephone: _____

Civilian Officer
Name: _____
Address: _____
City: _____
State: _____ Zip: _____
Telephone: _____

Civilian Officer
Name: _____
Address: _____
City: _____
State: _____ Zip: _____
Telephone: _____

Civilian Officer
Name: _____
Address: _____
City: _____
State: _____ Zip: _____
Telephone: _____

Civilian Officer
Name: _____
Address: _____
City: _____
State: _____ Zip: _____
Telephone: _____

Civilian Officer
Name: _____
Address: _____
City: _____
State: _____ Zip: _____
Telephone: _____

Civilian Officer
Name: _____
Address: _____
City: _____
State: _____ Zip: _____
Telephone: _____

Civilian Officer
Name: _____
Address: _____
City: _____
State: _____ Zip: _____
Telephone: _____

Civilian Officer
Name: _____
Address: _____
City: _____
State: _____ Zip: _____
Telephone: _____

Civilian Officer
Name: _____
Address: _____
City: _____
State: _____ Zip: _____
Telephone: _____

Case No. 668-08
 Investigator MAte
 Page 1 of

OCC TAPED INTERVIEW LOG

Date of Interview	Name of Interviewee or subject of tape (e.g. CAD tape)	Comments
5/18/09	Off. Cranley #1783	

Date submitted to file room

Total Number of Tapes

INTAKE CHECKLIST

CASE # 688-08

COMPLAINANT [REDACTED] ID [REDACTED]

PHASE I (first ten days)

	Done	N/A	Date Ordered and Notes
A. CASE RECEIVED	✓		8/19/08
1. Log into book/database			
B. LOCATE AND INTERVIEW COMPLAINANT			
1. Obtain specific contact info			
2. Medical release signed			
3. Juvenile Consent form signed			
4. 148.6 signed or taped			
5. Photograph injuries			
6. Photo spread			
7. Complete 293	✓		8/12/08
C. CASE CHRONOLOGY			
1. Summarize interviews/evidence in CWS			
2. Record investigative steps in CWS			
D. COMPUTER INFORMATION			
1. Run CAD, QCH, QUH,	✓		8/19/08
2. DMV, QALL, QIR, QPRL, QLAB, QCA			
3. Run PS or Roster			
4. Other _____			
E. ORDER DOCUMENTS			
1. Obtain copy of IR	✓		
2. Obtain communications tape			
3. Citations ordered			
4. Medical records			
5. Arrest card			
6. S/W (affidavit), UOF log, Tow Inventory,			
7. 849(b), Strip Search Auth., Juvenile Log, Arrest			
8. Log, Paramedic Records			
9. Housing card			
10. Other <u>Domestic Manuals</u>	✓		8/15/08
F. IDENTIFY WITNESSES			
1. Obtain specific contact info			
2. Start witness list			
G. DRAFT ALLEGATIONS	✓		
H. FINALIZE NARRATIVE	✓		
I. START TAPED INTERVIEW LOG	✓		
J. REVIEW GO'S, RULES, HS/WI/PC/DB/MPC/ COPWARE	✓		
K. PREPARE CASE MGMNT. DOC. (See reverse)	✓		

PHASE II

	Done	N/A	Date Done/ Notes
A. SENT IN FOR INTAKE REVIEW	✓		
B. INV PLAN/ALLEGATIONS APPROVED	✓		
C. ASSIGN WEIGHT	✓		
D. COPY 293	✓		
1. Copies sent to Admin	✓		
2. Copies mailed to COMP	✓		

(OVER)

CASE MANAGEMENT DOCUMENT

	Priority	Weight	Initials	Date
Investigator	_____	_____	_____	_____
Sr. Investigator	_____	_____	_____	_____
Chief Investigator	<u>B</u>	<u>3</u>	<u>CRG</u>	<u>7/13/09</u>
Upon Closure	_____	_____	_____	_____
Due Date	_____			

Investigative Plan/Comments/Suggestions/Request for Conference:

Report Type: Initial

San Francisco Police Department INCIDENT REPORT

ID

Incident Number ID	Occurrence from Date/Time 05/19/07 01:00	Occurrence to Date/Time	Reported Date/Time 05/19/07 01:02	CAD Number ID	ID
Type of Incident Assault, Att. Homicide, W/ Gun -04021, Assault, Aggravated, On Police Officer, W/ Gun -04071A, Firearm, Possession By Prohibited Person -12080					
Location of Occurrence PII GREAT HIGHWAY			At Intersection with/Premise type Apartment		
Confidential Report? <input type="checkbox"/>	Arrest Made? <input checked="" type="checkbox"/>	Suspect Known? <input type="checkbox"/>	Suspect Unknown? <input type="checkbox"/>	Non-Suspect Incident? <input type="checkbox"/>	Domestic Violence? <input type="checkbox"/> (Type of Weapon Used)
Reporting Unit 3113E					
Location Sent 48TH/TARAVAL St					
How Cleared? 6	Reported to Bureau Operations Center	Name CONTRERAS	Star 1082	Date/ Time 05/19/07 01:09	Elder Victim <input type="checkbox"/>
					Gang Related? <input type="checkbox"/>
					Juvenile Subject? <input type="checkbox"/>
					Prejudice Based? <input type="checkbox"/>

D E C L A R A T I O N

I declare under penalty of perjury, this report of 7 pages is true and correct, based on my personal knowledge, or is based on information and belief following an investigation of the events and parties involved.

PROP 115 CERTIFIED POST TRAINING Signature: PII

Reporting Officer Palma, Michael A.	Star 841	Station Taraval Station	Watch 2100-0700	Date 05/19/07 14:21:40
Reviewing Officer Sgt Sfr	STAR 692	Station C01	Watch 21-07	Date 05/19-07
OIC Daniel L. O'Leary Lieutenant SFPD/1059	STAR	Station TARAVAL	Watch 0500-1500	Date MAY 19 2007 / 1440
Related Case	Related Case	Re-Assigned to HOMI	Assigned by MP,841	
Copies to 5G200 5G200 5G200		Add'l Copies GW,BURGLARY		

R / N I T N E S S

Code RW 1	Name (Last, First Middle) ID	Alias
Day Phone PII	Type Home	Home Address PII
		City PII
		State PII
		Zip Code PII
Night Phone PII	Type Work	Work Address PII
		City PII
		State PII
		Zip Code
DOB / Age PII	DOB Unk. <input type="checkbox"/>	or age between: and
	Race W	Sex M
	Height	Weight
	Hair Color	Eye Color
	ID Type	Jurisd. ID No.
Confidential Person <input type="checkbox"/>	Violent Crime Notification <input type="checkbox"/>	293/PC Notification <input type="checkbox"/>
	Star	Follow-up Form YES <input checked="" type="checkbox"/>
		Statement YES <input checked="" type="checkbox"/>
		Relationship to Subject Stranger/None
School (if Juvenile)	Injury/Treatment	Other Information/If Interpreter Needed Specify Language CELL # PII

B O O K E D

Code B 1	Name (Last, First Middle) ID	ALI.AS
Day Phone	Type	Home Address NO LOCAL
		City
		State
		Zip Code
Night Phone	Type	Work Address
		City
		State
		Zip Code
DOB Unknown <input type="checkbox"/>	Date of Birth PII	Age 50
		or age between and
	Race H	Sex M
	Height 5'07	Weight 145
	Hair Color BLK	Eye Color BRO
SFNO	J/D# (if Juvi.)	ID Type/Jurisdiction/Number
		ID Type/Jurisdiction/Number
		ID Type/Jurisdiction/Number
Book Section #1 N/W 664/187PC	Book Section #2 N/W 664/187PC	Book Section #3 N/W459 PC
Book Section #4 N/W 12021(A)PC	Book Section #5 N/W245(d)-2cts	Booking Location SFSO County Jail #9
Warrant #	Court #	Action #
		Dept
		Enroute to
		CWB Check
		Star
Warrant Violation(s)	Bail	Mirandized <input type="checkbox"/>
		Star
		Date
		Time
		Statement <input type="checkbox"/>
Citation #	Violation(s)	Appear Date/Time
		Location of Appearance
Book/Cite Approval INSP GAINOR	Star 1524	Mass Arrest Code
		M X-Rays <input type="checkbox"/>
		School (if Juvenile)
		<input type="checkbox"/> CA Form Booked Copy Attached

Other Information: Citation/Warrant/Booking Charge(s)/Missing Person-Subject Description; Scars, Marks, Tattoos

WEARING BLACK BALL CAP, BLACK JACKET, BLUE PANTS

SFDPA - 0662-08 - 000017

Printed by Automated System on 05/19/07 14:40:00

San Francisco Police Department
ADDITIONAL REPORTEE

RP CODES: F -FOUND; N -NOTIFY;P -PARENT; R -REPORTEE; V -VICTIM; W -WITNESS

R / V I C T I M	Code R/V 1	Name (Last, First Middle) ID				Alias				
	Day Phone PII	Type Home	Home Address PII			City PII	State PII	Zip Code PII		
	Night Phone PII	Type Cell	Work Address PII			City PII	State PII	Zip Code PII		
	DOB/ Age PII	DOB Unk <input type="checkbox"/>	or age between AND	Race W	Sex M	Height	Weight	Hair Color	Eye Color	ID No.
	Confidential Person <input type="checkbox"/>	Violent Crime Notification <input type="checkbox"/>	293 PC Notification <input type="checkbox"/>	Star	F/U Form YES <input checked="" type="checkbox"/>	Statement YES <input checked="" type="checkbox"/>	Relationship to Subject Unknown			
	School (if Juvenile)		Injury/Treatment			Other Information/If Interpreter Needed Specify Language				

R / W I T N E S S	Code R/W 2	Name (Last, First Middle) ID				ALIAS				
	Day Phone PII	Type Home	Home Address PII			City PII	State PII	Zip Code PII		
	Night Phone PII	Type Work	Work Address PII			City PII	State PII	Zip Code		
	DOB/ Age	DOB Unk <input type="checkbox"/>	or age between AND	Race	Sex	Height	Weight	Hair Color	Eye Color	ID No.
	Confidential Person <input type="checkbox"/>	Violent Crime Notification <input type="checkbox"/>	293 PC Notification <input type="checkbox"/>	Star	F/U Form YES <input type="checkbox"/>	Statement YES <input type="checkbox"/>	Relationship to Subject			
	School (if Juvenile)		Injury/Treatment			Other Information/If Interpreter Needed Specify Language				

Code	Name (Last, First Middle)				ALIAS				
Day Phone	Type	Home Address			City	State	Zip Code		
Night Phone	Type	Work Address			City	State	Zip Code		
DOB/ Age	DOB Unk <input type="checkbox"/>	or age between AND	Race	Sex	Height	Weight	Hair Color	Eye Color	ID No.
Confidential Person <input type="checkbox"/>	Violent Crime Notification <input type="checkbox"/>	293 PC Notification <input type="checkbox"/>	Star	F/U Form YES <input type="checkbox"/>	Statement YES <input type="checkbox"/>	Relationship to Subject			
School (if Juvenile)		Injury/Treatment			Other Information/If Interpreter Needed Specify Language				

Code	Name (Last, First Middle)				Alias				
Day Phone	Type	Work Address			City	State	Zip Code		
Night Phone	Type	WORK ADDRESS			City	State	Zip Code		
DOB/ Age	DOB Unk <input type="checkbox"/>	or age between AND	Race	Sex	Height	Weight	Hair Color	Eye Color	ID No.
Confidential Person <input type="checkbox"/>	Violent Crime Notification <input type="checkbox"/>	293 PC Notification <input type="checkbox"/>	Star	F/U Form YES <input type="checkbox"/>	Statement YES <input type="checkbox"/>	Relationship to Subject			
School (if Juvenile)		Injury/Treatment			Other Information/If Interpreter Needed Specify Language				

SFPD377 B (03/03)

ADDITIONAL RECORDS

ADDITIONAL SUSPECTS

ID [REDACTED]

SUSPECT 1	CODE S 1	Name (Last, First Middle) UNKNOWN ,(Unknown First Name)				Alias				
	Day Phone	Type	Home Address UNKNOWN			City		State	Zip Code	
	Night Phone	Type	Work Address			City		State	Zip Code	
	School (if Juvenile)		Race W	Sex M	DOB Unknown <input type="checkbox"/>	DOB	Height	Weight	Hair Color BLD	Eye Color UNK
	SFNO	J/D# (if Juv.)	ID No.		ID No.		ID No.			
	Book/Charge 1	Book/Charge 2	Book/Charge 3	Book/Charge 4	Book/Charge 5	Where Booked				
	Warrant #	Court #	Action #	Dept	Enroute To		CWB Check	Star		
	Warrant Violation(s)				Bail	Mirandized <input type="checkbox"/>	Star	Date/Time	Statement <input type="checkbox"/>	
	Citation #	Violation(s)			Appear Date/Time		Location of Appearance			
	Book/Cite Approval	Star	Mass Arrest Code	M X-Rays <input type="checkbox"/>						

Other Information: Citation/Warrant/Booking Charge(s)/Missing Persons-Subject Description/Scars, Marks, Tatoos
5'08-6'0" TALL. MEDIUM BUILD.LIGHT HAIR BLONDE OR STRAWBERY BLONDE.UNKNOWN CLOTHING

PVT PERSON ARREST	<input type="checkbox"/> ORIGINAL PRIVATE PERSON'S ARREST FORM BOOKED AS EVIDENCE. PHOTOCOPY ATTACHED WITH THIS REPORT.
--------------------------	---

RECORDS	CODE	Name (Last, First Middle)				Alias				
	Day Phone	Type	Home Address			City		State	Zip Code	
	Night Phone	Type	Work Address			City		State	Zip Code	
	School (if Juvenile)		Race	Sex	DOB Unknown <input type="checkbox"/>	DOB	Height	Weight	Hair Color	Eye Color
	SFNO	J/D# (if Juv.)	ID No.		ID No.		ID No.			
	Book/Charge 1	Book/Charge 2	Book/Charge 3	Book/Charge 4	Book/Charge 5	Where Booked				
	Warrant #	Court #	Action #	Dept	Enroute To		CWB Check	Star		
	Warrant Violation(s)				Bail	Mirandized <input type="checkbox"/>	Star	Date/Time	Statement <input type="checkbox"/>	
	Citation #	Violation(s)			Appear Date/Time		Location of Appearance			
	Book/Cite Approval	Star	Mass Arrest Code	M X-Rays <input type="checkbox"/>						

Other Information: Citation/Warrant/Booking Charge(s)/Missing Persons-Subject Description/Scars, Marks, Tatoos

PVT PERSON ARREST	<input type="checkbox"/> ORIGINAL PRIVATE PERSON'S ARREST FORM BOOKED AS EVIDENCE. PHOTOCOPY ATTACHED WITH THIS REPORT.
--------------------------	---

ID

San Francisco Police Department PROPERTY LISTINGS

E 1	Code/No EVD 1	Item Description WRITTEN STATEMENT				Brand	Model	
	Serial No.	Gun Make	Caliber	Color WHI	Narcotics Lab No.	Quantity 2	Value	
	Seized by (Star) 897	From Where PII GREAT HIGHWAY						
	Additional Description/Identifying Numbers WRITTEN BY RW [REDACTED]							
E 2	Code/No EVD 2	Item Description SFPD COLD SHOW ADMONITION				Brand	Model	
	Serial No.	Gun Make	Caliber	Color WHI	Narcotics Lab No.	Quantity 1	Value	
	Seized by (Star) 974	From Where GREAT HIGHWAY/SANTIAGO						
	Additional Description/Identifying Numbers SIGNED BY RW [REDACTED] ID [REDACTED]							
E 3	Code/No EVD 3	Item Description CRIME SCENE LOGS				Brand	Model	
	Serial No.	Gun Make	Caliber	Color	Narcotics Lab No.	Quantity 4	Value	
	Seized by (Star) 841	From Where SCENE						
	Additional Description/Identifying Numbers							
E 4	Code/No EVD 4	Item Description WRITTEN STATEMENT				Brand	Model	
	Serial No.	Gun Make	Caliber	Color	Narcotics Lab No.	Quantity 1	Value	
	Seized by (Star) 841	From Where OFFICER PERA#958						
	Additional Description/Identifying Numbers WRITTEN BY SFPD OFFICER PERA #958							
E 5	Code/No EVD 5	Item Description WRITTEN STATEMENT				Brand	Model	
	Serial No.	Gun Make	Caliber	Color WHI	Narcotics Lab No.	Quantity 2	Value	
	Seized by (Star) 841	From Where SGT. LALOR #873						
	Additional Description/Identifying Numbers							
S 7 R 1	Code/No SAR 1	Item Description BIKE				Brand GARY FISCHER	Model	
	Serial No. UNKNOWN	Gun Make	Caliber	Color GRN	Narcotics Lab No.	Quantity 1	Value 1200.00	
	Seized by (Star)	From Where 48TH/TARAVAL						
	Additional Description/Identifying Numbers SEIZED BY CSI							
E 6	Code/No EVD 6	Item Description PHOTODISK				Brand	Model	
	Serial No.	Gun Make	Caliber	Color BLK	Narcotics Lab No.	Quantity 1	Value	
	Seized by (Star) 1886	From Where 48TH/TARAVAL						
	Additional Description/Identifying Numbers 15 photos taken of vehicle and area of vehicle.							

SFDP - 0662-08 - 000020

Incident# [REDACTED]

ID [REDACTED]

Page 4 of 7

ID

San Francisco Police Department PROPERTY LISTINGS

E 7	Code/No EVD 7	Item Description WRITTEN STATEMENT				Brand	Model	
	Serial No.	Gun Make	Caliber	Color	Narcotics Lab No.	Quantity 1	Value	
	Seized by (Star) 841	From Where Officer Chan #1886						
	Additional Description/Identifying Numbers							
	Code/No	Item Description				Brand	Model	
	Serial No.	Gun Make	Caliber	Color	Narcotics Lab No.	Quantity	Value	
	Seized by (Star)	From Where						
	Additional Description/Identifying Numbers							
	Code/No	Item Description				Brand	Model	
	Serial No.	Gun Make	Caliber	Color	Narcotics Lab No.	Quantity	Value	
	Seized by (Star)	From Where						
	Additional Description/Identifying Numbers							
	Code/No	Item Description				Brand	Model	
	Serial No.	Gun Make	Caliber	Color	Narcotics Lab No.	Quantity	Value	
	Seized by (Star)	From Where						
	Additional Description/Identifying Numbers							
	Code/No	Item Description				Brand	Model	
	Serial No.	Gun Make	Caliber	Color	Narcotics Lab No.	Quantity	Value	
	Seized by (Star)	From Where						
	Additional Description/Identifying Numbers							
	Code/No	Item Description				Brand	Model	
	Serial No.	Gun Make	Caliber	Color	Narcotics Lab No.	Quantity	Value	
	Seized by (Star)	From Where						
	Additional Description/Identifying Numbers							

RECORDS SECTION

SFDPA - 0662-08 - 000021

Incident#

ID

San Francisco Police Department
NARRATIVE

ID [REDACTED]

Additional Type of Incident: N/W 459 PC, N/W 496 (a), N/W 12031 (a) (1), N/W 12025(a) (2) PC.

On the above date and time Officer Higa #1295 and I were dispatched to [REDACTED] PII Great Highway regarding a call of a burglary. 3116E SFPD Officers Cravalho # 1783 and Morgado #466 also responded and were the first unit to arrive on scene. Prior to our arrival, Officers Cravalho and Morgado advised dispatch that shots had been fired upon them at 48th and Taraval St. Officers Cravalho and Morgado advised dispatch that a male in a black jacket "opened fire" on them and he was running up Taraval Street.

Upon arrival, Officer Higa and I observed Officer Cravalho running eastbound on Taraval Street. Officer Cravalho stated "Be careful the guy in the black jacket just shot at us, he is running eastbound on Taraval Street at 47th Avenue." Officer Higa and I responded to Taraval St. and 47th Avenue in our marked police vehicle. I observed a male wearing a black jacket and black ball cap running northbound on 47th Avenue. The suspect began walking on the west side of the street in between the parked vehicles and I then lost sight of him.

Officer Cravalho and Morgado told me the following: Officer Morgado and Cravalho were driving northbound on 48th Avenue when they observed a subject on a bike that may have been responsible for the burglary. Officer Cravalho exited the marked patrol vehicle to detain the suspect. Officer Morgado being the driver tried to catch the suspect on the bike with the patrol vehicle. As Officer Morgado drove the vehicle towards the suspect, the suspect then pulled a gun from his waistband and began shooting at Officer Morgado. Officer Cravalho observed the suspect shooting at Officer Morgado. Fearing for his own and Officer Morgado's life, Officer Cravalho began to return fire at the suspect with his department issued firearm. The suspect then turned and began to fire his handgun at Officer Cravalho. After Officer Cravalho and the suspect stopped shooting, the suspect fled eastbound on Taraval Street towards 47th Ave.

Numerous SFPD Officers throughout the city responded (CAD# [REDACTED] ID) and a perimeter was established. Contreras #1082 at Operations was notified at 0109 hours and a command post was established at 47th and Taraval Street. SFPD Specialists and Tactical Units arrived onscene and assisted in the operation.

Sgt Kato #692 established a Command Post.

Officers Cravalho and Morgado were transported to SFGH by Medic 18 for their injuries they sustained during the incident. Officers Higa and Palma responded with Medic 18 to SFGH.

3X301, Captain Tittel #2104 arrived onscene at 0110 hours. 4T300 Captain Mcdonagh #377 arrived onscene and established tactical command. Captain Sanford #1414 was notified of the incident and responded to the scene.

Officer Higa and I responded to [REDACTED] PII Great Highway to meet with (R/W1) [REDACTED] ID and (R/V1) [REDACTED] ID. [REDACTED] ID told me the following: [REDACTED] ID exited his condo to walk his dog and he noticed his garage door open. [REDACTED] ID observed a male pulling up the garage door from the inside of the garage. An (S1) unidentified individual rode a (S/R) bike out of the garage and continued southbound on Great Highway. The other male in the garage, later identified as (B1) [REDACTED] ID stated "I wasn't in your garage," and walked south on Great Highway. [REDACTED] ID called his [REDACTED] PII from the lobby and told her to call the police and she did immediately. [REDACTED] ID then followed (B1) [REDACTED] ID on foot until the area of 47th and Santiago and then heard what he thought were fire crackers and voices

SFDPA - 0662-08 - 000022

RECORDED BY ALI@STATION 06 SEP 13 2009 09:26:49 AM

shouting. [REDACTED] then walked back home. [REDACTED] provided SGT Dare #897 with an (E1) written statement prior to my arrival. I provided [REDACTED] with a follow-up form with a case number.

Officer Higa talked to (R/V) [REDACTED] and he told Officer Higa the following: The (S/R) bike was last seen at 5-18-07 at 2300 hours and was stored in the garage. This was the (S/R) bike that [REDACTED] observed the suspect riding out of the garage with and onto the Great Highway. The bike was later recovered at 48th/ Taraval Street. [REDACTED] was provided a follow-up form with a case number. [REDACTED] was asleep during the incident and did not see or hear anything.

Insp. Gainor #1524 and Insp. Philpott #65 arrived and took charge of the investigation.

I determined the possible point of entry and exit was the garage door. [REDACTED] and [REDACTED] did not give anyone permission to enter and or to take their property.

While conducting our interview with [REDACTED] and [REDACTED] the Tactical and Specialist Units located (B1) [REDACTED] hidden in a bush at Santiago and Great Highway. See (E4), (E5) Statements provided by Officer Pera #958 and Sgt. Lalor #873 regarding the above listed incident. Sgt. Lalor entered the use of force in the log and notified Sgt. Kato.

A cold show was conducted and suspect [REDACTED] was positively identified by [REDACTED] as the person who was in his garage. An (E2) SFPD Cold Show Admonition was completed by Officer Rouede #974 and signed by [REDACTED].

[REDACTED] was later transported to SFGH by Medic #19 for injuries he sustained, with Officers Oshita #4112 and Guardado #395. (S1) was not located despite an intensive search. [REDACTED] was treated by attending physician [REDACTED] at SFGH.

The five separate crime scenes were established and maintained by SFPD Officers. (See attached Crime Scene Logs.) The integrity of the scene was preserved until Inspectors Gregory #986, Gee #574 of CSI responded to process the scene. All evidence was collected and booked by CSI.

While at the command post Officer Apodaca #303 interviewed (R/W2) [REDACTED] and [REDACTED] told Officer Apodaca the following: [REDACTED] was in front of his house and heard gun shots. [REDACTED] observed a male in a black jacket walking fast eastbound on Taraval Street to 47th Avenue.

Officer Chan #1886 took (E6) 15 photos of the damage to SFPD vehicle #531 at 48th/Taraval. The (E6) photos were booked at Taraval Station as evidence. Officer Chan provided me with a (E7) written statement.

(B1) [REDACTED] was booked accordingly at CJ#9 on the above listed charges with the approval of Insp. Gainor # 1524

Printed by ALLEGATION on Sep 11, 2008 at 08:10:10
AUDIT RECORDS

INCIDENT REPORT STATEMENT

page 1 of 2

SAN FRANCISCO POLICE DEPARTMENT

INCIDENT NO. [REDACTED] ID [REDACTED]

NAME (LAST, FIRST, MIDDLE) OF PERSON GIVING STATEMENT [REDACTED] DOB / AGE [REDACTED] PII RESIDENCE PHONE (DAY / NIGHT) [REDACTED] PII BUSINESS PHONE (DAY/NIGHT) [REDACTED] PII

RESIDENCE ADDRESS / CITY IF NOT SAN FRANCISCO [REDACTED] PII ZIP CODE [REDACTED] PII BUSINESS ADDRESS / CITY IF NOT SAN FRANCISCO [REDACTED] PII ZIP CODE [REDACTED]

DATE OF STATEMENT 5/19/07 TIME STARTED 0304 TIME COMPLETED 0329 LOCATION WHERE STATEMENT TAKEN AT SCENE OTHER:

STATEMENT TAKEN BY (NAME / STAR) SGT. DARE #97 IN PRESENCE OF SGT. DAVIECE 93 #96-6000 - noc.

At approximately 1:00 am, I exited my condo ~~to~~ to walk the dog. As I was standing on the sidewalk about to cross the street I noticed that my garage door was opening. Earlier in the night at approximately 11:00 pm, the garage doors were not operating. As the garage door was opening I observed a male pulling up the garage door from the inside. As the door reached about halfway open an individual rode a bike out of the garage. Both of the individuals were white males. The individual on the bike rode past me and headed south on the great highway. I asked "what are you doing in my garage". The individual on the bike said nothing and rode away. The individual who was on foot walked out of the garage and started south on the great highway. I asked again "what are you doing in my garage". He said "I wasn't in your garage" and walked away south on the great highway. The person on the bike was of medium size with light hair - maybe dirty blond or strawberry blond hair. Clothes were non-descript. The individual

Audit Records

I DECLARE, UNDER PENALTY OF PERJURY, THIS STATEMENT OF [REDACTED] PII PAGES IS TRUE AND CORRECT, BASED ON MY PERSONAL KNOWLEDGE. 5/19/07

SIGNATURE OF PERSON GIVING STATEMENT [REDACTED] SFDPA - 0662-08 - 000024

INCIDENT NO. [REDACTED]		ID [REDACTED]	DOB / AGE [REDACTED] PII	RESIDENCE PHONE (DAY / NIGHT) ()	BUSINESS PHONE (DAY/NIGHT) ()
NAME (LAST, FIRST, MIDDLE) OF PERSON GIVING STATEMENT [REDACTED] ID [REDACTED]			ZIP CODE [REDACTED] PII	BUSINESS ADDRESS / CITY IF NOT SAN FRANCISCO [REDACTED] ZIP CODE [REDACTED]	
RESIDENCE ADDRESS (CITY & STREET) [REDACTED] PII	DATE OF STATEMENT 5/19/07	TIME STARTED	TIME COMPLETED	LOCATION WHERE STATEMENT TAKEN	
STATEMENT TAKEN BY (NAME / STAR)	IN PRESENCE OF		AT SCENE <input type="checkbox"/> OTHER:		

who was walking had dark hair, somewhat long and possibly having some facial hair on his chin. he was approximately 5'10" - medium (170-180) build. I asked my [REDACTED] PII to call the police via the building inter-com. I then followed the walking individual at a distance of approximately one block. he turned east on Rivera - walked up to 47th and turned south on 47th. At one point it appeared that he was talking on a cell phone. I followed behind until Santiago when I heard what I thought were fire crackers going off. There were some shouting voices as well. At that point I walked back to the Great Highway and returned home. The age of the individuals appeared to be in the early twenties. When I returned I was informed that my [REDACTED] PII had come down stairs and saw a black male carrying a gas can which he then left by the side of the building and walked away. he was wearing a knit cap faded blue clothes approximately 5'10". The clothes

I DECLARE, UNDER PENALTY OF PERJURY, THIS STATEMENT OF [REDACTED] PAGES IS TRUE AND CORRECT, BASED ON MY PERSONAL KNOWLEDGE.

SIGNATURE OF PERSON GIVING STATEMENT [REDACTED] were somewhat baggy so weight was hard to determine. [REDACTED] PII

0462-08-000025
5/19/07

ADULT RECORDS

INCIDENT REPORT STATEMENT

page 1 of 2

SAN FRANCISCO POLICE DEPARTMENT

INCIDENT NO.

[REDACTED] ID		DOB/AGE	RESIDENCE PHONE (DAY / NIGHT)	BUSINESS PHONE (DAY/NIGHT)
NAME (LAST, FIRST, MIDDLE) OF PERSON GIVING STATEMENT				
SGT. LALOR #873				
RESIDENCE ADDRESS / CITY IF NOT SAN FRANCISCO		ZIP CODE	BUSINESS ADDRESS / CITY IF NOT SAN FRANCISCO	
RESIDENCE ADDRESS / CITY IF NOT SAN FRANCISCO		ZIP CODE	BUSINESS ADDRESS / CITY IF NOT SAN FRANCISCO	
DATE OF STATEMENT	TIME STARTED	TIME COMPLETED	LOCATION WHERE STATEMENT TAKEN	
5/19/07	700 HRS	HRS	AT SCENE <input type="checkbox"/> OTHER: E	
STATEMENT TAKEN BY (NAME / STAR)		IN PRESENCE OF		

I was contacted by Officer Pera (by phone) concerning an Officer involved shooting in the Taraval District. I was told that the suspect had shot at the Officers, they returned fire and the suspect fled. Station units were setting up a perimeter with numerous members of the Specialist Team and Tactical Team responding. I responded to the scene. A helicopter was requested but was not available from any outside agencies. San Francisco PD no longer has an Air Unit to assist its Officers.

I arrived on scene and assumed tactical command, I was provided with a briefing concerning the incident. 3x301 Capt Tittle was on scene, I spoke to A/Sgt. Smith and we developed a plan to sweep the last known direction of the suspect- N/B 47 Th Ave from Tarava'. I then received information from Sgt. Burke that a blood trail was found at [REDACTED] PII 47 Th Ave leading up the stairs. A station unit had locked down the rear of the home and discovered the back door was kicked open. An interview with the neighbor revealed that the resident: [REDACTED] ID was on vacation and the rear door should be closed /locked.

A skirmish line was established and a protective sweep of the [REDACTED] PII block of 47 Th Ave was conducted. A new perimeter was established around [REDACTED] PII 47 Th Ave. A plan was developed and 3X301 Capt Tittle was briefed. Due to the blood trail leading to the house, the open rear door, and the need to conduct a well being check on the resident, [REDACTED] PII, the well being of the possible wounded suspect an entry into the home was authorized. Lt. Cota and Captain McDonagh arrived on scene and took over tactical command. Prior to the entry, Sgt. Burke and I knocked on the front door and then used a bullhorn to call out to anyone inside of the home. We did not receive a response. Members of the tactical unit along with Officer Byrne and K-9 "Roddy" conducted the search with negative results. The blood trail led N/B 47 Th Ave to Santiago and I had observed a blood mark on the corner wall.. No items were damaged during the search and Co I Officers secured the house. The back door had not been forced open just left unlocked.

The area of Santiago Street was searched for evidence, We then cleared S/B 48 Th Ave. A request was then made to search the lower Great Highway, upper Highway and the beach area. Teams were deployed to handle the searches. Sgt. Burke contacted me; he told me that he discovered a suspect hiding in the bushes on the lower Great Highway near Santiago. He then requested additional units as the suspect was failing to comply with his orders. A K-9 unit was request and an Officer with ERIW also responded. I arrived on scene from my beach location to hear numerous officers giving the suspect verbal commands. I used a car P.A. system to broadcast my orders for B- [REDACTED] ID to surrender or a K-9 unit would be deployed. I could tell that the suspect was not complying and did not see him appear from the bush area. I authorized Officer Byrne to release his K-9 "Roddy" to effect the arrest/detention of B- [REDACTED] ID. The officers on scene were in harms way as E- [REDACTED] ID was aware of their positions and the Officers were unable to see his hands to determine if he was armed. The wanted [REDACTED]

I DECLARE, UNDER PENALTY OF PURJURY, THIS STATEMENT OF [REDACTED] PII PAGES IS TRUE AND CORRECT, BASED ON MY PERSONAL KNOWLEDGE.

SIGNATURE OF PERSON GIVING STATEMENT [REDACTED] PII

REPRODUCED BY ALTAIR INFORMATION SYSTEMS, 12000 S. DEER CREEK DRIVE, DENVER, CO 80231

AUDIT RECORDS

SAN FRANCISCO POLICE DEPARTMENT

INCIDENT REPORT STATEMENT

page 2 of 2

INCIDENT NO.

suspect in this case had used deadly force upon officers immediately as they arrived on scene. I watched as "Roddy" entered the bushes and returned with a patch of cloth. I watched as numerous units ordered B- [ID] out of the bushes and attempted to pull him out. Due to the nature of the call and his failure to comply I instructed the Officers to retreat and ordered the K-9 to be released again. This time I could see Officer Byrne holding onto "Roddy" as he struggled with the suspect. I ran to the scene as Roddy pulled B- [ID] out of the bush area. Roddy had a hold of B- [ID] shoulder area and did not let go as [ID] violently resisted. I attempted to move in and handcuff [ID] Officer Byrne yelled "that he was going for it," as he reached for his waist band area. I observed [ID] reaching with his hands into his front waistband area. Fearing that he was going for a weapon, his prior actions and the safety of my fellow officers I kicked [ID] at least 3-4 times in the arm-chest-waist area. My use of force- (kicks) caused [ID] to stop reaching into his waist and to cover up his body. He was now in a defensive position as "Roddy" kept a hold of his shoulder. This action by Roddy pinned [ID] to the ground and did not allow him to move about freely. Numerous Officers attempted to handcuff [ID] but were unable to as Roddy was still controlling the suspect. Officer Byrne (the K-9 handler) coordinated the handcuffing in a safe fashion that did not allow any officer to get hurt. [ID] was bleeding from a hand-finger wound. A 408 was ordered for [ID] immediately. Officers on scene conducted a secondary search of [ID] for weapons and additional wounds.

A search of the immediate brush area under [ID] was conducted and Officer Garden #404 recovered a black semi auto pistol on top of the dirt. During the struggle with the K-9, [ID] had his black jacket and Black baseball cap pulled off his person. I noticed that B- [ID] had a bleeding hand wound and marks around his shoulder area. The black jacket had a lot of blood around the sleeve/cuff area. The blood appeared to be soaked into the jacket, not fresh blood from a bite wound.

Lt. Cota arrived on scene, I notified him immediately of my use of force and the bite by K-9 "Roddy" on the suspect. A/Lt. Kato was also notified. The suspect was transported for treatment of his injuries.

The following Officer's were on scene during the arrest: O'Brien, O'Leary, Lozano, Garden, Pera, Byrne and Sgt. Burke. Other Officers arrived during the arrest-handcuffing. The evidence was processed and recovered by CSI. The Homicide inspectors were notified of the events. We conducted additional searches in the area for suspects and evidence. I conducted a use of force investigation on scene and did not discover any additional witnesses. I determined that the suspect's actions caused injury to himself and only the force necessary to effect the arrest was used. I responded to Co. I and completed a use of force entry for Officer Byrne, K-9 -Roddy and myself. It was determined that [ID] may have "HEP-B", a report of contact will be completed by all team members.

A copy of this statement was booked by me at Co-E and faxed to the reporting Officer. Due to the active search for an attempted murder suspect Crime logs were not completed by SOG Officers.

The following Specialist Officers were on scene: Soohoo #2210, Mallinger # #116, Artiga #1417, Moriyama # 1791, O'Leary # 973, Lozano # 554, Matthews # 102, Garden # 404, Pera # 1397, O'Brien # 119, Juco # 4121, Chin # 188, Calasanz # 4158 Sgt. Burke # 2240 [PII]

RECORDED BY ALIATION SYSTEM ON 05/19/2007 10:00 AM

AUDIT RECORDS

I DECLARE, UNDER PENALTY OF PERJURY, THIS STATEMENT OF [ID] PAGES IS TRUE AND CORRECT, BASED ON MY PERSONAL KNOWLEDGE.

SIGNATURE OF PERSON GIVING STATEMENT [Redacted]

SAN FRANCISCO POLICE DEPARTMENT

INCIDENT REPORT STATEMENT

page 1 of 1

INCIDENT NO. [REDACTED]

NAME (LAST, FIRST, MIDDLE) OF PERSON GIVING STATEMENT OFFICER PERA #958		DOB/AGE ()	RESIDENCE PHONE (DAY / NIGHT) ()	BUSINESS PHONE (DAY/NIGHT) (415) 614-3400
RESIDENCE ADDRESS / CITY IF NOT SAN FRANCISCO		ZIP CODE	BUSINESS ADDRESS / CITY IF NOT SAN FRANCISCO 1125 FILLMORE	ZIP CODE 94115
DATE OF STATEMENT 5/19/07	TIME STARTED 635 HRS	TIME COMPLETED 740 HRS	LOCATION WHERE STATEMENT TAKEN <input type="checkbox"/> AT SCENE <input type="checkbox"/> OTHER: NORTHERN STATION	
STATEMENT TAKEN BY (NAME / STAR)		IN PRESENCE OF		

While working violence reduction in the Western Addition with Officer Dowke #799 we responded to Taraval and 47th street in regard to a shooting. Upon arriving I assumed Specialist Team duties. One of these duties was to search for the suspect with Sgt. Burke #2240. While searching we located a suspect, later to be identified as (B) [REDACTED] hiding inside a large bush near the intersection of The Great highway and Santiago. [REDACTED] was face down wearing a black jacket and black baseball cap. Sgt. Burke and I repeatedly gave verbal commands to [REDACTED] with negative results. [REDACTED] refused to comply with our orders or to show us his hands. Based on [REDACTED] being non-compliant, his clothing, his close proximity to the shooting, an unrecovered firearm, blood on his person and his hazardous hiding spot we determined that it was too dangerous to attempt a physical control on [REDACTED]. Officer Byrne #828 responded with his dog and detained [REDACTED] who continued to resist and refuse our verbal commands, see Officer Byrne's report. While Officer Garden #404 searched the area where [REDACTED] was hiding in the large bush he located a handgun which was partially buried, see Crime Scene Report. When [REDACTED] was being detained Officer OBrien #119, Officer O'Leary #973 and Officer Lozano #554 were also present. I booked this statement at Northern Station.

AUDIT RECORDS

I DECLARE, UNDER PENALTY OF PERJURY, THIS STATEMENT OF [REDACTED] PAGES IS TRUE AND CORRECT, BASED ON MY PERSONAL KNOWLEDGE.

SIGNATURE OF PERSON GIVING STATEMENT [REDACTED]

SAN FRANCISCO POLICE DEPARTMENT

INCIDENT REPORT STATEMENT

INCIDENT NO.

ID

page 1 of 2

NAME (LAST, FIRST, MIDDLE) OF PERSON GIVING STATEMENT SFPD #828		DOB/AGE	RESIDENCE PHONE (DAY / NIGHT) ()	BUSINESS PHONE (DAY/NIGHT) (415) 6713100
RESIDENCE ADDRESS / CITY IF NOT SAN FRANCISCO		ZIP CODE	BUSINESS ADDRESS / CITY IF NOT SAN FRANCISCO BLD 606	ZIP CODE
DATE OF STATEMENT 5/19/07	TIME STARTED 609 HRS	TIME COMPLETED HRS	LOCATION WHERE STATEMENT TAKEN AT SCENE <input type="checkbox"/> OTHER: CO C	
STATEMENT TAKEN BY (NAME / STAR)		IN PRESENCE OF		

While working with my K9 partner "Roddy", we responded to the area of 48th and Taraval to assist with the search for a suspect who had fired numerous rounds at officers and fled the scene. While searching the area of the Great highway, I heard Sgt Burke #2240 advise that he had located a possible suspect hiding in a large bush near the intersection of 48th and Santiago. Sgt Burke was ordering the subject from the bush but the subject refused to comply. Sgt Burke continued to give the subject orders but the subject ignored them. Sgt Burke noticed that the subject matched the suspect description and he broadcast that over the radio. Officers at the scene requested that a K9 unit respond to the scene to assist with taking the subject into custody.

I responded and upon arrival, I brought my dog to the bushes where the subject was located. I noticed the subject was sitting on the ground in the bush. I ordered the subject out by stating "come out or my dog may bite you", but he refused to comply with my orders. Other officers were also shouting orders but they were also ignored. I gave my dog a bark command to show the subject that in fact there was a police dog on scene. The dog began to bark and I yelled come out or I will send the dog. The this order was also ignored.

I realized that we were in a very dangerous situation and that the subject could see the officers better then we could see him. I was completely unable to see the subjects hands. I could see that the subject was reaching his arms downward. I felt that the subject could shoot and kill any of the officers before we could even see a gun.

I heard Sgt Laylor #874 order me to send the dog. I gave my dog a bite command and sent him into the bush. The dog entered the bush, made his way through the thick branches and bit the subject on his upper torso. I had a 15 foot long leash on the dog. With the leash, I attempted to pull the subject from the bushes while the dog was on the bite but when I pulled, the subjects jacket tore and the dog came out of the bushes with the torn piece of jacket in his mouth. Sgt Laylor then ordered that the dog be sent back in. I again gave the dog a bite command and sent him back into the bush. The dog bit the subject once and held on. I was then able to pull the subject from the bushes and into a grassy area and while doing so, I watched the subject reach towards his waistline with his left hand. I thought he was reaching for a gun and I shouted "he is going for it". At this time, Sgt Laylor stepped up to the subject and kicked his arm away from his waistline.

Numerous officers surrounded him to take him into custody. The subject began to struggle with the dog and it appeared to he that he was trying to roll over. Officers then began to handcuff the subject but they were unable to cuff his right wrist while the dog was still on the bite. The officers told me of this and told me to remove the dog from the bite so he could be cuffed. I gave the dog a command to release and he did so. The subject was then handcuffed and taken into custody.

I DECLARE, UNDER PENALTY OF PURJURY, THIS STATEMENT OF 2 PAGES IS TRUE AND CORRECT BASED ON MY PERSONAL KNOWLEDGE.

SIGNATURE OF PERSON GIVING STATEMENT

SAN FRANCISCO POLICE DEPARTMENT

INCIDENT REPORT STATEMENT

INCIDENT NO.

page 2 of 2

An ambulance was called for the subject. Upon arrival, the ambulance crew began to treat the subject for his injuries. I took photographs of the subjects injuries and while doing so, I observed that the subject was bleeding from a wound on his finger. I heard the subject state that he was bit on the finger by my dog but the wound did not appear to be consistent with a dog bite injury. When the paramedics removed that subjects shirt, I noticed injuries consistent with a dog bites on the left side of the subjects back and on the subjects upper right biceps. I also noticed that the subject had what appeared to be dried blood on the front side of his pants. There was no blood on the subjects T-shirt, near the area of the dog bites. Neither the bite on his back and biceps had bled. At this time, if the dog bites had bled, the blood would still be fresh. I believed that the subject was indicating that the dog bit his finger as a way to cover up and injury sustained during the shooting.

I observed the jacket that subject was wearing and I noticed that there was a rip and a piece of material missing on the left back and that one of the wrist areas of the jacket had dried blood on it.

41300, Capt. Mcdonagh #377 and 4T201, Lt. Cota #357, who were on the scene were advised of the dog bites. Sgt Laylor advised me that he would enter the dog bites in the use of force log at Taraval Station. I made a duplicate entry in the use of force log at the Tactical Unit. I retained the photo disk for my K9 Records. I booked the original copy of this statement as evidence at Co C.

I DECLARE, UNDER PENALTY OF PERJURY, THIS STATEMENT OF 2 PAGES IS TRUE AND CORRECT, BASED ON MY PERSONAL KNOWLEDGE.

SIGNATURE OF PERSON GIVING STATEMENT

[Redacted Signature]

INCIDENT REPORT STATEMENT

SAN FRANCISCO POLICE DEPARTMENT

page 1 of 1

INCIDENT NO. [REDACTED]	ID [REDACTED]	DOB / AGE	RESIDENCE PHONE (DAY / NIGHT)	BUSINESS PHONE (DAY/NIGHT)
NAME (LAST, FIRST, MIDDLE) OF PERSON GIVING STATEMENT		RESIDENCE ADDRESS / CITY IF NOT SAN FRANCISCO		
H. BRAHAMSEN T. #450		2345 24TH AV. CO I 94116		
DATE OF STATEMENT	TIME STARTED	TIME COMPLETED	LOCATION WHERE STATEMENT TAKEN	
5/19/07	1205		AT SCENE <input type="checkbox"/> OTHER: CO I	
STATEMENT TAKEN BY (NAME / STAR)		IN PRESENCE OF		

On 5/19/07 AT APPROXIMATELY 0630 HR. OFF DONATI #1403 AND I RESPONDED TO SFGH AND ASSUMED CUSTODY OF B.I.F. [REDACTED] FROM OFF. OSHITA #4112, GUARDADO #395, AND BIGGS #1800. WHILE AT SFGH, I TOOK E / PHOTOS OF [REDACTED] REPORTED INJURIES WITH MY DIGITAL CAMERA OFF. DONATI AND I, ALONG WITH A MISSION UNIT 3D14A, TRANSPORTED [REDACTED] TO THE HOMICIDE DETAIL, WHO TOOK CUSTODY OF [REDACTED] I BOOKED THE ABOVE PHOTOS AS EVIDENCE AT CO I.

I DECLARE, UNDER PENALTY OF PERJURY, THIS STATEMENT OF [REDACTED] PAGES IS TRUE AND CORRECT, BASED ON MY PERSONAL KNOWLEDGE.

SIGNATURE OF PERSON GIVING STATEMENT [REDACTED]

INCIDENT NO.

[REDACTED] ID

NAME (LAST, FIRST, MIDDLE) OF PERSON GIVING STATEMENT BURKE, JOHN F. SFPD #2240		DOB/AGE	RESIDENCE PHONE (DAY / NIGHT) () Refused	BUSINESS PHONE (DAY/NIGHT) (415) 671-2300
RESIDENCE ADDRESS / CITY IF NOT SAN FRANCISCO REFUSED		ZIP CODE	BUSINESS ADDRESS / CITY IF NOT SAN FRANCISCO SFPD Co. C 201 WILLIAMS STREET	ZIP CODE 94124
DATE OF STATEMENT 5/29/07	TIME STARTED 0113 HRS	TIME COMPLETED HRS	LOCATION WHERE STATEMENT TAKEN AT SCENE <input type="checkbox"/> OTHER: 201 WILLIAMS	
STATEMENT TAKEN BY (NAME / STAR) SELF		IN PRESENCE OF		

On Saturday 5/19/2007 at 01:00 hours I was on duty in full uniform working as a patrol sergeant in the Bayview District, radio call sign 3C115. I heard over PIC channel 8 that 31200 Sergeant Kato call for Tactical and Specialist Units to respond to the area of 47th Avenue and Taraval Street for an incident in which a suspect shot at uniformed officers who were investigating a burglary. I responded to the scene as a specialist sergeant. As this event unfolded and throughout the incident of trying to locate this suspect, I became aware that the suspect had left a blood trail along the path that he took in his attempt to elude the police. I personally saw some of this blood trail on the front steps, and along the wall around the front steps at [REDACTED] 47th Avenue. While looking at this blood residue, it was obvious that the blood was smeared onto the wall from the person's hand while walking up and then down the stairs. I could see that the blood was from the suspect's hand, leading me to believe that our suspect had a hand wound. I last saw the blood trail on the North facing wall of the Southwest corner building at 47th Avenue and Santiago. The blood trail seemed to indicate that the suspect fled South along the building line on the West side of the street of 47th Avenue from Taraval towards Santiago, then he went West on Santiago from 47th Avenue.

Later, in the early morning hours, Officer Pera and I were part of a squad of officers searching/walking Northbound in a skirmish line that stretched from the Lower Great Highway to Ocean Beach. Officer Phil Pera and I located a person, who was arrested as the suspect in this incident. We found the suspect hiding inside a "hedgerow" that was along the grass between the Lower Great Highway and the Upper Great Highway at Santiago. When I first encountered this suspect, I saw only about a 15 inch by 3 inch piece of nylon which turned out to be his black puffy coat, inside the underbrush of this hedgerow. As I walked inside the underbrush to investigate, I pushed on the piece of nylon, and discovered the suspect. I saw that he had covered up himself with leaves, and brush in an attempt to conceal himself. I identified myself verbally as a police officer and ordered him to come out of the brush. The suspect replied, "I'm homeless and just trying to sleep, leave me alone." At this point Officer Pera and I were probably four feet away from the suspect and both of us had our department issued weapons and flashlights on the pointed at the suspect. Officer Pera and I gave the suspect numerous commands to come out of the brush, and to show his hands. The suspect was concealing his hands under his body. His refusal of showing us his hands was a point of concerned for us for several reasons. Primarily it was an officer safety issue, because we suspected this person to be our suspect, who had shot at uniformed officers with a handgun, which still had not been recovered. It was also an issue, that this person, who was maintaining that he was only a homeless person, who was not involved in the shooting incident, refused to show his hands, which if shown, might reveal a presence of a wound, which would have further confirmed that he was the suspect that had shot at the police and fled.

I DECLARE, UNDER PENALTY OF PURJURY, THIS STATEMENT OF [REDACTED] PAGES IS TRUE AND CORRECT, BASED ON MY PERSONAL KNOWLEDGE.

SIGNATURE OF PERSON GIVING STATEMENT

[REDACTED SIGNATURE]

INCIDENT NO.

page 2 of 2

For several minutes, numerous officers including Officers Phil Pera, Keith Matthews, Angel Lozano and I gave the suspect numerous commands to show his hands and crawl out of the brush. The suspect remained in his position in the brush with his hands concealed under his body.

At this point Officer O'leary suggested that we call for a SFPD Dog unit to assist in getting the suspect out of the brush and in custody. Officer Byrne and his dog arrived on scene and Officer Byrne admonished the suspect that if he didn't come out of the bushes with his hands in the air that he (Officer Byrne) was going to release the dog on him (the suspect). The suspect continued to refuse to show his hands or come out of the bushes as he was ordered to. Officer Byrne released the dog on the suspect. As the dog moved towards the suspect, barking, the suspect held up his hands in front of his face in a defensive move to protect his face, anticipating that the dog was going to bite him. Prior to the dog contacting the suspect, I could see that the suspect had dried blood on his hands, which was consistent with the blood trail of the suspect that had fled from the police. I also saw Officer Byrne's dog bite and contact the suspect by the suspect's coat. I was right on the suspect as he was taken into custody. I never saw Officer Byrne's dog bite or contact the suspect's hands. Officer Byrne's dog dragged the suspect out of the brush where he was placed into custody.

I later saw Officer Jason Garden locate and seize a semi-automatic type pistol in the dirt under where the suspect was located.

I DECLARE, UNDER PENALTY OF PURJURY, THIS STATEMENT OF [Signature] PAGES IS TRUE AND CORRECT, BASED ON MY PERSONAL KNOWLEDGE.

SIGNATURE OF PERSON GIVING STATEMENT

[Redacted Signature]



San Francisco Police Department Cold Show Admonition and Report

- *Police Department personnel intend to take you to a location where you will be asked to look at a person(s) to help determine if that person(s) committed the crime.
- *The person(s) you will see may or may not be the perpetrator(s) of the crime being investigated by the police.
- *You should not assume that the person(s) you will look at committed the crime.
- *You are under no obligation to identify anyone.
- *You should not discuss this matter with any other victims/witnesses.

Please sign your name to confirm that you have read and understand the above.

[Redacted Signature]

Signature of Person Viewing

GREAT HWY / SAN TIAAGO
Location

[Redacted Name]

Printed Name of Person Viewing

05/19/07
Date

0535
Time

ROUDE #974
Officer/Star

[Redacted ID]
Incident Report Number

Does the person viewing the cold show wear eyeglasses or contact lenses? NO. If yes, did the person viewing the cold show wear their corrective lenses at the cold show? _____

Was the person viewing the cold show wearing their corrective lenses at the time of the incident? NO

What was the approximate viewing distance at the cold show? 20 feet. MEDIC 19 AMBULANCE LIGHT

How was the person(s) being viewed illuminated? Spotlight Headlights Flashlight Streetlight Other

Was the person(s) being viewed restrained? YES. If yes, how? HANDCUFFED

Victim/Witness Statement (document statements made by victim/witness while viewing cold show)

"THAT MIGHT BE HIM, HIS HAIR LOOKS LIKE THAT,
HE HAS THE SAME COMPLEXION"

Please continue on the reverse side of this form

POWERED BY ALTIMETRON FOR SAN FRANCISCO POLICE DEPARTMENT
AUDIT RECORDS

SAN FRANCISCO POLICE DEPARTMENT

CRIME SCENE LOG

INCIDENT NUMBER: [REDACTED] ID [REDACTED]

TYPE OF INCIDENT: 459/217

LOCATION: PII [REDACTED] 48TH AVENUE

DATE/TIME OF INCIDENT: 05-19-07

OFFICER MAINTAINING LOG: OFFICER WALSH

STAR: 1106

DATE/TIME LOG STARTED: 5/19/07 0120hrs

RELIEF OFFICER: HERASURA / ESCOBAR #1848

STAR: 1998

DATE/TIME: 05/19/07 @ 415

TIME IN	NAME	POSITION/TITLE	REASON FOR ENTRY	TIME OUT
120	WALSH, C #1106			0415
120	GALLAGHER #1422			125
122	BYRNE #828			125
122	SGT. DANIELE #93	3H103		130
120	PHILLIPS #4072	3H1105		125
130	SGT. BROWN #1893	50105		140
48	SANYER #489 127			155
48	FARMER #489			155
48	GARDEN			155
230	OSHIZ #4112			235
230	BIGGS #1760			235
230	ESCOBAR #1848			255
230	MALLINGER #116	542		245
230	MORIYAMA #1791	543		245
235	CAVANAUGH #764	MEDIC (RC3)		245
310	PHILLIPS #4072	3H1105		0400
310	GALLAGHER #1422	3H130		0415
24	GREGORY #986	CSF (5L7)		0430
24	GEE #574	CSF		0430
30	COTA #357	LT.		0332
30	MCCONNAGH #377	CPT.		0332
38	CP. TITEL #2104	NIGHT CPT. (3X201)		0345
38	INSP. MCFADDEN #2236	MCD		0400
39	EVERSON #1001	HOMICIDE		0405
48	MAFFEI #203	HOMICIDE		0405
103	GAYMOR #1524			0405
103	[REDACTED]			0405

MIRIN

TIME

519 SGT. MANNINA PUBLIC AFFAIRS

610 SWEENEY #604 5LIL

616 OFC. D. LEE #4126 3I1D

617 OFC. Calaman #58 3I13D

620 OFC. Ruede #974 3I5E

632 OFC. Chan #886 3I10

645 Capt. Sanford #1414 3I300

646 Sgt. Avon #555 3I100

0525

0800

0700

0700

0627

0840

0705

0705

RELIEF 05-19-07
0700
SGT. Δ KATO 692

0750

0715 GAOSER 1930

0715 PHILLIP 1697

0715 SCHMIDT 1334

0741 CAPT. SANFORD 1414

0741 OFFICER MANNICA

0736

0736

0730

0830

0830

AUDIT RECORDS

REPORT NUMBER: [Redacted] ID [Redacted]

TYPE OF INCIDENT: 459/217

LOCATION: [Redacted] PII 48TH AVE

DATE/TIME OF INCIDENT: 5-19-07

OFFICER MAINTAINING LOG: RELIEF OFFICER FOR PAGE 1

STAR: 585

DATE/TIME LOG STARTED: 5-19-07 0745 HRS

RELIEF OFFICER: J. KING

STAR: 810

DATE/TIME: 5/19/07 0755 PM

TIME IN	NAME	POSITION/TITLE	REASON FOR ENTRY	TIME OUT
0745	KELLY HOLT		OWNER OF 2382 ^{GRT} HWY	0805
0745	R. CURRY #585	OFF. / 347	CRIME SCENE LOG RELIEF	0755
0755	J. KING #810	OFF. /	CRIME SCENE LOG RELIEF	0830

PROPERTY OF SAN JOSE POLICE DEPARTMENT
AUDIT RECORDS

SAN FRANCISCO POLICE DEPARTMENT

INCIDENT REPORT STATEMENT

INCIDENT NO.

page 1 of 1

ID [REDACTED]

NAME (LAST, FIRST, MIDDLE) OF PERSON GIVING STATEMENT OFFICER CHARLES CHAN #1886		DOB/AGE	RESIDENCE PHONE (DAY / NIGHT) (415) 759-3100	BUSINESS PHONE (DAY/NIGHT) (415) 553-1612
RESIDENCE ADDRESS / CITY IF NOT SAN FRANCISCO TARAVAL POLICE STATION		ZIP CODE	BUSINESS ADDRESS / CITY IF NOT SAN FRANCISCO 2345-24TH AVENUE, SF CA	ZIP CODE 94116
DATE OF STATEMENT 5/19/07	TIME STARTED HRS	TIME COMPLETED HRS	LOCATION WHERE STATEMENT TAKEN AT SCENE <input type="checkbox"/> OTHER: Co. "I"	
STATEMENT TAKEN BY (NAME / STAR) OFF. PALMA 841		IN PRESENCE OF		

On Saturday, May 19, 2007, at approximately 6:30 a.m., I was on uniform patrol assigned to a marked black and white police unit [3110]. Lt. D. O'Leary #1892 directed me to respond to Taraval Street and 48th Avenue regarding an officer involved incident (See initial report # [REDACTED] ID).

When I arrived, I took digital photos of the marked black and white vehicle #B531 [license plate: [REDACTED] ID] vehicle (V1), green Nissan Quest XE [license plate: [REDACTED] PII] vehicle (V2), and blue Nissan [license plate: [REDACTED] PII] vehicle (V3). I also took a digital photo of the green Gary Fisher bicycle serial number # [REDACTED] PII.

I contacted and located the property owner of [REDACTED] PII 48th Avenue and the registered owner of the parked and unattended vehicles (V2) and (V3).



ID, PII

Police vehicle #B531 (V1), and vehicles (V2) and (V3) were towed from the crime scene with a hold for Homicide Detail pursuant to California Vehicle Code section 22655.5. I gave the above-listed owners a Follow-Up Reportee Form. I booked the digital photos (15) and disk, and statement into evidence at Taraval Police Station.

I DECLARE, UNDER PENALTY OF PERJURY, THIS STATEMENT OF [REDACTED] PII PAGES IS TRUE AND CORRECT, BASED ON MY PERSONAL KNOWLEDGE.

SIGNATURE OF PERSON GIVING STATEMENT [REDACTED]

INCIDENT NUMBER: [REDACTED] ID [REDACTED]

TYPE OF INCIDENT: 459 / 217

LOCATION: PI [REDACTED] GREAT HIGHWAY

DATE/TIME OF INCIDENT: 5-19-07 0102 hrs

OFFICER MAINTAINING LOG: OSHITA

STAR: 4112

DATE/TIME LOG STARTED: 05/19/07 0330

RELIEF OFFICER: D. LEE 4126 / M. PALMA # 841

STAR:

DATE/TIME: 5-19-07 0400

TIME IN	NAME	POSITION/TITLE	REASON FOR ENTRY	TIME OUT
0320	S/DARE	897	INVEST	0400
0330	S/DANIELE	93	INVEST	0400
0330	S/BROW	1993	INVEST	0400
0330	OSHITA	4112	INVEST	0400
0330	B/663	1760	INVEST	0400
0414	D. LEE	4126	INVEST	0600
0400	M. HIGGA	1295	INVEST	0435
0400	M. PALMA	841	INVEST	0435
0446	R. GEE	574	CSI	0507
0528	R. GEE	574	CSI	0549

AUDIT RECORDS

INCIDENT NUMBER: ID [REDACTED]

TYPE OF INCIDENT: OFFICER INVOLVED SHOOTING

LOCATION: PII [REDACTED] 47th Ave DATE/TIME OF INCIDENT: 05/19/2007

OFFICER MAINTAINING LOG: ~~XXXXXXXXXX~~ ADAMSON #416 STAR: ~~(scribble)~~ DATE/TIME LOG STARTED: 05/19/2007

RELIEF OFFICER: STAR: DATE/TIME:

TIME IN	NAME	POSITION/TITLE	REASON FOR ENTRY	TIME OUT
0645	SWEENEY #605	CSI INSP	INVESTIGATION	0715
0732	LEE RAY #574	CSI INSP	INVESTIGATION	0745
0732	GANSTER, SANDY #1830	CSI INSP	INVESTIGATION	0745

PRODUCED BY AUDIT RECORDS

ID	A	459	PII	GREAT HY, SF (D=3I PACHECO ST & QUINTARA ST)
01:02:34	CT14	ENTRY	RP [REDACTED] ID, PII [REDACTED] B F	DIPH: [REDACTED] PII [REDACTED] DRIGIN:E911\TX:RP'S BIKE JUST STOLEN OUT OF 1020'S GARAGE...2 MALES LS ON FOOT SB ON GRT HY W/RP'S BIKE...BIKE SILVER IN COLOR...RP WILL CB W/FURTHER
01:03:07	DP06	DISP-ENR	3I13E:P	
01:03:07	DP06	PERS-ID	3I13E < [REDACTED] PII [REDACTED] PALMA MICHAEL A/0841 < [REDACTED] PII [REDACTED] HIGA MARC M/1295	
01:03:36	CT14	SUPP	TX:RPS HUSBAND POSS CHASING THE SUSP SB ON GRT HWY...RPS HUSBAND W/A DOG..RP HU TO GET FURTHER WILL CB	
01:06:13	DP06	BACK-ENR	3I13E 3I16E:P	
01:06:13	DP06	PERS-ID	3I16E < [REDACTED] PII [REDACTED] CRAVALHO DENNIS V/1783 < [REDACTED] PII [REDACTED] MORGADO PAULO M/0466	
01:06:26	M211	BACK-ENR	3I13E 3I5E:P	
01:06:26	M211	PERS-ID	3I5E < [REDACTED] PII [REDACTED] ROUEDE ANGELA M/0974	
01:07:12	DP11	MISC	3I16E, CODE 33	
01:07:12	DP06	MISC	3I16E, C33	
01:07:26	M250	ONSCENE	3I13E	
01:07:33	DP06	MISC	3I16E, SHOTS FIRED	
01:07:33	DP11	MISC	3I16E, SHOTS FIRE	
01:07:41	DP05	MISC	3I16E, TAR/GREAT	
01:07:43	DP06	MISC	3I16E, GREAT HWY/TARA	
01:07:43	DP11	MISC	3I16E, GREAT HWY AND TARAVAL	
01:07:46	DP11	BACK-ENR	3I16E 3I91:P	
01:07:46	DP11	PERS-ID	3I91 < [REDACTED] PII [REDACTED] BIGGS SCOTT B/1760 < [REDACTED] PII [REDACTED] OSHITA YUKIO C/4112	
01:07:49	DP05	MISC	3I16E, RUNNING UP TARAVAL	
01:07:52	DP11	MISC	3I16E, RUNNING UP TARAVAL NOW	
01:07:53	DP06	MISC	3I16E, RUNNING UP TARAVAL	
01:07:55	DP06	MISC	BLK JKT	
01:07:55	DP05	MISC	3I16E, BLK JKT	
01:07:55	DP11	MISC	3I16E, BLK JKT	
01:08:02	DP06	MISC	BE CAREFUL .. OPENED FIRE ON PD	
01:08:03	DP05	MISC	3I16E, BE CAREFUL HE OPENED FIR ON US	
01:08:05	M318	BACK-ENR	3I16E 3I11E:P	
01:08:05	M318	PERS-ID	3I11E < [REDACTED] PII [REDACTED] LEE NORMAN S/0264 < [REDACTED] PII [REDACTED] DERRO WILLIAM A/4153	
01:08:07	M238	BACK-ENR	3I16E 3I13D:P	
01:08:07	M238	PERS-ID	3I13D < [REDACTED] PII [REDACTED] CALAUNAN REX F/0058 < [REDACTED] PII [REDACTED] ESCOBAR ROLANDO A/1848	
01:08:09	DP05	MISC	3I16E, UNITS TO GO C3	
01:08:11	DP11	BACK-ENR	3I16E 3H11D:P	
01:08:11	DP06	MISC	UNITS RESP C/3	
01:08:11	DP11	PERS-ID	3H11D < [REDACTED] PII [REDACTED] PHILLIPS SHAWN A C/4072 < [REDACTED] PII [REDACTED] MORRIS CHRISTOPHER M/1916	
01:08:15	DP11	MISC	3H11D, RESPONDING CODE 3	
01:08:17	DP05	BACK-ENR	3I16E 3H13D:P	
01:08:17	DP05	PERS-ID	3H13D < [REDACTED] PII [REDACTED] GALLAGHER JASON J/1422 < [REDACTED] PII [REDACTED] WALSH CARMEN E/1106	
01:08:21	DP11	BACK-ENR	3H11D 3H16D:P	
01:08:21	DP11	PERS-ID	3H16D < [REDACTED] PII [REDACTED] ROPELATO TYLER/1255 < [REDACTED] PII [REDACTED] YOUNG WAYMAN W/0100	
01:08:24	M400	BACK-ENR	3I16E 3G15E:P	
01:08:24	M400	PERS-ID	3G15E < [REDACTED] PII [REDACTED] BROTHERS TODD A/4049 < [REDACTED] PII [REDACTED] RADFORD DAVID C/0316	
01:08:33	DP11	BACK-ENR	3I16E 3H110:S 3H200:S	
01:08:33	DP11	PERS-ID	3H110 < [REDACTED] PII [REDACTED] DARE GREGORY R/0897	
01:08:33	DP11	PERS-ID	3H200 < [REDACTED] PII [REDACTED] DANIELE ROBERT G/0093	
01:08:38	M238	ACKUNIT	3I13D	
01:08:40	M436	BACK-ENR	3I16E 3H11E:P	

01:08:40	M436	PERS-ID	3H11E < [REDACTED] PII > JEFFERSON JASON D/0806 < [REDACTED] PII > MORROW LEONARD C/1196
01:08:42	DP05	MISC	3116E, CLEAR THE AIR. 47TH/TARAVAL SHOTS FIRED HIDING BEHIND 1 OF THE VEHS
01:08:42	DP06	MISC	3116E, 47TH/TARAVAL .. SHOTS FIRED .. HIDING BEHIND VEH
01:08:42	CT14	PRIOR	903P YESTERDAY S0630 (93 MORE)
01:08:42	CT14	SUPP	RP:T-MOBILE [REDACTED] PII OPT 5VAD:W911-[REDACTED] PII #W911-T-MOBILE [REDACTED] PII OPT 5\PH:[REDACTED] PII ORIGIN:E911\TX:ACROSS FROM THE TACO BELL ON THE CORNER...LMA PICKED X UP AND THREW HER...STILL 97 IN VERBAL...LMA 20S...WEARING BLK PANTS..BLK PARKA...BLK CAP
01:08:42	CT14	UPDATE	LOCATION: [REDACTED] PII GREAT HY, SF (D=31 PACHECO ST & QUINTARA ST)-->20TH AV/IRVING ST, SF (D=31 PII 20TH/ [REDACTED] PII IRVING) TYPE:459-->418DV RD:940-->906B BEAT:I3-->I2
01:08:45	M219	BACK-ENR	3116E 3116D:P
01:08:45	M219	PERS-ID	3116D < [REDACTED] PII > SIGUIDO BUDDY R/4212 < [REDACTED] PII > CHU THOMAS M/4200
01:08:46	DP11	MISC	3116E, 47TH AND TARAVAL..SHOTS FIRE...HIDING BEHIND ONE OF VEHS
01:08:54	DP06	MISC	UNIT SANTIAGO .. ON 47TH
01:08:57	DP05	MISC	3116E, NEED A UNIT AT SANTIAGO, HE'S ON 47TH, NEED PERIMETER
01:08:57	DP06	MISC	SET PERIM
01:08:59	CT17	PRIOR	459 TODAY S0203
01:08:59	CT17	SUPP	RP: [REDACTED] ID, PII #WPH2-CONF 728 FT, 090 % -CINGULAR BLUE 1-80PH: [REDACTED] PII ORIGIN:E911\TX:RP STATE SHER SON SAW A BMA WHO WAS INSIDE THE GARAGE AND WAS JUST ON THE CORNER OF GREAT HIGHWAY AND PACHECO***BUT NOW HE HAS TAKEN OFF IN UNK DIRECTION.....OTHER 2 SUBJ HAVE BICYCLES BUT UNK RACES ON THEM AND THEY WENT
01:08:59	CT17	SUPP	RP: [REDACTED] ID VAD:WPH2-[REDACTED] PII #WPH2-CONF 728 SB ON GREAT HIGHWAY
01:08:59	CT17	UPDATE	LOCATION:20TH AV/IRVING ST, SF (D=31 PII 20TH/ [REDACTED] PII IRVING)--> [REDACTED] PII GREAT HY, SF (D=31 PACHECO ST & QUINTARA ST) RD:906B-->940 BEAT:I2-->I3
01:09:02	M409	BACK-ENR	3116E 3H41:P
01:09:02	M409	PERS-ID	3H41 < [REDACTED] PII > LEE CARLA/1583 < [REDACTED] PII > ODUM ROBIN L/0983
01:09:04	DP05	CLOC-ONS	315E 4TH/SANTIAGO
01:09:07	DP11	MISC	3116E, NEEDS UNITS AT SANTIAGO...ON 47TH...NEEDS TO SET UP A PERIMETER
01:09:09	DP05	CLOC-ONS	315E 47TH AV/SANTIAGO ST,SF
01:09:17	DP02	MISC	OPS NTFD
01:09:19	DP06	MISC	SAFE AVE .. WB TARAVAL .. HAVE BLKD IN ***
01:09:21	DP11	MISC	3116E, SAFE AVENUE OF APPROACH...WB TARAVAL
01:09:25	CT14	PRIOR	459 TODAY S0203 (94 MORE)
01:09:25	CT14	SUPP	TX:WFA OR LFA...18 TO 20YO...PINK JKT..BLU JNS...PER RP ANOTHER MALE JUST WALKED UP
01:09:25	CT14	UPDATE	LOCATION: [REDACTED] PII GREAT HY, SF (D=31 PACHECO ST & QUINTARA ST)-->20TH AV/IRVING ST, SF (D=31 PII 20TH/ [REDACTED] PII IRVING) RD:940-->906B BEAT:I3-->I2
01:09:26	DP11	BACK-ENR	3116E 3I200:S
01:09:26	DP11	PERS-ID	3I200 < [REDACTED] PII > KATO JODY L/0692
01:09:28	DP05	MISC	3116E, WB TARAVAL IS SAFE AVE OF APPROACH... HE'S BLOCKING IN 47TH BTWN SANTIAGO AND TARAVAL
01:09:34	DP11	MISC	3I200, NEEDS TAC SPEC UNITS
01:09:34	DP05	MISC	3116E, NEED TAC OR SPEC UNITS
01:09:36	DP06	MISC	3I200, SPEC OR TAC UNIT TO RESP
01:09:51	DP05	MISC	3116E, NEED SOMEONE AT 46TH
01:09:52	DP11	MISC	3116E, NEED 46TH...

01:09:54	DP06	MISC	3I16E, NEED 46TH .. HAVE BLOCKED IN
01:10:02	DP06	ONSCENE	3I200
01:10:10	M265	MISC	3H13D, CODE 3
01:10:10	DP06	MISC	3I16E, 46TH/SANTIAGO
01:10:11	DP11	MISC	3I16E, 46TH AND SANTIAGO...
01:10:14	DP11	BACK-ONS	3I16E 3I5D:P
01:10:14	DP11	PERS-ID	3I5D < [REDACTED] RAMOS MARILU/1993
01:10:17	DP05	CLOC-ONS	3I5D 46TH AV/SANTIAGO ST,SF
01:10:18	DP12	BACK-ENR	3I16E 3C115:S
01:10:18	DP06	CLOC-ONS	3I5D 46TH AV/SANTIAGO ST,SF
01:10:18	DP11	CLOC-ONS	3I5D 46TH AV/SANTIAGO ST,SF
01:10:18	DP12	PERS-ID	3C115 < [REDACTED] BURKE JOHN F/2240
01:10:22	DP11	CLOC-ONS	3I16D 46TH AV/SANTIAGO ST,SF
01:10:22	DP05	CLOC-ONS	3I16D 46TH AV/SANTIAGO ST,SF
01:10:22	CT14	PRIOR	459 TODAY S0203
01:10:22	CT14	SUPP	TX:CHANGED BY ACCIDENT DISREGARD LAST ENTRIES
01:10:22	CT14	UPDATE	LOCATION:20TH AV/IRVING ST, SF (D=3I [REDACTED] 20TH/ [REDACTED] IRVING)--> [REDACTED] GREAT HY, SF (D=3I PACHECO ST & QUINTARA ST) RD:906B-->940 BEAT:12-->I3
01:10:27	DP07	BACK-ENR	3I5D 4T72E:UN 4T72D:UN
01:10:27	DP07	PERS-ID	4T72E < [REDACTED] DOWKE JAY K/0799
01:10:27	DP07	PERS-ID	4T72D < [REDACTED] PERA PHILIP M/0958
01:10:33	DP11	MISC	3I16E, NEED A UNIT AT 47TH/SANTIAGO
01:10:41	DP01	BACK-ENR	3I5D 4T3B:UN
01:10:41	DP01	PERS-ID	4T3B < [REDACTED] JONES WENDELL A/0947
01:10:44	DP12	BACK-ENR	3I16E 4T72A:UN
01:10:44	DP12	PERS-ID	4T72A < [REDACTED] CALASANZ ANTHONY D/4158
01:10:45	DP11	CLOC-ONS	3I5E 47TH AV/SANTIAGO ST,SF
01:10:55	DP11	BACK-ENR	3I16E 3X301:UN
01:10:55	DP11	PERS-ID	3X301 < [REDACTED] TITTEL STEPHEN M/2104
01:11:13	DP05	MISC	3I200, NEED SOMEONE AT 48TH AND 46TH
01:11:15	DP06	MISC	3I200, 48TH AND 46TH .. INCREASING PERIM
01:11:16	DP12	BACK-ENR	3I16E SP107:UN
01:11:25	DP05	CLOC-ONS	3I5E 45TH AV/SANTIAGO ST,SF
01:11:28	DP11	CLOC-ONS	3I5E 45TH AV/SANTIAGO ST,SF
01:11:33	DP12	MISC	4T72A, SPEC 80...CAD WILL NOT TAKE UNIT ID
01:11:43	DP12	MISC	SP107, THIS IS 3C115
01:11:51	M366	BACK-ENR	3I200 3G200:S
01:11:51	M366	PERS-ID	3G200 < [REDACTED] OLEARY SEAN P/1150
01:12:03	DP11	MISC	3I16E, LS RUNNING NB ON 47TH..RIGHT BEHIND ,,,,LMA OR WMA...WRNG BLK WAIST LENGTH JKT WITH A BB CAP
01:12:05	DP05	MISC	3I16E, LS RUNNING NB 47TH, WML - TOO DARK, BLK WAISTLENGT H JKT, BB CAP
01:12:09	DP06	MISC	3I16E, LS NB 47TH .. RIGHT BEHIND HIME .. WMA OR LMA .. BLK WAIST LENGTH JKT W/ BB CAP
01:12:29	M436	CLEAR	3H11E
01:12:40	DP11	MISC	3I200, NOW WANTS A HELICOPTER
01:12:42	DP05	MISC	3I200, HELICOPTER?
01:12:45	SU06	DUP-OF	[REDACTED] ID
01:12:46	DP06	MISC	HELICOPTER .. CALLING CHP
01:12:51	DP06	MISC	TAKE COVER
01:12:57	DP05	MISC	3I200 TO 3I5E- TAKE COVER
01:13:13	DP05	MISC	3X301, 3I200 TO 901
01:13:29	DP11	MISC	3I200, TRY TO GET CITIZENS AWAY FROM THE AREA
01:13:53	M222	BACK-ENR	3I5D 3I1D:P

01:13:53	M222	PERS-ID	3I1D < [REDACTED] PII > LEE DEAN K/4126
01:13:54	DP06	MISC	GET CITIZENS AWAY FROM AREA .. WIDEN PERIM .. 1 UNIT AT 46TH/TARA .. 46TH/SANTIAO ..
01:13:57	DP05	CLOC-ONS	3G15E 46TH AV/TARAVAL ST,SF
01:13:59	DP11	CLOC-ONS	3G15E 46TH AV/TARAVAL ST,SF
01:14:02	DP06	MISC	3I200, UNIT TO BLK STREET .. BLK TRAFF
01:14:04	DP05	MISC	3I200, NEED UNITS TO BBLOCK VEH TRAFFIC
01:14:11	DP05	MISC	3I200, COMMAND POST AT 47TH/TARAVAL
01:14:12	M284	BACK-ENR	3I16E 3H4D:P
01:14:12	DP11	MISC	3I200, 47 AND TARAVAL - COMMAND POST
01:14:12	M284	PERS-ID	3H4D < [REDACTED] PII > RAMOSO ARMANN W/0658
01:14:13	DP06	MISC	*** COMMAND POST 47TH/POST ***
01:14:18	M366	CLEAR	3G200 HAN
01:14:18	DP11	DSPINFO	3I200 47TH AND TARVAL - COMMAND POST
01:14:23	DP06	MISC	*** COMMAND POST 47TH/TARAVAL ***
01:14:43	DP05	MISC	3I200, A8 ONLY FOR C33
01:14:49	DP02	MISC	CHP NTFD
01:14:53	DP11	MISC	3I200, CODE 33 ON A8 ONLY
01:14:56	DP12	BACK-ENR	3I16E SP29:UN
01:15:04	DP12	MISC	SP29, THIS IS 3D61S
01:15:05	DP06	MISC	CHP ADV'D THEY WILL LET HELICOPTOR KNOW .. WILL CB W/ ETA
01:15:11	M284	ONSCENE	3H4D
01:15:18	M409	ONSCENE	3H41
01:15:21	DP11	CLOC-ONS	3I11E 48TH AV/RIVERA ST,SF
01:15:51	DP11	MISC	3I200, NEED A ROLL CALL FOR WHERE ALL THE UNITS ARE POSITION
01:15:52	DP06	MISC	DO ROLL CALL
01:16:01	DP11	MISC	3X301, NEED A TRACKING DOG
01:16:17	DP02	MISC	MUNI NTFD
01:16:22	DP12	BACK-ENR	3I16E 4T3D:UN
01:16:22	DP12	PERS-ID	4T3D < [REDACTED] PII > FARMER DOUGLAS N/0489
01:16:26	DP11	MISC	3I16E, NEED UNITS AT 47TH AND SANTIAGO
01:16:37	DP11	CLOC-ONS	3H16D 47TH AV/SANTIAGO ST,SF
01:16:41	DP12	BACK-ENR	3I16E 4T3E:UN
01:16:41	DP12	PERS-ID	4T3E < [REDACTED] PII > SMITH THOMAS J/2072
01:16:42	M171	BACK-ENR	3I200 3H13E:P
01:16:42	M171	PERS-ID	3H13E < [REDACTED] PII > CHIN KEVIN K/0188 < [REDACTED] PII > BROWN MICHAEL S/4034
01:16:48	DP02	MISC	311 NTFD
01:16:48	DP06	MISC	3I16D, 47TH/TARAVAL .. TO 47TH/SANTIAGO
01:16:52	DP11	MISC	3I16D, NEED THE UNIT BLOCK 47TH TO SANTIAGO TO BLOCK OFF...3H16D WILL HANDLE
01:16:57	DP12	BACK-ENR	3I16E 4T3I:UN
01:16:57	DP12	PERS-ID	4T3I < [REDACTED] PII > SAWYER JASON C/1127
01:17:10	DP11	CLOC-ONS	3H41 47TH AV/SANTIAGO ST,SF
01:17:11	DP06	CLOC-ONS	3H41 47TH AV/SANTIAGO ST,SF
01:17:23	DP11	MISC	3I16D, NEED A UNIT AT [REDACTED] PII BLK 47TH AV
01:17:29	DP11	BACK-ENR	3H41 3H90C:P
01:17:29	DP11	PERS-ID	3H90C < [REDACTED] PII > COTTER BRIAN C/1603 < [REDACTED] PII > DEELY MICHAEL J/2114
01:17:31	DP11	CLOC-ONS	3H90C 47TH AV/SANTIAGO ST,SF
01:17:53	DP11	MISC	3H11D, [REDACTED] PII 48TH ... SHOTS WHERE FIRED HERE...3SWL166
01:17:57	M436	BACK-ENR	3I16E 3H11E:P
01:17:57	DP02	MISC	US PARK NTFD
01:17:57	M436	PERS-ID	3H11E < [REDACTED] PII > JEFFERSON JASON D/0806 < [REDACTED] PII > MORROW LEONARD C/1196
01:18:02	DP11	CLOC-ONS	3H11D [REDACTED] PII 48TH AV,SF

01:18:07	DP11	CLOC-ONS	3H13D [REDACTED] 48TH AV,SF
01:18:08	M436	ONSCENE	3H11E
01:18:29	DP11	MISC	3I200, REQ'ING A 408...INVOLVED IN A 518/519...47TH AND TARAVAL
01:18:39	DP11	MISC	3I200, ANOTHER 408 TO STANDBY
01:18:48	DP11	MISC	3I200, 1 408 FOR A SFPD UNIT AND 1 408 TO STANDBY
01:19:18	DP06	MISC	410 408'S
01:19:45	DP11	MISC	3I200, HAVE THE 4T UNITS ... 47TH AND TARAVAL...GOT IT PRETTY MUCH LOCKED DOWN
01:19:54	DP01	BACK-ENR	3I16E 3J11E:P
01:19:54	DP01	PERS-ID	3J11E < [REDACTED] >OBRIEN DANIEL P/1427 < [REDACTED] >JUCO GLENN P/4121
01:20:01	DP06	MISC	3H11D, 901 HOSPITAL
01:20:05	DP01	MISC	3I16E, 3J11E@SP89 AND SP84--CAD WILL NOT TAKE THESE ID'S
01:20:13	DP06	BACK-ONS	3I16E 3G2D:P
01:20:13	DP06	PERS-ID	3G2D < [REDACTED] >PETERS ROGER D/0103
01:20:20	DP06	CLOC-ONS	3G2D 46TH AV/TARAVAL ST,SF
01:20:20	DP11	CLOC-ONS	3H11D [REDACTED] 48TH AV,SF
01:20:27	DP11	MISC	3H11D, 901 HOSPITAL...BLOOD ON THE SCENE...MIGHT HAVE BEEN HIT
01:20:37	DP11	MISC	3H11D, CASING HERE AS WELL AT [REDACTED] 48TH AV
01:20:50	DP11	MISC	3H11D, ROUNDS - 9 OR 380
01:20:52	M115	CLEAR	3J11E HAN, SPEC-84/89 RESPONDED AS SPEC CALLSIGN
01:21:05	DP06	BACK-ONS	3I200 SP15:UN
01:21:17	DP06	MISC	3X301, BC'D SUSP DESC
01:21:28	M232	BACK-ENR	3H11D 3A11D:P
01:21:28	M232	PERS-ID	3A11D < [REDACTED] >SOOHOO RANDALL M/2201 [REDACTED] ARTIGA NELSON A/1417
01:21:41	DP11	MISC	3I1D, STILL 97
01:22:03	DP11	MISC	AT SPC78... NEED A SPECIALIST TO SANTIAGO AT 47TH...47TH AND TARAVAL
01:22:10	M278	BACK-ENR	3A11D 3A15:P
01:22:10	M278	PERS-ID	3A15 < [REDACTED] >MATTHEWS KEITH R/0102 < [REDACTED] >OBRIEN WILLIAM S/0119
01:23:01	DP11	MISC	3I200, SP107 97
01:23:09	SU06	MISC	3I16E, *** CHP HELICOPTER UNABLE TO RESPOND TO DUE TO THE WEATHER *** SOME TYPE OF LOW FRONT
01:23:13	DP11	MISC	3I200, SP78 AND SP80 ARE 98...COMPUTER WON'T TAKE ID
01:23:33	DP08	BACK-ENR	3I200 3A14D:P
01:23:33	DP08	PERS-ID	3A14D < [REDACTED] >MORIYAMA GARY J/1791 < [REDACTED] >MALLINGER NOAH D/0116
01:23:47	DP11	MISC	3I16E, LMA, 5-8, 160LBS, SHORT HAIR, DRK BBCAP, WAIST LENGTH DRK JKT...LS RUNNING NB ON 47TH FROM TARAVAL...HE COULDN'T HAVE MADE IT MIDBLOCK
01:24:01	DP08	MISC	3A11D, ALL RESPONDING ON SPEC CALL
01:24:03	DP06	MISC	3H41, POSS SUSP 48TH/SANTIAGO
01:24:04	DP11	CLOC-ONS	3H41 48TH AV/SANTIAGO ST,SF, POSS SUSP
01:24:10	DP11	CLOC-ONS	3H90C 48TH AV/SANTIAGO ST,SF
01:24:33	DP06	MISC	BLU ON BLU
01:24:45	DP11	CLOC-ONS	3H41 [REDACTED] 48TH AV,SF, MIDBLOCK...ENTERED INTO THIS RESIDENCE
01:24:50	DP06	MISC	ENTERED RESIDENCE .. POSS ASIAN MALE
01:25:03	DP11	MISC	3H41, HE MAY HAVE AN ASIAN...DEFINITELY WEARING WAIST LENTH COAT
01:25:14	DP11	MISC	3H41, HE WALKED OUT OF SOME KIND OF AREA JUST WEST OF THIS LOCATION AND THEN WALKED INTO THIS LOCATION
01:25:21	DP11	MISC	3H41, FROM THE GREAT HIGHWAY
01:25:37	DP11	CLOC-ONS	3H41 [REDACTED] 48TH AV,SF, CORRECT 10-20
01:26:15	DP11	MISC	3 SPC GOING TO THAT ADDRESS ON 48TH AV
01:26:20	DP06	MISC	3 SPECS GOING TO ADDRESS
01:26:23	DP11	CLOC-ONS	3H200 [REDACTED] 48TH AV,SF
01:27:04	DP11	MISC	3I200, TRY ANOTHER AGENCY FOR A HELICOPTER
01:27:16	DP11	MISC	TRY SONOMA COUNTY

01:27:27	DP11	MISC	3I200 ADV THAT IT'S CLEAR AND TO TRY ANOTHER COUNTY FOR A HELICOPTER
01:27:33	DP12	MISC	3I200, TRY SONOMA COUNTY...NEED A HELO WITH A FLIR
01:27:50	DP11	MISC	3I200, LOCK DOWN 46TH AND TARAVAL
01:28:05	DP11	MISC	3I5D, HAS 46TH AND TARAVAL
01:28:16	DP06	MISC	ANYONE WATCHING YARDS??
01:28:17	DP11	MISC	BUNCH OF COPS IN THE BACK
01:28:27	DP06	MISC	SOMEONE HAS TO KNOCK ON DOOR
01:28:58	DP11	BACK-ONS	3H110 3H118:S
01:29:18	DP11	MISC	NEED A REVERSE - [REDACTED] 48TH AVE -
01:29:20	DP06	ONSCENE	3H110
01:29:47	DP06	BACK-ENR	3I200 50105:UN
01:29:50	DP11	MISC	NEGATIVE ON [REDACTED] 48TH AVE - NEGATIVE REVERSE
01:29:51	DP12	MISC	NEG ON REVERSE [REDACTED] 48TH AVE
01:30:04	DP11	FNLTYPE	finaltype:418DV-->459
01:30:34	DP11	MISC	3H11E, BLOOD GOING UP THE STAIRS OF [REDACTED] 47TH AV
01:30:37	DP11	CLOC-ONS	3H11E [REDACTED] 47TH AV,SF
01:31:00	DP12	MISC	HAVE BLOOD GOING UP THE STAIRS OF [REDACTED] 47TH AVE
01:31:05	DP11	CLOC-ONS	3H11E [REDACTED] 47TH AV,SF
01:31:55	DP11	MISC	DROP OF BLOOD AT [REDACTED] 47TH AV AND MORE GOING UP THE STAIRS TO THE FRONT DOOR
01:32:02	DP12	MISC	3H110, DROP UNDER THE STAIRWELL AND MORE DROPS GOING UP THE STAIRS OF [REDACTED] 47TH
01:32:35	DP11	BACK-ONS	3I200 3I105:S
01:32:57	DP11	CLOC-ONS	3H13D 47TH AV/SANTIAGO ST,SF
01:33:26	DP02	BACK-ENR	3I105 3E138:S
01:34:32	DP06	MISC	PHONE NUMBER TO [REDACTED] 48TH AVE # [REDACTED]
01:34:42	DP11	MISC	3H118, JUST MADE A 909 WITH 2 PARK RANGERS...JUST SENT THEM UP THE GREAT HWY TO THE BUSHES UP ON THE TOP
01:34:53	DP11	CLOC-ONS	3H90C 48TH AV/SANTIAGO ST,SF
01:35:34	DP11	MISC	CONTACT THE ORIGINAL RP'S HUSBAND AND TO MAKE SURE THAT THE HUSBAND IS OK
01:35:48	DP11	MISC	UNITS AT 47TH/SANTIAGO, MAKE SURE YOU CHECK EVERY CAR
01:36:04	DP06	MISC	3I200, HAVE CERT OFFICER RESP
01:36:38	DP06	MISC	PER CB TO ORIGINAL RP, HUSBAND IS NOT HOME .. BROUGHT DOG HOME, BUT WENT BACK OUT
01:37:14	DP11	CLOC-ONS	3H13D [REDACTED] 47TH AV,SF, BLOOD ON THE STAIRS
01:37:19	DP10	MISC	3H13D, [REDACTED] 47TH AVE WITH BLOOD ON THE STAIRS
01:37:25	DP06	QUERY	[REDACTED] CI
01:37:26	DP02	MISC	OPS CENTER NTFD RE CIRT OFFICER
01:38:18	DP10	MISC	3H13D, 5 HOUSES SOUTH OF SANTIAGO ON THE WESTSIDE
01:38:22	DP06	QUERY	[REDACTED] CI
01:39:13	DP12	BACK-ONS	3I16E SP101:UN
01:39:58	DP10	MISC	3I11E, FOUND FLOOD NORTH OF 47TH HOPPED OVER THE WALL. 3 HOUSES FROM THE CORNER
01:40:21	DP10	MISC	SET UP PERIMETER.. RESPOND TO 48TH/SANTIAGO 47/TAR 48/TAR
01:40:50	DP10	MISC	DOG UNIT AT 48TH/SANTIAGO
01:41:29	DP10	MISC	3H11D, MADE ENTRY WITH BLOOD DROPLETS OPEN BACK DOOR TO THE RESIDENCE
01:41:50	DP10	MISC	RADIO CHANNEL 9 & 10
01:42:29	DP10	MISC	5 GUYS FROM TAC 15 SPECS ARRIVING
01:42:39	DP11	MISC	PER C/B...THE [REDACTED] PII [REDACTED] IS NOW BACK AT HOME AND THE RP ([REDACTED] PII [REDACTED]) WAS ADVISED TO HAVE THE [REDACTED] PII [REDACTED] WAIT FOR PD THERE IF NEEDED
01:43:24	DP10	MISC	NO MORE INDEPENDENT ENTRIES TIL WE GET THIS LOCKED DOWN ..

01:43:32	DP06	BACK-ONS	3I16E SP8:UN, THIS IS SP80
01:43:41	DP06	BACK-ONS	3I16E SP7:UN, THIS IS SP78
01:43:49	DP06	BACK-ONS	3I16E SP9:UN, THIS IS SP89
01:43:59	DP10	MISC	3H11E, WANT TO EXTEND PERIMETER, NORTH OF SANTIAGO
01:44:34	DP06	MISC	3H13D, ADDRESS OF HUSBAND?
01:44:56	DP10	MISC	PERIMETER CAN NOT PASS 47/SANTIAGO 48/SANTIAGO
01:45:32	DP10	MISC	3X301, 4T100 UNIT OUT THERE CAN THEY 904 AT OPERATION COMMAND POST
01:45:53	DP10	MISC	TCP AT [REDACTED] SANTIAGO
01:46:16	DP06	MISC	5O105, MAKING 909
01:46:41	DP06	CLOC-ONS	5O105 [REDACTED] GREAT HY,SF, MAKING 909
01:47:38	DP06	MISC	5O105, NEEDS UNIT TO 904 W/ PIC BATTERY
01:47:53	DP10	MISC	CAR COMING DWON THE STREET AT 47TH/TARAVAL
01:48:26	DP10	MISC	HOUSE WITH THE BLOOD THE BACK DOOR IS OPEN
01:49:09	DP10	MISC	OCP TARAVAL/47TH
01:49:22	DP10	MISC	OCP AT 47TH/TARAVAL
01:49:24	DP11	DSPINFO	3I105 4T7H/TARAVAL *COMMAND POST
01:49:41	M109	BACK-ENR	3I16E 3H12E:P
01:49:41	M109	PERS-ID	3H12E [REDACTED] HERMOSURA JULIAN M/1998 [REDACTED] KAVANAGH JOSEPH D/2133
01:49:49	DP02	MISC	SONOMA COUNTY HELICOPTER OUT OF SERVICE
01:50:08	DP06	PREEMPT	3H12E
01:50:21	DP06	BACK-ENR	5O105 3H12E:P
01:50:21	DP06	PERS-ID	3H12E [REDACTED] HERMOSURA JULIAN M/1998 [REDACTED] KAVANAGH JOSEPH D/2133
01:51:05	DP10	CLOC-ONS	SP101 47TH AV/TARAVAL ST,SF
01:51:29	DP06	BACK-ENR	3I16E SP90:UN
01:51:34	DP10	MISC	3H118, 2 GARAGES AT 48TH FOR TCP
01:51:42	DP02	MISC	OAKLAND HELICOPTER OUT OF SERVICE
01:51:44	DP06	QUERY	[REDACTED] CI
01:51:49	DP06	MISC	SP90, THIS IS SP92
01:52:04	DP10	MISC	GARAGES AT [REDACTED] 48TH AND [REDACTED] 48TH AVE FOR TCP
01:52:53	DP10	MISC	SP101, WILL TRY TO GET A UNIT TO GO SPEAK TO THE [REDACTED]
01:54:11	DP10	MISC	SP101, 47TH/TARAVAL FOR SPECS WHO ARE NOT INV IN A PERIMETER
01:54:44	DP10	MISC	SP101, SEND 2 UNITS TO 47TH/TARVAL TO RELEASE THE SPECIALIST UNITS
01:54:45	DP06	MISC	5O105, MAKE CB FOR [REDACTED] TO COME OUT .. [REDACTED] 98
01:55:59	M323	BACK-ENR	3I16E 3I110:S
01:55:59	M323	PERS-ID	3I110 [REDACTED] WOO HENRY/1556
01:57:32	DP10	MISC	3H11E, [REDACTED] SANTIAGO IS WERE THE BLOOD TRAIL PICKS UP
01:59:39	DP10	MISC	5O105, SPEAKING WITH THE [REDACTED] WITH 5O110
02:01:55	DP10	MISC	SP107, 47TH/TAR MOVING NORTH 47TH AVE STOP AT [REDACTED] 47TH AVE. CHECKING TARAVAL TO SANTIAGO
02:02:34	M109	ONSCENE	3H12E
02:02:37	DP06	MISC	3I200, MOBILE WITH THE 3I105 CHECKING FOR WEAK SPOTS
02:02:50	DP10	MISC	SP101, CODE 33 ON TAC
02:03:18	DP10	MISC	SP101, CODE 33 UNTIL TAC REACH'S DESTINATION
02:03:25	DP12	BACK-ENR	3I16E 3D13E:P
02:03:25	DP12	PERS-ID	3D13E [REDACTED] LOZANO ANGEL G/0554 [REDACTED] FRAIZE MARK W/1986
02:04:42	DP10	MISC	SP101, INTERSECTION ON 47TH STAY BEHIND VEH DOING A SCRIMAGE
02:04:45	DP08	MISC	3A11D, NO 148
02:05:22	DP10	MISC	SP101, MAKE CONTACT WITH PEOPLE.. CHINEASE SPEAKING PEOPLE ONLY IN THE HOUSE
02:05:36	DP10	MISC	SP101, CHINESE SPEAKING OFFICER
02:05:47	DP10	MISC	SP101 [REDACTED] 47TH AVE EAST SIDE OF THE STREET
02:07:13	DP06	CLOC-ONS	3I16D [REDACTED] 46TH AV,SF

02:07:37	DP10	MISC	SP101, STAY OFF 47TH UNITS UNTIL THEY CLEAR SANTIAGO/TARA VAL
02:07:52	DP10	MISC	3H11D, IN THE BACKYARD ON 47TH .. WILL HOLD
02:08:24	DP10	MISC	SP101, CALL OPS NTFY LT TOTA AND CPT MCDUNNA FOR 901
02:10:59	DP10	MISC	SP101, NEGATIVE ON CALL OUT... MGR [REDACTED] ID CALLED OPS
02:13:43	DP06	MISC	3G15E, [REDACTED] PII TARAVAL, 518 POSS 152 ON PERIMETER INVOLVING 3X301'S VEH THAT WAS PARKED AT THE TIME
02:13:56	DP10	MISC	SP101, 2 2 MAN UNITS QUICK CHECK
02:13:59	M109	MISC	3H12E, POSTED MID-BLOCK GREAT HIGHWAY BETWEEN SANTIAGO AND TARAVAL
02:14:07	DP06	MISC	5O105, 459 UPDATED SUSP INFO, 2-3 SUSPS SUSP THAT LEFT SCENE ON THE BIKE POSS WHITE MALE, BLOND/BROWN HAIR, LIGHTER COLORED HAIR, MED HEIGHT AND WEIGHT, ACCOMPANIED WITH ONE OTHER SUSP #2 WMA, MID 20'S, DARK T-SHIRT LIGHT COLORE 5'7-5'10", MED BUILD, POSS BMA INVOLVED
02:14:50	DP06	CLOC-ONS	3G15E [REDACTED] PII TARAVAL ST,SF
02:15:15	DP10	BACK-ENR	3I110 3I90:P
02:16:33	DP10	MISC	SP101, 4 GUYS COMING TO THE BACK
02:16:56	DP11	MISC	3G15E, FOR OFFICER INVOLVED ACCIDENT
02:17:07	DP10	MISC	SP101, SWEEP OF THE BLK HAS BEEN COMPLETED.. BLOOD TRAIL AT SANTIAGO/47TH PASSED THE OBJECTIVE
02:18:02	DP10	CLOC-ONS	[REDACTED] PII 45TH AV/TARAVAL ST,SF
02:18:55	DP06	DUP-OF	[REDACTED] ID
02:19:14	DP10	MISC	SP29, BACK DOOR KICKED IN 6FT FENCE.. POSS CLEAR WITH A DOG ..FRESH KICK.. NABOR OUT OF TOWN
02:20:53	DP06	MISC	3G15E, REQ ACCIDENT TRAINED OFFICER ON AN ALL
02:21:00	DP10	MISC	SP101, REACHED OBJECTIVE FRESH DOOR KICKED IN .. BLOOD PASSED OBJECTIVE.. WILL POSS BE DO A 910 .. 5 HOUSES UP FROM SANTIAGO.. 2 POSIB ONE IN THE HOUSE THE OTHER NEXT TO THE BEACH
02:22:17	DP10	MISC	SP29, DO U WANT US TO WORK OUR WAY IN THE BACKYARD?.. SPLIT 2/2, ONE ON EACH OF THE BACKYARDS
02:22:51	DP06	MISC	3G15E, ALSO REQ 904 TO BREAK DOWN PERIMETER
02:23:30	DP10	MISC	SP101, [REDACTED] PII HAS A FRESH KICKED IN BACK DOOR.. WILL BE TALKING TO 3X301 AND THEN WORKING AFTER THIS OBJECTIVE

CSD

CSD

02:25:48 DP10 MISC SP101, [REDACTED] 47TH AVE HAS THE FRESH KICKED IN BACK DOOR WITH 4 UNITS
IN THE BACK ..
02:26:31 DP11 MISC 3G15E, CORRECTION NOT TO BREAK DOWN PERIMETER UNIT TO COVER
46TH/TARAVAL WHILE UNIT HAN 518 W/ 3X301'S VEH

CSD

CSD

02:27:16	DP06	MISC	3G15E, CORRECTION, UNIT TO 904 AT THE PERIMETER FOR THE 518
02:27:22	DP10	MISC	5O105, SUSP ON THE BIKE IS NON DESCRIPT.. WMA POSS HAD STRAWBERRY BLONDE HAIR POSSIBLY
02:27:50	DP06	CLEAR	3G15E
02:31:27	DP10	BACK-ENR	SP101 4T103:UN
02:31:36	DP10	MISC	4T103, IN THE BACKYARD NEXT DOOR
02:32:24	SU06	BACK-ENR	SP101 2R05:UN
02:34:35	DP10	CLOC-ONS	SP101 [REDACTED] 47TH AV,SF
02:34:42	DP10	CLOC-ONS	SP29 [REDACTED] 47TH AV,SF
02:35:46	DP10	MISC	SP101, NTFY HOSPITALS IF ANY GUN SHOT VICTIM TO NTFY
02:37:02	DP10	MISC	CONTACTED SET EMERGENCY ROOM AND NTFYD TO CONTACT SFPD IF ANY GUN SHOT VICT
02:37:44	SU06	MISC	SP101, ECD1 PAGED - [REDACTED] ID NOTIFIED
02:37:59	DP10	MISC	CONTACTED SFGH EMERGENCY ROOM AND NTFYD TO CONTACT SFPD IF ANY GUN SHOT VICT
02:38:24	DP10	MISC	CONTACTED KASIER EMERGENCY ROOM AND NTFYD TO CONTACT SFPD IF ANY GUN SHOT VICT
02:39:02	DP10	MISC	CONTACTED KASIER SSF EMERGENCY ROOM AND NTFYD TO CONTACT SFPD IF ANY GUN SHOT VICT
02:39:21	M266	QUERY	R 3I200 [REDACTED] PII
02:39:34	DP10	MISC	SP101, [REDACTED] PII 47TH AVE REVERSE
02:40:59	DP10	MISC	SP101, NO PRIORS AT [REDACTED] PII 47TH AVE.. NO REVERSE
02:43:32	DP06	QUERY	Q 3H16D [REDACTED] PII
02:44:07	DP10	MISC	CONTACTED ST LUKES & CPMC EMERGENCY ROOM AND NTFYD TO CONTACT SFPD IF ANY GUN SHOT VICT
02:44:35	DP06	CLEAR	3H16D
02:45:09	DP06	BACK-ONS	3I13E 3H16D:P, CLEARED IN ERROR, ASSISTING 3G15E WITH 518 TOW
02:48:02	DP10	MISC	VEH COMING SOUTH ON 47TH FRM SANTIAGO
02:51:54	DP10	BACK-ENR	SP101 4T201:UN
02:52:12	DP06	CHGLOC	3I11E SFGH
02:55:28	DP10	MISC	SP101, RESIDENCE LOCKDOWN CRIME SCENE DEVELOPED
02:57:12	DP10	MISC	4T201, ***SAFE AVE APPROACH**** WB TARAVAL FROM 46TH
02:57:51	DP10	BACK-ENR	SP101 4T300:UN
02:58:10	DP06	MISC	3H13E, 1/2 OF THE 3H13E STAYING ON RUN .203
02:58:51	DP06	PREEMPT	3H13E
02:59:43	DP10	MISC	4T103, HEADING INTO THE BACKYARD
03:01:34	DP10	MISC	4T103, CLEARED THE COTTAGE AND THE SPACE BEHIND IT AND TO THE NORTH OF IT
03:05:22	DP08	ONSCENE	3A11D, LATE ENTRY
03:05:32	DP08	MISC	3A14D, LATE ENTRY
03:05:40	DP08	ONSCENE	3A14D, LATE ENTRY
03:06:10	DP10	ONSCENE	4T300
03:06:15	DP10	MISC	4T300, AT THE TAC COMMAND
03:07:08	DP10	MISC	3I110, SUSP POSS INJURED MAY POSS BE ON THE BEACH
03:07:43	DP10	MISC	3I110, US PARK POLICE DID SWEEP OF THE BEACH AND THEY ARE STILL 97 WITH SFPD
03:07:51	DP10	MISC	SP101, CODE 33 FOR TAC USE ONLY

03:08:52	DP10	MISC	SP101, KNOCK ON THE RESIDENCE
03:09:37	DP10	MISC	SP101, FRNT DOOR IS SECURE WILL BE USING A PA TO TRY AND WAKE THE 909
03:10:02	DP10	MISC	SP101, SP101 TO 4T103 ITS ALL YOURS
03:11:22	DP10	MISC	SP101, THE WHOLE FRONT IS LIT UP WITH SPOT LIGHTS AND RADIO CARS
03:17:51	M193	BACK-ENR	3H11D 3H16E:P
03:17:51	M193	PERS-ID	3H16E [REDACTED] PII ANDERSON CHRISTOPHER J/0516 [REDACTED] PII >PEDRINI VINCENT M/1222
03:26:05	DP10	MISC	4T103, 4T103 TO TCP CODE 4 HERE
03:26:55	DP10	MISC	SP101, BLOOD TRAIL LEADS TO THE TOP OF THE STAIRS ONE UNIT TO [REDACTED] PII
03:28:28	DP10	MISC	SP101, HOLD PERIMETER.. WILL CHECK THE YARDS [REDACTED] PII 47TH AVE TO SANTIAGO UNIT
03:29:45	DP10	MISC	SP101, RELEASE CODE 33 ON TAC CHANNEL
03:29:57	DP10	CODE-4	SP101, CODE 33 ON TAC CHANNEL
03:31:28	DP10	BACK-ONS	SP101 3I300:S
03:32:31	DP10	MISC	SP101, SP101 TO 4T203 22 THE BACK EVIDENCE SHOWS HE WENT DOWN TO SANTIAGO.. THE BACK DOOR WAS NOT KICKED IN ,JUST LEFT OPEN
03:33:15	DP10	MISC	SP101, END OF THE BLOOD TRAIL RAN UP THE STAIRS AND THEN DOWN TO 5 HOUSES LAST TRAIL OF BLOOD AT 47TH/SANTIAGO
03:33:38	DP10	MISC	SP101, DID SWEEPS IN THE BLK PRIOR, 1 1/2 BLK FROM THE BEACH
03:33:46	DP10	MISC	4T300, HOLD PERIMETER
03:36:01	DP10	MISC	SP101, WALKED THE ESCAPE ROUTE AND LEADS TO 48TH/SANTIAGO ..ITS CLEAR.. WILL WALK 48TH AVE FRM SANTIAGO TWDS TARAVAL
03:37:02	DP10	MISC	SP101, ON 48TH FRM SANTIAGO TWDS TARAVAL WILL DO SCRIMAGE LINE
03:37:10	SU05	MISC	4T300, AREA HOSPITALS NOTIFIED BY SFFD /// INCLUDING SETON
03:39:45	DP10	MISC	SP101, 1 DET POSS UNRELATED ON GREAT HIGHWAY SITTING IN THE YELLOW VAN
03:41:09	DP10	BACK-ENR	SP101 SP23:UN CSD
03:42:33	DP10	MISC	SP101, SUSP GOA SEARCH COMPLETE
03:43:21	DP10	MISC	SP101, WALKTHROUGH COMPLETE ON 48TH BTW SANTIAGO/TARAVAL
03:44:17	DP10	MISC	SP101, HOLD THE PERIMETER
03:44:46	DP10	MISC	3I300, 221 WAS NOT RECOVERED
03:45:37	DP06	MISC	3H13D, BAD PIC BATTERY
03:46:31	DP06	QUERY	Q 3H11D [REDACTED] PII STRUCK BY BULLET, VEH IS BLU IN COLOR
03:46:39	DP06	MISC	3H11D, ** [REDACTED] PII *** STRUCK BY BULLET, VEH IS BLU IN COLOR
03:47:55	DP12	CLEAR	5O105
03:48:21	DP10	REQCC	3I13E [REDACTED] ID assigned
03:48:43	DP10	MISC	3I13E, *****CASE # [REDACTED] ID *****
03:52:46	DP10	BACK-ENR	4T300 5L22:UN
03:55:54	DP10	CODE-4	4T201, PERIMETER CAN BE RELEASED
03:57:07	DP10	MISC	4T201, NEED TARAVAL/RICHMOND UNIT FOR CRIME SCENE
03:58:11	DP10	MISC	4T201, ALL SPECS 904 SP101 AT 47TH/TARAVAL
03:58:26	DP10	MISC	4T72D, CRIME SCENE IS AT [REDACTED] PII SANTIAGO
03:59:15	DP10	MISC	4T201, 4T72E 4T72B 4T72C WILL BE STANDING BY UNTIL RELEASED
03:59:41	DP10	MISC	4T201, 2ND UNIT FOR [REDACTED] PII 47TH AVE
04:00:27	DP10	MISC	4T201, ADV CSI [REDACTED] PII SANTIAGO AND [REDACTED] PII 47TH AVE ARE BLOOD EVIDENCE AND EXPOSED
04:04:10	DP10	CLOC-ONS	3I5D [REDACTED] PII SANTIAGO ST,SF
04:04:40	DP10	CHGLOC	3I16E [REDACTED] PII 47TH AV,SF
04:05:36	DP10	MISC	4T201, TAC BEING RELIEVED AT 3601 SANTIAGO
04:05:42	M193	CLEAR	3H16E HAN
04:09:31	DP06	CLEAR	3H11D HAN

04:09:51	DP10	CLEAR	3H11E HAN
04:09:58	DP10	CLEAR	3H41 HAN
04:10:19	DP10	MISC	3X301, 4T200 CAN PULL OUT THE PERIMETER , AND UNITS GO 10-8
04:10:50	DP10	ONSCENE	3I16D
04:11:05	M413	BACK-ENR	4T201 4T96:UN
04:11:05	M413	PERS-ID	4T96 [REDACTED] PII BYRNE ROBERT W/0828
04:11:37	DP06	CLEAR	3X301 HAN
04:11:45	DP10	CHGLOC	3I1D [REDACTED] PII GREAT HY,SF
04:12:25	DP06	CLEAR	3G2D HAN
04:12:27	DP10	MISC	4T201, RELIEVED OFF OF [REDACTED] PII 47TH AVE
04:13:55	DP06	CLEAR	3H200 HAN
04:13:58	DP06	CLEAR	3H110 HAN
04:16:40	DP10	MISC	4T201, TAC 3 TEAM TO RESPOND BACK TO 47TH/TARAVAL
04:17:31	DP10	MISC	PER CO 1 COMMAND. ALL PERIMETER UNITS MAINTAIN YOUR POSITION
04:18:51	DP10	MISC	TAC UNITS WILL MEET LOWER GREAT AND SANTIAGO AND WILL BE DOING MORE SEARCHING
04:19:07	DP10	MISC	4T201, PARK POLICE 904 AT 47TH/TARAVAL
04:20:07	DP10	MISC	4T201, 410 WITH PARK PD
04:20:38	DP10	MISC	4T201, ALL UNITS 904 AT TARAVAL/LOWER GREAT HIGHWAY
04:24:29	M424	QUERY	[REDACTED] CSD
04:24:53	DP10	MISC	4T201, NTFYD PARK PD TO 904 AT 48TH/TARAVAL
04:27:07	DP11	CLEAR	3H4D
04:28:14	DP10	MISC	SP101, STARTING A GRID SEARCH OF GREAT HIGHWAY AND LOWER HIGHWAY AND BEACH NB/SB ON TARVAL NO CODE 33
04:35:14	M211	MISC	3I5E, CHECKING VEHICLES PARKED ON GREAT HWY
04:35:34	DP10	MISC	4T201, 4201 TO SPC101 PARK PD DID UPPER GREAT HIGHWAY ALL VEH .
04:35:47	DP10	MISC	ONE GUY IN THE BUSHES NEXT TO SANTIAGO
04:36:17	DP10	MISC	RIGHT HEIGHT AND WEIGHT ACTING WEIRD
04:36:25	DP10	MISC	ALL UNITS HOLD POSITION
04:37:06	DP06	MISC	4T300, *** CALL FOLLOWING HOSPITALS AND ASK IF A MALE CAME IN FOR A WOUND THAT NEEDED STITCHES FOR ANY TYPE OF WOUND IN THE LAST HOUR OR SO....HOSPITALS ARE : SETON, SFGH, KAISER SF, KAISER SOUTH, ST LUKES, CPMC
04:37:08	DP10	MISC	SP29, NOT COMING OUT REQ A DOG
04:37:13	DP10	MISC	SP29, DOG UNIT 98
04:37:48	DP10	MISC	SP29, 48TH/SANTIAGO
04:37:56	DP10	MISC	SP29, POSS SUSP IN THE BUSHES
04:38:13	DP10	CLOC-ONS	4T96 48TH AV/SANTIAGO ST,SF
04:38:26	DP10	MISC	SP29, HIT THE PA OR THE DOGS GOING IN
04:38:41	DP10	CLOC-ONS	SP29 48TH AV/SANTIAGO ST,SF
04:39:41	DP10	MISC	SP29, REQ ERIW
04:39:53	DP10	MISC	SP29, DOESNT COME OUT RELEASE THE DOG
04:40:02	DP10	MISC	SP29, RELEASE THE DOG. MALE BEEN SHOT
04:40:34	DP10	MISC	SP29, 40 408 FIRE CAD [REDACTED] ID
04:40:55	DP10	MISC	SP101, 1 DET OUT OF THE BUSHES
04:42:18	DP10	MISC	SP101, LIGHT SKINNED BLK KNIT CAP AND GREY SUIT WITH A WHITE STRIPE WOUND ON HAND
04:42:36	DP10	MISC	SP101, ANY INTIAL OFFICERS THAT CAN IDENTIFY ?
04:43:11	DP06	MISC	4T300, PER SETON - NEGATIVE ON ANYONE WITH STITCHES/WOUND S
04:43:38	DP10	MISC	4T300, HOMICIDE INSPECTORS AND RESPOND DOWN HERE
04:44:26	DP10	MISC	3I91, WIL FOLLOW MEDICS TO THE HOSPITAL
04:45:19	DP10	MISC	SP101, SUSP PULLED OFF JKT BLK JKT , BLK SF BB CAP ON AS WELL PRIOR TO THE DOG GOING IN.
04:45:45	DP10	BACK-ENR	SP101 3I120:S

05:24:26	DP12	ONSCENE	4T72E
05:24:26	DP12	ONSCENE	4T72D
05:24:26	DP12	ONSCENE	4T72A
05:24:26	DP12	ONSCENE	4T3I
05:24:26	DP12	ONSCENE	4T3E
05:24:26	DP12	ONSCENE	4T3D
05:24:26	DP12	ONSCENE	3C115
05:24:26	DP12	ONSCENE	2R05
05:24:26	DP12	ONSCENE	3A15
05:24:26	DP12	ONSCENE	3D13E
05:24:26	DP12	ONSCENE	3E138
05:24:26	DP12	ONSCENE	3I11E
05:24:26	DP12	ONSCENE	3I13D
05:24:26	DP12	ONSCENE	3I16E
05:24:26	DP12	ONSCENE	3I90
05:24:26	DP12	ONSCENE	3I110
05:24:26	DP12	ONSCENE	3I120
05:24:26	DP12	ONSCENE	4T3B
05:27:41	DP10	MISC	SP101, TO PERA - 917 LOWER GREAT NEAR RIVERA
05:28:23	DP10	MISC	SP101, CORRECTION WITH SP35 HAVE 917 LOWER GREAT NEAR RIVERA
05:28:26	DP10	MISC	SP101, CORRECTION WITH SP35 HAVE 917 LOWER GREAT NEAR RIVERA

CSD

05:28:42 DP10 BACK-FNR SP101 SP35:UN

CSD

05:29:07 DP10 MISC 315E, 98 TO GREAT HIWAY/SANTIAGO FOR COLDSHOW

CSD

05:31:36 DP10 MISC SP101, LOWER GREAT, BEACH TO QUINTARA HAS BEEN CHECKED

CSD

CSD

05:33:48	DP10	CHGLOC	3I5E GREAT HIWAY/SANTIAGO FOR COLD SHO
05:36:22	DP10	CHGLOC	3I91 SFGH, FOLLOWING M15
05:44:50	DP10	MISC	4T300, ALL TACHS & SPECIALIST WHO ARENT DIRECTED TO WRITE REPORTS ARE RELEASED
05:45:13	DP10	MISC	3I200, ALL TARAVAL UNITS MAINTAIN THE PERIMETER
05:49:46	DP10	CLEAR	4T300
05:50:05	DP12	CLEAR	3D13E
05:51:06	DP06	CHGLOC	3I11E HOMICIDE
05:54:54	M401	PREEMPT	3C115
05:55:10	DP10	ONSCENE	3I91
06:03:31	DP10	MISC	3I200, CRIME SCENE AT 48TH/SANTIAGO 48TH/GRTHIGHWAY BROKEN DOWN PER HOMICIDE INSPECTOR
06:04:26	DP10	CLOC-ONS	4T72E CO E
06:04:33	DP08	MISC	3A11D, STILL 97
06:04:41	DP10	MISC	3I5E, RUNNING VEH'S IAO
06:04:42	DP08	MISC	3A14D, STILL 97
06:04:49	DP10	PREEMPT	4T201
06:04:58	DP10	CLOC-ONS	4T72D CO E
06:05:23	DP10	CHGLOC	SP101 CO I, THEN 98 TO CO E FOR STATEMENT
06:05:40	DP10	MISC	SP101, CLEAR ALL 4T AND SPECIALIST UNIT
06:09:24	DP10	CLOC-ONS	3I200 [REDACTED] 48THAVE
06:10:18	DP10	MISC	3I1D, CRIME SCENE [REDACTED] GREAT HY HAS BEEN CLEARED & LOGGED
06:10:25	DP10	CHGLOC	3I1D [REDACTED] 48TH AV,SF
06:13:48	DP10	MISC	3I105, TRAFFIC ACCIDENT OFFICER TO RESPOND FOR VEH INTO A HOUSE
06:15:43	M109	CLEAR	3H12E HAN
06:15:58	DP10	MISC	3I105, ON AN ALL FOR TRAFFIC TRAINED OFFICER

CSD

06:21:59	DP08	CLEAR	3A14D HAN
06:22:07	DP08	CLEAR	3A11D HAN

CSD

06:27:20	DP10	CHGLOC	3I200 47TH AV/SANTIAGO ST,SF
----------	------	--------	------------------------------

CSD

06:27:43	DP10	BACK-ENR	3I105 3I10:P
----------	------	----------	--------------

06:27:43 DP10 PERS-ID 3110 < PII > CHAN CHARLES C/1886
CSD

06:30:43 M131 ONSCENE 3110
06:32:08 DP10 BACK-ENR 31105 315:P
06:32:08 DP10 PERS-ID 315 < PII > ADAMSON LORENZO/0416
CSD

06:35:46 M211 CLEAR 315E HAN
06:37:02 DP10 PREEMPT 3110
06:37:55 DP10 BACK-ONS 31120 3110:P
06:37:55 DP10 PERS-ID 3110 < PII > CHAN CHARLES C/1886
06:38:44 DP06 DUP-OF [REDACTED] ID
06:40:29 DP10 MISC 3110, RESPONDED FOR 518 VEH INTO HOUSE CASE # [REDACTED] ID
06:45:47 DP10 CLOC-ONS SP101 CO E
06:50:32 DP10 PREEMPT 3H90C
06:50:41 DP10 PREEMPT 3H118
06:53:10 DP10 PREEMPT 3110
06:54:33 DP10 PREEMPT 3H13D
06:54:53 DP10 BACK-ENR 31120 314:P
06:54:53 DP10 PERS-ID 314 < PII > KING JERRY L/0810
06:55:14 DP06 CLEAR 315D HAN
07:04:47 DP06 CLEAR 31110 HAN
07:12:09 DP06 CLEAR 3H16D HAN
07:17:52 DP06 CLEAR 311D REP. 7E NOW
CSD

07:23:03 DP10 MISC 31200, TARAVAL COMMAND - CHANNEL CLEAR
07:25:12 M122 EMERGENCY 314
07:25:39 DP06 MISC 314, NO EMERGENCY PER UNIT
07:25:45 DP11 MISC 314, NOM TO C33
07:26:31 DP06 BACK-ENR 314 3H7:P
07:26:31 DP06 PERS-ID 3H7 < PII > CURRY RICHMOND E/0585
07:26:40 DP06 CHGLOC 3H7 < PII > 48TH AV,SF, 98 ON THE CRIME SCENE, NTFY TARAVAL 100-UNIT
07:27:16 M122 EMERGENCY 314
07:27:35 DP06 MISC 314, NO EMERGENCY STILL
07:27:40 DP11 MISC 314, NOM AGAIN
07:28:53 DP06 MISC 3H7, 31201 COPIED & WAS THE UNIT WHO SENT 3H7, NTFY TARAVAL
COMMAND, TARAVAL COMMAND COPIES
07:33:04 DP07 CLEAR 3E138
07:53:44 DP11 CLEAR 315

07:54:13	DP06	CHGLOC	3I200 HOJ, RELIEVED FROM CRIME SCENE BY OFCR CURRY OF INGLESIDE STATION
07:58:02	SU06	CLEAR	3I16D
08:05:37	M187	CLEAR	3H7 HAN
08:11:14	DP06	ONSCENE	3I200
08:18:48	DP01	CLEAR	3A15 HAN
08:28:55	DP11	MISC	3I13D, TARAVAL COMMAND IS 7E
08:54:36	DP01	PREEMPT	3I200
08:55:07	DP01	BACK-ENR	3I11E 3I200:S
08:55:07	DP01	PERS-ID	3I200 - [REDACTED] PII - KATO JODY L/0692
09:01:31	DP12	MISC	4T96, MAKE A 901 ON MKT PETS FOOD EXPRESS ..SEE IF THEYR OPEN
09:04:14	DP11	CLEAR	3I4 ADV
09:06:45	DP10	CLEAR	2R05
09:07:55	DP06	ONSCENE	3I11E
09:09:32	DP06	ONSCENE	SP35
09:12:26	DP06	CLEAR	4T72E HAN
09:12:46	DP06	CLEAR	3I91 HAN
09:16:44	DP06	ONSCENE	3I200
09:27:12	DP06	CLEAR	SP7 HAN
09:27:15	DP06	CLEAR	SP8 HAN
09:27:19	DP06	CLEAR	SP9 HAN
09:27:23	DP06	CLEAR	SP15 HAN
09:27:28	DP06	CLEAR	SP23 HAN
09:27:32	DP06	CLEAR	SP29 HAN
09:27:36	DP06	CLEAR	SP35 HAN
09:27:40	DP06	CLEAR	SP90 HAN
09:27:43	DP06	CLEAR	SP101 HAN
09:27:46	DP06	CLEAR	SP107 HAN
09:27:52	DP06	CLEAR	4T3B
09:27:55	DP06	CLEAR	4T3D
09:28:13	DP06	CLEAR	4T3I
09:28:17	DP06	CLEAR	4T3E
09:28:19	DP06	CLEAR	4T72A
09:28:21	DP06	CLEAR	4T72D
09:28:24	DP06	CLEAR	4T96
09:28:26	DP06	CLEAR	4T103
11:05:25	SU06	CLEAR	3I13E
11:05:27	SU06	CLEAR	3I105
11:05:35	SU06	CLEAR	3I300
11:05:37	SU06	CLEAR	3I13D
11:05:40	SU06	CLEAR	3I16E
11:05:42	SU06	CLEAR	3I90
11:05:50	SU06	CLEAR	3I120
11:05:53	SU06	CLEAR	5L22
11:05:59	SU06	CLEAR	3I11E
13:06:57	DP06	CLEAR	3I200
13:06:57	DP06	CLOSE	

Call Recap:

INITIATE: 00:59:50 05/19/2007
ENTRY: 01:02:34 05/19/2007
DISPATCH: 01:03:07 05/19/2007
ON SCENE: 01:07:26 05/19/2007
CLOSE: 13:06:57 05/19/2007
ADDRESS: [REDACTED] PII GREAT HY, SF (D=3I PACHECO ST & QUINTARA ST)
DAREA: 3I
SECTOR: I3
RA: 940
FIRE: 7726

CALL NUMBER: [REDACTED] ID
CURRENT STATUS: CLOSE
PRIMARY UNIT: 3113E
JURISDICTION: SP
DISPOSITION: HAN

REPORT NUMBER: [REDACTED] ID
TYPE: 459 BURGLARY
PRIORITY: A
PRIOR HISTORY: 00

CP: [REDACTED] ID, PI
ADDRESS: [REDACTED]
PHONE: [REDACTED] PII

CAD TIMESTAMP: CADT [REDACTED] ID

OPERATOR ASSIGNMENTS:

	CT14	[REDACTED] PII	ANIANA,ELAINE A
	DP06	[REDACTED]	PONS,MICHAEL G
	M211	[REDACTED]	ROUEDE,ANGELA M
	DP11	[REDACTED]	LEUNG,CYNTHIA J
AS OF 01:07:12	DP06	[REDACTED]	PROCACCINI,JESSICA L
	M250	[REDACTED]	PALMA,MICHAEL A
	DP05	[REDACTED]	HILLCOAST,KAYLEIGH J
	M318	[REDACTED]	LEE,NORMAN S
	M238	[REDACTED]	CALAUNAN,REX F
	M400	[REDACTED]	RADFORD,DAVID C
	M436	[REDACTED]	MORROW,LEONARD C
	M219	[REDACTED]	CHU,THOMAS M
	CT17	[REDACTED]	JANNAH,BINTA M
	M409	[REDACTED]	ODUM,ROBIN L
	DP02	[REDACTED]	CAPARAS,CHARLIE M
	M265	[REDACTED]	WALSH,CARMEN E
	DP12	[REDACTED]	CHACON,STEPHANIE
	DP07	[REDACTED]	FEENEY,LYNN M
	DP01	[REDACTED]	GRANBY,DANA L
	M366	[REDACTED]	OLEARY,SEAN P
	SU06	[REDACTED]	GOLEY,ANNETTE L
	M222	[REDACTED]	LEE,DEAN K
	M284	[REDACTED]	RAMOSO,ARMANN K
	M171	[REDACTED]	CHIN,KEVIN K
	M115	[REDACTED]	OBRIEN,DANIEL P
	M232	[REDACTED]	ARTIGA,NELSON A
	M278	[REDACTED]	O'BRIEN,WILLIAM S
AS OF 01:27:33	DP08	[REDACTED]	DUONG,LINDA
	DP12	[REDACTED]	PONS,MICHAEL G
	DP10	[REDACTED]	ELICETCHE,NATALIE Y
	M109	[REDACTED]	KAVANAGH,JOSEPH D
	M323	[REDACTED]	WOO,HENRY
AS OF 02:02:37	DP06	[REDACTED]	POMEROY,JASMINE M
AS OF 02:04:45	DP08	[REDACTED]	CAPARAS,CHARLIE M
AS OF 02:16:56	DP11	[REDACTED]	GARVEY,CHANTILLY C
	M422	[REDACTED]	MORIYAMA,GARY J

AS OF	ID	PII	NAME
AS OF 02:32:24	SU06		MADSEN, JANICE M
	M266		KATO, JODY L
AS OF 03:05:22	DP08		MARCUCCI, PATRIZIA M
	M193		ANDERSON, CHRISTOPHER J
	SU05		MADSEN, JANICE M
AS OF 03:45:37	DP06		SAN JUAN, JOSEPH B
	M413		BYRNE, ROBERT W
	M424		FRAIZE, MARK W
AS OF 04:27:07	DP11		JANNAH, BINTA M
AS OF 05:01:13	DP12		MADSEN, JANICE M
AS OF 05:03:25	DP06		PAULSEN, DIANE
AS OF 05:17:39	DP10		SAN JUAN, JOSEPH B
AS OF 05:24:26	DP12		RICHARDSON, KELLIE L
	M438		BIGGS, SCOTT B
AS OF 05:36:22	DP10		PONS, MICHAEL G
AS OF 05:50:05	DP12		PROCACCINI, JESSICA L
	M401		BURKE, JOHN F
AS OF 06:03:31	DP10		GARVEY, CHANTILLY C
AS OF 06:04:33	DP08		ANIANA, ELAINE A
	M131		CHAN, CHARLES C
AS OF 06:38:44	DP06		OSORIO, CATHY
AS OF 07:12:09	DP06		CAMPBELL, CONNIE
AS OF 07:17:52	DP06		OREILLY-JACKSON, LAURA K
AS OF 07:19:02	DP10		DOUGHERTY, KIM M
	M122		KING, JERRY L
AS OF 07:25:45	DP11		BUFFINGTON, CAROL A
AS OF 07:33:04	DP07		GONZALEZ, DORA M
AS OF 07:53:44	DP11		MACKIEWICZ, FIATAMALII N
AS OF 07:58:02	SU06		DOUGHERTY, KIM M
	M187		CURRY, RICHMOND E
AS OF 08:18:48	DP01		RAGLER, JUANITA A
AS OF 09:01:31	DP12		ALEMU, HIRUT
AS OF 09:04:14	DP11		CAMPBELL, CONNIE
AS OF 09:06:45	DP10		SELINGER, JANET L
AS OF 09:07:55	DP06		RICHARDSON, KELLIE L
AS OF 13:06:57	DP06		FLANNERY, FRANCES D

CONFIDENTIAL

FROM: CABLE ISN: 00704 DATE: 08/18/08 TIME: 13:30:53 ADMIN MSG
TO: CTA0X003 OSN: 00116 DATE: 08/18/08 TIME: 13:30:54

[REDACTED] ID SAN FRANCISCO POLICE DEPARTMENT ASSIGNED TO:
HOMICIDE
COMPNO: [REDACTED] ID INITIAL INCIDENT REPORT

ATTEMPTED HOMICIDE WITH A GUN CODE: 04021
AGGRAVATED ASSAULT ON POLICE OFFICER WITH A GUN CODE: 04071
POSS OF FIREARM BY CONVICTED FELON/ADDICT/ALIEN CODE: 12080

TIME OF OCCURRENCE: SAT 05/19/07 0100HRS
LOCATION OF OCCURRENCE: [REDACTED] PII UPPER GREAT HY
LOCATION SENT TO: 48TH AV/TARAVAL ST UNIT REPORTING: 3113E
DISTRICT OF OCCURRENCE: TARAVAL REPORTING AREA: 940
TYPE PREMISE: APARTMENT

REPORTED TO POLICE: SAT 05/19/07 0102
REPORTED TO BUREAU: SAT 05/19/07 0109
ENTERED INTO COMP : THU 05/24/07 0847 ENTERED BY: KM

VICTIM-1(ALSO REPORTEE): [REDACTED] ID, PII
RES. ADDRESS: [REDACTED] PII RES. PHONE: [REDACTED] PII
NIGHT PHONE: [REDACTED] PII
BUS. ADDRESS: [REDACTED] PII
NIGHT PHONE: CELL // FUF/STATEMENT: YES // RELATIONSHIP TO SUBJECT:
UNKNOWN

REPORTEE-1(ALSO WITNESS): [REDACTED] ID, PII
RES. ADDRESS: [REDACTED] PII RES. PHONE: [REDACTED] PII
BUS. ADDRESS: [REDACTED] PII BUS. PHONE: [REDACTED] PII
CELL # [REDACTED] PII // FUF/STATEMENT: YES // RELATIONSHIP TO
SUBJECT: STRANGER/NONE

REPORTEE-2(ALSO WITNESS): [REDACTED] ID
RES. ADDRESS: [REDACTED] PII RES. PHONE: [REDACTED] PII
BUS. ADDRESS: [REDACTED] PII BUS. PHONE: [REDACTED] PII

CONFIDENTIAL

SUSPECT-1(BOOKED): [REDACTED] ID, PII

5'07" 145 LBS HAIR: BLACK EYES: BROWN

RES. ADDRESS: NO LOCAL

SOCSEC: [REDACTED] PII SFNO: [REDACTED] PII

CIINO: [REDACTED] PII FBINO: [REDACTED] PII

BOOKING APPROVAL:GAYNOR/INS/1524

SECTION VIOLATED: NW 664/187PC

SECTION VIOLATED: NW 664/187PC

SECTION VIOLATED: NW 459 PC

SECTION VIOLATED: NW 12021A PC

SECTION VIOLATED: NW 245D 2CTS

SECTION VIOLATED: NW 459 PC

SECTION VIOLATED: NW 496A PC

SECTION VIOLATED: 12031A 1 PC

SECTION VIOLATED: 12025A 2 PC

BOOKED AT CJ #9

SUSPECT-2: NO/NAME W/M

RES. ADDRESS: UNKNOWN

5'08"-6'00" TALL, MEDIUM BUILD, LIGHT HAIR BLONDE OR STRAWBERRY
BLONDE, UNKNOWN CLOTHING

* NARRATIVE PURGED - CONTACT RECORD ROOM FOR COMPLETE REPORT *

REPORTING OFFICER(S): PALMA/MICHAEL/A/PTL/841

APPROVED BY: OLEARY/LT/1892 ASSIGNED BY: KATO/SGT/692 05/24/07/0903

(CONT)

TYPE CLEARANCE: ARREST, BOOKED

END OF INCIDENT REPORT [REDACTED] ID

SAN FRANCISCO POLICE DEPARTMENT

STATUS OF INQUIRY ON CASE NUMBER [REDACTED] ID

INCIDENT REPORT

ALREADY SENT TO TERMINAL

INCIDENT [REDACTED]

EVIDENCE INVENTORY (FOR C.S.I. USE ONLY)

CRIME SCENE INVESTIGATIONS UNIT

STATUS CODES: B BOOKED F FREEZER D DRYING P TO BE PROCESSED + USABLE LATENTS -- NO USABLE PRINTS

1.	.40 cal shell casing, [REDACTED] LEI	[REDACTED] PII	block 48 th Ave. in street	986	b	5/20/07	N/A
2.	.40 cal shell casing	[REDACTED]	block 48 th Ave. in street	986	b	5/20/07	N/A
3.	.40 cal shell casing	[REDACTED]	block 48 th Ave. in street	986	b	5/20/07	N/A
4.	.40 cal shell casing	[REDACTED]	block 48 th Ave. in street	986	b	5/20/07	N/A
5.	Bracelet	[REDACTED]	block 48 th Ave. in street	986	b	5/20/07	N/A
6.	.40 cal shell casing [REDACTED] LEI	[REDACTED]	block 48 th Ave. in street	986	b	5/20/07	N/A
7.	.40 cal shell casing	[REDACTED]	block 48 th Ave. in street	986	b	5/20/07	N/A
8.	.40 cal shell casing	[REDACTED]	block 48 th Ave. in street	986	b	5/20/07	N/A
9.	Floor plate of magazine	[REDACTED]	block 48 th Ave. in street	986	p/b	5/20/07	-
10.	Spring from magazine	[REDACTED]	block 48 th Ave. in street	986	b	5/20/07	N/A
11.	Number not used missing						
12.	Number not used missing						

CHAIN OF CUSTODY

item # (s)	description	relinquished by	received by	date	time
					hrs.
					hrs.
					hrs.
					hrs.

ID [REDACTED]

CSI 2

INCIDENT [REDACTED] **EVIDENCE INVENTORY (FOR C.S.I. USE ONLY)** [REDACTED]
CRIME SCENE INVESTIGATIONS UNIT

STATUS CODES: **B** BOOKED **F** FREEZER **D** DRYING **P** TO BE PROCESSED **+** USABLE LATENTS **--** NO USABLE PRINTS

13.	Bullet	[REDACTED] PII	block 48 th Ave. in the street	986	B	5/20/07	N/A
14.	Holster, broken magazine, 14 9mm rounds, 12 R/P, 2 Win, & small pieces of lead	[REDACTED]	block 48 th Ave. in the street	986	P/B	5/20/07	-
15.	9 mm shell r/p	[REDACTED]	block 48 th Ave. in the street	986	P/B	5/20/07	-
16.	9 mm shell r/p	[REDACTED]	block 48 th Ave. in the street	986	P/B	5/20/07	-
17.	9 mm shell [REDACTED] LEI	[REDACTED]	block 48 th Ave. in the street	986	P/B	5/20/07	-
18.	9 mm shell r/p	[REDACTED]	block 48 th Ave. in the street	986	P/B	5/20/07	-
19.	9 mm shell r/p	[REDACTED]	block 48 th Ave. in the street	986	P/B	5/20/07	-
20.	9 mm shell r/p	[REDACTED]	block 48 th Ave., on sidewalk	986	P/B	5/20/07	-
21.	Bullet jacket	[REDACTED]	block 48 th Ave. in the street	986	B	5/20/07	N/A
22.	9 mm shell [REDACTED] LEI	[REDACTED]	block 48 th Ave., on sidewalk	986	P/B	5/20/07	-
23.	9 mm shell [REDACTED]	[REDACTED]	block 48 th Ave., on sidewalk	986	P/B	5/20/07	-

CHAIN OF CUSTODY

ITEM # (s)	DESCRIPTION	RELINQUISHED BY	RECEIVED BY	DATE	TIME
					HRS.
					HRS.
					HRS.
					HRS.

INCIDENT [REDACTED] **EVIDENCE INVENTORY (FOR C.S.I. USE ONLY)** [REDACTED]
CRIME SCENE INVESTIGATIONS UNIT

STATUS CODES: B BOOKED F FREEZER D DRYING P TO BE PROCESSED + USABLE LATENTS -- NO USABLE PRINTS

24.	9 mm shell [REDACTED] LEI	[REDACTED] PII	block 48 Ave sidewalk	986	P/B	5/20/07	-
25.	9 mm shell R/P	[REDACTED]	block 48 Ave street	986	P/B	5/20/07	-
26.	9 mm shell R/P	[REDACTED]	block 48 Ave street	986	P/B	5/20/07	-
27.	9 mm shell [REDACTED] LEI	[REDACTED]	block 48 Ave sidewalk	986	P/B	5/20/07	-
28.	Blood sample, control, water	[REDACTED]	block 48 Ave sidewalk	986	P/B	5/19/07	N/A
29.	Bike Green Kore GB11121	[REDACTED]	block 48 Ave sidewalk	986	P/B	5/20/07	+
30.	Metal jacket from bullet	[REDACTED]	block 48 Ave sidewalk	986	P/B	5/20/07	N/A
31.	Metal jacket from bullet	[REDACTED]	block 48 Ave street	986	P/B	5/20/07	N/A
32.	Blood sample, control, water	[REDACTED] PII	Behind right front door of green van	986	D/B/F	5/19/07	N/A
33.	One Beretta 92 FS 9mm	[REDACTED]	Bushes Great Hwy & Santiago St.	986	P/B	5/20/07	-
34.	One baseball cap "SF" on front	[REDACTED]	Bushes Great Hwy & Santiago St.	986	B	5/20/07	N/A
35.	One black jacket	[REDACTED]	Bushes Great Hwy & Santiago St.	986	B	5/20/07	N/A

CHAIN OF CUSTODY

ITEM # (s)	DESCRIPTION	RELINQUISHED BY	RECEIVED BY	DATE	TIME
					HRS.
					HRS.
					HRS.
					HRS.

CSI 4

PII	CRIME SCENE INVESTIGATIONS LATENT FINGERPRINT REQUEST / REPORT					DATE / TIME RECEIVED hrs.	
						DATE / TIME REQUESTED hrs.	
ID	OFFENSE 217	ARREST MADE <input checked="" type="checkbox"/>	REQ BY GAYNOR	STAR 1524	UNIT 5H	N/R CARD LEFT <input type="checkbox"/>	DATE/TIME hrs.
	COMPLAINANT SFPD					RUNDATE 5/19/07	ARRIVAL TIME 03:24 Hrs.
	LOCATION OF RUN PII Block 48 th Ave.					CSO/STAR S. GREGORY #986	PII
REMARKS / INSTRUCTIONS Sweeney #605, Schmidt #1334, Phillips# 1637					CSO/STAR		

VEHICLE PROCESSED	YEAR	MAKE	MODEL	COLOR	LICENSE	VIN.
-------------------	------	------	-------	-------	---------	------

RESULTS OF INVESTIGATION (C.S.I. USE ONLY)

PHOTOS	NO <input type="checkbox"/>	YES: BY C.S.O. <input type="checkbox"/>	BY PHOTO LAB <input checked="" type="checkbox"/>	PHOTO ONLY ASSIGNMENT/SEE "QPIX" <input type="checkbox"/>
PRINTS	NO: PROC WITH NEG RESULTS <input type="checkbox"/>			NOT PROCESSED <input type="checkbox"/>
	YES: FROM SCENE <input checked="" type="checkbox"/>			FROM EVIDENCE <input type="checkbox"/>
COMMENTS/POE		Prints are from the bike and are not afis quality		

PROPERTY PROCESSING REQUEST

LOCATION: Property Clerk <input type="checkbox"/>	Crime Lab <input type="checkbox"/>	Hand Delivered <input type="checkbox"/>	By	Star #	Rec'd by
ITEM	Bagno.	Bagtype	Stored in	Location	

FINGERPRINT EXAMINATION REQUEST

SERVICE REQUESTED (CHECK BOX) <input type="checkbox"/> CONDUCT AREA SEARCH FROM (DATE) TO	
<input type="checkbox"/> SEARCH LATENTS IN A.F.I.S. PLOT #S	
<input checked="" type="checkbox"/> COMPARE LATENTS WITH BELOW LISTED SUBJECTS:	
LAST NAME/ FIRST/ M.I.	S.F. #
1. ID	PII
ID	
2.	
3.	
4.	
RESULTS OF EXAMINATION (C.S.I. USE ONLY)	
I.D. <input type="checkbox"/>	
NEG <input checked="" type="checkbox"/>	
I.D. <input type="checkbox"/>	
NEG <input type="checkbox"/>	
I.D. <input type="checkbox"/>	
NEG <input type="checkbox"/>	
I.D. <input type="checkbox"/>	
NEG <input checked="" type="checkbox"/>	
EXAMINER: PII DATE 5.22.07 LIFTBY 1334	
CONFIRMED BY: PII DATE 5.22.07	

OR CSI OFFICE USE ONLY

CSI 1

SFDPA - 0662-08 - 000065

INCIDENT [REDACTED] ID [REDACTED] **EVIDENCE INVENTORY (FOR C.S.I. USE ONLY)** [REDACTED] PII [REDACTED] 982
CRIME SCENE INVESTIGATIONS UNIT

STATUS CODES: B BOOKED F FREEZER D DRYING P TO BE PROCESSED + USABLE LATENTS -- NO USABLE PRINTS

36.	2 shoes	[REDACTED] ID	Moriyama # 1791	986	B	5/19/07	N/A
37.	One green jacket	[REDACTED] ID	Moriyama # 1791	986	B	5/19/07	N/A
38.	One green pants	[REDACTED] ID	Moriyama # 1791	986	B	5/19/07	N/A
39.	One gray t-shirt	[REDACTED] ID	Moriyama # 1791	986	B	5/19/07	N/A
40.	Red bandana	[REDACTED] ID	Moriyama # 1791	986	B	5/19/07	N/A
41.	One cell phone and charger, 5 keys on a ring with flashlight, battery, Misc. cards & holder, pen, lighter, one pair of glasses and a comb	from black jacket item #35 [REDACTED] ID [REDACTED] ID	Moriyama # 1791	986	B	5/19/07	N/A
42.	One piece of lead bullet	Street in front of [REDACTED] PII	48 th Ave.	605	B	5/20/07	N/A
43.	One handwritten note	Left pocket of item 37		1334/986	B	5/20/07	N/A
44.	3 fraudulent 100 dollar bills	Left pocket of item 37		1334/986	B	5/20/07	N/A
45.	GSR test	From hands of [REDACTED] ID		986	b	5/19/07	N/A

CHAIN OF CUSTODY

ITEM # (s)	DESCRIPTION	RELINQUISHED BY	RECEIVED BY	DATE	TIME
					HRS.
					HRS.
					HRS.
					HRS.

CSI 5

ID
05/19/07 03:24 Hrs.
PII Block 48th Ave.
Shooting PII
S. Gregory # 986 PII
Not to Scale
Numbers items of Evidence
Street lights= Ø

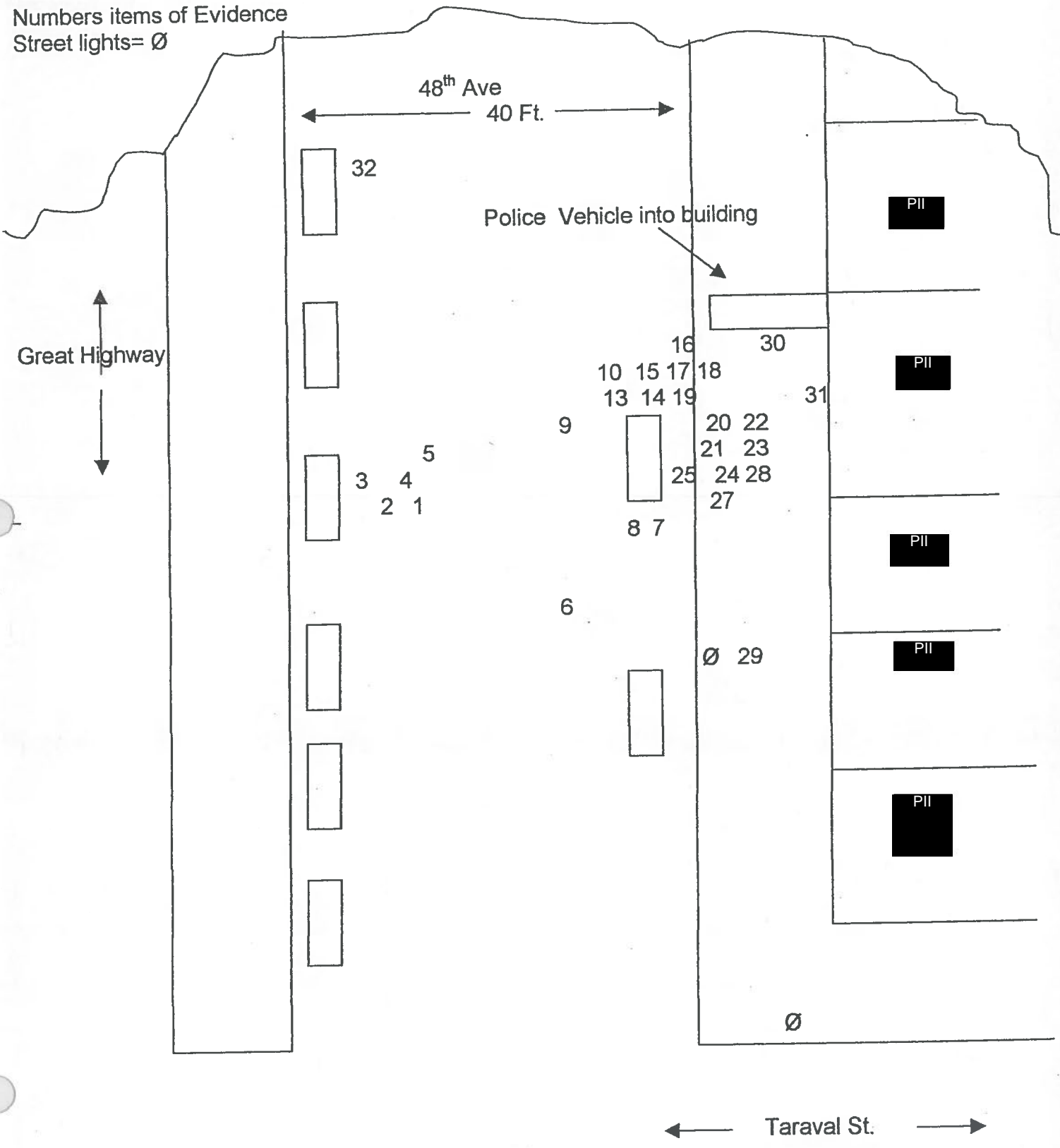

CSI 6

San Francisco Police Department Crime Scene Report

Case #: [REDACTED] ID [REDACTED]

Date: 05/20/07

Time: 03:24

Location: [REDACTED] PII block 48th Ave.

Name: S. Gregory #986 [REDACTED] PII 7/9/07

Purpose:

I was sent to the [REDACTED] PII block of 48th Ave. to investigate a shooting between a police officer and a burglary suspect. Once there I was met by Capt. Titel # 2104, who told me that two Officers were driving north on 48th Ave. in a marked police car when they spotted a burglary suspect who was riding a bicycle south on 48th Ave. The passenger officer got out of the vehicle to stop the suspect and the suspect rode his bike up onto the sidewalk to avoid the officers. The suspect then started shooting at the officers and hitting the police vehicle three times around the right front passenger door. The passenger officer returned fire and shots were exchanged between one officer and the suspect. The suspect was able to flee south on 48th Ave. and east on Taraval St.

Scene Description:

At the time that I arrived it was dark and the main source of light was streetlights in the area. The weather was clear at ground level and very cool with moist air from the ocean, which was only across the Great Highway. The actual shooting occurred in front of [REDACTED] PII and [REDACTED] PII 48th Ave. where the police vehicle had driven into the driveway and came to rest in front of [REDACTED] PII 48th Ave, after striking the building head on. I could see what looked like three bullet holes into the front right door of the vehicle and there was damage to the right outside rearview mirror. A green Nissan van (Calif. Lic. # [REDACTED] PII) was parked facing north in front on the same building. Shell casings littered the area around the van, with 9mm shell casings found in the area in front of the van and on the sidewalk next to the van. Forty Cal. shell casings were found to the rear of the van and on the opposite side of the

CSI 7

street. The rear window of the van and the right rear window had been completely shot out. The left rear tire was flat and the left front door had a bullet hole near the bottom, going into it. The right front window had been struck by one bullet and the cone pattern on the inside of the glass indicated the bullet came from the outside of the van on the sidewalk. Above the same window can be seen an oblong channel in the metal of the roof that starts out as a shallow groove and spreads out and goes deeper into the metal until it comes to an abrupt end. This is where a bullet coming from the area of the sidewalk ricocheted off the vehicle. Also on the right front door was a thin line of blood that was running down the side of the door. A few feet away on the sidewalk were several drops of blood, which is the beginning of a trail of blood that can be followed south on 48th Ave. to Taraval St. and east on Taraval St. to 47th Ave., and then north on 47th Ave. to the intersection of 47th Ave. and Santiago St. The last signs of blood were found on the front side of the building at [PII] Santiago St.

Other items found in the area were the bike left by the suspect and a holster that had a pouch for an extra magazine in front of it. The magazine in the pouch was damaged and may have been struck by a bullet. The floor plate of the magazine and the spring was found in front of the van on the street (items 9 and 10 in the drawing). The magazine still had the follower and 14 9 mm rounds in it along with some small shavings of lead that were found in the magazine pouch of the holster. There was also damage to the garage door on [PII] 48th Ave. about an inch from the bottom where a bullet entered and was lodged in the wood. This bullet came from the street and was not removed at this time because of the damage removing it would do to the garage door.

While working on the scene I was called to the intersection of Great Highway and Santiago St. to do a GSR test on a suspect who had been taken into custody at the location. An Officer using a dog had located [ID] [ID] hiding in the bushes; [ID] had refused to come out of the bushes and had been bitten by a police dog prior to being brought out of the bushes by the officers. At the time I did the GSR test, [ID] was in an ambulance. He had blood on both hands and both hands were dirty and had sand on them. A Beretta 92 FS was also located in the bushes where [ID] was found. After the area was photographed I collected the gun.

Evidence:

[PII] 99

CSI 9

While I collected all the evidence at the main scene and booked it, later several officers from the CSI unit also arrived and collected evidence or helped with packaging at a later time. Inspector Gee # 574 processed the original burglary scene. Officer Sweeney # 605 arrived and collected samples of the blood trail from 48th Ave. and Taraval St. and east on Taraval St. to 47th Ave., and then north on 47th Ave. to the intersection of 47th Ave. and Santiago St. Inspector Ganster # 1830, Officers Schmidt #1334 and Phillips #1637 also arrived and tried to develop a print on a painted stucco wall on the outside wall of the stairway at [PII] 47th Ave. This was done with negative results. A search of the of the area from [PII] Santiago St. west to where [ID] was found in bushes on the Great Highway was made by Officers Schmidt and Phillips looking for any signs of a blood trail that might have been missed at night. This search produced negative results.

D.A Eliot Beckleman called me after I left the scene and told me he had been listening to the interviews with the Officers involved and that they had mentioned seeing flashes on the street as if bullets had ricocheted off the street. He asked if I had any bullet fragments. I told him that I did have some, and he asked me to go back to the scene and see if I could locate more. I did return to the scene right away with Inspector Ganster, Officers Schmidt, Sweeney and Phillips. We made a second search of the scene and extended that search out even farther and located one piece of lead in front of [PII] 48th Ave. near the west curb. We also located possible damage to the front of the building that may have been made by bullets near the north side drain pipe about 7 feet up the wall.

Later the same morning Inspector Gaynor #1524 called me asked that we go back to Taraval St. between 48th Ave. and 47th Ave. and search the sidewalk and street on the north of Taraval St looking for a 40 Cal cartridge that one of the officers may have ejected from his gun. This search was made right away by officer Sweeney and Schmidt with negative results.

On Sunday morning 5/20/07 at about 7:30 I was contacted by Inspector Gaynor. He asked that we make a further search of the 47th Ave. and Santiago St for any more signs of blood. All the previous officers responded and we extended the search by one block in each direction going north on 47th Ave. to Rivera St. and east on Santiago St one block with negative results.

[PII] 10

Measurements for items in drawing:

Number	Item	Measured from Taraval St.	Measured from the east curb of 48 th Ave..
1.	40 Cal. Shell	75 Ft. 2ins.	26 Ft.
2.	40 Cal. Shell	75 Ft. 9ins.	29 Ft.
3.	40 Cal. Shell	77 Ft. 10 ins.	30 Ft. 10 ins.
4.	40 Cal. Shell	78 Ft. 8 ins.	28 Ft. 3 ins
5.	Bracelet	80 Ft. 1 ins.	27 Ft. 9 ins.
6.	40 Cal. Shell	68 Ft. 1 ins.	9 Ft. 9 ins.
7.	40 Cal. Shell	67 Ft. 9 ins.	2 Ft. 7 ins.
8.	40 Cal. Shell	72 Ft. 10 ins.	6 Ft. 8 ins.
9.	Magazine spring	90 Ft. 6 ins.	
10.	Floor plate of magazine	100 Ft. 2 ins.	105 Ft.
11.	Number Not used		
12.	Not used		
13.	Bullet	95 Ft.	5 Ft. 9 ins.
14.	Holster	97 Ft. 3 ins.	4 Ft.
15.	9 mm shell	99 Ft. 7 ins.	2 Ft. 5 ins.
16.	9 mm shell	100 Ft. 5 ins.	Curb
17.	9 mm shell	99 Ft. 7 ins.	Curb
18.	9 mm shell	99 Ft. 3 ins.	5 ins.
19.	9 mm shell	94 Ft. 2 ins.	3 ins.
20.	9 mm shell	9 Ft.3 ins.	7 ins.
21.	Metal jacket	91 Ft. 4	9 ins.
22.	9 mm shell	92 Ft.	3 Ft. 9 ins.
23.	9 mm shell	89 Ft. 3 ins.	3 Ft. 10 ins.
24.	9 mm shell	87 Ft. 9 ins.	8 ins.
25.	9 mm shell	87 Ft. 2 ins.	8 ins.
26.	9 mm shell	87 Ft. 2 ins.	1 Ft. 1 ins.
27.	9 mm shell	82 Ft. 9 ins.	1 Ft. 9 ins.
28.	Blood	85 Ft. 8 ins.	1 Ft.
29.	Bike	61 Ft. 10 ins.	7 Ft. 2 ins.
30.	Bullet	105 Ft. 6 ins.	6 Ft. 5 ins.
31.	Metal fragment	95 Ft. 1 ins.	16 Ft.
32.	Metal jacket	122 Ft.	

P11

CSL 16

CASE #	CRIME SCENE INVESTIGATIONS LATENT FINGERPRINT REQUEST / REPORT					DATE / TIME RECEIVED hrs.	
						DATE / TIME REQUESTED hrs.	
	OFFENSE Officer Involved Shooting	ARREST MADE <input checked="" type="checkbox"/>	REQ BY GAYNOR	STAR 1524	UNIT 5H17	N/R CARD LEFT <input type="checkbox"/>	DATE/TIME hrs.
	COMPLAINANT S.F.P.D.					ROUND DATE 5/19/07	ARRIVAL TIME 05:00 Hrs.
	LOCATION OF RUN PII Great Highway					CSO / STAR R. GEE	#574
REMARKS / INSTRUCTIONS					CSO / STAR		

VEHICLE PROCESSED	YEAR	MAKE	MODEL	COLOR	LICENSE	VIN.
-------------------	------	------	-------	-------	---------	------

RESULTS OF INVESTIGATION (C.S.I. USE ONLY)

PHOTOS	NO <input type="checkbox"/>	YES: BY C.S.O. <input type="checkbox"/>	BY PHOTO LAB <input checked="" type="checkbox"/>	PHOTO ONLY ASSIGNMENT/SEE "QPIX" <input type="checkbox"/>
PRINTS	NO: PROC WITH NEG RESULTS <input checked="" type="checkbox"/>			NOT PROCESSED <input type="checkbox"/>
	YES: FROM SCENE <input type="checkbox"/>			FROM EVIDENCE <input type="checkbox"/>
COMMENTS/POE	Processed three vehicles in garage for prints. CA: PII, CA: PII, CA: PII			

PROPERTY PROCESSING REQUEST

LOCATION: Property Clerk <input type="checkbox"/>	Crime Lab <input type="checkbox"/>	Hand Delivered <input type="checkbox"/>	By	Star #	Rec'd by
ITEM	Bagno.	Bagtype	Stored in	Location	

FINGERPRINT EXAMINATION REQUEST

SERVICE REQUESTED (CHECK BOX) <input type="checkbox"/> CONDUCT AREA SEARCH FROM (DATE) TO	
<input type="checkbox"/> SEARCH LATENTS IN A.F.I.S. PLOT #S	
<input type="checkbox"/> COMPARE LATENTS WITH BELOW LISTED SUBJECTS:	
LAST NAME / FIRST / M.I.	S.F. #
1.	RESULTS OF EXAMINATION (C.S.I. USE ONLY)
	I.D. <input type="checkbox"/>
	NEG <input type="checkbox"/>
2.	I.D. <input type="checkbox"/>
	NEG <input type="checkbox"/>
3.	I.D. <input type="checkbox"/>
	NEG <input type="checkbox"/>
4.	I.D. <input type="checkbox"/>
	NEG <input type="checkbox"/>
EXAMINER DATE LIFTBY	
CONFIRMED BY DATE	

FOR CSI OFFICE USE ONLY

CASE #	ID				CRIME SCENE INVESTIGATIONS		DATE / TIME RECEIVED	
	LATENT FINGERPRINT REQUEST / REPORT						DATE / TIME REQUESTED	
	OFFENSE 217		ARREST MADE <input checked="" type="checkbox"/>		REQ BY		STAR UNIT	
	COMPLAINANT S.F.P.D.				PHONE		N/R CARD LEFT <input type="checkbox"/>	
	LOCATION OF RUN [PII] BLK OF 48TH AVE.						RUNDATA 5-19-07 @ 0601	
REMARKS/INSTRUCTIONS						ARRIVAL TIME CSO/ STAR SWEENEY - 605		
						C.S.O/ STAR		

VEHICLE PROCESSED	YEAR	MAKE	MODEL	COLOR	LICENSE	VIN.
-------------------	------	------	-------	-------	---------	------

RESULTS OF INVESTIGATION (C.S.I. USE ONLY)

PHOTOS	NO <input type="checkbox"/>	YES: BY C.S.O. <input checked="" type="checkbox"/>	BY PHOTO LAB <input type="checkbox"/>	PHOTO ONLY ASSIGNMENT/SEE "QPIX" <input type="checkbox"/>
PRINTS	NO : PROC WITH NEG RESULTS <input checked="" type="checkbox"/>		NOT PROCESSED <input type="checkbox"/>	
	YES : FROM SCENE <input type="checkbox"/>		FROM EVIDENCE <input type="checkbox"/>	
SEE INVENTORY FOR PROCESSED EVIDENCE	<input type="checkbox"/>			
COMMENTS/ POE	OFFICER - INVOLVED SHOOTING			

PROPERTY PROCESSING REQUEST

LOCATION: Property Clerk <input type="checkbox"/>	Crime Lab <input type="checkbox"/>	Hand Delivered <input type="checkbox"/>	by	Star#	Rec'd by
ITEM	Bagno.	Bagtype	Stored in	Location	

FINGERPRINT EXAMINATION REQUEST

SERVICE REQUESTED (CHECK BOX)		<input type="checkbox"/> CONDUCT AREA SEARCH FROM (DATE) _____ TO _____	
<input type="checkbox"/> SEARCH LATENTS IN A.F.I.S		PLOT #'S _____	
<input type="checkbox"/> COMPARE LATENTS WITH BELOW LISTED SUBJECTS: _____			
LAST NAME/ FIRST/ M.I.	S.F. #	RESULTS OF EXAMINATION (C.S.I. USE ONLY)	
1		I.D. <input type="checkbox"/>	
		NEG <input type="checkbox"/>	
2		I.D. <input type="checkbox"/>	
		NEG <input type="checkbox"/>	
3		I.D. <input type="checkbox"/>	
		NEG <input type="checkbox"/>	
		I.D. <input type="checkbox"/>	
		NEG <input type="checkbox"/>	
EXAMINER _____		DATE _____	LIFTBY _____
CONFIRMED BY _____		DATE _____	

FOR CSI OFFICE USE ONLY

INCIDENT #

ID

EVIDENCE INVENTORY (FOR C.S.I. USE ONLY)
CRIME SCENE INVESTIGATIONS UNIT

STATUS CODES: B BOOKED F FREEZER D DRYING P TO BE PROCESSED + USABLE LATENTS - NO USABLE PRINTS

#	ITEM	LOCATION FOUND	COLLECTED REC'D FROM	INITIAL STATUS	DATE BOOKED	LATENTS + - n/a
1	(2) SWABS, POSS. BLOOD / @ CONE (A)	PII [REDACTED] 48TH AVE (SIDEWALK)	WPS	D/B/F	5/20/07	NA
2	(2) SWABS, CONTROL / @ CONE (A)	" / " "				
3	(2) SWABS, POSS. BLOOD / @ CONE (B)	PII [REDACTED] "				
4	(2) SWABS, CONTROL / @ CONE (B)	" / " "				
5	(2) SWABS, POSS. BLOOD / @ CONE (C)	" / " "				
6	(2) SWABS, CONTROL / @ CONE (C)	" / " "				
7	(2) SWABS, POSS. BLOOD / @ CONE (D)	PII [REDACTED] / 47TH AVE				
8	(2) SWABS, CONTROL / @ CONE (D)	" / " "				
9	(2) SWABS, POSS. BLOOD / @ CONE (E)	PII [REDACTED] 47TH AVE				
10	(2) SWABS, CONTROL / @ CONE (E)	" / " "				
11	(2) SWABS, POSS. BLOOD / @ CONE (F)	PII [REDACTED] 47TH AVE				
12	(2) SWABS, CONTROL / @ CONE (F)	" / " " ↓				

CHAIN OF CUSTODY

ITEM # (S)	DESCRIPTION	RELINQUISHED BY	RECEIVED BY	DATE	TIME

INCIDENT #

ID

EVIDENCE INVENTORY (FOR C.S.I. USE ONLY)
CRIME SCENE INVESTIGATIONS UNIT

STATUS CODES: B BOOKED F FREEZER D DRYING P TO BE PROCESSED + USABLE LATENTS -- NO USABLE PRINTS

#	ITEM	LOCATION FOUND	COLLECTED REC'D FROM	INITIAL STATUS	DATE BOOKED	LATENTS + - n/a
13	(2) SWABS, POSS. BLOOD @ CONE (G)	PII 47 TH AVE	605	D/B/F	5/26/07	NA
14	(2) SWABS, CONTROL @ CONE (G)	" " "				
15	(2) SWABS, POSS. BLOOD / FRM. OUTSIDE WALL	PII 47 TH AVE				
16	(2) SWABS, CONTROL / "	" " "				
17	(2) SWABS, WATER CONTROL / TARAVAL ST	TARAVAL ST.				
18	2 SWABS, WATER CONTROL / 47 TH AVE	47 TH AVE	↓	↓	↓	↓

CHAIN OF CUSTODY

ITEM # (S)	DESCRIPTION	RELINQUISHED BY	RECEIVED BY	DATE	TIME

CSI 14

CASE NO. ID	Crime Scene Investigations			DATE/TIME RCVD.			
	FIREARM PROCESSING REQUEST			DATE/TIME REQ'D.			
	OFFENSE <u>217</u>	ARREST MADE <input type="checkbox"/>	REQ BY <u>GRA & HOR</u>	STAR <u>1524</u>	UNIT <u>SH</u>	RUN DATE <u>5-19-07</u>	ARRIVAL TIME
	COMPLAINANT <u>SFPD</u>					CSO/STAR <u>S. Gregory 986</u>	
	LOCATION OF RUN <u>Great Hwy & SANTIAGO</u>					CSO/STAR	
REMARKS/ INSTRUCTIONS							

FIREARM INFORMATION REPORT

/ REVOLVER / SEMI-AUTO / SHOTGUN / RIFLE / OTHER _____

FIREARM: _____

Make: BERETTA
 Model: 92 FS
 Serial #: [REDACTED]
 Caliber: 9mm
 Barrel Length: 5"
 Finish: Blue
 Grips: PLASTIC

Ammunition: _____

Headstamps: / Varied (Listed Below)
 All Identical: 1 R.P. ROUND 1M
MAR GRAINE

DNA SWABS: _____

Preserved for DNA: YES NO UNK
 Grips Swabbed: YES NO NA
 Swabs Booked: _____ / _____
 (DATE) (BY)

Magazine in Weapon? YES NO NA Weapon Cocked? YES NO Safety On? YES NO NA

Unloaded Prior to CSI? YES NO Weapon Processed? YES NO NA Latents Recovered? YES NO

Notes: Chamber Loaded with Fired 9mm R/P Shell, Blood Found + Around Trigger Protector + collected

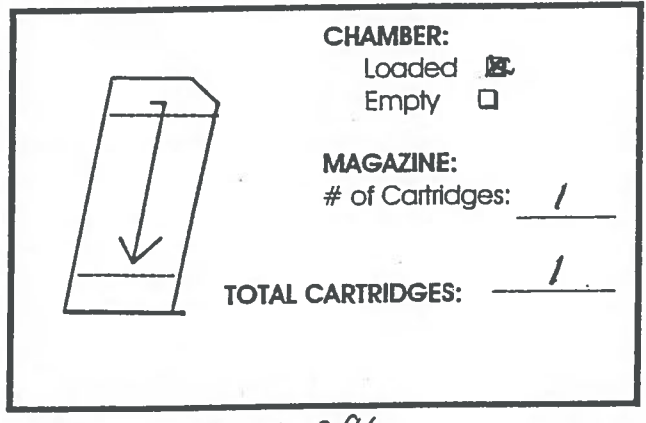
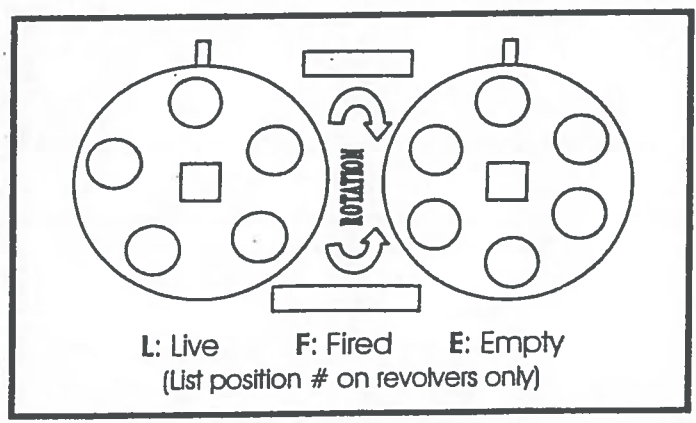

FIREARM & CONTENTS BOOKED ON 5-19-07 BY S.G. 986 SFPD 235A

CASE NO. ID

Crime Scene Investigations
FIREARM PROCESSING REQUEST

OFFENSE OFF INV 217	ARREST MADE X	REQ BY GAYNOR	STAR 1524	UNIT 5H
COMPLAINANT SFPD				
LOCATION OF RUN HOMICIDE UNIT, HOJ 5TH FLR.				
REMARKS/ INSTRUCTIONS SEIZED WEAPON & MAGAZINES FROM OPER. CARVALLO				

DATE/TIME RCVD.	
DATE/TIME REQ'D.	
RUN DATE 5/19/07	ARRIVAL TIME 0957
CSO/ STAR GANSTER 1830	
CSO/ STAR	

FIREARM INFORMATION REPORT

/ REVOLVER / SEMI-AUTO / SHOTGUN / RIFLE / OTHER _____

FIREARM:

Make: _____

Model: _____

Serial #: _____

Caliber: 40 CAL

Barrel Length: _____

Finish: BLK

Grips: BLK

Ammunition:

Headstamps: Varied (Listed Below)

All Identical: _____

DNA SWABS:

Preserved for DNA: YES NO UNK

Grips Swabbed: YES NO NA

Swabs Booked: _____ / _____
(DATE) (BY)

Magazine in Weapon? YES NO NA Weapon Cocked? YES NO Safety On? YES NO NA

Unloaded Prior to CSI? YES NO Weapon Processed? YES NO NA Latents Recovered? YES NO

Notes: MAGAZINE INSERTED IN GUN WELL MARKED - CONTAINED (12) LEI

40 LEI ROUNDS. MAGAZINE IN POUCH MARKED - CONTAINED (5) ROUNDS : 1X LEI

40 LEI & 4X LEI 40 LEI MAGAZINE IN POUCH (UNMARKED) CONTAINED (12)

LEI 40 LEI ROUNDS.

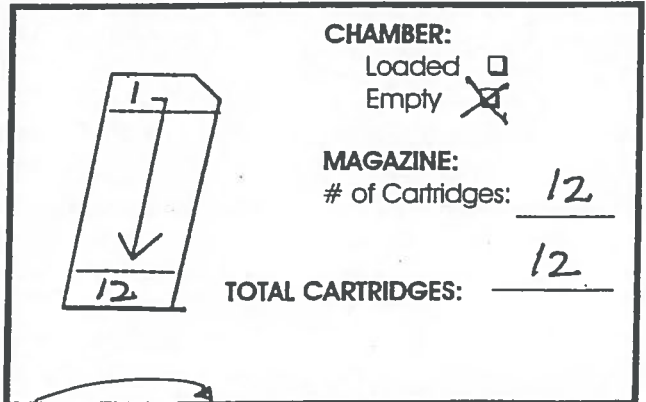
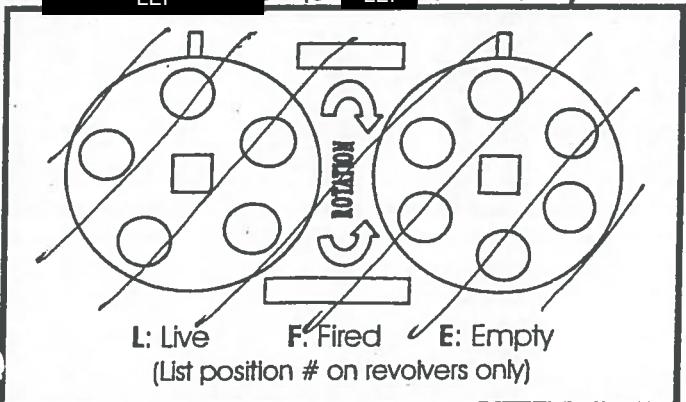

FIREARM & CONTENTS BOOKED ON PII 1830 BY 5/19/07 SFPD 235A

CASE #	CRIME SCENE INVESTIGATIONS			DATE/TIME RECEIVED		
	BIOLOGICAL EVIDENCE COLLECTION REPORT					DATE/TIME REQUESTED
	OFFENSE <i>27</i>	ARREST MADE <input type="checkbox"/>	REQ BY	STAR	UNIT	N/R CARD LEFT <input type="checkbox"/>
	COMPLAINANT <i>SFPD</i>			PHONE		RUNDATE <i>5-19-07</i>
	LOCATION OF RUN <i>GREAT HAY & SAMITAGE</i>					ARRIVAL TIME
	REMARKS/INSTRUCTIONS					CSO/STAR <i>S. Gregory 980</i> <i>OSKITA 4112</i>

NAME OF SUBJECT ID [REDACTED]	DOB/CDL/SFNO/CI PII [REDACTED]	ARREST <input type="checkbox"/> DETAINED <input type="checkbox"/> 802 <input type="checkbox"/> VICTIM <input type="checkbox"/>
IF DETAINED OR VOLUNTEERING ONLY, SIGNATURE OF CONSENT:		
SUBJECT:	WITNESSED BY:	

TYPE OF BIOLOGICAL EVIDENCE COLLECTION:

PENILE SWAB ONLY ADDITIONAL ORAL REFERENCE SWAB ORAL SWAB ONLY

FINGERNAIL SCRAPINGS
(LEFT / RIGHT HANDS)

HAIR SAMPLES FROM HEAD
(# OF HAIRS AND LOCATION)

SWAB FROM OTHER BODY AREA
(DESCRIBE LOCATION)

NOTES: *URINE FORM WAS USED TO COLLECT GSR*
SEE FIRE ARM FORM FOR INFORMATION ON
GUM. SUSPECT HANDS COVERED IN DIRT & SOME
Blood

BIOLOGICAL EVIDENCE INVENTORY (FOR C.S.I. USE ONLY)					
#	ITEM	COLLECTED FROM	COLLECTED BY	INITIAL STATUS	DATE BOOKED

CHECKLIST:

WAS COURT ORDER PREPARED? YES NO N/A

WAS DETAIL INSPECTOR PRESENT? YES NO

NAME: _____ STAR: _____ DETAIL: _____

SUBJECT FINGERPRINT

PII [REDACTED]

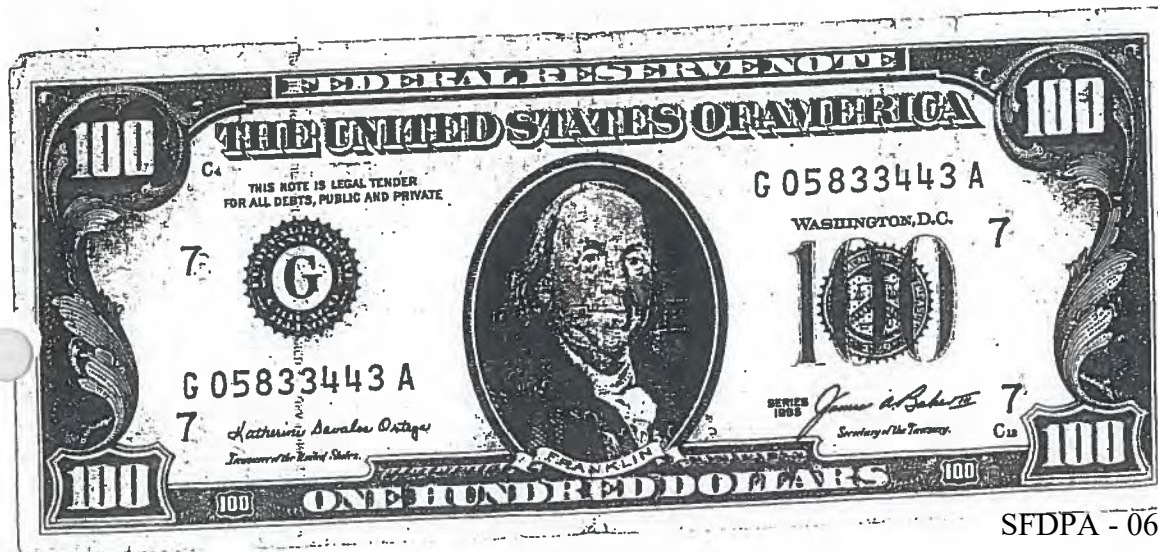

CSL 18



ID, PII, CSD

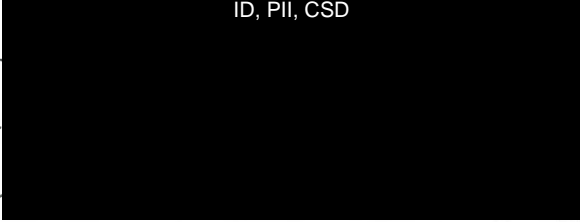

ID, PII, CSD



ID, PII, CSD



(b)(7)(C) & (b)(7)(D)

PII



PII

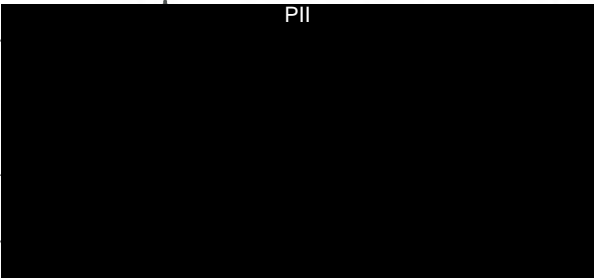

ID

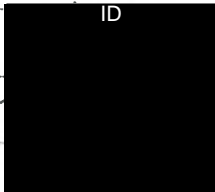



Crime Scene Investigations
INVESTIGATIVE NOTES

CASE# _____

DATE _____ TIME _____

1	THRUCL 75 ²	26 ¹¹	Street	
2	75 ⁹	29	"	40 shells
3	77 ¹⁰	30 ¹⁰	"	40
4	78 ⁸	28 ³	"	40 shells
5	80 ¹	27 ⁹	"	Brackets
6	88 ¹¹	9 ⁹	"	40 shells
7	67 ⁹	2 ⁷	"	40 shells
8	72 ¹⁰	6 ⁸	"	40 shells
9	90 ⁶		"	MAG PART
10	160 ²	10 ⁵	12' 11"	SPONGE
11	MISSILE ^T			
12	MISSILE [#]			
13	95 ¹	5 ⁹	Street	BULLET
14	97 ³	4	"	1405'
15	99 ⁷	2 ⁵	"	9 shells
16	100 ⁵	Curb	Street	9 shells
17	99 ⁷	"	"	9 shells
18	99 ³	5 ¹¹		7 shells

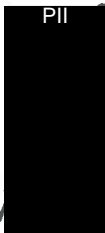

[Handwritten signature]



Crime Scene Investigations
INVESTIGATIVE NOTES

CASE# _____

DATE _____

TIME _____

SFDPA - 0662-08 - 000083

#130 er vehicle

#11-12 MISS NO ↑

ST. LIGHTS

Page ___ of ___

CSI 22

INITIALS/STAR

[Redacted]

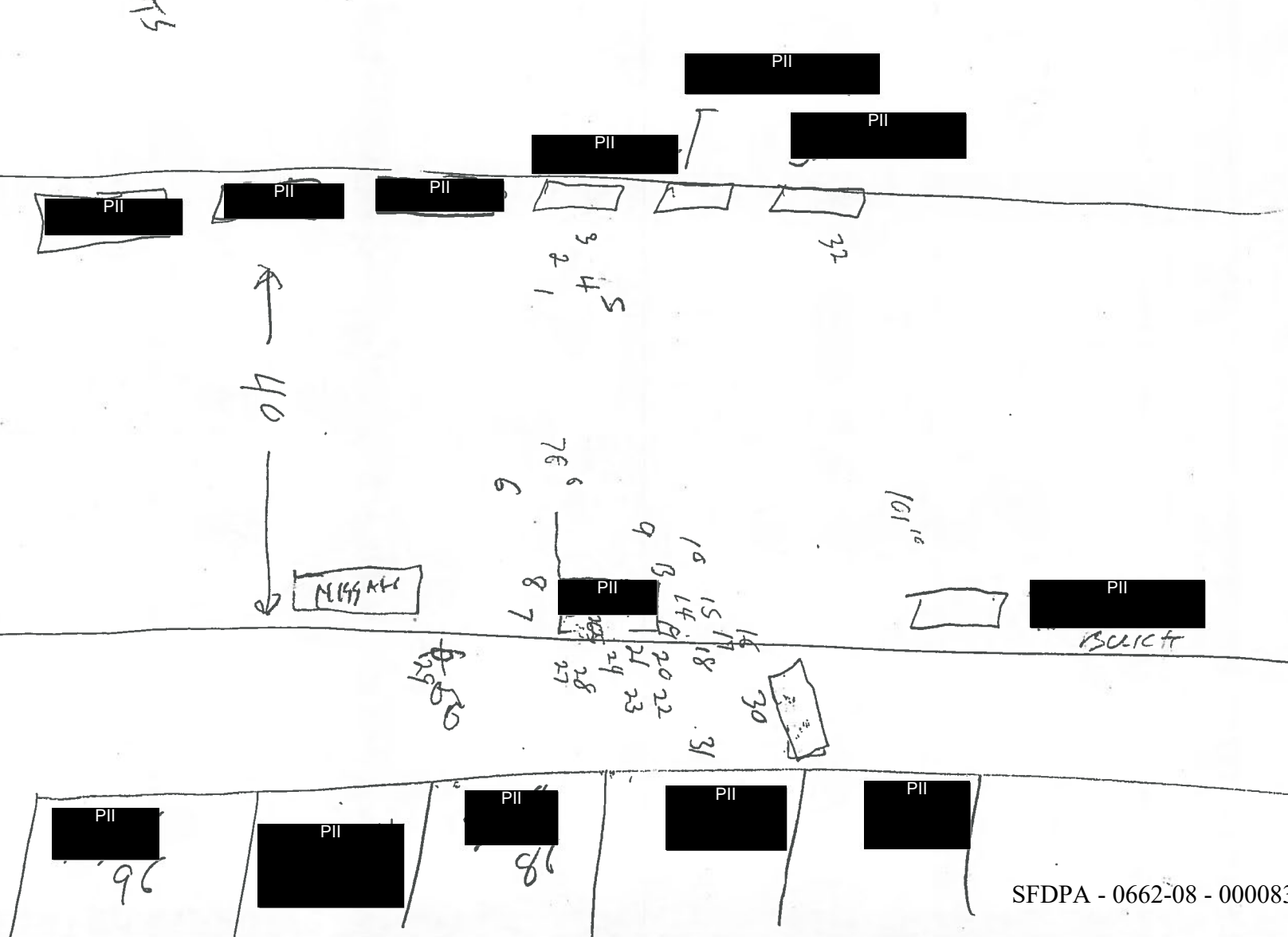



Crime Scene Investigations
INVESTIGATIVE NOTES

CASE# [REDACTED] ID [REDACTED]

DATE 5-19-07 TIME 03:24

[REDACTED] PII - 48 Ave

PUBLIC ST police vehicle into

BUILDING AT [REDACTED] PII - 48 TH Ave

Vehicle 531 Ford [REDACTED] PII

NISSAN [REDACTED] PII QUEST
BULLET DAMAGE R/F INTO VEH CONC. IN SIDE
RIGHT REAR GLASS Comp/MISSILE
REAR GLASS STAIN

COOL HIGH CLOUDS

[REDACTED] PII NISSAN P/U

FRONT WINDSHIELD

BITE ON SIDE WALK

BLOOD RIGHT SIDE OF VEHICLE + START OF
A TRAIL ON SIDEWALK

[REDACTED] PII GREAT HIGHWAY 459 BITE [REDACTED] PII



Crime Scene Investigations
INVESTIGATIVE NOTES

CASE# _____

DATE _____ TIME _____

19	94 ⁷	3"	ST	9 shell
20	93	7"	SIDEWALK	9 shell
21	91 ⁴	7"	STREET	JACKET
22	92	3 ⁹	SIDEWALK	9 shell
23	89 ³	3 ¹⁰	SIDEWALK	9 shell
24	87 ⁹	8	SIDEWALK	9 shell
25	87 ²	8	STREET	9 shell
26	87 ²	1"	STREET	9 shell
27	82 ⁹	1 ⁹	SIDEWALK	SHELL
28	85 ⁸	1'	SIDEWALK	BLOOD
29	61 ¹⁶	7 ²	"	BITE
30	105 ⁸	6 ⁵	"	15' shell
31	95 ¹	16'	"	FRAG
32	122		STREET	JACKET





Crime Scene Investigations
INVESTIGATIVE NOTES

CASE# _____

DATE _____ TIME _____

PII [REDACTED]

47 Ave Blood

PII [REDACTED]

SANTIAGO Blood Side of House

Suspect + GUN recovered

SANTIAGO GH / ASK DOOR

HOLE GARAGE DOOR BOTTOM

PII [REDACTED]

RETURN TO

PII [REDACTED]

Block 48TH Ave

LOADED

LEAD IN ST S/BUILDING

PII [REDACTED]

.48

+

DAMAGE TO SAME

BUILDING

NORTH SIDE

PII [REDACTED] 78



San Francisco Police Department
Forensic Services Division - Criminalistics Laboratory
Tel: 415.671.3200 / Fax: 415.671.3290
Report of Laboratory Examination

Case Number [REDACTED] ID
Laboratory Number CN 07-0425
Incident Date 05/19/07
Requested By Insp. Michael Gaynor
Detail / Agency Homicide
Victim / Complainant SFPD
Suspect [REDACTED] ID
Report Date October 17, 2007

DESCRIPTION OF EVIDENCE

On August 3rd, 2007, Item #4 and Item #14 were retrieved from the SFPD Property Control Division (PCD).

Items #4-1, 2, 3, 4: Oral reference swabs from [REDACTED] ID

Item #14

Items #14A-1, 2: Blood swabs from sidewalk #28
Items #14B-1, 2: Control swabs from sidewalk #28
Items #14C-1, 2: Blood swabs, right side of Nissan
Items #14D-1, 2: Water control swabs
Items #14E-1, 2: Control swabs, right side of Nissan

PURPOSE OF EXAMINATION

The purpose of this examination was to conduct genetic analysis on the blood swabs (Item #14) and compare results with the submitted reference sample from [REDACTED] ID (Item #4).

RESULTS OF EXAMINATION

Biological Evaluation

Blood swabs and control swabs from sidewalk

The blood swabs (Item #14A-1 and Item #14A-2) consisted of intact cotton tipped applicators with red stains; these stains tested positive in a presumptive chemical test for blood. The control swabs (Item #14B-1 and Item #14B-2) consisted of intact cotton tipped applicators with grayish-black stains; the control swab (Item #14B-1) tested negative in a presumptive chemical test for blood. A portion of each blood swab (Item #14A-1 and Item #14A-2) and control swab (Item #14B-1) was sampled for genetic analysis.

Item #14B-2 was not examined at this time.

Blood swabs and control swabs from right side of Nissan

The blood swabs (Item #14C-1 and Item #14C-2) consisted of intact cotton tipped applicators with red stains; these stains tested positive in a presumptive chemical test for blood. The control swabs (Item #14E-1 and Item #14E-2) consisted of intact cotton tipped applicators with brownish-black stains; the control swab (Item #14E-1) tested negative in a presumptive chemical test for blood. A portion of each blood swab (Item #14C-1 and #14C-2) and control swab (Item #14E-1) was sampled for genetic analysis.

Item #14E-2 was not examined at this time.

Water control swab

The water control swabs (Item #14D-1 and Item #14D-2) consisted of intact cotton tipped applicators with no visible stains. A portion of the water control swab (Item #14D-1) was sampled for genetic analysis.

Item #14D-2 was not examined at this time.

Item #4-2, Item #4-3 and Item #4-4 were not examined at this time.

Genetic Analysis

The **blood swabs** (Items #14A-1, #14A-2, #14C-1 and #14C-2), **control swabs** (Items #14B-1 and #14E-1) and **water control swab** (Item #14D-1) were subjected to a DNA extraction process. Subsequently, the reference sample (Item #4-1) was subjected to a DNA extraction process. All samples were amplified and typed using the AmpFISTR Profiler Plus DNA typing system. See Table of Results.

**Table of Results
 AmpFISTR Profiler Plus**

ITEM	D3S1358	VWA	FGA	AMEL	D8S1179	D21S11	D18S51	D5S818	D13S317	D7S820
Item 4-1: Oral reference ID [REDACTED]	16,16	17,17	23,25	X,Y	12,14	27,28	17,17	9,9	11,12	8,10
Item 14A-1: Blood swab from sidewalk	16,16	17,17	23,25	X,Y	12,14	27,28	17,17	9,9	11,12	8,10
Item 14A-2: Blood swab from sidewalk	16,16	17,17	23,25	X,Y	12,14	27,28	17,17	9,9	11,12	8,10
Item 14B-1: Control swab from sidewalk	ND	ND	ND	ND	ND	ND	ND	ND	ND	ND
Item 14C-1: Blood swab, right side of Nissan	16,16	17,17	23,25	X,Y	12,14	27,28	17,17	9,9	11,12	8,10
Item 14C-2: Blood swab, right side of Nissan	16,16	17,17	23,25	X,Y	12,14	27,28	17,17	9,9	11,12	8,10

Table of Results continued
AmpFISTR Profiler Plus

Item 14D-1: Water control swab	ND	ND	ND	ND	ND	ND	ND	ND	ND	ND
Item 14E-1: Control swab, right side of Nissan	ND	ND	ND	ND	ND	ND	ND	ND	ND	ND
Reagent Blanks	ND	ND	ND	ND	ND	ND	ND	ND	ND	ND

Key: X,Y = indicative of male gender ND = not detected

Blood swabs and control swab from sidewalk

Genetic analysis results indicate that no DNA was detected on the control swab taken from the sidewalk (Item #14B-1).

Genetic analysis results indicate that DNA from a single male donor was detected from the blood swabs taken from the sidewalk (Item #14A-1 and Item #14A-2). This DNA profile is the same as [REDACTED] ID DNA profile (Item #4-1). Therefore, [REDACTED] ID is included as a possible source of the blood on the sidewalk (Item #14A-1 and Item #14A-2).

Blood swabs and control swab from right side of Nissan

Genetic analysis results indicate that no DNA was detected from the control swab taken from the right side of the Nissan (Item #14E-1).

Genetic analysis results indicate that the same single male donor detected on the blood swabs from the sidewalk (Item #14A-1 and Item #14A-2) was also detected on the blood swabs taken from the right side of the Nissan (Item #14C-1 and Item #14C-2). This DNA profile is the same as [REDACTED] ID DNA profile (Item #4-1). Therefore, [REDACTED] ID is included as a possible donor of the blood on the right side of the Nissan (Item #14C-1 and Item #14C-2).

DNA STATISTICS

The probability that a random unrelated individual, by chance, would possess the same DNA profile as that detected from the blood on the sidewalk and the blood from the Nissan is approximately 1 in 106 trillion for US Caucasians, 1 in 6.9 trillion for African Americans, 1 in 361 trillion for California Hispanics, and 1 in 409 trillion for the general Asian population.

DISPOSITION OF EVIDENCE

Item #4 and Item #14 were returned to the SFPD PCD on October 16th, 2007. DNA extracts generated from the examination of Item #4 and Item #14 were packaged with their original evidence envelopes.

Examined By:

[REDACTED] PII

Cherisse Boland, Criminalist II



San Francisco Police Department
 Forensic Services Division – Criminalistics Laboratory
 Tel: 415.671.3200 / Fax: 415.671.3290
Report of Laboratory Examination
SUPPLEMENTAL

Case Number [REDACTED] ID
 Laboratory Number 07-0425
 Incident Date May 19, 2007
 Requested By Inspector Gaynor
 Detail / Agency Homicide / SFPD
 Complainant / Victim Cravalho and Morgado
 Suspect [REDACTED] ID
 Report Date February 21, 2008

The following evidence was received in the Criminalistics Laboratory on February 21, 2008.

DESCRIPTION OF EVIDENCE

Bag 20	Ex. 20-21	One fired copper jacket fragment (previously examined ~ See Report dated June 20, 2007)
Bag 31	Ex. 31-2	One fired copper fragment (previously examined ~ See Report dated June 20, 2007)
Bag 37	Ex. 37-1	One [REDACTED] LEI semiautomatic pistol, serial number [REDACTED] LEI

PURPOSE OF EXAMINATION

Standard firearms examination

RESULTS OF EXAMINATION

Bags 20, 31, and 37
 Ex. 20-21, 31-2, and 37-1
 The fragments Exhibits 20-21 and 31-2 both could neither be identified nor eliminated as having been fired from the Exhibit 37-1 [REDACTED] LEI pistol.

The pistol Exhibit 37-1 was examined and found to be functional. Tests were fired without a magazine.

The trigger pull was determined to be within manufacturer's specifications.

DISPOSITION OF EVIDENCE

The items, including test shots, will be returned to the property control division.

Examined By: [REDACTED] PII
 Mark Proia, Criminalist II
 Firearm and Tool Mark Unit



San Francisco Police Department
Forensic Services Division – Criminalistics Laboratory
Tel: 415.671.3200 / Fax: 415.671.3290
Report of Laboratory Examination

Case Number [REDACTED] ID
Laboratory Number 07-0425
Incident Date May 19, 2007
Requested By Inspector Gaynor
Detail / Agency Homicide / SFPD
Complainant / Victim Cravalho and Morgado
Suspect [REDACTED] ID
Report Date June 20, 2007

The following evidence was received in the Criminalistics Laboratory on June 13, 2007.

DESCRIPTION OF EVIDENCE

Bag 9 Ex. 9-1 One 9mm Parabellum (9mm Luger) caliber Beretta Model 92FS semiautomatic pistol, serial number [REDACTED] CI
One magazine

Ex. 9-2 One fired 9mm Luger caliber Remington-Peters cartridge case

Ex. 9-3 One 9mm Luger caliber Remington-Peters cartridge with an indented primer

Bag 15 Ex. 15-1 One apparent lead bullet core

Bag 16 Ex. 16-1 Two apparent lead fragments

Ex. 16-2 One magazine without a magazine spring and floorplate
One holster

Ex. 16-3 Fourteen 9mm Luger caliber cartridges (12 – Remington-Peters and 2 - Winchester)

Bag 19 Ex. 19-1 – 19-4,
19-6 – 19-8 Seven fired [REDACTED] LEI caliber [REDACTED] LEI cartridge cases

Bag 20 Ex. 20-13 One fired copper-jacketed bullet

Ex. 20-15 –
20-20, 20-22 –
20-27 Twelve fired 9mm Luger caliber cartridge cases (7 - Remington-Peters and 5 - Winchester)

Ex. 20-21 One fired copper jacket fragment

Ex. 20-30 One fired nickel-jacketed bullet

Ex. 20-31 One fired copper jacket

Ex. 20-32 One fired copper jacket

Bag 21 Ex. 21-1 One 40 [REDACTED] LEI caliber [REDACTED] LEI semiautomatic pistol,
serial number [REDACTED] LEI
Three magazines

Twenty-nine [REDACTED] LEI [REDACTED] caliber cartridges (28 – [REDACTED] LEI [REDACTED] and 1 - Federal)

Bag 31 Ex. 31-1 One fired copper-jacketed bullet
Ex. 31-2 One fired copper fragment
Ex. 31-3 One apparent lead fragment
Ex. 31-4 One nickel jacket fragment
Ex. 31-5 One fired copper-jacketed bullet
Ex. 31-6 One fired copper-jacketed bullet
Ex. 31-7 One fired nickel jacket
Ex. 31-8 One apparent lead bullet core
Ex. 31-9 One fired copper jacket

PURPOSE OF EXAMINATION

Standard firearms examination

RESULTS OF EXAMINATION

Bags 9, 20, and 31

Ex. 9-1 The pistol was examined and found to be functional using the submitted magazine. Tests were fired and compared to the NIBIN Database with negative results.

Ex. 9-2, 20-15 –
20-20, 20-22 –
20-27 The cartridge cases were all fired in the Beretta pistol Exhibit 9-1.

Ex. 9-3 The primer of the cartridge was indented by the firing pin of the Beretta pistol Exhibit 9-1.

Ex. 20-13,
20-31, 20-32,
and 31-1 The two bullets and two jackets were all fired from the [REDACTED] LEI [REDACTED] pistol Exhibit 21-1.

The exhibits were determined to be of 40 caliber displaying rifling characteristics of six lands and grooves, right twist.

Ex. 20-21 The copper jacket fragment could neither be identified nor eliminated as having been fired from the [REDACTED] LEI [REDACTED] pistol Exhibit 21-1.

The fragment was determined to display right twist.

Ex. 20-30,
31-4 – 31-7,
and 31-9

The three bullets, two jackets, and one jacket fragment were all fired from the Beretta pistol Exhibit 9-1.

The exhibits were determined to be of 9mm caliber displaying rifling characteristics of six lands and grooves, right twist.

Ex. 31-2

The copper jacket fragment could neither be identified nor eliminated as having been fired from the Beretta pistol Exhibit 9-1 or the [REDACTED] pistol Exhibit 21-1.

Ex. 31-3, 31-8

The apparent lead fragment and the apparent lead bullet core do not display class or individual characteristics and were not examined further.

Bags 15 and 16

Ex. 15-1, 16-1

The apparent lead bullet core and apparent lead fragments do not display class or individual characteristics and were not examined further.

Ex. 16-2, 16-3

The magazine without a magazine spring and floorplate, holster, and cartridges were not examined further.

Bag 19 Ex. 19-1 – 19-4,
19-6 – 19-8

The cartridge cases were all fired in the [REDACTED] pistol Exhibit 21-1.

Bag 21 Ex. 21-1

The pistol was examined and found to be functional using one of the submitted magazines.

The trigger pull was determined to be within manufacturer's specifications.

The remaining magazines and cartridges were not examined further.

DISPOSITION OF EVIDENCE

The items will be returned to the property control division.

Examined By:

[REDACTED] PII

Mark Proia, Criminalist II



San Francisco Police Department
Forensic Services Division – Criminalistics Laboratory
Tel: 415.671.3200 / Fax: 415.671.3290
Report of Laboratory Examination

Case Number [REDACTED] ID
Laboratory Number 07-0425
Incident Date 5/19/07
Requested By Insp. Gaynor
Detail / Agency Homicide
Complainant / Victim #1783, Cravalho; #466, Morgado
Suspect [REDACTED] ID
Report Date 7/11/07

The following evidence was received in the Criminalistics Laboratory on 6/26/07.

DESCRIPTION OF EVIDENCE

Bag 17 (2) GSR collection stubs: [REDACTED] ID

PURPOSE OF EXAMINATION

Examine the gunshot residue (GSR) collection stubs contained in Bag 17 for the presence of GSR.

RESULTS OF EXAMINATION

One characteristic GSR particle containing lead, barium and antimony was detected on the right hand sample from [REDACTED] ID. No characteristic GSR particles were detected on the left hand sample from [REDACTED] ID.

The presence of GSR on an individual's hands indicates that either:

- The individual fired a gun.
- The individual was in close proximity to a gun as it was discharged.
- The individual touched a gun or other object with GSR on its surface and particles were transferred to the hands.

DISPOSITION OF EVIDENCE

Bag 17 will be returned to the property control division.

Examined By: [REDACTED] PII

Linda Abuan, Criminalist II

Route

FROM: CABLE ISN: 00594 DATE: 08/20/08 TIME: 13:28:45 ADMIN MSG
TO: CTA0X002 OSN: 00022 DATE: 08/20/08 TIME: 13:28:46

INCACCNO= [REDACTED] ID BAGNO= 001 BAGTYPE= EN STOREDIN= D024 LOCATION= 276
HOLD= Y DESCRIPTION= STMT

INCACCNO= [REDACTED] ID BAGNO= 002 BAGTYPE= EN STOREDIN= D024 LOCATION= 194
HOLD= Y DESCRIPTION= STMT

INCACCNO= [REDACTED] ID BAGNO= 003 BAGTYPE= TE STOREDIN= 0554 LOCATION= 24
HOLD= Y DESCRIPTION= BLK SHORTS

INCACCNO= [REDACTED] ID BAGNO= 004 BAGTYPE= EN STOREDIN= FRZR LOCATION= A147
HOLD= Y DESCRIPTION= 2 PKS OF ORAL SWABS FROM [REDACTED] ID COPY SFPD FORM 235B

INCACCNO= [REDACTED] ID BAGNO= 005 BAGTYPE= EN STOREDIN= D024 LOCATION= 317
HOLD= Y DESCRIPTION= STATEMENT

INCACCNO= [REDACTED] ID BAGNO= 006 BAGTYPE= EN STOREDIN= D025 LOCATION= 65
HOLD= Y DESCRIPTION= SFPD 466, STATEMENTS, CRIME SCENE LOG

INCACCNO= [REDACTED] ID BAGNO= 007 BAGTYPE= EN STOREDIN= D025 LOCATION= 57
HOLD= Y DESCRIPTION= STATEMENT, DISK, S
(CONT.)

Route

FROM: CABLE ISN: 00595 DATE: 08/20/08 TIME: 13:28:45 ADMIN MSG
TO: CTA0X002 OSN: 00023 DATE: 08/20/08 TIME: 13:28:56

INCACCNO= [REDACTED] ID BAGNO= 008 BAGTYPE= EN STOREDIN= D025 LOCATION= 56
HOLD= Y DESCRIPTION= 3 DISK

INCACCNO= [REDACTED] ID BAGNO= 009 BAGTYPE= WP STOREDIN= D468 LOCATION= 13
HOLD= Y DESCRIPTION= BERRETTA 92FS 9MM 1 RND 1 SHELL 1 MAG

INCACCNO= [REDACTED] ID BAGNO= 010 BAGTYPE= TE STOREDIN= FRZR LOCATION= A147
HOLD= Y DESCRIPTION= SWABS

INCACCNO= [REDACTED] ID BAGNO= 011 BAGTYPE= TE STOREDIN= FRZR LOCATION= A147
HOLD= Y DESCRIPTION= SWABS

INCACCNO= [REDACTED] ID BAGNO= 012 BAGTYPE= TE STOREDIN= FRZR LOCATION= A147
HOLD= Y DESCRIPTION= SWABS

INCACCNO= [REDACTED] ID BAGNO= 013 BAGTYPE= TE STOREDIN= FRZR LOCATION= A147
HOLD= Y DESCRIPTION= KEYS, BATTERY, CHARGER, CLIP, PEN, LIGHTER, CELL

INCACCNO= [REDACTED] ID BAGNO= 014 BAGTYPE= EN STOREDIN= FRZR LOCATION= A147
HOLD= Y DESCRIPTION= SWABS
(CONT.)

Route

FROM: CABLE ISN: 00596 DATE: 08/20/08 TIME: 13:28:45 ADMIN MSG
TO: CTA0X002 OSN: 00024 DATE: 08/20/08 TIME: 13:29:05

INCACCNO= [REDACTED] ID [REDACTED] BAGNO= 015 BAGTYPE= TE STOREDIN= 0556 LOCATION= 67
HOLD= Y DESCRIPTION= BULLET FRAGMENT

INCACCNO= [REDACTED] ID [REDACTED] BAGNO= 016 BAGTYPE= TE STOREDIN= 0556 LOCATION= 68
HOLD= Y DESCRIPTION= HOLSTER, MAGAZINE, AMMO

INCACCNO= [REDACTED] ID [REDACTED] BAGNO= 017 BAGTYPE= TE STOREDIN= 0556 LOCATION= 69
HOLD= Y DESCRIPTION= GSR TEST

INCACCNO= [REDACTED] ID [REDACTED] BAGNO= 018 BAGTYPE= BG STOREDIN= FRZR LOCATION= D656
HOLD= Y DESCRIPTION= BLK BBALL CAP W/ POSS BLOOD

INCACCNO= [REDACTED] ID [REDACTED] BAGNO= 019 BAGTYPE= TE STOREDIN= 0556 LOCATION= 70
HOLD= Y DESCRIPTION= 40 CAL SHELLS

INCACCNO= [REDACTED] ID [REDACTED] BAGNO= 020 BAGTYPE= TE STOREDIN= 0556 LOCATION= 71
HOLD= Y DESCRIPTION= 12 9MM SHELLS, BULLET JKTS

INCACCNO= [REDACTED] ID [REDACTED] BAGNO= 021 BAGTYPE= WP STOREDIN= D469 LOCATION= 2
HOLD= Y DESCRIPTION= [REDACTED] LEI [REDACTED] 40CAL PISTOL SER [REDACTED] LEI [REDACTED] AMMO, 3MAGS
(CONT.)

Route

FROM: CABLE ISN: 00597 DATE: 08/20/08 TIME: 13:28:45 ADMIN MSG
TO: CTA0X002 OSN: 00025 DATE: 08/20/08 TIME: 13:29:12

INCACCNO= [REDACTED] ID BAGNO= 022 BAGTYPE= TE STOREDIN= 0556 LOCATION= 72
HOLD= Y DESCRIPTION= SYRINGE,BASE PLATE OF MAG

INCACCNO= [REDACTED] ID BAGNO= 023 BAGTYPE= TE STOREDIN= 0556 LOCATION= 73
HOLD= Y DESCRIPTION= BRACELET

INCACCNO= [REDACTED] ID BAGNO= 024 BAGTYPE= BG STOREDIN= 0557 LOCATION= 62
HOLD= Y DESCRIPTION= JACKET

INCACCNO= [REDACTED] ID BAGNO= 025 BAGTYPE= TE STOREDIN= 0556 LOCATION= 74
HOLD= Y DESCRIPTION= PR GLASSES,BLK COMB

INCACCNO= [REDACTED] ID BAGNO= 026 BAGTYPE= BG STOREDIN= FRZR LOCATION= D656
HOLD= Y DESCRIPTION= BLOODY SHOES,PAPER BAG

INCACCNO= [REDACTED] ID BAGNO= 027 BAGTYPE= BG STOREDIN= FRZR LOCATION= D656
HOLD= Y DESCRIPTION= BLOODY JOGGING PANTS,BLOODY JOGGING JACKET,BANDAN,BLOODY
T SHIRT,PAPER BAG

(CONT.)

Route

FROM: CABLE ISN: 00598 DATE: 08/20/08 TIME: 13:28:45 ADMIN MSG
TO: CTAOX002 OSN: 00026 DATE: 08/20/08 TIME: 13:29:19

INCACCNO= [REDACTED] ID BAGNO= 028 BAGTYPE= EN STOREDIN= D025 LOCATION= 114
HOLD= Y DESCRIPTION= NOTE

INCACCNO= [REDACTED] ID BAGNO= 029 BAGTYPE= EN STOREDIN= D025 LOCATION= 115
HOLD= Y DESCRIPTION= FAKE MONEY

INCACCNO= [REDACTED] ID BAGNO= 030 BAGTYPE= BK STOREDIN= LOCATION= 64
HOLD= DESCRIPTION= KORE GRN MTN BIKE

*** PROPERTY HAS BEEN DISPOSED OF **

INCACCNO= [REDACTED] ID BAGNO= 031 BAGTYPE= TE STOREDIN= 0562 LOCATION= 67
HOLD= Y DESCRIPTION= 4 BULLET FRAGMENTS

INCACCNO= [REDACTED] ID BAGNO= 032 BAGTYPE= EN STOREDIN= FRZR LOCATION= A147
HOLD= Y DESCRIPTION= SWAB

INCACCNO= [REDACTED] ID BAGNO= 033 BAGTYPE= TG STOREDIN= B606 LOCATION=
HOLD= Y DESCRIPTION= FRONT PASS DOOR FROM PATROL VEH531
(CONT.)

Route

FROM: CABLE ISN: 00599 DATE: 08/20/08 TIME: 13:28:45 ADMIN MSG
TO: CTAOX002 OSN: 00027 DATE: 08/20/08 TIME: 13:29:25

INCACCNO= [REDACTED] ID BAGNO= 034 BAGTYPE= EN STOREDIN= D025 LOCATION= 319
HOLD= Y DESCRIPTION= STATEMENT

INCACCNO= [REDACTED] ID BAGNO= 035 BAGTYPE= EN STOREDIN= D029 LOCATION= 86
HOLD= DESCRIPTION= CDL #N [REDACTED] ID, PII /F

INCACCNO= [REDACTED] ID BAGNO= 036 BAGTYPE= EN STOREDIN= D094 LOCATION= 259
HOLD= DESCRIPTION= LETTER + ENVELOPE

INCACCNO= [REDACTED] ID BAGNO= 037 BAGTYPE= WP STOREDIN= D516 LOCATION= 2
HOLD= DESCRIPTION= PISTOL, LEI

INCACCNO= [REDACTED] ID BAGNO= 038 BAGTYPE= EN STOREDIN= D094 LOCATION= 372
HOLD= DESCRIPTION= DOCUMENTS

** END OF OUTPUT **



PII

PII



SFDPA - 0662-08 - 000102



ALL INFORMATION CONTAINED HEREIN IS UNCLASSIFIED

DATE 08-21-2013 BY 60322

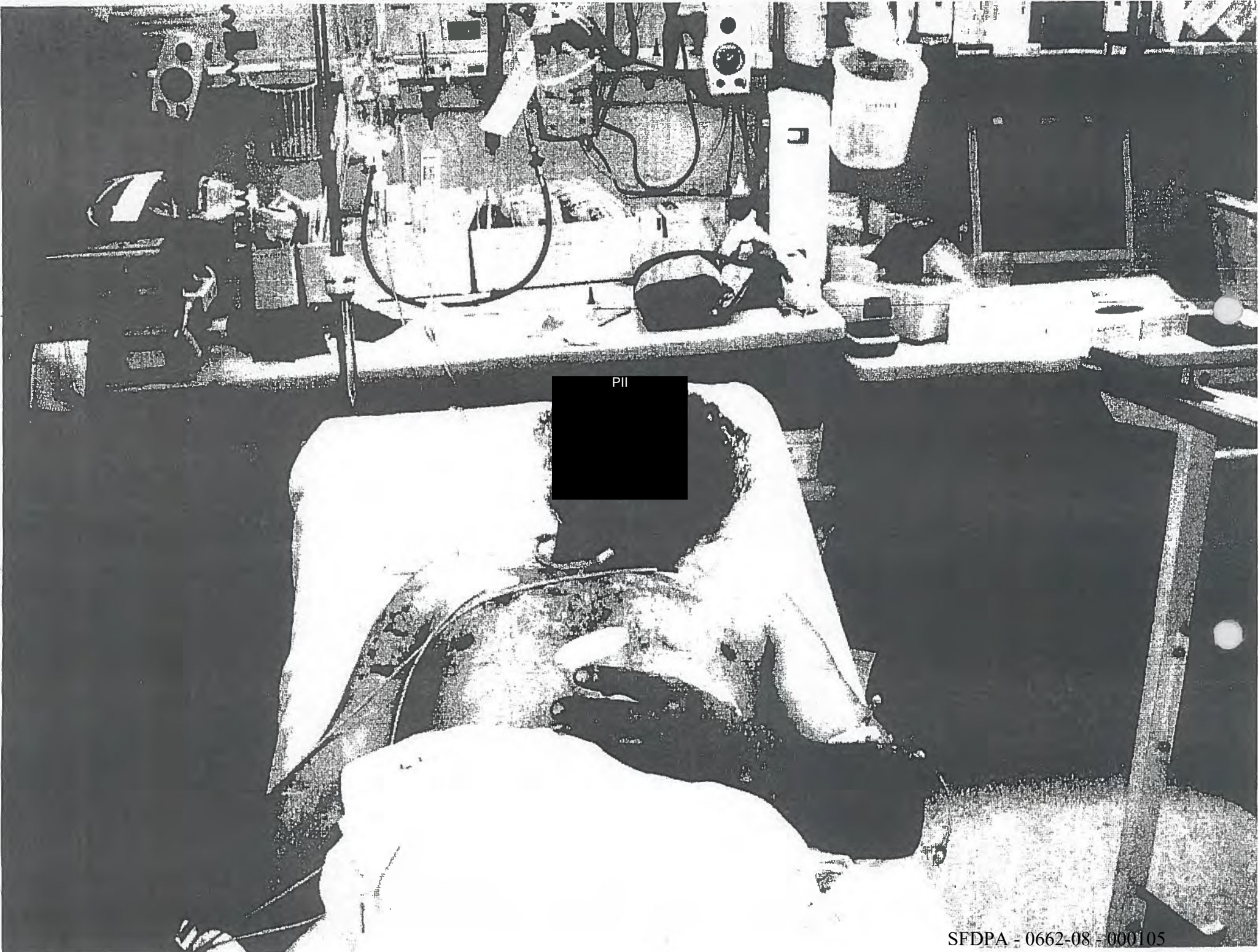

PI



PII



PII
PII



PII

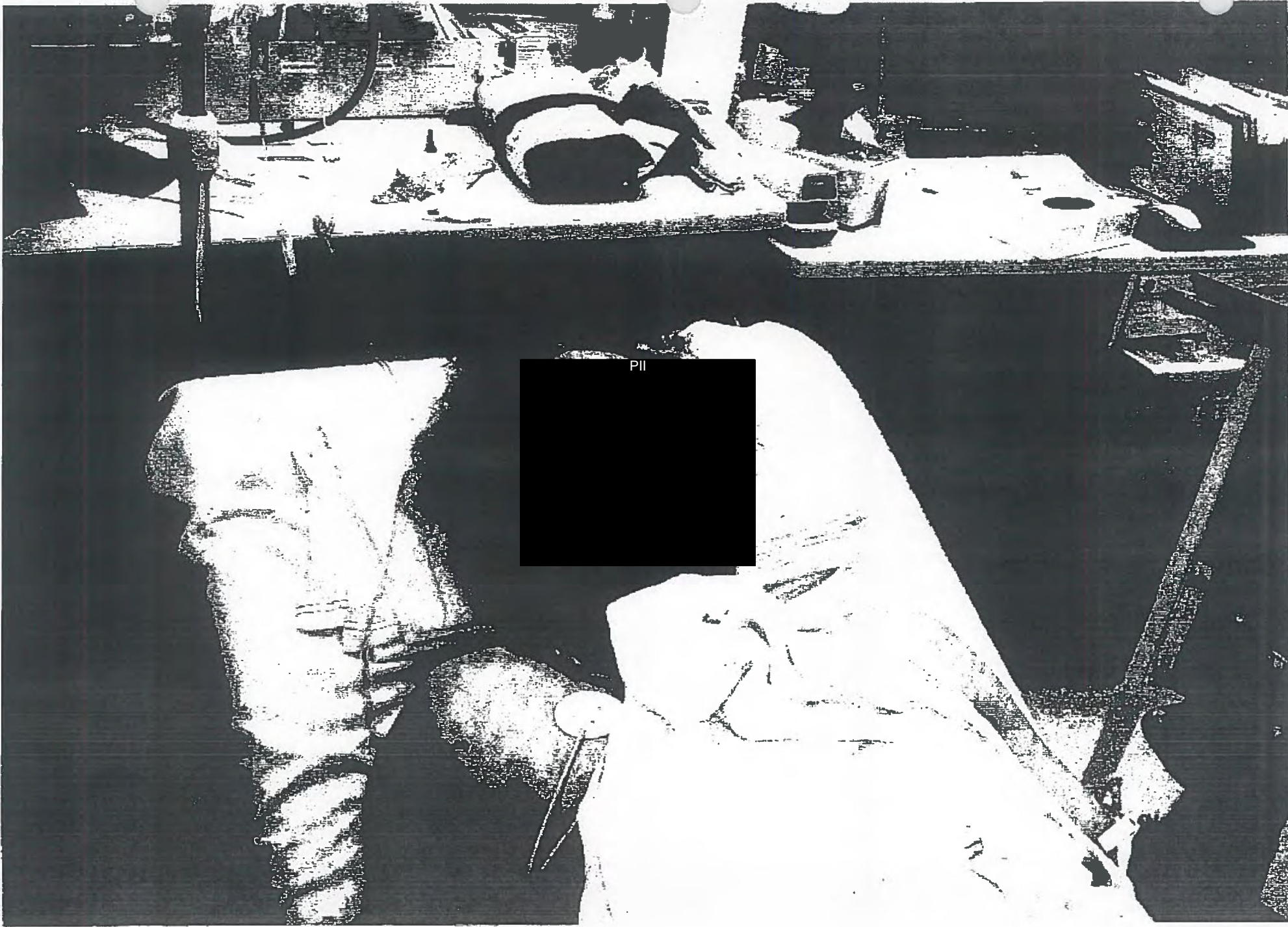

PII



PII



PII





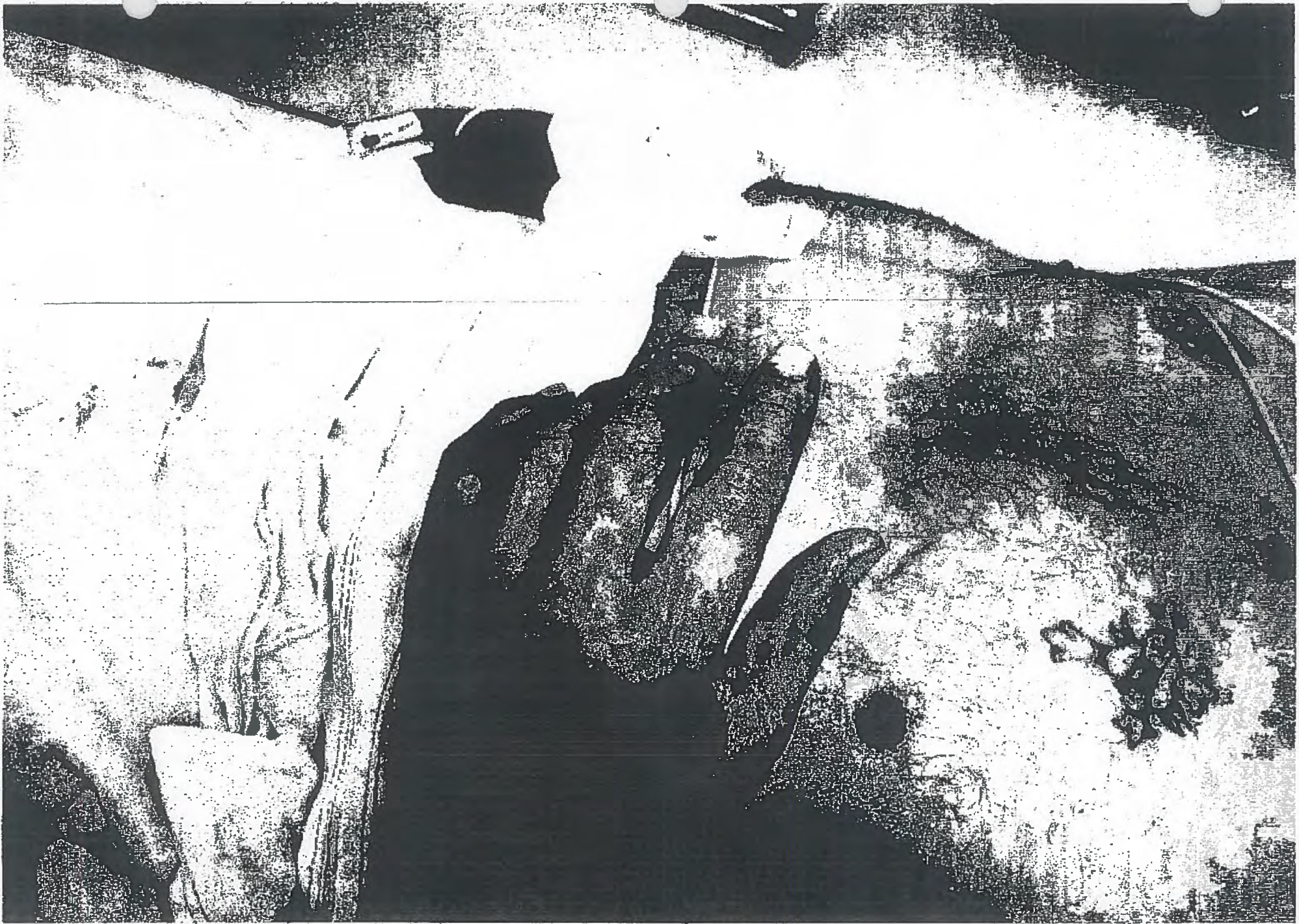

09/11/08

18:45

SFPD RMS → 92417733

NO. 483

D26

SFDPA - 0662-08 - 000114



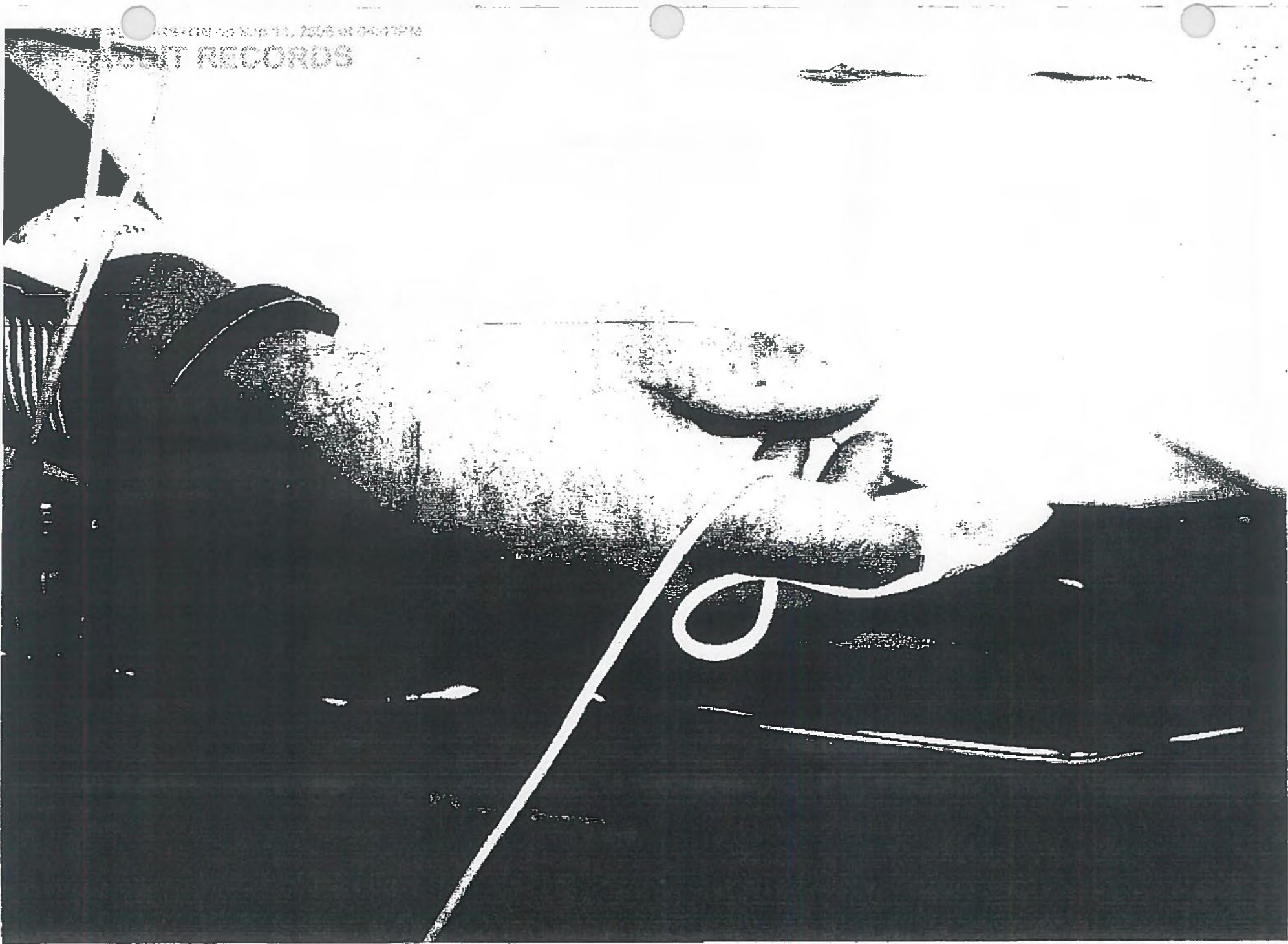

RECORDED ON SEP 11, 2008 AT 04:47 PM

INVEST RECORDS

09/11/08

18:45

SFPD RMS → 92417733

NO.483

028

SFDPA - 0662-08 - 000116

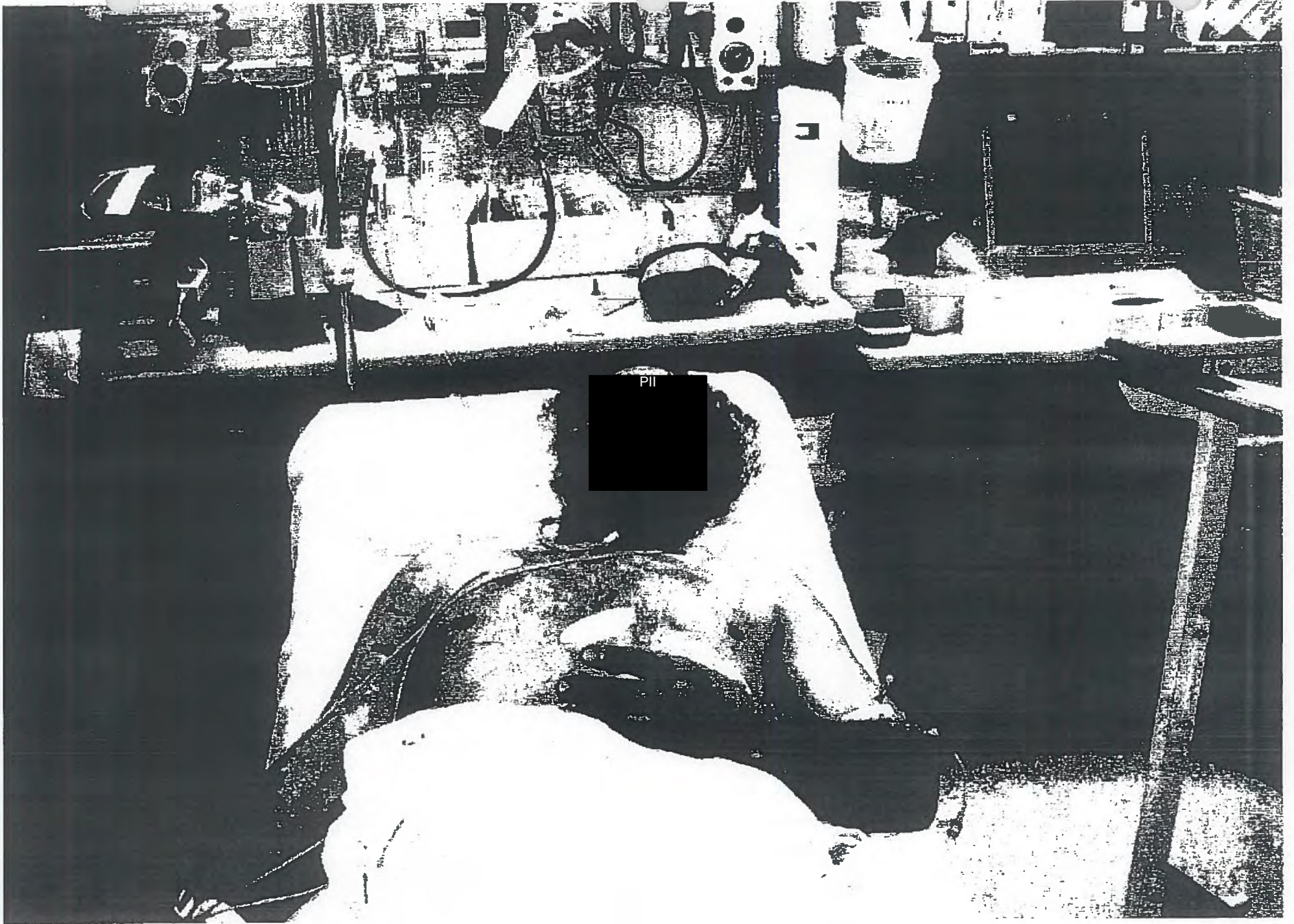



PII

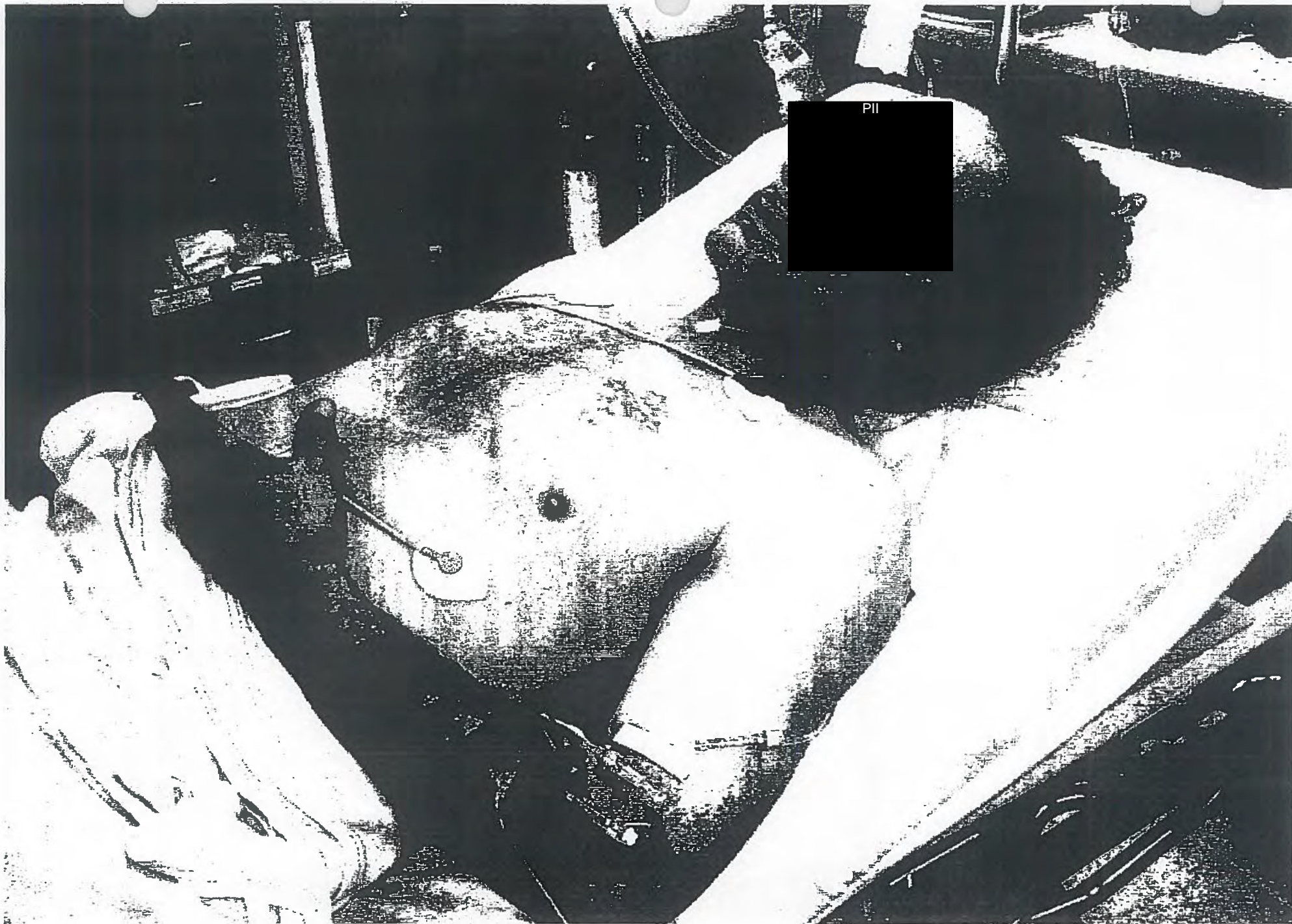

09/11/08

18:45

SFPD RMS → 92417733

NO.483

D31

SFDPA - 0662-08 - 000119

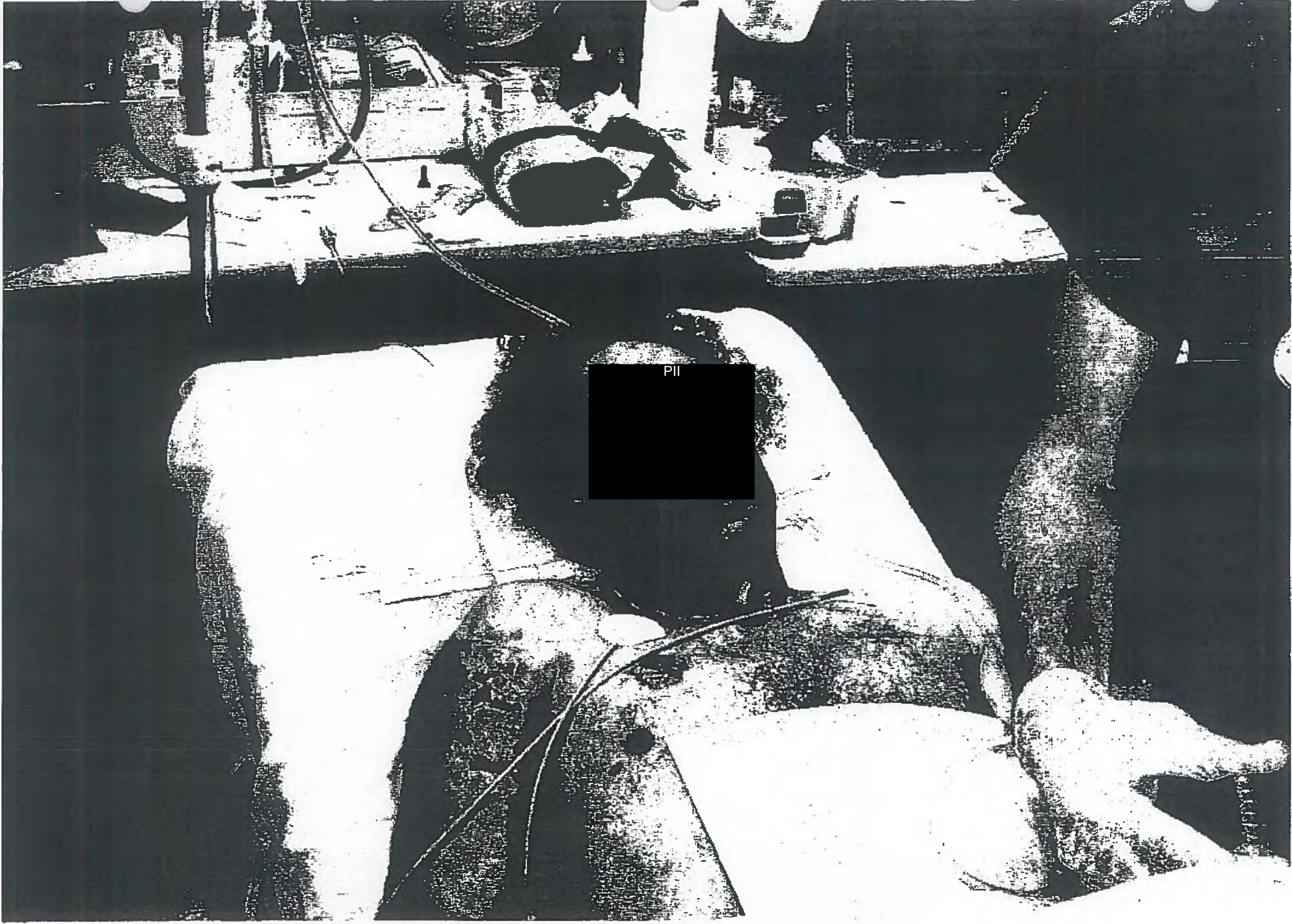

PII

09/11/08

18:45

SFPD RMS → 92417733

NO.483

D32

SFDPA - 0662-08 - 000120



09/11/08

18:45

SFPD RMS → 92417733

NO. 483

P33

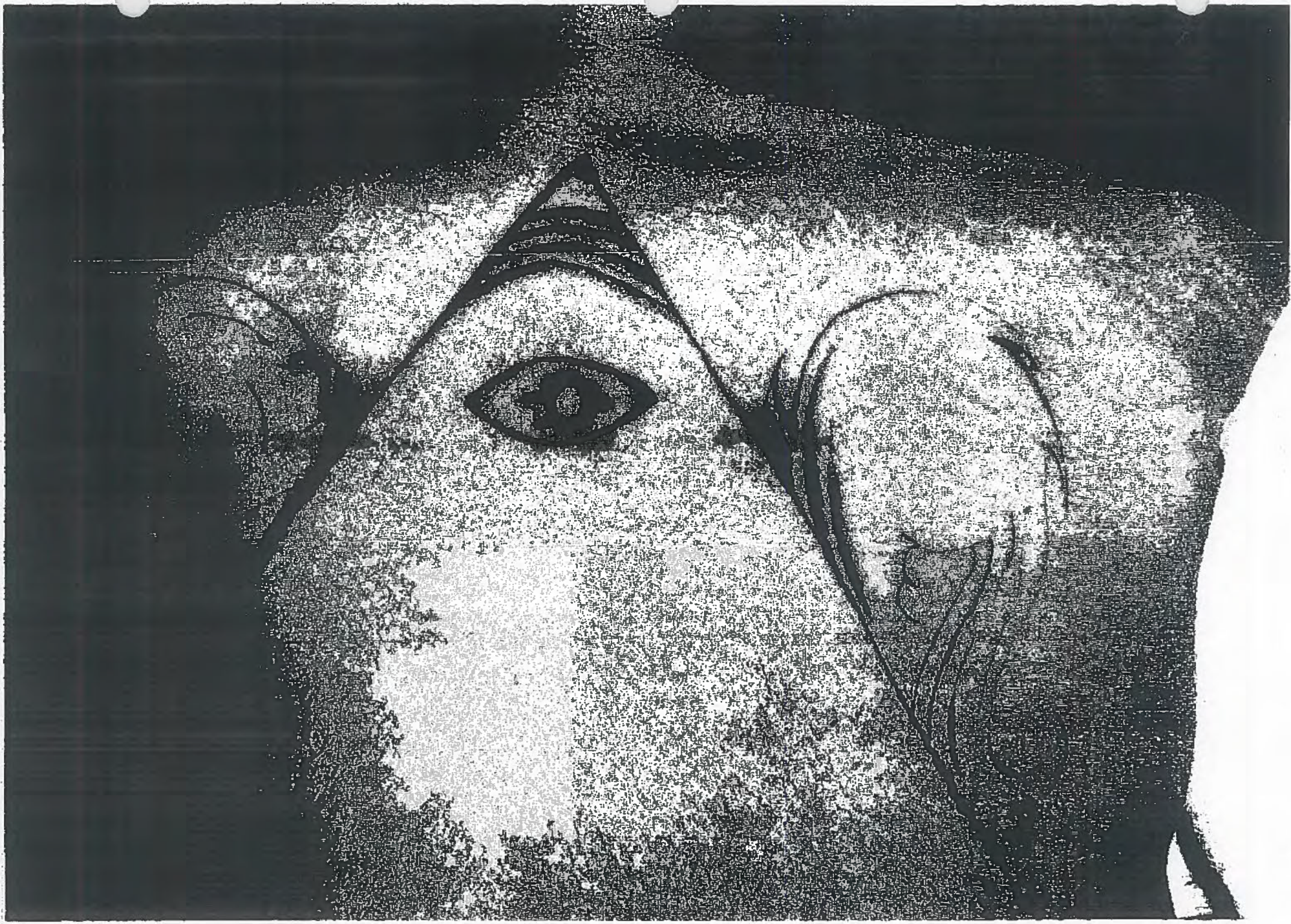

09/11/08

18:45

SFPD RMS → 92417733

NO. 483

D34

SFDPA - 0662-08 - 000122

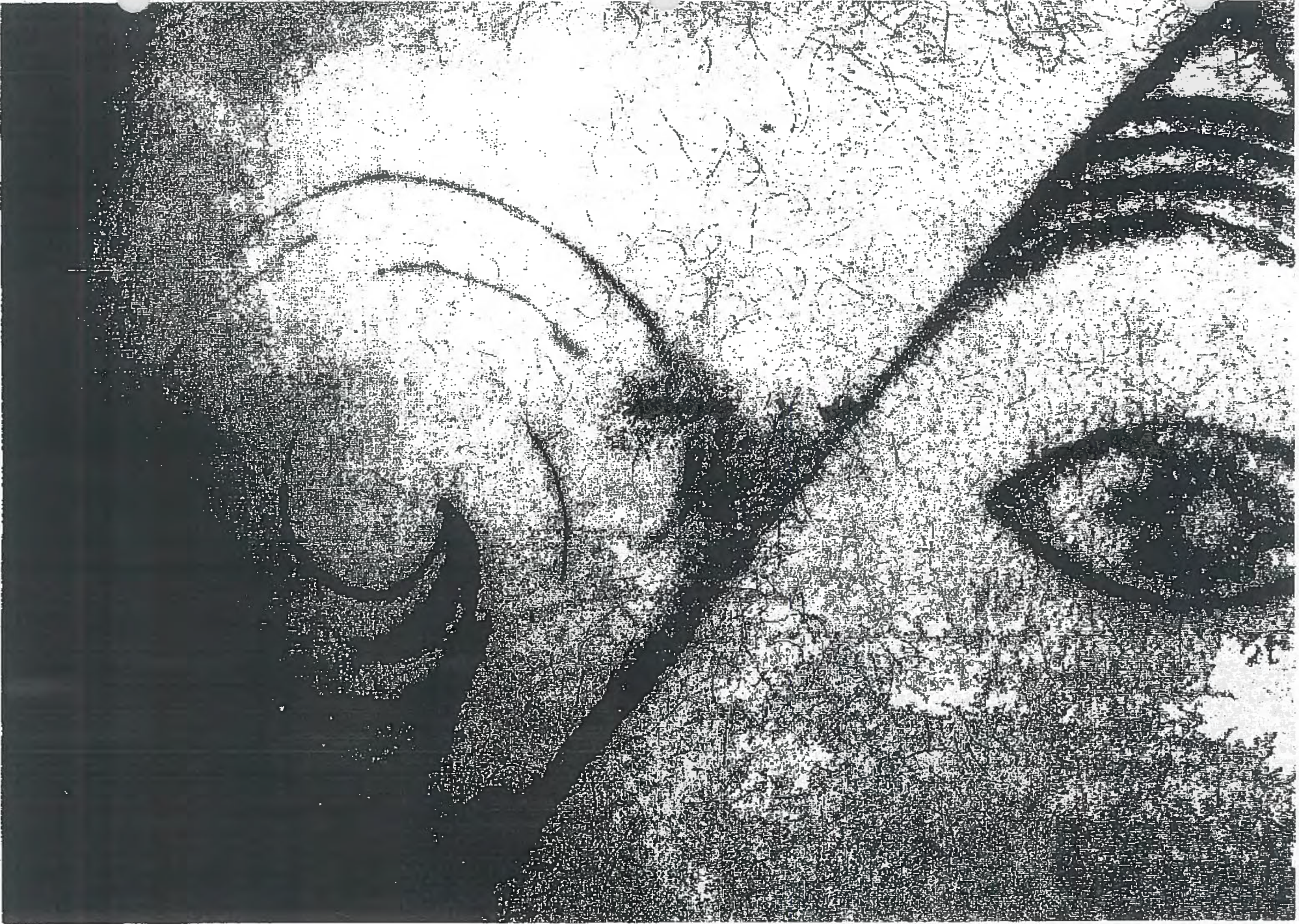

09/11 08

18:45

SFPD RMS → 92417733

NO. 483

P35

SFDPA - 0662-08 - 000123

POBRA





POBRA

POBRA





DATE _____ TIME _____
MED # _____
SUBJECT / NAME _____
LOCATION / ADDRESS _____
ADDITIONAL INFO _____
CHOKED BY _____ STATE _____
PHOTOGRAPHER _____ STATE _____
FILM SIZE & TYPE _____
THIS ENVELOPE IS FOR SAN FRANCISCO POLICE DEPARTMENT FILM DEVELOPER
INCHES



SFDPA - 0662-08 - 000129









SFDPA - 0662-08 - 000133



D



18-23-08

SFDPA - 0662-08 - 000135

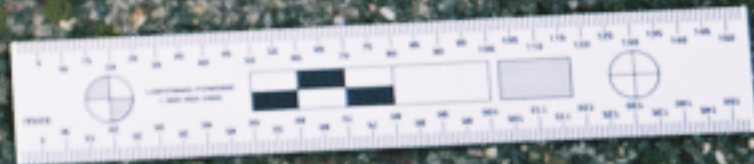

18 23:08

SFDPA - 0662-08 - 000136



PII



OP

3700 →
TARAVAL
← 2400
47TH AVE

PII

18 23:07

SFDPA - 0662-08 - 000139

08:22:01





18 22:39

SFDPA - 0662-08 - 000141



18 22:39

SFDPA - 0662-08 - 000142



18:22:34



18 22:34

SFDPA - 0662-08 - 000144



B



18 22:34

PII

PII

B

C

18 22:27

SFDPA - 0662-08 - 000147

A



18 22:26

SFDPA - 0662-08 - 000148



18 22:26

SFDPA - 0662-08 - 000149



18 22:26

SFDPA - 0662-08 - 000150



PII

PII



PII



5:22:28

PII

PII

PII

PII



5/22/25 13:28:25

PII

PII

5:22:28



PII

PII

ID

6:22:28 PM

211
GREAT HIGHWAY

NO
PARKING

ID



18 22:24

-2400
48TH AVE



10:22:01

48TH AVE







SFDPA - 0662-08 - 000160





SFDPA - 0662-08 - 000162



SFDPA - 0662-08 - 000163





SFDPA - 0662-08 - 000165

A close-up photograph of the front bumper of a dark-colored vehicle. The bumper is made of a dark plastic or metal material. In the center, there is a recessed area where a license plate would be. This area is completely obscured by a solid black rectangular redaction box. The text "PII" is printed in white on the top edge of this redaction box. To the right of the redaction, a metal tow hook is visible, attached to the bumper. The vehicle is parked on a light-colored, textured asphalt surface. The lighting is bright, creating some reflections on the upper part of the bumper.

PII



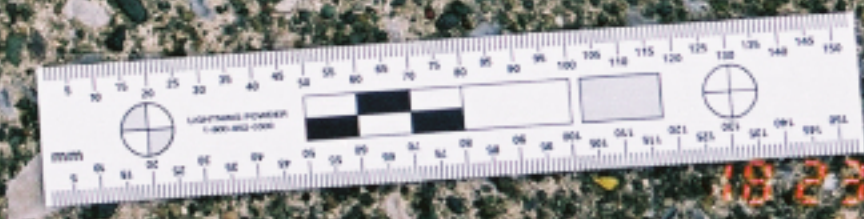

18-23-22
SFDPA - 0662-08 - 000168



PI

PII

09
07
00

G

F

Small white card on the ground

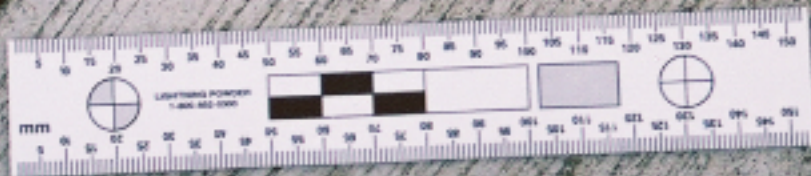

18 23: 18

SFDPA - 0662-08 - 000170

E

SVU

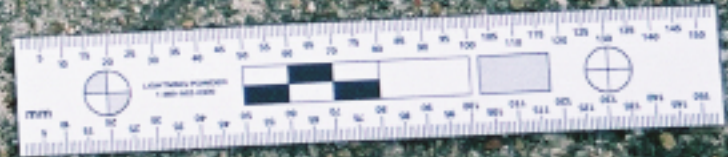

18 23 14



SFDPA - 0662-08 - 000172



SFDPA - 0662-08 - 000173



SFDPA - 0662-08 - 000174



PII

SFDPA - 0662-08 - 000175



SFDPA - 0662-08 - 000176





SFDPA - 0662-08 - 000178



SFDPA - 0662-08 - 000179



PII

PII



SFDPA - 0662-08 - 000181



SFDPA - 0662-08 - 000182



PII





SFDPA - 0662-08 - 000185



PII

SFDPA - 0662-08 - 000186



PII

PII



SFDPA - 0662-08 - 000188



SFDPA - 0662-08 - 000189



SFDPA - 0662-08 - 000190



SFDPA - 0662-08 - 000191



SFDPA - 0662-08 - 000192



PII

PII



QUEST
SE

PII

PII



PII

PII

PII





ID

SFDPA - 0662-08 - 000197



SFDPA - 0662-08 - 000198





SFDPA - 0662-08 - 000201





SFDPA - 0662-08 - 000203



PII





SFDPA - 0662-08 - 000206



SFDPA - 0662-08 - 000207

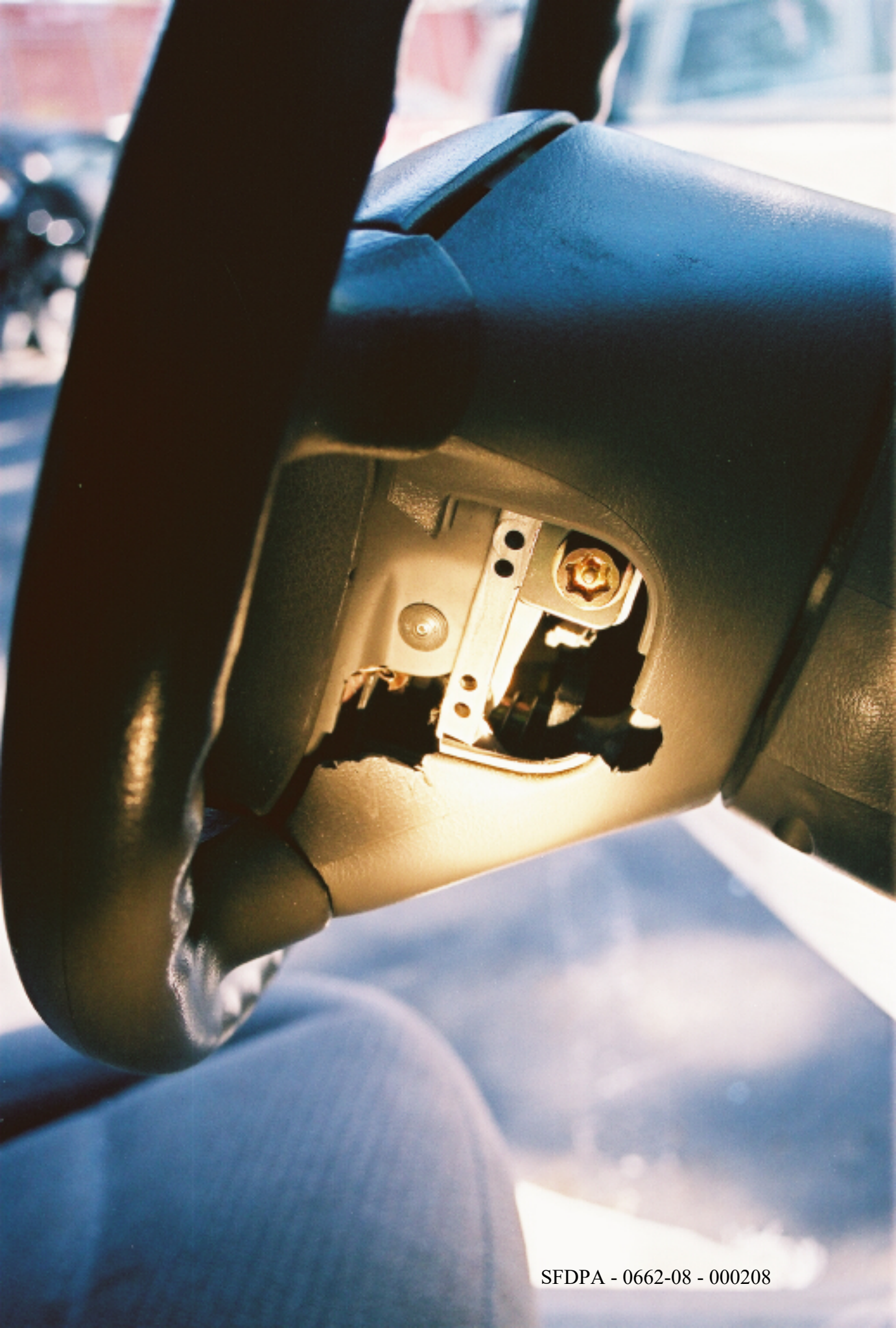

SFDPA - 0662-08 - 000208

PII





SFDPA - 0662-08 - 000210

CI

CI



SFDPA - 0662-08 - 000212



CI



SFDPA - 0662-08 - 000214



SFDPA - 0662-08 - 000215



SFDPA - 0662-08 - 000216

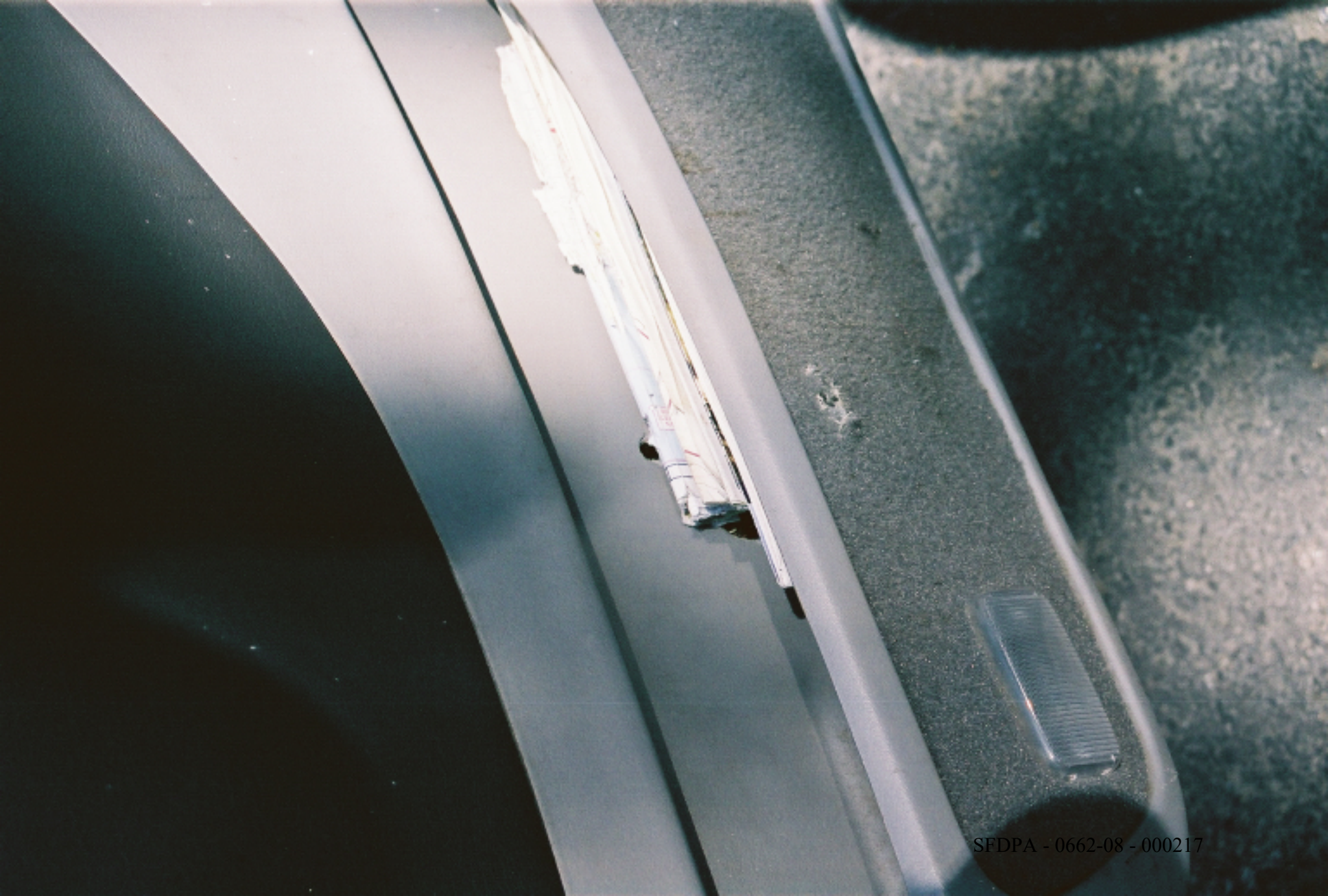

SFDPA - 0662-08 - 000217



SFDPA - 0662-08 - 000218



SFDPA - 0662-08 - 000219



SFDPA - 0662-08 - 000220

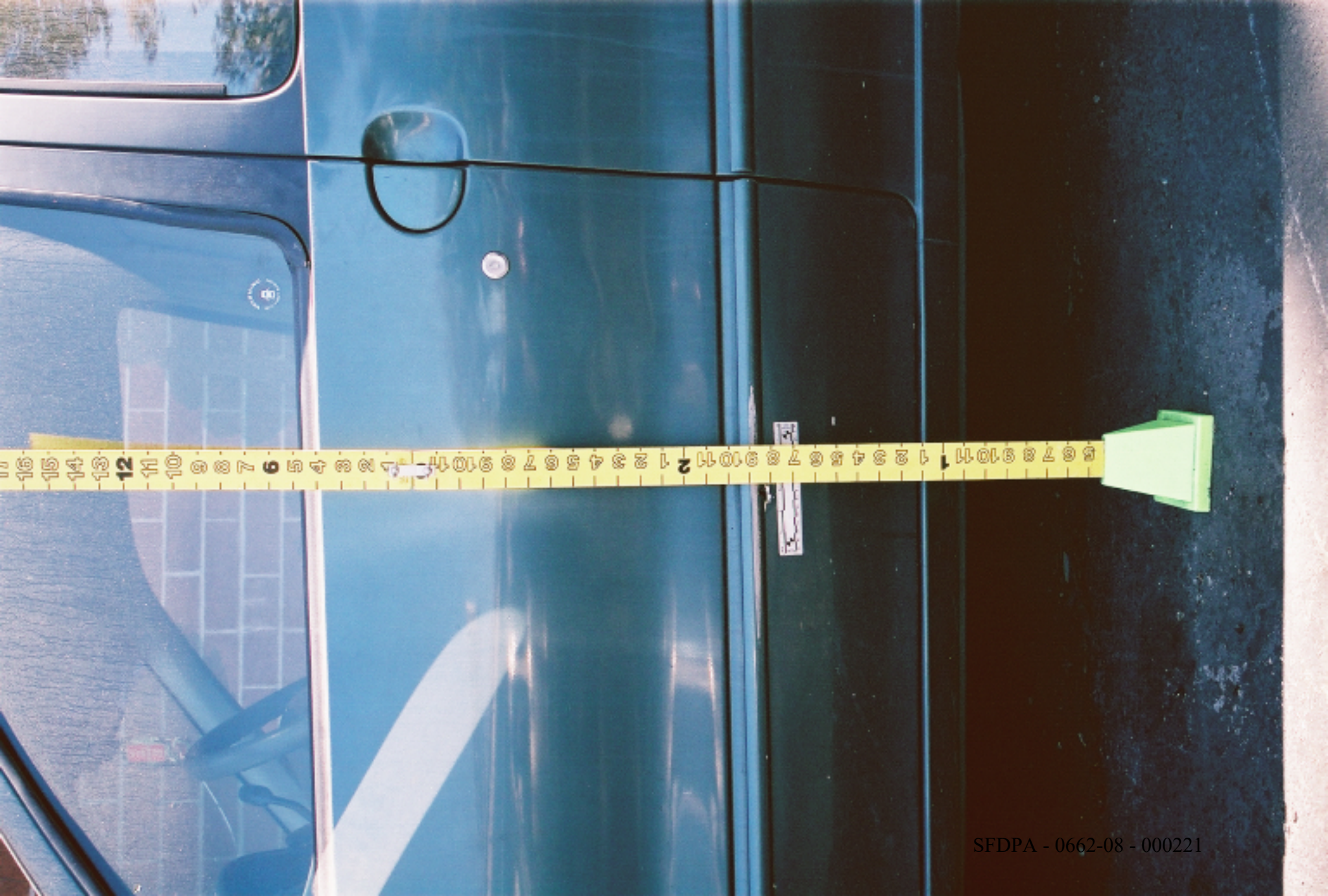

SFDPA - 0662-08 - 000221



SFDPA - 0662-08 - 000222

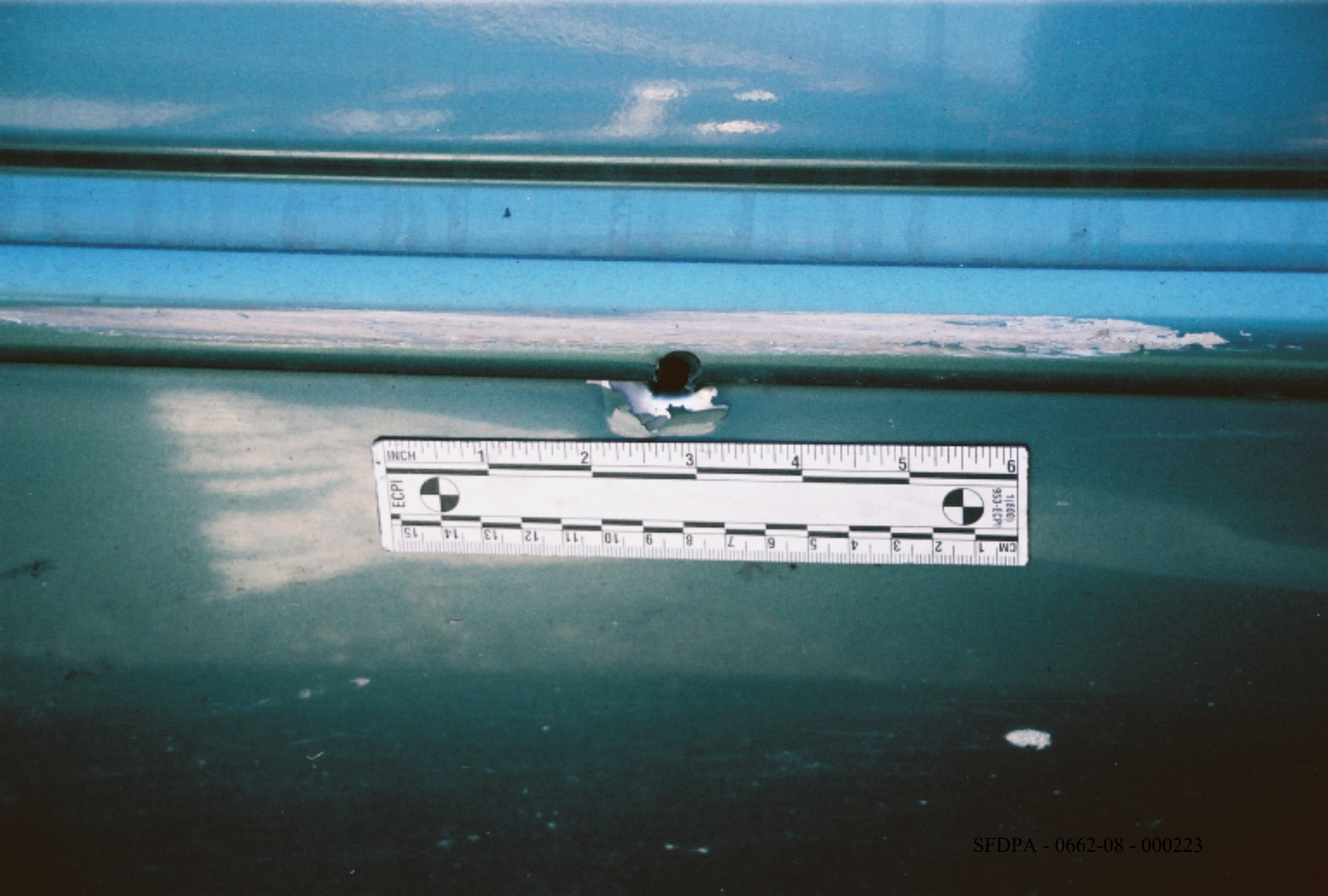



QUEST

SFDPA - 0662-08 - 000224





SFDPA - 0662-08 - 000226



PII

ID



SFDPA - 0662-08 - 000228



SFDPA - 0662-08 - 000229



SFDPA - 0662-08 - 000230



SFDPA - 0662-08 - 000231



PII



SFDPA - 0662-08 - 000233



SFDPA - 0662-08 - 000234



SFDPA - 0662-08 - 000235



SFDPA - 0662-08 - 000236



SFDPA - 0662-08 - 000237



PII

PII



SFDPA - 0662-08 - 000239



SFDPA - 0662-08 - 000240





SFDPA - 0662-08 - 000242

PII



R-50

PII





SFDPA - 0662-08 - 000245



SFDPA - 0662-08 - 000246



NISSAN

PII

CSI DR
OFF ON



PII









SFDPA - 0662-08 - 000252



SFDPA - 0662-08 - 000253



SFDPA - 0662-08 - 000254



SFDPA - 0662-08 - 000255



SFDPA - 0662-08 - 000256



SFDPA - 0662-08 - 000257



SFDPA - 0662-08 - 000258





SFDPA - 0662-08 - 000260

A close-up photograph of a white surface. At the top, there is a dark green, rounded rectangular object, possibly a window or a panel, with a silver-colored trim. Below this object, the numbers '53' are printed in a large, bold, dark blue font. The white surface has a slightly textured appearance.

53

SFDPA - 0662-08 - 000261

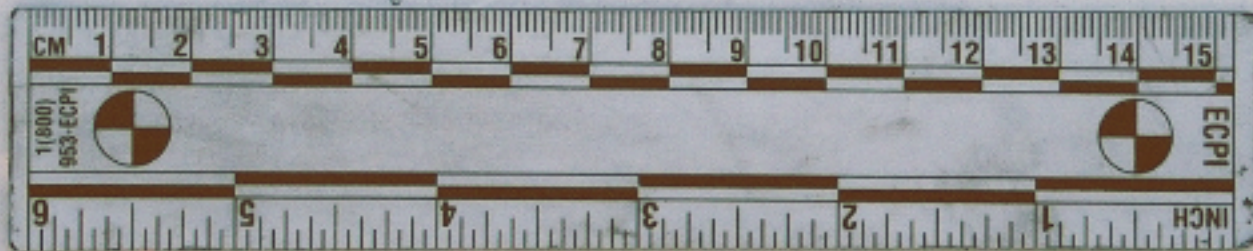
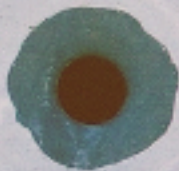

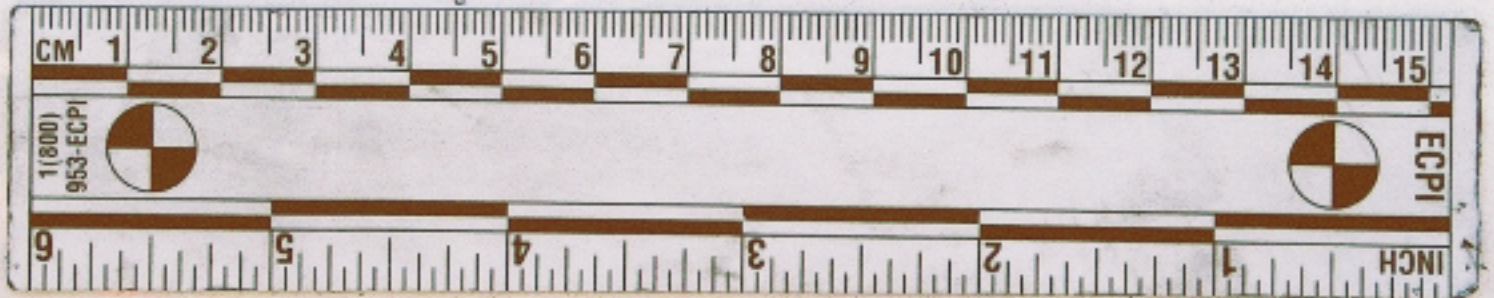
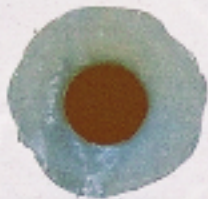



531

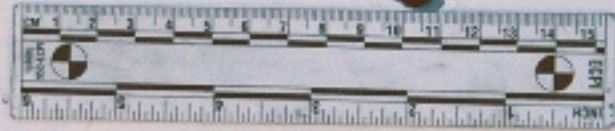

531



A close-up photograph of a white aircraft fuselage. The number "531" is printed in large, bold, black digits. To the left, a portion of a yellow and blue insignia is visible. Three circular rivets are scattered on the white surface. A chrome trim piece is visible at the top left.

531

PII



SFDPA - 0662-08 - 000268



SFDPA - 0662-08 - 000269



SFDPA - 0662-08 - 000270



SFDPA - 0662-08 - 000271

OFFICE OF CITIZEN COMPLAINTS

CITY AND COUNTY OF SAN FRANCISCO



NOTICE AND ORDER TO APPEAR OFFICER'S COPY

Joyce M. Hicks
Executive Director

TO: Commanding Officer/O.I.C., Records Management Division Station

FOR: Officer Dennis Cravalho #1783 AS: [REDACTED] POBRA

FROM: Sr. Investigator Dennis Maxson DATE: June 3, 2009 OCC Case No.: 0662-08

YOU ARE HEREBY NOTIFIED of your possible involvement in the above referenced complaint and ORDERED TO APPEAR at the Office of Citizen Complaints, located at 25 Van Ness Avenue, Suite 700, on the date and time indicated below for the purpose of providing a statement in this matter. If you are designated as a named member, it is your responsibility to arrange for representation, but in any event you are required to appear on time and be prepared to proceed. Bring field notes and any other materials relevant to this incident. **Failure to appear or personally provide at least 24 hours notice of a need to reschedule constitutes a violation of General Order 2.04 and may result in disciplinary action.**

June 11, 2009 @ 1400 hrs.
Date and Time of Interview

COMMANDING OFFICER: Serve and sign this Order when the member named above next reports for duty. If the member is on D.P. or extended sick leave but is medically able to appear, ensure that service is made on the member at his/her residence. Service may also be completed by phone with a notation made on the copy returned to OCC that telephone notification was made. If the member is designated as named, give a copy of this completed form and the attachments to the member. Witness members do not get a copy of the complaint, and none may be attached in that event. Return the original to the OCC with the next transfer of order. **If you are unable to serve the member you shall notify the OCC investigator by phone no later than (enter a date 48 hrs prior to date of appearance).**

COMMANDING OFFICER'S PROOF OF SERVICE:

Date received: _____ Reason for failure to serve or other comments: _____
Date/Time served: _____
Date returned to OCC: _____

Signature _____ Star No. _____

MEMBER'S ACKNOWLEDGMENT OF RECEIPT: Your signature acknowledges receipt of this notice and the following attachments: ____ Complaint Form ____ Added Allegation Form

Member's Signature Star No. Date and Time Notified

OFFICE OF CITIZEN COMPLAINTS

CITY AND COUNTY OF SAN FRANCISCO



NOTICE AND ORDER TO APPEAR PROOF OF SERVICE

Joyce M. Hicks
Executive Director

TO: O.I.C./Commanding Officer, Records Management Division.

FOR: Officer Dennis Cravalho #1783 AS: [REDACTED] POBRA

FROM: Sr. Investigator Dennis Maxson DATE: June 3, 2009 OCC Case No.: 0662-08

YOU ARE HEREBY NOTIFIED of your possible involvement in the above referenced complaint and ORDERED TO APPEAR at the Office of Citizen Complaints, located at 25 Van Ness Avenue, Suite 700, San Francisco, CA 94102 on the date and time indicated below for the purpose of providing a statement in this matter. If you are designated as a named member, it is your responsibility to arrange for representation, but in any event you are required to appear on time and be prepared to proceed. Bring field notes and any other materials relevant to this incident. **Failure to appear or personally provide at least 24 hours notice of a need to reschedule constitutes a violation of General Order 2.04 and may result in disciplinary action.**

June 11, 2009 @ 1400 hrs.

Date and Time of Interview

COMMANDING OFFICER: Serve and sign this Order when the member named above next reports for duty. If the member is on D.P. or extended sick leave but is medically able to appear, ensure that service is made on the member at his/her residence. Service may also be completed by phone with a notation made on the copy returned to OCC that telephone notification was made. If the member is designated as named, give a copy of this completed form and the attachments to the member. Witness members do not get a copy of the complaint, and none may be attached in that event. Return the original to the OCC with the next transfer of order. **If you are unable to serve the member you shall notify the OCC investigator by phone no later than (enter a date 48 hrs prior to date of appearance).**

COMMANDING OFFICER'S PROOF OF SERVICE:

Date received: _____
Date/Time served: _____
Date returned to OCC: _____

Reason for failure to serve or other comments:

Signature _____ Star No. _____

MEMBER'S ACKNOWLEDGMENT OF RECEIPT: Your signature acknowledges receipt of this notice and the following attachments: ____ Complaint Form ____ Added Allegation Form

Member's Signature Star No. Date and Time Notified

OFFICE OF CITIZEN COMPLAINTS
MEMBER INTERVIEW FORM

PRELIMINARY INFORMATION FOR THE RECORD:

1. This interview is regarding OCC case number 0662-08 and is taking place on
(Date & Time) 6/18/09 1205, at (Location) OCC
2. Conducting the interview is (Investigator) ~~GEORGE P. PATE~~
3. Also present is _____
4. The member being interviewed is (Name & Star No.) 1783
5. His/Her representative (or Attorney) is _____

ASK THE FOLLOWING QUESTIONS FOR THE RECORD:

1. (Title & Last Name) _____, have you read the statement of
(Complainant) _____, concerning an incident at
(Location) _____ on (Date & Time) _____? Yes No
A. (If Applicable) Have you read the OCC Added Allegation in this case? Yes No
2. Have you read General Order 2.08? Yes No
3. Have you read Rule 21 of General Order 2.01? Yes No
4. Have you read Section I.A. of General Order 2.04? Yes No
5. Do you understand these orders? Yes No
6. Are you prepared to be interviewed at this time? Yes No

CLOSING:

POBRA

3. The interview is concluded at (Time) _____
s:\invforms\memintv.doc

OFFICE OF CITIZEN COMPLAINTS

CITY AND COUNTY OF SAN FRANCISCO



RECEIVED
JUN 5 5 25 PM '09

NOTICE AND ORDER TO APPEAR PROOF OF SERVICE

Joyce M. Hicks
Executive Director

TO: O.I.C./Commanding Officer, Records Management Division.

FOR: Officer Dennis Cravalho #1783 AS: [REDACTED] POBRA

FROM: Sr. Investigator Dennis Maxson DATE: June 3, 2009 OCC Case No.: 0662-08

YOU ARE HEREBY NOTIFIED of your possible involvement in the above referenced complaint and ORDERED TO APPEAR at the Office of Citizen Complaints, located at 25 Van Ness Avenue, Suite 700, San Francisco, CA 94102 on the date and time indicated below for the purpose of providing a statement in this matter. If you are designated as a named member, it is your responsibility to arrange for representation, but in any event you are required to appear on time and be prepared to proceed. Bring field notes and any other materials relevant to this incident. **Failure to appear or personally provide at least 24 hours notice of a need to reschedule constitutes a violation of General Order 2.04 and may result in disciplinary action.**

June 11, 2009 @ 1400 hrs.
Date and Time of Interview

COMMANDING OFFICER: Serve and sign this Order when the member named above next reports for duty. If the member is on D.P. or extended sick leave but is medically able to appear, ensure that service is made on the member at his/her residence. Service may also be completed by phone with a notation made on the copy returned to OCC that telephone notification was made. If the member is designated as named, give a copy of this completed form and the attachments to the member. Witness members do not get a copy of the complaint, and none may be attached in that event. Return the original to the OCC with the next transfer of order. **If you are unable to serve the member you shall notify the OCC investigator by phone no later than (enter a date 48 hrs prior to date of appearance).**

COMMANDING OFFICER'S PROOF OF SERVICE:

Date received: Friday June 5, 2009 Reason for failure to serve or other comments:
Date/Time served: 10:41am, Friday June 5, 09
Date returned to OCC: 06-05-09
[REDACTED] 1410 Chief Clerk
Signature Star No.

MEMBER'S ACKNOWLEDGMENT OF RECEIPT: Your signature acknowledges receipt of this notice and the following attachments: Complaint Form Added Allegation Form

[REDACTED] 1783 06/5/09
Member's Signature Star No. Date and Time Notified

OFFICE OF CITIZEN COMPLAINTS

CITY AND COUNTY OF SAN FRANCISCO

July 15, 2009



Joyce M. Hicks
Executive Director

[Redacted] ID, PII

COPY

RE: OCC Case No. 0662-08

Dear [Redacted] ID:

The Office of Citizen Complaints has conducted an investigation of the above-referenced complaint. A summary follows of the OCC's **preliminary** finding as to each allegation:

The allegation of **Unnecessary Force** against a police officer for discharging a weapon at you without cause is **Proper Conduct**.

Please refer to the attached information for definitions of these findings. If you are not satisfied with the preliminary disposition indicated above, you have the right to request an investigative hearing on this complaint. (Please see information sheet, enclosed). The OCC strongly recommends that, to assist you in determining the grounds for a hearing, you call promptly to make an appointment with the investigator in your case, **Dennis Maxson** at **241-7711**, to discuss the preliminary findings and to review the evidence upon which the findings are based. Your written request for a hearing must be mailed or delivered within ten (10) days of the date that you receive this letter to the following address:

Office of Citizen Complaints
ATTN: Investigative Hearing Coordinator
25 Van Ness Avenue, Suite 700
San Francisco, CA 94102

As members of SFPD know, Department General Order 2.04 III. A.5.a. requires that, after OCC's investigation, including any investigative hearing, the OCC's investigation and findings as to sustained allegations shall be transmitted to the Chief of SFPD or the Chief's designee for review and action.

Sincerely,
PII

[Redacted Signature]

Joyce M. Hicks
Executive Director

JMH: gl
Attachment Enclosed

OFFICE OF CITIZEN COMPLAINTS

CITY AND COUNTY OF SAN FRANCISCO



July 15, 2009

Officer Dennis Cravalho #1783
Records Management

COPY

Joyce M. Hicks
Executive Director

RE: OCC Case No. 0662-08

Dear Officer Cravalho:

The Office of Citizen Complaints has conducted an investigation of the above-referenced complaint. A summary follows of the OCC's **preliminary** finding as to each allegation:

The allegation of **Unnecessary Force** for discharging a weapon at the complainant without cause is **Proper Conduct**.

Please refer to the attached information for definitions of these findings. If you are not satisfied with the preliminary disposition indicated above, you have the right to request an investigative hearing on this complaint. (Please see information sheet, enclosed). The OCC strongly recommends that, to assist you in determining the grounds for a hearing, you call promptly to make an appointment with the investigator in your case, **Dennis Maxson** at **241-7711**, to discuss the preliminary findings and to review the evidence upon which the findings are based. Your written request for a hearing must be mailed or delivered within ten (10) days of the date that you receive this letter to the following address:

Office of Citizen Complaints
ATTN: Investigative Hearing Coordinator
25 Van Ness Avenue, Suite 700
San Francisco, CA 94102

As members of SFPD know, Department General Order 2.04 III. A.5.a. requires that, after OCC's investigation, including any investigative hearing, the OCC's investigation and findings as to sustained allegations shall be transmitted to the Chief of SFPD or the Chief's designee for review and action.

Sincerely,
Pll



Joyce M. Hicks
Executive Director

JMH: gl
Attachment Enclosed
cc: Commanding Officer



SAN FRANCISCO POLICE DEPARTMENT REPORT MANAGEMENT

FAX TRANSMISSION RECORD

FAX NO: [415] 553-9848 VOICE NO: [415] 553-1038

Date: 9/11/2008

Agency Sent: OCC (0662-08) Fax No: 241-7733

Attention: INV. - MAXSON

Sent by: LIVINGSTON - #1080

Incident Report no: [REDACTED] ID

Comments: _____

Number of pages including cover sheet: 36

THIS PUBLICATION CONTAINS MATERIAL EXEMPT FROM PUBLIC DISCLOSURE. IT HAS BEEN DISCLOSED TO _____ FOR OFFICIAL PURPOSES. THE SAN FRANCISCO POLICE DEPARTMENT DOES NOT AUTHORIZE FURTHER DISCLOSURE.

OCC Routine Document Request

To: RMS

Date/Time: 09/11/2008 09:44 OCC Investigator: Dennis Maxson Phone #: 241-7762

SFPD Incident #: [REDACTED]

OCC Case #: 0662-08

Deliver Documents:

Fax OCC: 241-7733

25 Van Ness #700, 94102

Comments:

Please forward the following documents to the OCC. The documents requested are considered routine under the SFPD-OCC Document Production Protocol, which requires a response to this request within three (3) days. As required by the Protocol, this request has been sent concurrently to Police Legal.

- 12500 CVC Report (SFPD Form 164(a))
- 14601 CVC Report (SFPD Form 164)
- Academy training records
- Affidavit of Termination of Investigation (SFPD Form 470)
- Airport activity logs
- Anticipated Watch Report (SFPD Form 22)
- Arrest Record/Booking Slip (Form 3800-08)
- Candlestick Park activity logs
- Call Check Log (SFPD Form 51)
- Certificate of Release (SFPD Form 164)
- Citation log book records
- Citizen Arrest Form (SFPD Form 80)
- Citizen Complaint Investigation Memorandum
- Cold Show Admonishment (SFPD Form 466)
- Corrected Watch Report (SFPD Form 117)
- Court Protective Orders or Emergency Protective Orders
- DABOR reports (post-hearing)
- Daily Arrest logs (SFPD Form 307)
- Demonstration Memorandum (SFPD Form 77)
- Demonstration squad charts
- DMV Officer's Statement
- DMV Order of Suspension (Form 360 & 360(A))
- DMV Supplemental to Officer's Statement (Blood/Urine Test Results)
- DMV Traffic Accident Report Form
- DMV Verbal Notice by Police Officer
- Domestic Violence Response Unit Tapes
- Domestic Violence Supplemental Report forms (SFPD 480a & 480b)
- Driving Under the Influence Card (SFPD Form 482)
- Driving Under the Influence Report (SFPD Form 284A-D)
- Drug Influence Evaluation Report (SFPD Form 26)
- Drug Influence Evaluation Report (SFPD Form 26A & B)
- Event operation orders
- Field Arrest Card
- Field Interview Card (SFPD Form 114)
- Firearms Training Roster (SFPD Form 53)
- Fleet management records
- Hit and Run Record (SFPD Form 133)

- Incident Reports (including all supplemental reports)
- Intoxilizer Model 5000 Checklist (or other models)(SFPD Form 15)
- Line-up Record (SFPD Form 58)
- Media footage
- Medical Screening Form (SFPD Form 54)
- Mug Shots (criminal history information tracking number to be redacted)
- Notice of Motor Vehicle Accident (SFPD Form 326)
- Officer notes (Photocopies only)
- Officer's Daily Report (Traffic Division)(SFPD Form 108)
- Overtime and Holiday Watch Report (SFPD Form 238)
- AT&T Park activity logs
- Payroll records
- Permission to Search Form (SFPD Form 468)
- Photographic Line-up Instructions (SFPD Form 487)
- PLES (10-B assignment) rosters
- POST training materials
- Prisoner Transfer Record (SFPD Form 78)
- Property logs (from both stations and property control) (SFPD Form 230)
- Property Receipt Form (SFPD Form 315)
- Property Release Form (SFPD Form 156)
- Public Intoxication Report (SFPD Form 69)
- Ride-along Request and Review (SFPD Form 84)
- Roll call training logs
- Secondary Employment Application (SFPD Form 156)
- SFPD Dismissal Request (SFPD Form 256)
- SFPD officer photographs
- SFPD officer weight and height descriptions
- Station Arrest Logs
- Strip search authorization form (SFPD Form 305)
- Traffic Collision Reports (CHP555, 555-03 & 556)
- Traffic Court Report (SFPD Form 285)
- Unit orders
- Use of force logs (SFPD Form 128)
- Verification of latent fingerprint request (SFPD Form 235)(not including results)

OCC Routine Document Request

To: RMS

Date/Time: 09/11/2008 09:44 OCC Investigator: Dennis Maxson

Phone #: 241-7752

SFPD Incident #: [REDACTED]

OCC Case #: 0662-08

Comments:

Deliver Documents:

Fax OCC: 241-7733

25 Van Ness #700, 94102

RECEIVED
OCC

2008 SEP 12 P 2 05

Please forward the following documents to the OCC. The documents requested are considered routine under the SFPD-OCC Document Production Protocol, which requires a response to this request within three (3) days. As required by the Protocol, this request has been sent concurrently to Police Legal.

- | | |
|---|--|
| <input type="checkbox"/> 12500 CVC Report (SFPD Form 164(a)) | <input checked="" type="checkbox"/> Incident Reports (including all supplemental reports) |
| <input type="checkbox"/> 14601 CVC Report (SFPD Form 164) | <input type="checkbox"/> Intoxilizer Model 5000 Checklist (or other models)(SFPD Form 15) |
| <input type="checkbox"/> Academy training records | <input type="checkbox"/> Line-up Record (SFPD Form 56) |
| <input type="checkbox"/> Affidavit of Termination of Investigation (SFPD Form 470) | <input type="checkbox"/> Media footage |
| <input type="checkbox"/> Airport activity logs | <input type="checkbox"/> Medical Screening Form (SFPD Form 54) |
| <input type="checkbox"/> Anticipated Watch Report (SFPD Form 22) | <input type="checkbox"/> Mug Shots (criminal history information tracking number to be redacted) |
| <input type="checkbox"/> Arrest Record/Booking Slip (Form 3800-09) | <input type="checkbox"/> Notice of Motor Vehicle Accident (SFPD Form 325) |
| <input type="checkbox"/> Candlestick Park activity logs | <input type="checkbox"/> Officer notes (Photocopies only) |
| <input type="checkbox"/> Cell Check Log (SFPD Form 51) | <input type="checkbox"/> Officer's Daily Report (Traffic Division)(SFPD Form 106) |
| <input type="checkbox"/> Certificate of Release (SFPD Form 184) | <input type="checkbox"/> Overtime and Holiday Watch Report (SFPD Form 238) |
| <input type="checkbox"/> Citation log book records | <input type="checkbox"/> AT&T Park activity logs |
| <input type="checkbox"/> Citizen Arrest Form (SFPD Form 80) | <input type="checkbox"/> Payroll records |
| <input type="checkbox"/> Citizen Complaint Investigation Memorandum | <input type="checkbox"/> Permission to Search Form (SFPD Form 468) |
| <input type="checkbox"/> Cold Show Admonishment (SFPD Form 466) | <input type="checkbox"/> Photographic Line-up Instructions (SFPD Form 467) |
| <input type="checkbox"/> Corrected Watch Report (SFPD Form 117) | <input type="checkbox"/> PLES (10-B assignment) rosters |
| <input type="checkbox"/> Court Protective Orders or Emergency Protective Orders | <input type="checkbox"/> POST training materials |
| <input type="checkbox"/> DABOR reports (post-hearing) | <input type="checkbox"/> Prisoner Transfer Record (SFPD Form 78) |
| <input type="checkbox"/> Daily Arrest logs (SFPD Form 307) | <input type="checkbox"/> Property logs (from both stations and property control) (SFPD Form 230) |
| <input type="checkbox"/> Demonstration Memorandum (SFPD Form 77) | <input type="checkbox"/> Property Receipt Form (SFPD Form 315) |
| <input type="checkbox"/> Demonstration squad charts | <input type="checkbox"/> Property Release Form (SFPD Form 158) |
| <input type="checkbox"/> DMV Officer's Statement | <input type="checkbox"/> Public Intoxication Report (SFPD Form 69) |
| <input type="checkbox"/> DMV Order of Suspension (Form 360 & 360(A)) | <input type="checkbox"/> Ride-along Request and Review (SFPD Form 84) |
| <input type="checkbox"/> DMV Supplemental to Officer's Statement (Blood/Urine Test Results) | <input type="checkbox"/> Roll call training logs |
| <input type="checkbox"/> DMV Traffic Accident Report Form | <input type="checkbox"/> Secondary Employment Application (SFPD Form 156) |
| <input type="checkbox"/> DMV Verbal Notice by Police Officer | <input type="checkbox"/> SFPD Dismissal Request (SFPD Form 256) |
| <input type="checkbox"/> Domestic Violence Response Unit Tapes | <input type="checkbox"/> SFPD officer photographs |
| <input type="checkbox"/> Domestic Violence Supplemental Report forms (SFPD 480a & 480b) | <input type="checkbox"/> SFPD officer weight and height descriptions |
| <input type="checkbox"/> Driving Under the Influence Card (SFPD Form 462) | <input type="checkbox"/> Station Arrest Logs |
| <input type="checkbox"/> Driving Under the Influence Report (SFPD Form 284A-D) | <input type="checkbox"/> Strip search authorization form (SFPD Form 305) |
| <input type="checkbox"/> Drug Influence Evaluation Report (SFPD Form 26) | <input type="checkbox"/> Traffic Collision Reports (CHP555, 555-03 & 556) |
| <input type="checkbox"/> Drug Influence Evaluation Report (SFPD Form 26A & B) | <input type="checkbox"/> Traffic Court Report (SFPD Form 295) |
| <input type="checkbox"/> Event operation orders | <input type="checkbox"/> Unit orders |
| <input type="checkbox"/> Field Arrest Card | <input type="checkbox"/> Use of force logs (SFPD Form 128) |
| <input type="checkbox"/> Field Interview Card (SFPD Form 114) | <input type="checkbox"/> Verification of latent fingerprint request (SFPD Form 235)(not including results) |
| <input type="checkbox"/> Firearms Training Roster (SFPD Form 53) | |
| <input type="checkbox"/> Fleet management records | |
| <input type="checkbox"/> Hit and Run Record (SFPD Form 133) | |

From: Charles Gallman/OCC/SFGOV
To: Dennis Maxson/OCC/SFGOV@SFGOV

Date: Tuesday, February 03, 2009 04:28PM
Subject: Fw: Re: OCC case # 662-08

FYI

Charles R. Gallman
Chief Investigator
Office of Citizen Complaints
25 Van Ness Avenue, Suite 700
San Francisco, CA 94102
(T)415-241-7711
(F)415-241-7733
www.sfgov.org/occ

-----Forwarded by Charles Gallman/OCC/SFGOV on 02/03/2009 04:30PM -----

To: Charles Gallman/OCC/SFGOV@SFGOV
From: Daniel J Mahoney/SFPD/SFGOV
Date: 02/03/2009 04:18PM
cc: Jerry Tidwell/SFPD/SFGOV@SFGOV
Subject: Re: OCC case # 662-08

Charles,

Thank you for the "reminder". We have contacted Homicide Detail to find out the status of the files. Originally, they stated they may have been at the DA awaiting review (the Inspector was on leave when the original request came in). [REDACTED]

Dan

Lt. Daniel J. Mahoney
Legal Division
(415) 553-7929
San Francisco Police Department

CONFIDENTIALITY NOTICE: This communication and its contents may contain confidential and/or legally privileged information. It is solely for the use of the intended recipient(s). Unauthorized interception, review, use or disclosure is prohibited and may violate applicable laws, including the Electronic Communications Privacy Act. If you are not the intended recipient, please contact the sender and destroy all copies of the communication.
Charles Gallman

Charles Gallman To: Daniel J Mahoney/SFPD/SFGOV@SFGOV
cc: Dennis Maxson/OCC/SFGOV@SFGOV
Subject: OCC case # 662-08
02/03/09
16:15

Good afternoon Lt. Mahoney,

This message is intended to memorialize my request this afternoon wherein I asked that you look into a request that was made by Sr. Investigator Dennis Maxson of our office for department records relative to SFPD case # [REDACTED] on 12 Sept. 2008. On 30 Sept. 2008, you responded to our records requesting asking for a 30-day extension. We are renewing our request for records relative to our investigation.

We eagerly await your response.

Charles R. Gallman
Chief Investigator
Office of Citizen Complaints
25 Van Ness Avenue, Suite 700
San Francisco, CA 94102
(T)415-241-7711
(F)415-241-7733
www.sfgov.org/occ

OFFICE OF CITIZEN COMPLAINTS

CITY AND COUNTY OF SAN FRANCISCO



September 08, 2008

Joyce M. Hicks
Executive Director

ID, PII

RE: OCC Complaint Number 0662-08

Dear [REDACTED] ID

The Officer of Citizen Complaints (OCC) has received your complaint against members of the San Francisco Police Department. Before we conduct an interview with you, you should know that any statements you make to OCC may be discoverable in the criminal case currently pending against you. Therefore, it is advisable that you consult with your attorney before any interview takes place.

I would greatly appreciate if you or your attorney would contact me as soon as possible to discuss this matter. I can generally be reached Monday through Friday from 9:00 A.M. to 5:30 P.M. at (415) 241-7711.

Thank you for your attention to this matter.

Sincerely,

PII

Dennis A. Maxson
Senior Investigator

OFFICE OF CITIZEN COMPLAINTS

CITY AND COUNTY OF SAN FRANCISCO



Joyce M. Hicks
Executive Director

September 12, 2008

Lt. Daniel Mahoney
Commanding Officer
Legal Division
San Francisco Police Department
850 Bryant Street, Room 575
San Francisco, CA 94103

Via Facsimile: 553-7307

RE: **OCC Case No. 0662-08**
SFPD Case No. [REDACTED] ID

Dear Lt. Mahoney;

The Office of Citizen Complaints is conducting an investigation of the above referenced OCC complaint. This complaint concerns an officer-involved shooting that occurred in the Taraval District on May 19, 2007. In connection with this investigation, we are requesting all material evidence gathered by the SFPD during the course of its investigation, including, but not limited to:

- Transcripts, notes of interviews and audio and video tapes of all interviews
- Crime Scene Reports and diagrams
- Photographs—all sources
- Videos—all sources
- Crime Lab analyses and reports
- Ballistics and Firearms reports
- Latent Fingerprint reports
- Bloodstain analysis reports
- Gunshot residue examination reports
- DNA analysis reports
- Property logs
- Evidence photographs
- Crime Scene Log
- Inspectors' Chronos

Post-it® Fax Note	7671	Date	9/12/08	# of pages	2
To	Lt. Mahoney	From	M. R. X. S. M.		
Co./Dept.	Legal	Co.	OCC		
Phone #		Phone #	241-7752		
Fax #	553-7307	Fax #	241-7733		

The requested documents, materials, and access to evidence are relevant and necessary for the OCC to conduct its investigation. Should there be any questions or concerns about this request, please do not hesitate to call me at (415)241-7752.

Thank you for your cooperation with this matter.

Sincerely,

PII

Dennis Maxson
Senior Investigator



GAVIN NEWSOM
MAYOR

POLICE DEPARTMENT
CITY AND COUNTY OF SAN FRANCISCO

THOMAS J. CAHILL HALL OF JUSTICE
850 BRYANT STREET
SAN FRANCISCO, CALIFORNIA 94103-4603



HEATHER J. FONG
CHIEF OF POLICE

September 30, 2008

Dennis Maxson
Investigator
Office of Citizen Complaints
25 Van Ness Avenue, Suite 700
San Francisco, California, 94102

Re: OCC Case No: 662-08

Dear Investigator Maxson:

On September 12, 2008, I received your non-routine request for fourteen (14) separate items relating to an officer-involved-shooting re: IR [REDACTED] ID [REDACTED]. At this time, the investigating officer is off on leave and we are unable to access those documents for production. We are requesting a 30-day extension to October 30, 2008 at which time we expect to provide you with the requested documents.

Direct any additional questions regarding this matter to me at (415) 553-1511.

Sincerely,

[REDACTED] PII

LT. DANIEL J. MAHONEY
Commanding Officer
Legal Division

Letters08/DennisMaxsonOCC662-089-30-08/KW/gb

SFDPA - 0662-08 - 000286

Attempted murder charges for suspect in officer shootout

Rachel Gordon, Chronicle Staff Writer
Tuesday, May 22, 2007

(05-22) 17:14 PDT SAN FRANCISCO -- A man who San Francisco police say opened fire on two officers responding to a reported bicycle theft over the weekend was charged today with two counts of attempted murder.

Francisco Valle, 50, also faces felony burglary and firearms charges, and if convicted could spend life in prison. He was arraigned today in San Francisco Superior Court, where bail was set at \$1 million. He remains in custody.

Police say they received a call early Saturday from a resident on the 2000 block of the Great Highway who reported that a man was in the building's garage stealing a bicycle. When officers arrived at the scene, they spotted the suspect on the bicycle and confronted him, according to police accounts. Police say the suspect fired at the officers and missed, but hit their patrol car. One of the officers returned fire, hitting Valle, who then fled. He was found later hiding in some bushes at Santiago Street and the Great Highway, according to police.

Valle was treated for minor injuries. The two officers also sustained minor injuries when they dove for cover.

Valle, who police say lived in San Francisco and Daly City, is scheduled to return to court Thursday to enter a plea.

E-mail Rachel Gordon at rgordon@sfchronicle.com.

<http://sfgate.com/cgi-bin/article.cgi?f=/c/a/2007/05/22/BAGHKPVL9H5.DTL>

San Francisco Chronicle Sections

Go

© 2007 Hearst Communications Inc. | [Privacy Policy](#) | [Feedback](#) | [RSS Feeds](#) | [FAQ](#) | [Site Index](#) | [Contact](#)



SAN FRANCISCO

Police arrest man in bike theft, shooting

Rachel Gordon

Wednesday, May 23, 2007

A man who allegedly opened fire on two San Francisco police officers who were responding to a reported bicycle theft over the weekend was charged Tuesday with two counts of attempted murder.

Francisco Valle, 50, also faces felony burglary and firearms charges, and if convicted could spend life in prison. He was arraigned Tuesday in Superior Court, where bail was set at \$1 million. He remains in custody.

Police say they received a call early Saturday from a resident on the 2000 block of the Great Highway who reported that a man was in the building's garage stealing a bicycle. When officers arrived at, they spotted the suspect on the bicycle and confronted him, according to police accounts.

Police say the suspect fired at the officers and missed, but hit their patrol car. One of the officers returned fire, hitting Valle, who fled. He was found later hiding in some bushes at Santiago Street and the Great Highway, according to police.

Valle was treated for minor injuries. The two officers also sustained minor injuries when they dived for cover. Valle, who police say lived in San Francisco and Daly City, is scheduled to return to court Thursday to enter a plea.

<http://sfgate.com/cgi-bin/article.cgi?f=/c/a/2007/05/23/BABADIGEST2.DTL>

This article appeared on page **B - 3** of the San Francisco Chronicle

San Francisco Chronicle Sections

Go

© 2007 Hearst Communications Inc. | [Privacy Policy](#) | [Feedback](#) | [RSS Feeds](#) | [FAQ](#) | [Site Index](#) | [Contact](#)

ONLINE DEGREES
 Click here for
 Top Online Schools

Choose From:

- ▶ Associate's Programs
- ▶ Bachelor's Programs
- ▶ Certificate Programs
- ▶ Doctoral Programs
- ▶ M.B.A. Programs
- ▶ Master's Programs



EarnMyDegree

ATTORNEY SEARCH

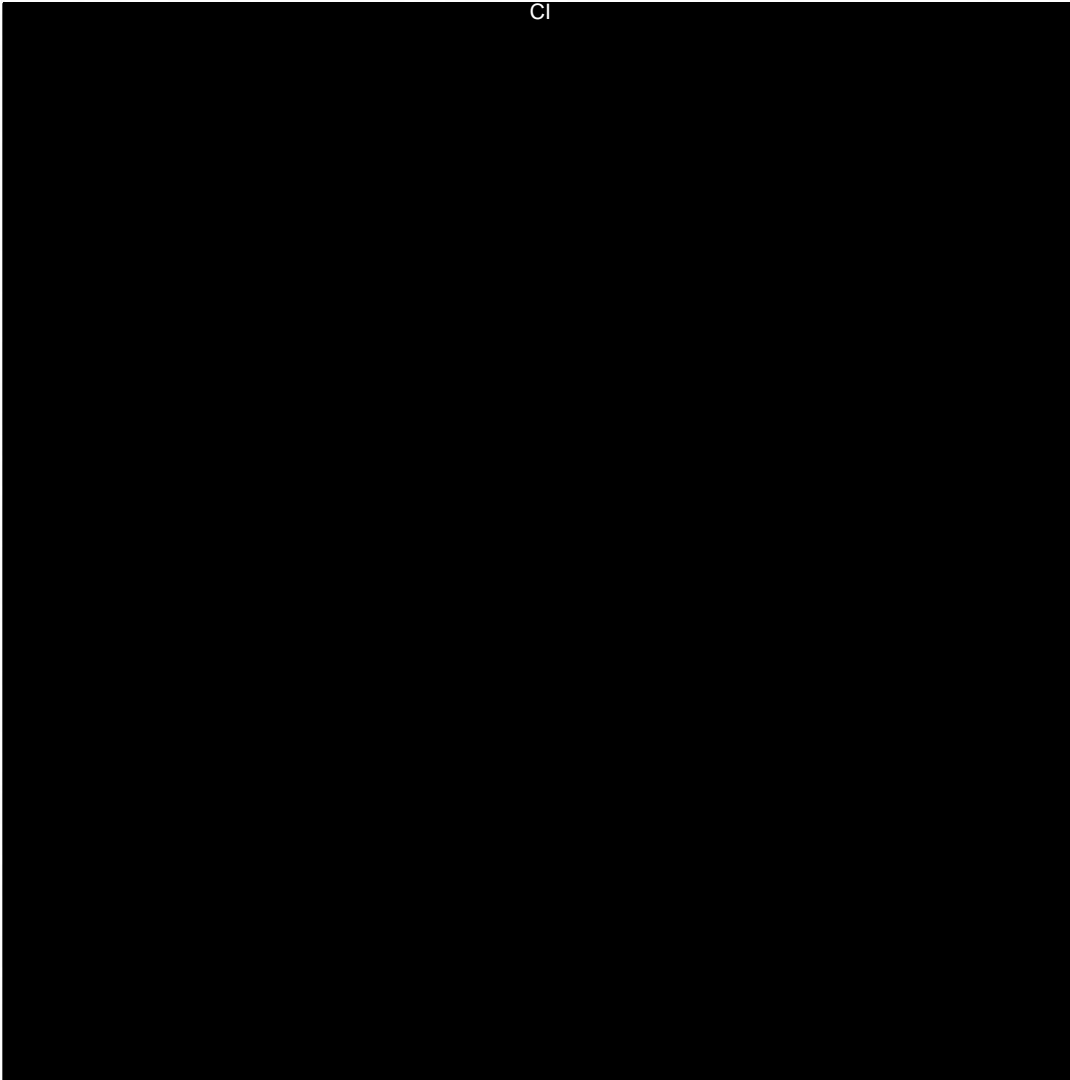

[Start New Search >](#)

CLM 9/15/08 11:00

Dennis Maxson
Investigator
Office of Citizen Complaints
25 Van Ness Avenue, Suite 700
San Francisco, California, 94102

SFDPA - 0662-08 - 000290

ID

Office of Citizen Complaints
25 Van Ness Avenue, Suite #700
San Francisco, CA 94102

SFDPA - 0662-08 - 000291

COMPLAINT WORK SUMMARY

C # 0662-08
 NAME [REDACTED] ID [REDACTED]
 INV. [REDACTED]
 PAGE # 1 of [REDACTED]

DATE	ACTIVITY
8/18/08	COPY OF THE DRB FWD'D TO ADMIN. J
8/20/08	- Rem CAD, QIR, QALL-
9/8/08	- Ltr. to comp re: legal advice prior to interview
9/11/08	Rec'd IR ✓
9/12/08	- Evidence report to legal
9/20/08	Ltr. from legal - postponing discovery of Homicide File to 10/30/08
11/15/08	- Advise CG to ✓ in w/ legal re: Homicide file
11/20/08	- Another postponement 30 days from legal
2/3/09	e-mails to/from CG to legal; still waiting for Homicide files
5/14/09	- wants went to Homicide - retrieved files

OFFICE OF CITIZEN COMPLAINTS
COMPLAINT WORK SUMMARY

OCC CASE #: 662-08
NAME: _____
INV: _____
PAGE: 2

=====

DATE & ACTIVITY (DATE & SIGN AFTER FINAL ENTRY ON EACH PAGE)

5/21/09: Analysis of Homicide records:

Crime Scene diagrams, ballistics reports, Homicide chron's, photos, and tape of Ofc. Cravalho's Homicide interview all indicate that Ofc. Cravalho was only officer who fired. Ballistics form comp's gun and GSR tests proved comp. fired several shots, at least four of which struck the patrol car.

06/03/08-NTA to Ofc. Cravalho for interview 06/11/09 1400 hrs.

06/05/09: Rc's POS for Ofc. Cravalho

06/08/09: P/C from Steve Johnson-re-scheduled Cravalho int. to 06/18/09 1200 hrs.

06/18/09 Interview w/ Ofc. Dennis Cravalho #1783-Lydia Stiglich, Atty.:

Ofc. Cravalho, in uniform and in a marked unit with Ofc. Paolo Morgado #466, 3I16E, responded as back-up to a call of a man on a stolen bicycle in the area of Great Highway and Taraval. They were heading N/B on Lower Great Hwy. from Sloat when they saw a man fitting the description of the suspect riding a bike S/B in the middle of Lower Great Hwy. near Taraval. The man saw them and immediately went up onto the sidewalk. Ofc. Cravalho, who was in the passenger seat with the window down, asked the man to stop so they could talk to him, but the man took off S/B down the sidewalk. Ofc. Morgado put the car in reverse and caught up with the man. Again, Ofc. Cravalho ordered the man to stop. The man got off the bike and ran. Ofc. Cravalho got out of the radio car and gave chase on foot. The man ran behind a parked minivan. Ofc. Cravalho approached the minivan from the rear with his service revolver at low ready. He saw the man crouched near the front of the minivan.

The suspect did not see Ofc. Cravalho. He appeared to be focused on the patrol car. As Ofc. Morgado drove the patrol car up onto the curb in front of the minivan, facing W/B, the man stood up, raised a gun and "lit up" the patrol car with gunfire. Ofc. Cravalho called out shots fired on the radio and the man looked around with a look of "What the f...k?" and came at Ofc. Cravalho with his gun pointed at him. Ofc. Cravalho fired several shots at the suspect, shattering the windows of the minivan. As the suspect drew closer, Officer injuring his knees and cutting arms on the broken glass from the minivan's shattered windows. The suspect stood right over him and Ofc. Cravalho though he would

OFFICE OF CITIZEN COMPLAINTS
COMPLAINT WORK SUMMARY

OCC CASE #: 502-08
NAME: _____
INV: _____
PAGE: 3

=====

DATE & ACTIVITY (DATE & SIGN AFTER FINAL ENTRY ON EACH PAGE)
shot, but the suspect just stood there. Ofc. Carvalho got up, ran across the street and jumped over the hood of a parked car, where he saw his partner hiding behind the car. He reloaded, looked up, saw the suspect running off and gave chase, but the suspect got away. He heard sirens approaching. He decided to stop running after the suspect because he did not want to get ambushed, so he waited and set up a perimeter until the other officers arrived.

Officer Cravalho later learned that, when the suspect shot at Ofc. Morgado in the patrol car, Ofc. Morgado got out and ran for cover across the street, and that he was also injured when he dove for cover. Ofc. Cravalho also learned later that one of his shots had struck and disabled the suspects magazine, causing his gun to malfunction, which probably saved Ofc. Cravalho's life.

CI

It should be noted that the complainant was not interviewed. I spoke to him several times (he is in PII facing charges in this matter.) I advised him he should not speak to OCC until he has consulted with his attorney. I spoke to his attorney, Jonathan McDougall, PII, who advised me he declined to have his client speak to OCC pending his criminal trial.

Recommended finding:

UF for discharging a weapon: (Ofc. Dennis Cravalho #1783) the complainant stated the officers fired at him for no reason. the investigation proved the officer fired when the complainant fired upon the patrol car and turned the weapon on the officer. The officer's conduct was lawful, proper, an necessary. **Proper Conduct.**

CSR prepared for closure.

PII

07/03/2009

OCC # 662-08

COMPLAINT WORK SUMMARY NAME _____

INV. _____

PAGE # 7 of _____

DATE	ACTIVITY
7/6/09	Update the 293 listing the named member, complete the CSR with allegation + proposed findings. Indicate on the 293 that you were the assigned investigator, submit updated 293 to admin, returned to me for closure. <div data-bbox="1006 819 1234 945" style="background-color: black; color: white; text-align: center; padding: 2px;">PII</div>
7/13/09	- Updated Allegation Cont. Form already submitted: in database - copy to file - CSR corrected = updated 293 to Admin
7/13/09	Close as proposed <div data-bbox="795 1302 1023 1386" style="background-color: black; color: white; text-align: center; padding: 2px;">PII</div>
7/14/09	File to admin. <div data-bbox="795 1449 958 1554" style="background-color: black; color: white; text-align: center; padding: 2px;">PII</div>
7/16/09	Resubmit <div data-bbox="876 1575 1088 1596" style="background-color: black; color: white; text-align: center; padding: 2px;">PII</div>
7/20/09	Cancel w/ CTR <div data-bbox="876 1575 1088 1701" style="background-color: black; color: white; text-align: center; padding: 2px;">PII</div>

1 DEPARTMENT OF POLICE ACCOUNTABILITY

2 DPA CASE NO.: 0662-08

3

4 INTERVIEW OF: OFFICER PAULO MORGADO, #466

5 DATE OF INTERVIEW: 05/19/2007

6

7

8 INSPECTOR DAN: This is Dan. Today's date is May 19, 2007.

9 The time is 08:20 hours. Continuing investigation into [REDACTED] ID

10 [REDACTED] ID And the person who is being interviewed is-

11 OFFICER PAULO MORGADO: Officer Morgado, M-O-R-G-A-D-O, star
12 466.

13 DAN: Okay.

14 FEMALE: [Unintelligible]

15 DAN: [Unintelligible], SFPD.

16 INSPECTOR MIKE PHILPOTT: Inspector Mike Philpott, star
17 number 65, Homicide Detail.

18 FEMALE: [Unintelligible].

19 MALE: [Unintelligible] District Attorney's Office.

20 GAN: Okay. All right, ah, M-O-R-G-A-D-O, right?

21 MORGADO: Correct.

22 GAN: And what's your first name?

23 MORGADO: Paulo, P-A-U-L-O.

24 GAN: And star number one more time?

25 MORGADO: 466.

26 GAN: And what's your date of birth?

27 MORGADO: PII [REDACTED]

28 GAN: And what was your date of entry into the Police

1 Department?

2 MORGADO: POBRA 01.

3 GAN: And I see you work in uniform. [Unintelligible]

4 you're working in uniform last night?

5 MORGADO: Yes.

6 GAN: Okay. And what unit were you working last night?

7 MORGADO: We were the 3-Ida-16-Edward.

8 GAN: And you know what car you were driving?

9 MORGADO: 531.

10 GAN: And who were you working with?

11 MORGADO: Dennis Cravalho.

12 GAN: And did you fire your firearm last night?

13 MORGADO: No.

14 GAN: Did not.

15 MORGADO: No.

16 GAN: Okay. Okay, why don't you tell me ah, how you were

17 involved in which your partner fired his weapon. Why don't you

18 go ahead and tell us what occurred last night [unintelligible]

19 incident?

20 MORGADO: We were backing a unit up to a 459 of a bike out

21 of- I don't know if it was out of a garage or a home or whatnot

22 but it was a 459 of a bike. And the victim's husband was

23 following the guy, chasing the guy with his dog.

24 GAN: Uh huh.

25 MORGADO: Southbound -southbound Great Highway from Pacheco.

26 So, we were driving -we were coming from the [unintelligible]

27 which was like that area, and we decided to go up from Sloat-

28 Great Highway- the lower Great Highway, and-

1 GAN: And you're driving the car?
2 MORGADO: I was driving.
3 GAN: Okay.
4 MORGADO: When we get up to -it was Taraval and lower Great
5 Highway, and it splits off to- the street splits off if you keep
6 going staying to the left, it's lower Great Highway still. If
7 you split off to the right turns into 48th Ave at which time I
8 saw a male- which appeared to me a male, on a bicycle in the
9 middle of the road on 48th, about 200 - 200 or 300 feet from
10 Taraval. And I told Dennis, hey, there's the guy on the bike
11 over there. So, I veered to the right onto 48th and at that
12 time, the guy made it way up onto the sidewalk, to the eastside
13 of the sidewalk. As we drove by, we were driving by just looking
14 at to see if, you know, the guy matched the description- looked
15 and ah- the description of the bike was a silver bike and at that
16 time, the male looked at us and started pedaling really fast
17 southbound. So, kinda figured it was him. So, I put the car in
18 reverse, drove backwards to Taraval- back to Taraval to the
19 corner. Dennis said, hey, let me out here. I let Dennis out of
20 the vehicle there and that's when the male -there was a van
21 parked about a hundred feet I would guess -plus or minus- on the
22 eastside of the street. The guy got off the bike and was behind
23 the ah, passenger door, front door of the car. So, it looked
24 like he was gonna run northbound 'cause he turned back facing
25 northbound a little bit. So, I took my vehicle and drove it
26 around the van in front to see if I could block him off since
27 Dennis was coming around from the other side of the van.
28 GAN: Um hmm.

1 MORGADO: I heard Dennis call the Code 33 and as I was
2 coming around, I see the guy reaching in his waistband, come up
3 and shots started going. So, I tried to throw the car into park.
4 I don't know what gear it went into but the car wasn't stopping
5 so I just opened the door and bailed. Um, when I bailed, I could
6 feel the shots hitting the pavement next to me. And actually,
7 saw some of the shots hit the pavement. Um, so I'm just crawling
8 as fast as I can across the street to get in cover against the -
9 a parked car.

10 GAN: Uh huh.

11 MORGADO: I got to across the street and I went into the
12 wheel-well area of the front of the vehicle to get behind the
13 engine block. At that time, I can hear -the shots are still
14 going off. I can hear ah- I can hear the difference in the
15 gunshots because his caliber was a lot lower so it was making
16 less of a bang. So, I heard when Dennis went dry 'cause I heard
17 him pulling the trigger and it was just going, click, click,
18 click, and I yelled out, Dennis, take cover. And I didn't know
19 where he was at but a couple seconds later, I see him dive behind
20 the same vehicle that I was behind. Um, at that time, I had, you
21 know, I said- I asked him, I was like, are you shot? He goes,
22 no. He asked me the same thing. Said, no. And then he said,
23 the guy's running. So, I pop up on the driver's side of that
24 vehicle up in the front area. Didn't see where he took off and
25 Dennis said, he's going Taraval, he's going Taraval. All of a
26 sudden, Dennis takes off running and I see Dennis' magazine is on
27 the ground right where he was at. And there were- one of them
28 was fully loaded so I was thinking Dennis reloaded his gun with

1 one of the empty magazines that he was using. So, I grabbed his
2 magazine. Um, went to the car, grabbed the key to the car, took
3 off running behind Dennis. Dennis was about one block away.
4 When Dennis was at 47th, I was mid-block and the he started
5 yelling the guy's ducking behind the vehicle on 47th. That's
6 when we, you know, we were trying to see if ah, [unintelligible]
7 and that's pretty much it.

8 GAN: Okay. Okay. Let's go back and we'll get a little bit
9 more- a few more details. So, you hear your call come up and you
10 go to back up somebody on a 459?

11 MORGADO: Correct.

12 GAN: And you hear your [unintelligible] anybody that came
13 out, any suspects?

14 MORGADO: I heard the- the description I heard was possibly
15 a white male, one of them.

16 GAN: Uh huh.

17 MORGADO: And that he was wearing all dark clothing. And he
18 was on a- still on the silver bike riding southbound on ah, on
19 Great Highway.

20 GAN: From where?

21 MORGADO: From Pacheco.

22 GAN: Okay. And you guys were just coming from where?

23 MORGADO: We were coming from - well, I made a right on
24 Sloat onto lower Great Highway.

25 GAN: Okay. And now you're driving northbound on the lower
26 Great Highway.

27 MORGADO: Correct.

28 GAN: And you come to Taraval, where at Taraval, that's

1 towards lower Great Highway and 48th has kinda like that split at
2 48h Avenue and -
3 MORGADO: Correct.
4 GAN: All right. And when you get to that point, what do
5 you see?
6 MORGADO: I see a male riding a bike southbound about 300
7 hundred feet in from Taraval on 48th.
8 GAN: On 48th.
9 MORGADO: Right.
10 GAN: And like in the street or -
11 MORGADO: In the middle of the street.
12 GAN: In the middle of the street.
13 MORGADO: Right.
14 GAN: Okay. Ah, could you tell what he was wearing at that
15 time?
16 MORGADO: Ah, I could see dark clothing.
17 GAN: Dark clothing?
18 MORGADO: And I did see a black hat. I don't know if it was
19 black but it was a dark hat. To me, it looked like he had longer
20 hair because the hat looked like it had some type of latch on it,
21 on the back, but I'm not too sure.
22 GAN: And you kinda like pointed to the ears?
23 MORGADO: Yeah 'cause I could see-
24 GAN: Lower part-
25 MORGADO: The ears- I could see something, you know,
26 sticking out from the hat. I don't - I - I assumed it was hair,
27 you know.
28 GAN: Okay.

1 MORGADO: Somebody wears hair- they have longer hair- the
2 hair sticks out.

3 GAN: Okay. All right. So, you see him coming out. You
4 tell Dennis?

5 MORGADO: Yeah. I tell Dennis, hey, there's the- that's the
6 - that's probably the guy right there.

7 GAN: Okay.

8 MORGADO: And so, we veered off to the - to the right onto
9 48th Ave. and as soon as I went onto 48th Ave., the guy riding the
10 bike went up onto the sidewalk.

11 GAN: Okay. But before he went on the sidewalk, did you
12 guys yell at him to stop or anything?

13 MORGADO: No.

14 GAN: Okay.

15 MORGADO: No.

16 GAN: All right. So, he goes on the sidewalk and how fast
17 was he pedaling on the bike?

18 MORGADO: At that time, he was just pedaling slow and then
19 I- when I was driving by- 'cause we didn't know if it was him or
20 not, so I decided to drive slow by him-

21 GAN: Uh huh.

22 MORGADO: And right when we were slowing down, he looked at
23 us and just started pedaling as fast as he can.

24 GAN: Did either you or ah, Dennis yell at the guy to stop
25 or anything at that point?

26 MORGADO: Dennis was yelling out the window. I don't recall
27 what he was yelling but he was yelling.

28 GAN: Dennis was yelling at the guy?

1 MORGADO: Yeah.

2 GAN: [Unintelligible] the bike. Was anybody else around
3 besides you three? You, Dennis and the guy on the bike?

4 MORGADO: I didn't see anybody else around.

5 GAN: Was anybody driving around or anything?

6 MORGADO: I didn't see anybody else driving.

7 GAN: Okay, so now he's on the sidewalk and the sidewalk-
8 which sidewalk are we talking about? The eastside or the
9 westside?

10 MORGADO: Eastside of 48th Ave.

11 GAN: Okay. And what happens next?

12 MORGADO: I put it in reverse. As soon as he starts coming
13 real fast, um, at that time, I put it in reverse and I reversed
14 it all the way back to Taraval, the corner of Taraval and ah,
15 48th.

16 GAN: Okay. Now when you put it in reverse, that's when you
17 first come up to the guy and the guy- does the guy go by you>

18 MORGADO: Yeah. He rides by us.

19 GAN: Did you get a good look at his face or anything?

20 MORGADO: Ah, he - he- to me, he looked like a mixture of
21 white and Latin, Hispanic mix.

22 GAN: Okay.

23 MORGADO: Um, he wasn't that dark skinned. He was probably
24 my skin tone.

25 GAN: Um hmm.

26 MORGADO: Um, with a black jacket, dark pants and then the
27 hat. I saw the hat. A black hat.

28 GAN: Any emblems or anything on the hat? Do you remember?

1 MORGADO: I didn't see any emblems on the- I don't remember
2 if there was any.

3 GAN: Could it been you just didn't [unintelligible]?

4 MORGADO: Yeah.

5 GAN: Okay. All right. So now you back the car up to 48th
6 and then what happens? I mean you back up to Taraval. I'm
7 sorry.

8 MORGADO: When ah- backed up, Dennis goes, hey, let me out,
9 let me out right here. So, he opens up, gets out of the vehicle
10 and exits to the sidewalk area to the eastside. And so, at that
11 time, the guy ducks behind the minivan that's parked in front.

12 GAN: Now do you see that when you're still stopped or you
13 starting to go forward or what happened?

14 MORGADO: Yeah. Yeah. I did see that. I see him get off
15 the bike.

16 GAN: So, he stops to get off the bike.

17 MORGADO: Get off the bike-

18 GAN: Is that when Dennis got out of the car?

19 MORGADO: Right. Saw him get off the bike and it looked
20 like he was gonna run northbound.

21 GAN: Northbound on 48th.

22 MORGADO: On 48th.

23 GAN: Okay.

24 MORGADO: Dennis puts out- he goes, Code 33, foot ah, foot
25 pursuit. The guy's running northbound on 48th. The guy turns,
26 he ducks down and as I'm pulling the vehicle around, that's when
27 I see his hand go into his waistband and he's like-

28 GAN: What hand?

1 MORGADO: It was his right hand went into his waistband.
2 GAN: Into his waistband. Was the jacket unzipped already
3 or he had to lift his jacket up or what happened?
4 MORGADO: His jacket was unzipped.
5 GAN: Okay.
6 MORGADO: From what I remember 'cause I remember seeing him
7 with his- when he went up and then came back down and then came
8 back up with a gun, I saw it was open.
9 GAN: You know what kind of jacket it was?
10 MORGADO: No.
11 GAN: You know what color it was?
12 MORGADO: It was black.
13 GAN: Was it like a windbreaker or a thin jacket or like a
14 down jacket?
15 MORGADO: It wasn't a down jacket. It wasn't one of those
16 puffy jackets. It was -it just looked like a regular black
17 jacket. Like it came down to the waist area.
18 GAN: Okay. All right. So, he comes out with what kind of
19 gun?
20 MORGADO: Ah, it looked like a handgun. And ah, to be
21 honest with you, I don't know what type of gun. I didn't see the
22 gun that closely.
23 GAN: Okay. And where exactly are you when you saw the gun?
24 MORGADO: I'm in the vehicle.
25 GAN: Uh huh.
26 MORGADO: Coming around the front end of the van.
27 GAN: So, you're pulling up to the sidewalk?
28 MORGADO: Right.

1 GAN: Okay. Then what happened?

2 MORGADO: Ah, when he- the guy comes up, he points the gun
3 at me. Starts taking rounds off at the car.

4 GAN: While you're in the car?

5 MORGADO: While I'm in the car.

6 GAN: Did you hear the car get hit?

7 MORGADO: I heard the car -something get hit. I didn't know
8 if it was the car. My car, I didn't know.

9 GAN: You heard some kind of bullets [unintelligible].

10 MORGADO: Right. And the windows were down and I actually
11 heard a bullet go by.

12 GAN: Was this guy looking right at you when he was doing
13 it?

14 MORGADO: He was -yeah. He was-

15 GAN: Pointing right at you?

16 MORGADO: Pointing right at me and shooting right at me.

17 GAN: Okay. Do you know how many times he fired at that
18 point?

19 MORGADO: At that point, he had to have let off at least
20 five rounds.

21 GAN: Okay.

22 MORGADO: Um, 'cause I - I could hear it go, you know, pop,
23 pop, pop, pop, pop. And he just kept on shooting. Um, when- at
24 that time, when the shots were going, like I said, I tried to put
25 it into park and the last thing I remember was the car was still
26 going and I said, forget this, opened up the door and bailed out.

27 GAN: Okay so let's clear it up right up now so I don't
28 forget. You came back and got the keys eventually, right?

1 MORGADO: Yeah.

2 GAN: Did you just put the car into park and get the keys
3 out?

4 MORGADO: I don't remember. I don't remember.

5 GAN: Okay. All right. Then let's go back. So, now you're
6 -you're getting out of your car.

7 MORGADO: Um hmm.

8 GAN: Okay. What -what happened next?

9 MORGADO: I- I hit the pavement. Um, and then I just
10 thought I- I stayed low to the ground and I did like a crawl-
11 running motion on the ground, you know, my feet up but my hands
12 on the ground and still just low to the ground.

13 GAN: Uh huh.

14 MORGADO: And as I'm trying to go across, I can see a couple
15 of bullets hit the pavement.

16 GAN: So, rounds are still being fired at you?

17 MORGADO: Yeah.

18 GAN: Okay. All right. Then what happened?

19 MORGADO: And I heard- I heard Dennis shooting because his
20 gun was louder. And -

21 GAN: Let me ask you a question. So, you heard the
22 different sound of the firearm?

23 MORGADO: Yes.

24 GAN: Okay. When - when was the first time you heard what
25 you believed were sounds of Dennis' gun being fired? Where were
26 you at?

27 MORGADO: When I hit the pavement the first time, ah, that's
28 when I heard Dennis' gun go off. When I -when I opened up the

1 door and hit the pavement.

2 GAN: So, after you got out of the car and hit the pavement-

3 MORGADO: Yeah.

4 GAN: You hear-

5 MORGADO: That's when I heard Dennis' gun go off.

6 GAN: Okay. Ah, and you heard -and you saw something

7 striking the ground?

8 MORGADO: Yeah.

9 GAN: And do you know whose rounds those were by any chance

10 by the sound?

11 MORGADO: Well, I saw the rounds hitting the ground when I

12 was across, like almost across the street. I was in the middle

13 of the street crawling.

14 GAN: Oh, okay.

15 MORGADO: And so they were -when I was going across the

16 street, I felt the rounds come- a couple of rounds hit the ground

17 next to me.

18 GAN: When you're getting out of the car, you're crawling on

19 the pavement and eventually you make it across the street to the

20 car?

21 MORGADO: Right.

22 GAN: How long did that take for that to occur?

23 MORGADO: Seconds.

24 GAN: Okay. Now you get across the street. And when you

25 get across -while you're moving across the street, do you still

26 hear shots being fired?

27 MORGADO: Yes.

28 GAN: Okay. Now you're at the back of the car or in front

1 of the car?

2 MORGADO: I'm at the front of the wheel.

3 GAN: Oh, by the engine block.

4 MORGADO: Right.

5 GAN: That's right, I'm sorry. And you still hear gunshots,
6 from both different sounds of the guns?

7 MORGADO: From both guns, yeah.

8 GAN: Okay. Then what happens next?

9 MORGADO: Ah, I hear Dennis' gun go dry and I hear him still
10 pulling the trigger and it was going, click, click, click, click.

11 GAN: And how do you know it was Dennis' gun?

12 MORGADO: Because -well, I kinda figured it was him. I
13 don't know for sure if it was his.

14 GAN: Well let's put- let me ask you another question. You
15 hear the click. Do you hear any sounds of the other gun?

16 MORGADO: I hear his -no. Well, I hear a couple gunshots
17 still going off.

18 GAN: From the other gun? Not Dennis' gun?

19 MORGADO: Right. What I thought was the other gun because
20 it was a lower - a lower gunshot.

21 GAN: Right. And that's after you heard some clicks from
22 Dennis' gun?

23 MORGADO: Right.

24 GAN: Okay. Or you heard some clicks going. It could be
25 Dennis' gun.

26 MORGADO: It could be Dennis' gun, right.

27 GAN: Yeah, but you did hear some firing of the gun with a
28 different sound than what you believe was Dennis' gun.

1 MORGADO: Right.

2 GAN: Okay. And [unintelligible] because -I'm assuming the
3 first round you heard that -when you first pulled in front of
4 that suspect, is what you believe was the suspect's weapon being
5 fired?

6 MORGADO: Right.

7 GAN: So, you heard that sound-

8 MORGADO: Right.

9 GAN: And you heard another sound that you believe was-

10 MORGADO: Dennis.

11 GAN: So that's how we know what sounds we're talking about.

12 MORGADO: Right.

13 GAN: Okay. So you're at the car, ah, you hear a couple
14 more, at least a couple more that we know of the other gun being
15 fired.

16 MORGADO: Um hmm.

17 GAN: And then what happened?

18 MORGADO: I heard Dennis yelling something. Um, I don't
19 know what he was saying at that point. I said, Dennis, take
20 cover, take cover. And ah, I didn't know where he was at that
21 time. I knew he was off to the right-hand side somewhere because
22 of I dropped him off but I didn't know if he was still up at that
23 van or if he was back further. I had no idea where he was at.
24 Ah, [unintelligible] and I see him, you know, that first sight
25 was behind the vehicle where I was at.

26 GAN: Okay. And you guys ask- he says, are you okay?

27 MORGADO: Right.

28 GAN: Have you been shot, something to that effect.

1 MORGADO: Right.

2 GAN: Um, now -okay. Okay. Um, you know when you're
3 crawling along in the car and- and you were across the street and
4 something ricochets of the ground-

5 MORGADO: I was in the middle of the street.

6 GAN: You're in the middle of the street.

7 MORGADO: Yeah.

8 GAN: And which way were those going? Could you tell where
9 they were going?

10 MORGADO: They were going toward me 'cause they- when they
11 were hitting, I could see the red- you know, the ah, spark off
12 the cement up and over. In front of me.

13 GAN: Was it hitting the street?

14 MORGADO: They were hitting the street.

15 GAN: They were hitting the street.

16 MORGADO: Yeah.

17 GAN: So, where do you believe those were coming from?

18 MORGADO: Ah, I - I don't know. I - I believe it was the
19 guy shooting at me still.

20 GAN: Okay, well let's do this, like kind of what direction,
21 we're talking about. I'll draw this out. Here's Taraval.

22 MORGADO: Um hmm.

23 GAN: Here's 48th. Here's lower Great. So, you went what?
24 North up here, right?

25 MORGADO: No. Down here.

26 GAN: I can draw in that minivan.

27 MORGADO: Minivan was about here. I don't know. I think it
28 was like three or four out.

1 GAN: Yeah. Yeah. It's all parking here. Ah, and then the
2 car you were behind about?

3 MORGADO: Directly across.

4 GAN: Okay. Then do a line with an arrow in which way you
5 think those ricochets were going.

6 MORGADO: The ricochets were coming this way. And I think-
7 'cause when I was crawling, I got out here and I came straight
8 this way like this.

9 GAN: And put a little "x" where you were at on that car.

10 MORGADO: On the corner there.

11 GAN: Yeah. Okay. Kinda like a -

12 MORGADO: Yeah.

13 GAN: Okay. Ah, okay so, [unintelligible]. From the time
14 it took you - at the- when you got behind that car across the
15 street, behind the engine block, how long was it before your
16 partner got behind the car with you?

17 MORGADO: Um, I mean if -it was pretty quick.

18 GAN: Um hmm.

19 MORGADO: Ah, maybe, you know, five seconds. It was pretty
20 quick.

21 GAN: Okay. It was fairly quick.

22 MORGADO: Yeah. Everything happened really quick.

23 GAN: We're not talking minutes here. We're talking-

24 MORGADO: Yeah.

25 GAN: Because everything is moving fast.

26 MORGADO: Right.

27 GAN: Okay. So, you guys get behind a car. You guys both
28 check to make sure each other is okay.

1 MORGADO: Right.

2 GAN: Um, then what happened?

3 MORGADO: Um, Dennis says- he's running. I get up and he
4 was still fumbling um, with his gun. I think he was doing a
5 reload.

6 GAN: Dennis was.

7 MORGADO: Dennis was.

8 GAN: Okay.

9 MORGADO: Um, I look up over, I don't see anybody here and I
10 don't see anybody running northbound. Um, and then the- this car
11 was obstructing some of my view this way.

12 GAN: That car he was behind.

13 MORGADO: Was behind.

14 GAN: Yeah.

15 MORGADO: Couldn't really see this way. And then Dennis
16 starts yelling, he's running up Taraval, running up Taraval. Um,
17 automatically- after he says that, Dennis takes off running.

18 GAN: Okay.

19 MORGADO: This way in front- from the back of the vehicle
20 this way, up to Taraval.

21 GAN: Okay.

22 MORGADO: And then eastbound Taraval.

23 GAN: And what do you do?

24 MORGADO: I look over and I see Dennis' two magazines.

25 GAN: And where are they at?

26 MORGADO: They're on the - they're right by the tire on the
27 curb behind the ah, vehicle on this side.

28 GAN: On the ah, on the curb side of the-

1 MORGADO: On the curb side of this vehicle.

2 GAN: That's where he had two magazines on the ground?

3 MORGADO: Two magazines on the ground.

4 GAN: Okay.

5 MORGADO: I grabbed them, look at them- one is still full.

6 The other one it appeared to be empty.

7 GAN: Um hmm.

8 MORGADO: Um, at that time, I thought he maybe holstered an

9 empty mag. So, I grabbed his- I grabbed both magazines. After

10 that, ran back to the car, grabbed the keys and then ran - ran in

11 front of this car this way.

12 GAN: In front of that minivan?

13 MORGADO: Yeah.

14 GAN: Okay.

15 MORGADO: Looked back, saw that this car was all shot out,

16 the windows.

17 GAN: Okay.

18 MORGADO: Um, kept running and then I see Dennis up at 47th

19 when I'm turning the- turning the corner and then I'd say about

20 fifty feet in, I spot Dennis up at 47th.

21 GAN: At the corner of 47th and-

22 MORGADO: At the corner of 47th and Taraval.

23 GAN: And Taraval?

24 MORGADO: Um-

25 GAN: Was he with any other officers at the time?

26 MORGADO: Ah, yeah. When I'm - when I'm actually running, I

27 get the keys and I'm running - excuse me. When I'm running this

28 way to the car to grab the keys, a unit flies by this way.

1 GAN: Down 48th?
2 MORGADO: Down 48th to Taraval.
3 GAN: Okay.
4 MORGADO: And then they come up this way and then made a
5 left -when I rounded the corner, I see them making a left and you
6 can hear-
7 GAN: Onto 47th?
8 MORGADO: Right. And I heard Dennis, you know, screaming,
9 you know, he's got a 221, he's got a 221. And ah, so then those
10 officers took cover.
11 GAN: Do you know who those officers were?
12 MORGADO: Palma and [Hegel].
13 GAN: Okay. Okay. So now you eventually turn the corner
14 onto Taraval from 48th?
15 MORGADO: Correct.
16 GAN: Okay. And what happened then?
17 MORGADO: Um, again, I see Dennis behind a vehicle on the
18 opposite side of 47th, on the eastside of 47th, um, hugging the
19 building line and then he's calling, saying that there's a
20 suspect behind some vehicle. I don't know if he gave a
21 description of the vehicle or not but he said the guy's behind
22 the vehicle. So, then we took cover- me, Officer Palma and I
23 don't know where Hegel was at that time, take cover on the
24 westside of 47th.
25 GAN: Um hmm.
26 MORGADO: Until other officers got there and then we closed
27 down the perimeter.
28 GAN: Okay. And then what happened? I mean more units

1 arrived, I guess?

2 MORGADO: More units arrived. Um, then ah, when more units
3 arrived, they -the - the Sergeants were having people, you know,
4 shut down the corner. I know an Ingleside unit flew by me. I
5 told them to stay on the lower Great Highway and ah, Taraval.
6 And that my vehicle was there and that's where the crime scene
7 began. So, they - they - they went there and started securing
8 from what I know, my vehicle. Um, and then after that,
9 paramedics came and brought the ambulance [unintelligible].

10 GAN: Yeah, I see you have injuries on your hand.

11 MORGADO: Hands, knees and elbow.

12 GAN: Is that from getting out of the car and -

13 MORGADO: Yeah.

14 GAN: Running for your life and crawling onto safety and
15 getting cover?

16 MORGADO: Yep.

17 GAN: Okay. All right. Ah, Mike?

18 PHILPOTT: Nothing.

19 GAN: [Unintelligible]?

20 FEMALE: No.

21 GAN: Joe?

22 MALE: Nothing.

23 GAN: All right. Well, the last thing is I'm gonna show you
24 a photospread. And I'm sure you heard that, you know, somebody
25 was taken into custody. It may be the person. It may not. You
26 know how that goes. The form that you have read to everybody in
27 your life, but now you have to actually read it. If I can find
28 it. I'll do the rest. Do you recognize anybody? If you do, you

1 do. You don't, you don't.

2 MORGADO: In-between those.

3 GAN: Between three and five?

4 MORGADO: Yeah.

5 GAN: What makes you say between three and five?

6 MORGADO: 'Cause I don't remember seeing that straight of
7 hair.

8 GAN: On, like on number one?

9 MORGADO: Yeah.

10 GAN: Okay. Going by hair, anything else?

11 MORGADO: Same color [unintelligible] he's kinda lighter.

12 GAN: A little bit lighter?

13 MORGADO: Yeah.

14 GAN: [Unintelligible].

15 MORGADO: Yeah.

16 GAN: Photograph should [unintelligible]. Okay. Can you-
17 but you're saying it's the hair?

18 MORGADO: Yeah.

19 GAN: Between three and five?

20 MORGADO: Yep.

21 GAN: All right. Just kinda like write that down on the
22 bottom. Ah, just say, recognized by - or, you know, hair or
23 however you want to say it and then sign your name to it. Okay.
24 And go ahead and sign the ah, this drawing [unintelligible].
25 Okay. Anything else? Anything else you want to add or anything
26 or anything you think I forgot to ask or-?

27 MORGADO: No.

28 GAN: No? Okay. Very good. All right. Ending time is ah,

1 08:50.

2 **END OF DOCUMENT**

3

4

5

6

7

8

9

10

11

12

13

14

15

16

17

18

19

20

21

22

23

24

25

26

27

28

1 DEPARTMENT OF POLICE ACCOUNTABILITY

2 DPA CASE NO.: 0662-08

3

4 INTERVIEW OF: OFFICER DENNIS CRAVALHO, #1783

5 DATE OF INTERVIEW: 06/18/2009

6

7

8 SR. INV. DENNIS MAXON: All right. This interview is
9 regarding OCC Case Number 0662-08. It's taking place on June
10 18th, 2009 at the OCC. It is about five minutes after 12:00.
11 Conducting the interview is Senior Investigator Dennis Maxon.
12 Also [unintelligible]. The member being interviewed is Officer
13 Dennis Cravalho, Star Number-

14 OFC. DENNIS CRAVALHO: 1783.

15 SR. INV. MAXON: Okay. And his attorney is?

16 ATTY LIDIA STIGLICH: Lidia Stiglich.

17 SR. INV. MAXON: Officer Cravalho, have you read the
18 statement of [REDACTED] ID [REDACTED] ?

19 OFC. CRAVALHO: Yes, I have.

20 SR. INV. MAXON: Concerning an incident at you said
21 lower Great Highway on May 19th, 2007. Have you read General
22 Order 2.08?

23 OFC. CRAVALHO: Yes, I have.

24 SR. INV. MAXON: Have you read Rule 21, General Order
25 2.01?

26 OFC. CRAVALHO: Yes, I have.

27 SR. INV. MAXON: Have you read Section 1(a) of General
28 Order 2.04?

1 OFC. CRAVALHO: Yes, I have.

2 SR. INV. MAXON: Do you understand these orders?

3 OFC. CRAVALHO: Yes, I do.

4 SR. INV. MAXON: Are you prepared to be interviewed at
5 this time?

6 OFC. CRAVALHO: Yes, sir.

7 SR. INV. MAXON: Here we go. So let's just start at the
8 beginning. What was your assignment that night?

9 OFC. CRAVALHO: I was the patrol over the Sunset area.

10 SR. INV. MAXON: All right, so you were in a radio car?

11 OFC. CRAVALHO: Yes, I was in a marked patrol car.

12 SR. INV. MAXON: Marked patrol car, and you were in full
13 uniform?

14 OFC. CRAVALHO: Yes, I was.

15 SR. INV. MAXON: Did you have a partner in your car?

16 OFC. CRAVALHO: Yes, I did.

17 SR. INV. MAXON: And who was that?

18 OFC. CRAVALHO: Officer Paulo Morgado.

19 SR. INV. MAXON: And who was driving?

20 OFC. CRAVALHO: He was.

21 SR. INV. MAXON: He was, okay. What brought your
22 attention to this situation?

23 OFC. CRAVALHO: We got dispatched to it via radio.

24 SR. INV. MAXON: What was the narrative of the dispatch?

25 OFC. CRAVALHO: What they stated was a burglary in process
26 out of a garage.

27 SR. INV. MAXON: And did you get a description of the
28 subject?

1 OFC. CRAVALHO: Yes, we did.

2 SR. INV. MAXON: And what was that?

3 OFC. CRAVALHO: It was so long ago. It was a Hispanic male-
4 dark hair, and it stated he was ridin' a bicycle.

5 SR. INV. MAXON: So what did you do?

6 OFC. CRAVALHO: Proceeded to the area that they dispatched
7 to, which was I think it was lower Great Highway, and I think at
8 the time the call came out, it was let me see--I'm trying to
9 think of the streets--go alphabetically. [I think] Taraval. He
10 was approaching Santiago from Great Highway.

11 SR. INV. MAXON: And what happened next?

12 OFC. CRAVALHO: A primary unit actually picked up the call,
13 and primary meaning they dispatched another unit to the call. We
14 actually backed them up. And we proceeded down Great Highway
15 northbound, and we were coming from I want to say Sloat.

16 SR. INV. MAXON: Right.

17 OFC. CRAVALHO: And as the dispatcher kept putting out the
18 description and direction, because they stated that I guess the
19 victim was following the suspect who broke into the garage. We
20 approached Taraval and Great Highway, and we noticed a gentleman
21 fitting the description riding his bicycle in the middle of the
22 street going southbound on lower Great Highway. He saw us. He
23 immediately went up onto the sidewalk. My window was down at the
24 time. I advised to my partner--stated I think that's him, fits
25 the description. So we pulled up alongside of him. He was on
26 the sidewalk. Asked him to stop. I said hey, can you stop? I
27 want to talk to you. Just then he took off on the bicycle still
28 up on the sidewalk going southbound. My partner put the car in

1 reverse, which we caught up to him backwards--I would say maybe
2 ten fifteen feet from Taraval. I again yelled at him. I stated
3 stop, get off the bike, I want to talk to you. He got off the
4 bike, and proceeded to run, which I thought--I immediately exited
5 my vehicle, jumped out of the car, and I came around a minivan
6 that was parked, and when I came around, he was crouched down by
7 the front tire. At this time, I already advised my dispatch
8 that I was in foot pursuit, which I thought. So when I came
9 around, I didn't know what he was doin'. I had my service
10 revolver pulled out. Stated in my dispatch that I had one at
11 gunpoint. He never knew I was behind him--never. Even--he was
12 more focused on the patrol car, so when the patrol came around,
13 and pulled into the front of the minivan, now facing westbound,
14 and kind of like [block his path] from taking off. As soon as
15 he saw that, he jumped up and just lit up the car with fire. As
16 soon as that happened, I started yellin' over the air, and I
17 returned fire, and I still remember the look he gave me, 'cause
18 he turned around, and kind of looked at me like where the "f"
19 did you come from. He never knew I got out of the car. But
20 they're saying that's pretty much what saved our lives, because
21 he actually put three bullet holes in the door, in one--in the
22 passenger door where I was sitting, and then one in the front
23 window. So thinking my partner was in the car dead, I'm yellin'
24 over the air, and I'm returning fire. Well when he turns and
25 looks at me, he stands up, or he's actually already standing up.
26 He turns around, and starts runnin' at me shooting. Not a lot
27 space between a minivan. There was no place to hide, so I
28 crouched to one knee, and I'm trying to return fire. My service

1 | revolver goes empty, which I thought. Later I found out that
2 | when I was returning fire, my finger hit the magazine release,
3 | and it released the magazine about maybe an inch or two, so it
4 | wasn't engaging, so I thought it was empty. He kept comin' at
5 | me. I kept swearing I hit him. I go for cover, as he got
6 | closer, and when I dove, I dove behind the minivan, where there
7 | was broken glass everywhere. I ended up blowin' out my knee
8 | when I landed, because I landed straight on my knee, and I ended
9 | up cutting up all of my arm, because I landed on the broken
10 | glass. He came over the top of me, and I thought he was going to
11 | shoot me, but for some reason, he didn't. I started rolling in
12 | the middle of the street. I got up and I dove over a parked car.
13 | Went sliding over the hood, came up to the other side, and when
14 | I came up to the other side, there was my partner. So I asked
15 | him if he was hit. He said no. He asked me if I was hit. I
16 | said no. I got up. I reloaded, watched him run westbound up on
17 | Taraval, so I came runnin' up behind him, as I'm screaming over
18 | the radio. Still returning fire, because he's [turnin'] at me.
19 | I see a patrol car comin' down Taraval westbound. He turns
20 | northbound onto [47th]. I come up behind, and I turn onto 47th
21 | and he's gone. And there was no way that he could've took off on
22 | me, because I was right behind him. So I'm like okay, I'm not
23 | going to get ambushed again. So I waited and set up a perimeter.
24 | Everybody came out, and I would say maybe—I was made to leave
25 | the scene, because I had blood all over me. They thought I was
26 | hit and everything. So medics came out and took me to the
27 | hospital. I heard later they found him about maybe two to three
28 | hours later. They found him hiding in some bushes, and he still

1 had the firearm on him. And they looked at it, and they said the
2 reason why he couldn't shoot me was because one of my rounds
3 actually broke the magazine that was in the firearm that he had.

4 SR. INV. MAXON: Wow! So you said that you went—dove
5 over the car. That was not the patrol car.

6 OFC. CRAVALHO: No, no it was our parked car that was across
7 the street. 'Cause for him not to get a single shot at me, I
8 was rolling in the street on Great Highway. And I rolled almost
9 all the way across the street. Luckily there wasn't any cars
10 comin', because it was late at night—about 1:00/1:30. So luckily
11 nobody took me out while they were drivin' by. But I was
12 sensible enough to get up and jump over a car. So
13 [unintelligible] alive and well, which I thought he was actually
14 in the patrol car at the time.

15 SR. INV. MAXON: So he had gotten out of the car.

16 OFC. CRAVALHO: What happened was, he had—I found out later
17 that when he started shootin' at the car, my partner fell out,
18 or jumped out, but landed on the ground? The car rolled and hit
19 the building, and he ended up doin' an army crawl with I guess
20 rounds still going off. So he was able to get up and run to the
21 other side of the street.

22 SR. INV. MAXON: That pretty much tells the story. So
23 the statement is that you came up behind him. He didn't see
24 you, but he had already started firing at the patrol car.

25 OFC. CRAVALHO: As soon as he saw a patrol car take position
26 in front of that minivan, he just popped up, and just started
27 goin' off on the patrol car. When I mean going off, I mean
28 shooting at the patrol car.

1 SR. INV. MAXON: So how many rounds do you think you
2 fired?

3 OFC. CRAVALHO: I couldn't—I couldn't even guess.

4 SR. INV. MAXON: Did you put in more than one—carry more
5 than one clip?

6 OFC. CRAVALHO: Well that was thing like I said, I thought I
7 had emptied a clip, but like I said, it disengaged about an inch
8 or so. So when I reloaded, I dropped that clip on the ground and
9 reloaded it with another magazine. I couldn't tell you. It's
10 just everything just happened so quick, that I couldn't even
11 count.

12 SR. INV. MAXON: Your weapon was functioning okay?

13 OFC. CRAVALHO: Oh yes.

14 SR. INV. MAXON: No problems.

15 OFC. CRAVALHO: No, not at all.

16 SR. INV. MAXON: Did you notice if he was wounded at
17 all? Could you see?

18 OFC. CRAVALHO: No. Could not. I mean the way that he was
19 comin' at me, I actually thought he was wearing a vest or
20 somethin', 'cause I know I hit him being that close, 'cause I
21 was at the back of the minivan. He was in the front, and with
22 nothin' between us. So it was interesting to find out later
23 where the rounds went.

24 SR. INV. MAXON: So after they—you went to the hospital,
25 what happened to you?

26 OFC. CRAVALHO: I ended up going into surgery, and I was
27 almost—I was almost out a whole year.

28 SR. INV. MAXON: That was on your knee?

1 OFC. CRAVALHO: Yes.

2 SR. INV. MAXON: Did you go to Homicide that night? Did

3 they-

4 OFC. CRAVALHO: Yes, they took me there that--after I was

5 released from the hospital, they took me there that same night.

6 SR. INV. MAXON: Directly to Homicide, or to the station

7 first?

8 OFC. CRAVALHO: No.

9 SR. INV. MAXON: They interviewed there?

10 OFC. CRAVALHO: Yes.

11 SR. INV. MAXON: All right. I think that about covers my

12 questions. I don't think I really have anything else. Counselor

13 do you have anything?

14 ATTY STIGLICH: No.

15 SR. INV. MAXON: This concludes the interview at 12:17.

16 Thank you very much, Officer.

17 OFC. CRAVALHO: Thank you.

18 **END OF DOCUMENT**

19

20

21

22

23

24

25

26

27

28